

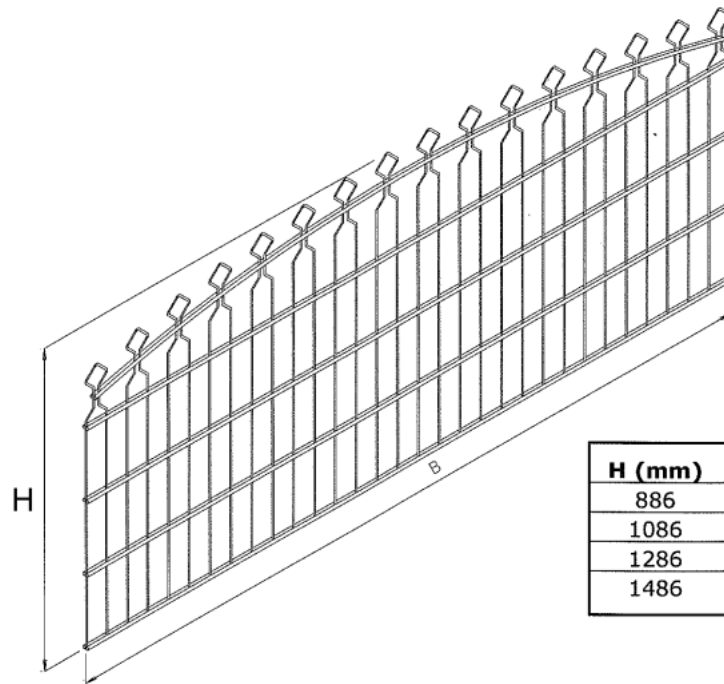

# **NEW Decofor**

MONTAGEHANDLEIDING  
NOTICE DE POSE  
ASSEMBLY MANUAL  
MONTAGEANLEITUNG  
MANUALE DI POSA  
INSTRUCCIONES DE MONTAJE

Onderdelen  
 Accessoires  
 Accessories  
 Zubehör  
 Accessori  
 Accesorios



H (mm)
886
1086
1286
1486

H (mm)	L (mm)
886	1500
1086	1500
1286	1750
1486	2000

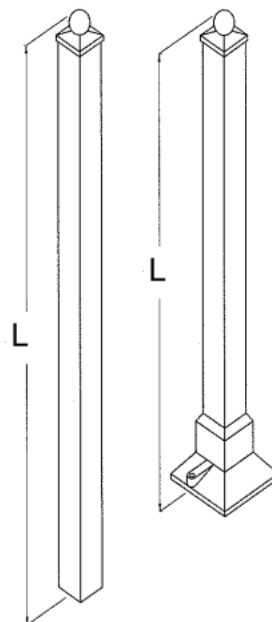

H (mm)	L (mm)
886	920
1086	1120
1286	1320
1486	1520

- Tussenpaal beugel
- Collier poteau intermédiaire
- Intermediate post collet
- Zwischen-Pfosten Schelle
- Staffa per palo intermedio
- Arco poste intermedio

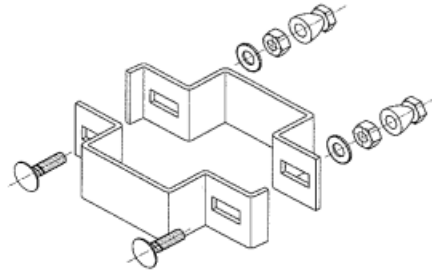

- Hoekpaal beugel
- Collier poteau d'angle
- Corner post collet
- Eck-Pfosten Schelle
- Staffa per palo d'angolo
- Arco poste ángulo

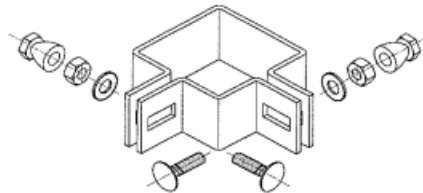

- Eindpaal beugel
- Collier poteau initial
- End post collet
- End-Pfosten Schelle
- Staffa per palo iniziale/finale
- Arco poste de extremo

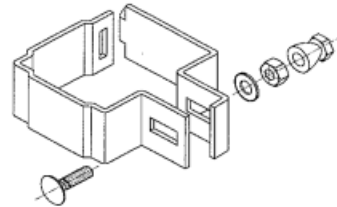

- Poortpaalklem
- Fixation sur poteau portail
- Gate post fixation
- Tor-Pfostenbefestigung
- Morsetto per palo di cancello
- Fijación sobre postes de puertas

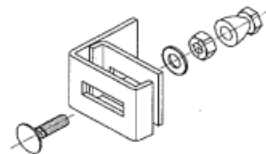

- Muurklem
- Fixation contre mur
- Wall fixation
- Mauerbefestigung
- Morsetto a muro
- Fijación mural

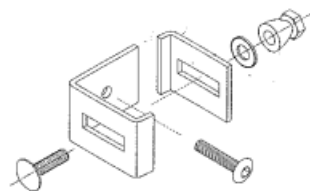

**Installatie panelen**  
**Installation des panneaux**  
**Panel fence installation**  
**Matten-Installation**  
**L'impianto di pannelli**  
**Instalación des los paneles**

Panelen in lijn  
 Installation clôture en ligne droite  
 Straight line panel fence  
 Gerade Matten-Installation  
 Pannelli alla pari per l'impianto direzione in linea retta  
 Paneles en linea recta

*Decofor Arco*

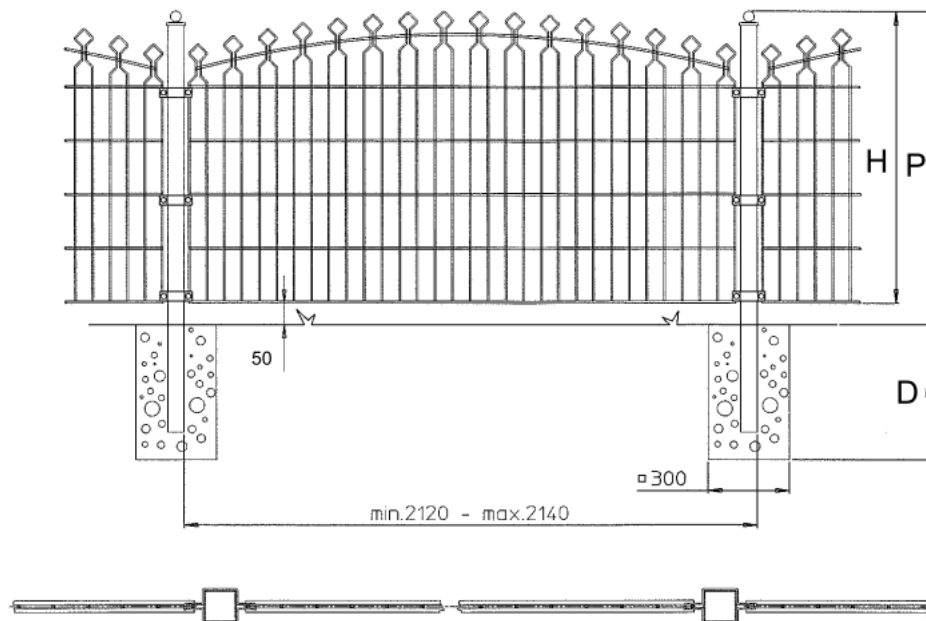

H (mm)	P (mm)	D (mm)
886	966	600
1086	1166	500
1286	1366	500
1486	1566	500

*Decofor Recto*

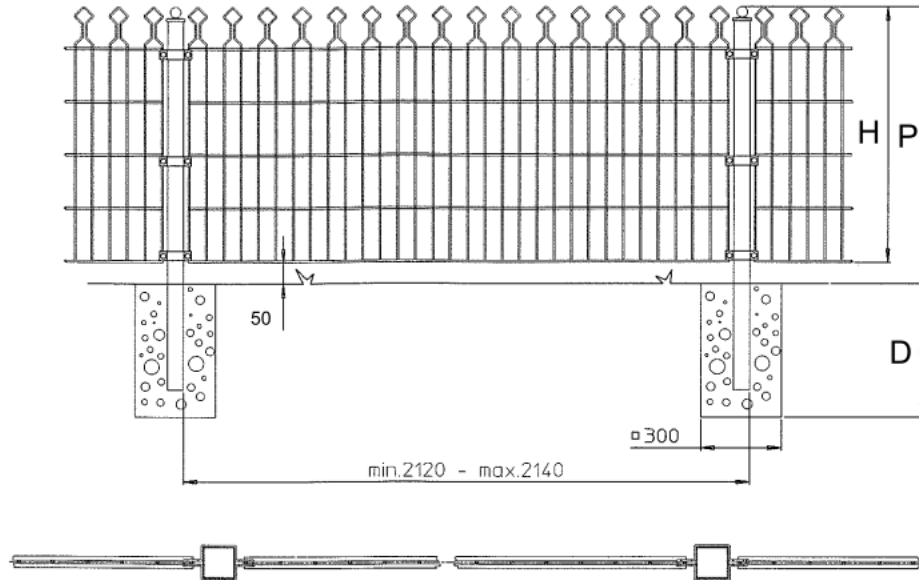

H (mm)	P (mm)	D (mm)
842	762	600
1042	962	600
1242	1162	600
1442	1362	600

Panelen in hoek  
Clôture panneaux sous angle  
Panel fence under angle  
Matteninstallation Ecklösung  
Pannelli sotto angolo  
Paneles en ángulo

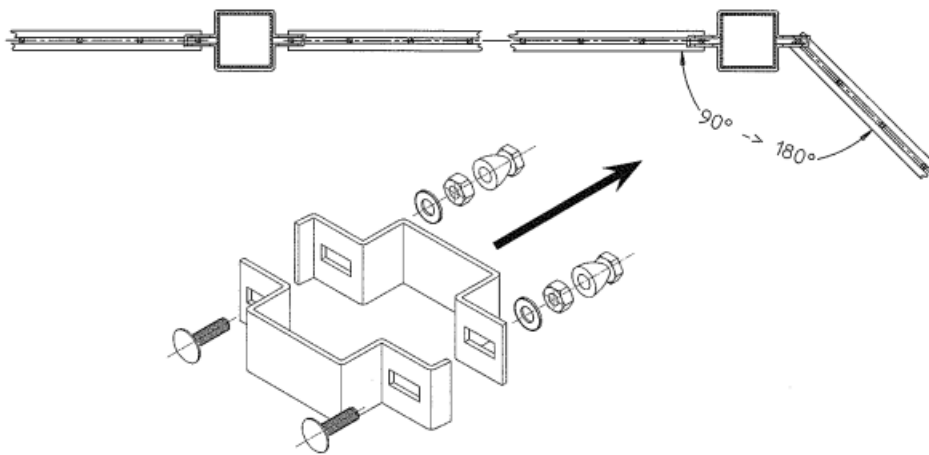
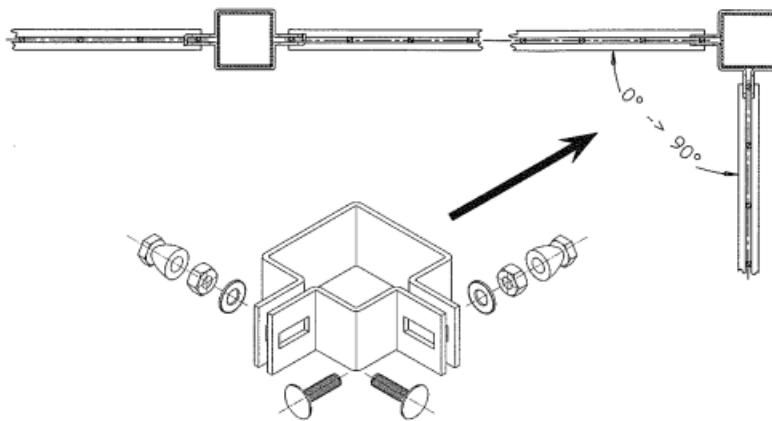

Panelen met hoogteverschillen  
Panneaux sur terrain en pente  
Panels on slopes  
Matten mit Höhenausgleich  
Pannelli su terreno a pendio  
Paneles para terreno inclinado

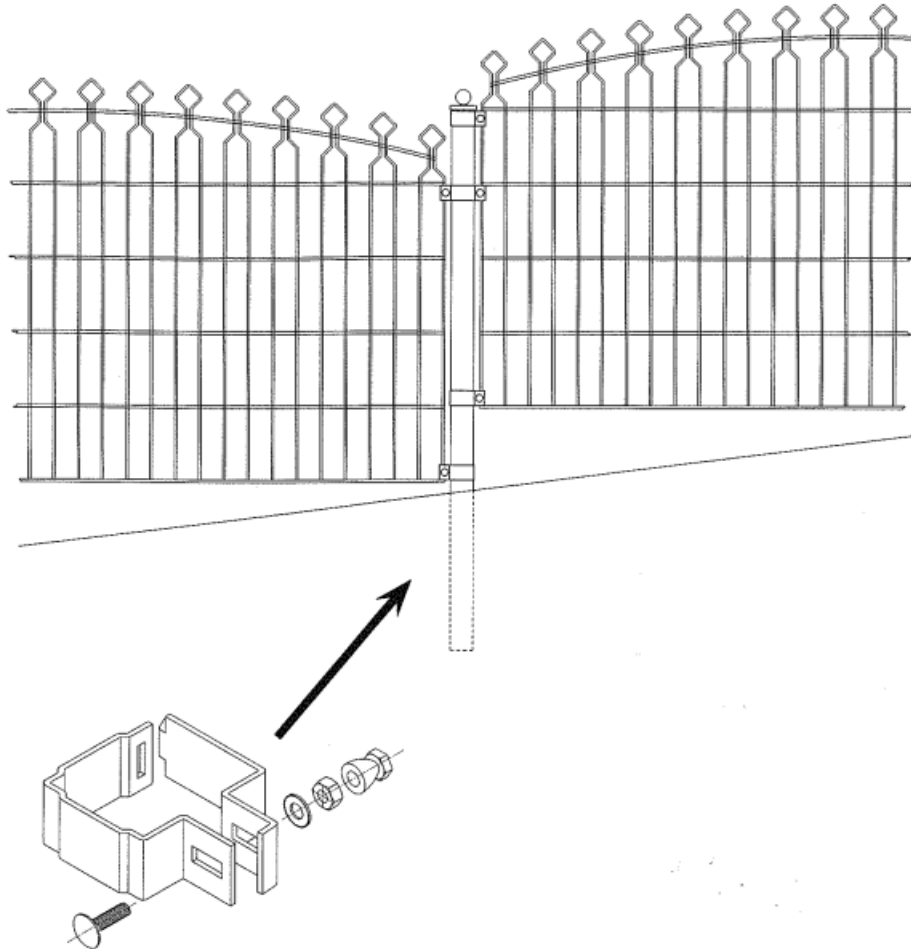

Inkorten panelen  
Raccourcir panneaux  
Shorten panels  
Matten zuschneiden  
Raccorciare pannelli  
Acortar paneles

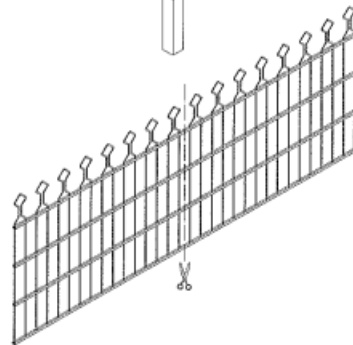
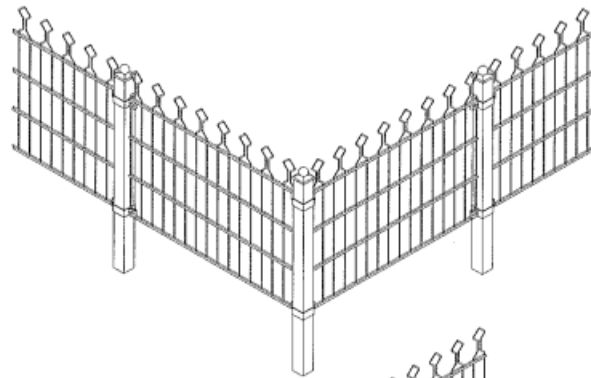
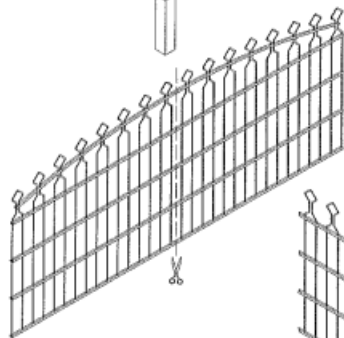
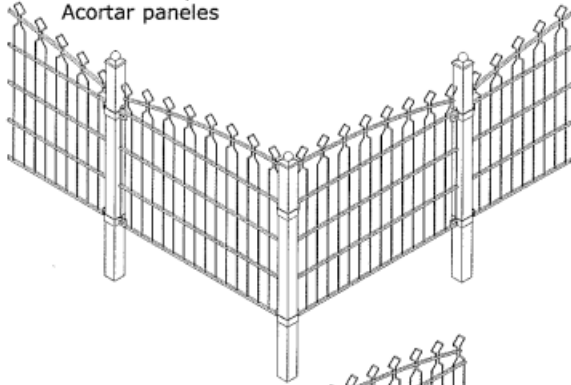



Panelen tussen muurkolommen  
 Panneaux entre pilastres  
 Panels between pilasters  
 Matte zwischen Mauerpfeilern  
 Pannelli fra pilastri  
 Paneles entre pilastras

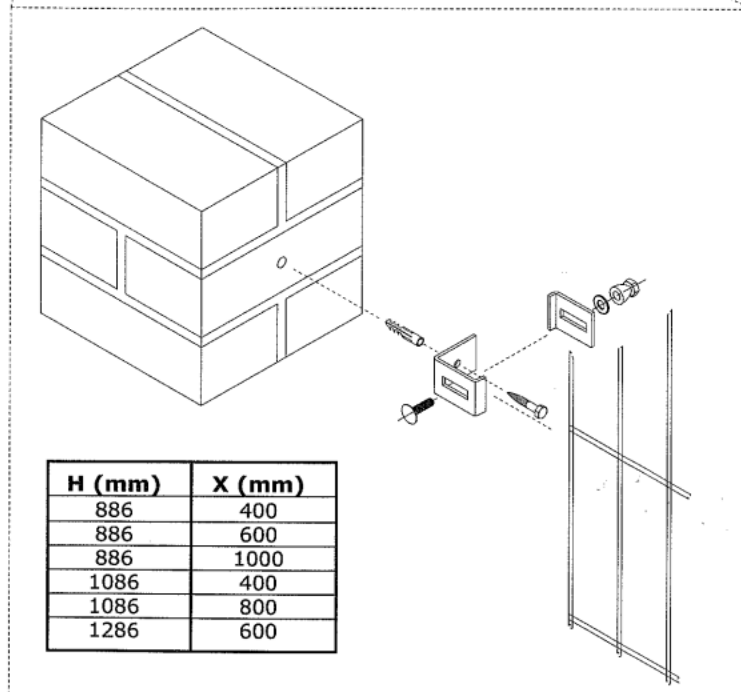
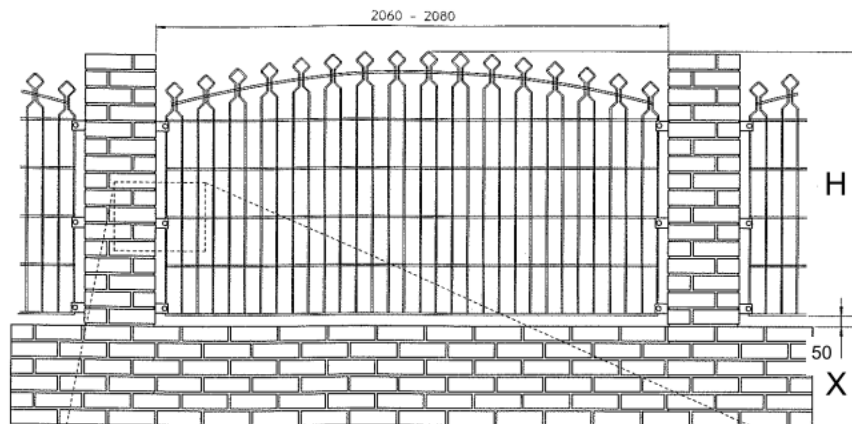

H (mm)	L (mm)
1086	1500
1286	1800
1486	2000
1886	2500

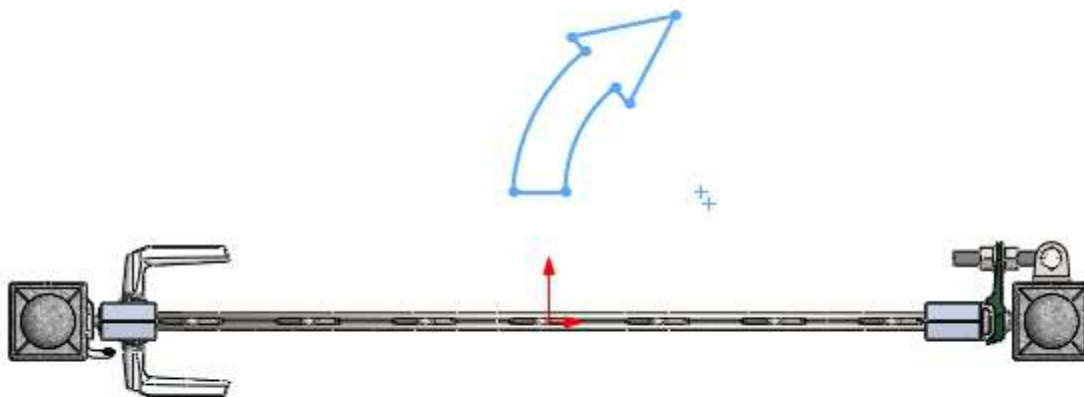

Enkele poort + panelen + palen in beton  
 Portillon + panneaux + poteaux à sceller  
 Single gâtes + panels + posts in concrete  
 Einflügeliges Tor + Matten + Pfosten zum Einbetonieren  
 Cannelo ad uno battente + pannelli + pali in calcestruzzo  
 Puertas simples + paneles + postes en el hormigón

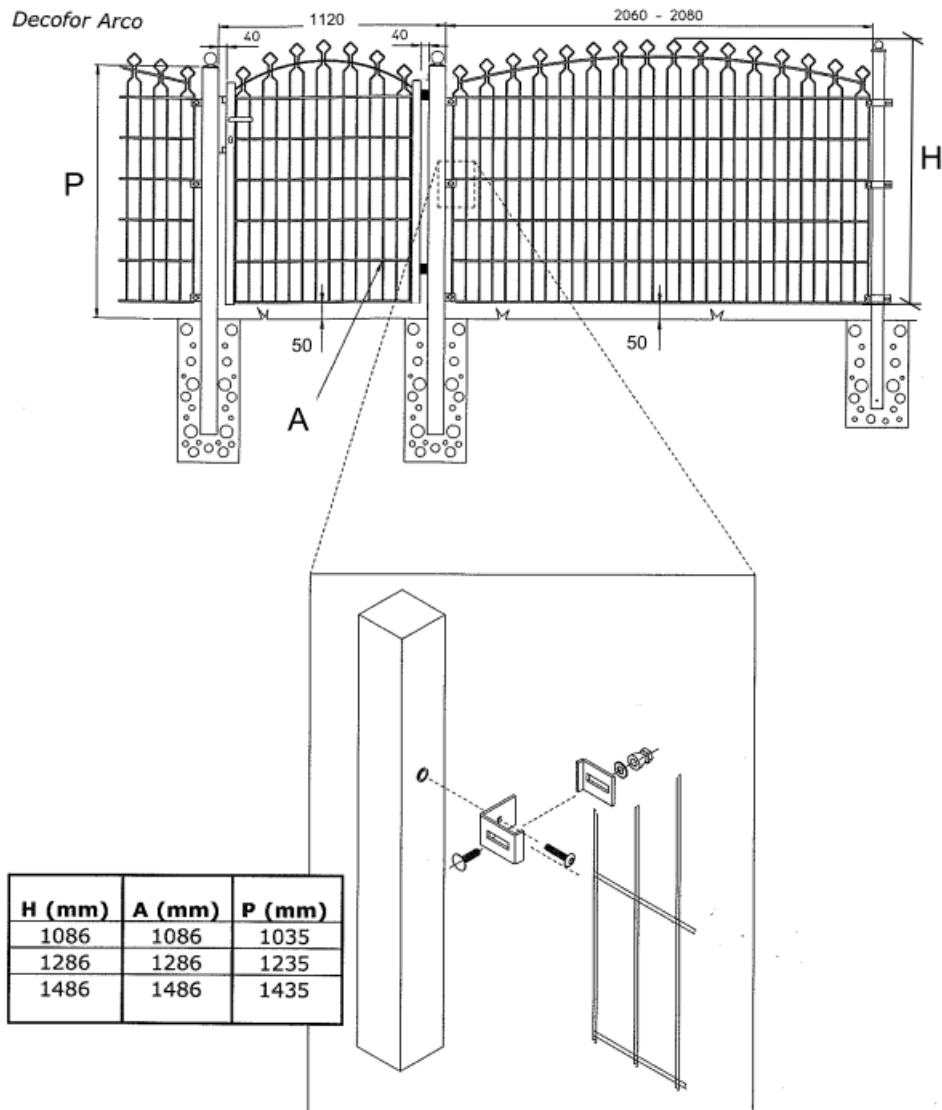

*Decofor Recto*

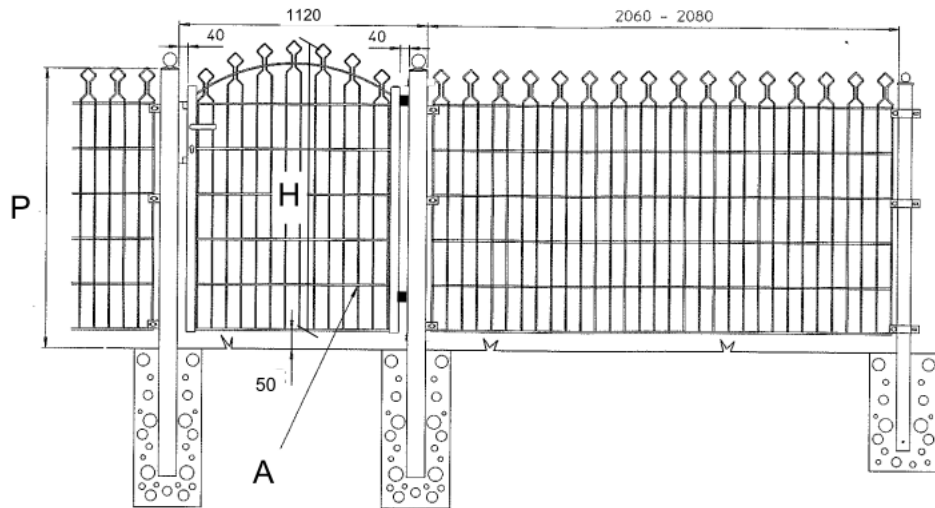

Enkele poort + panelen + païen met alu-voet  
Portillon + panneaux + poteaux avec platine alu  
Single gates + panels + posts with alu-floorplate  
Einflügeliges Tor + Matten + Pfosten mit Alu-Bodenplatte  
Cancello ad uno battente + pannelli + pali con piastra di base in alluminio  
Puertas simples + paneles + postes con place en aluminio

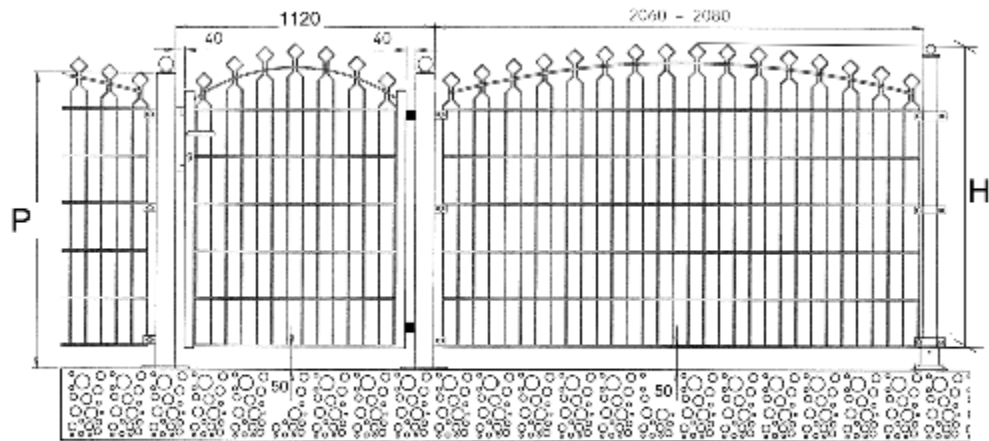

Enkele poort + panelen op muur + païen met alu-voet  
 Portillon + panneaux sur mur + poteaux avec platine alu  
 Single gates + panels on wall + posts with alu-floorplate  
 Einflügeliges Tor + Matten auf Mauer + Pfosten mit Alu-Bodenplatte  
 Cannelo ad uno battente + pannelli su muro + pali con piastra di base in alluminio  
 Puertas simples + paneles sobre muro + postes con place en aluminio

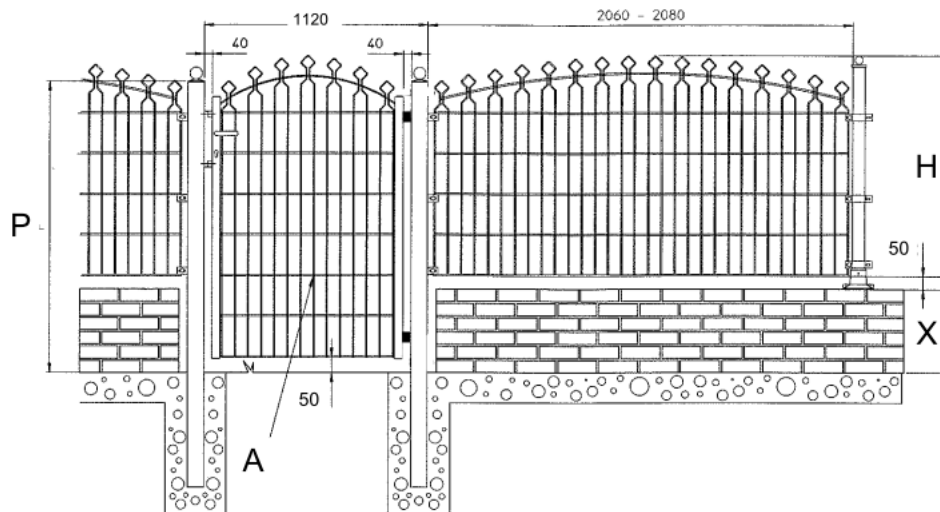

H (mm)	X (mm)	A (mm)	P (mm)
886	400	1286	1235
886	600	1486	1435
886	1000	1886	1835
1086	400	1486	1435
1086	800	1886	1835
1286	600	1886	1835
1486	400	1886	1835

Enkele poort + panelen tussen muurkolommen Portillon + panneaux entre pilastres  
 Single gates + panels between pilasters Einflügeliges Tor + Matten  
 zwischen Wandpfeilern Cannello ad uno battente + pannelli fra colonne  
 Puertas simples + paneles entres pilastras

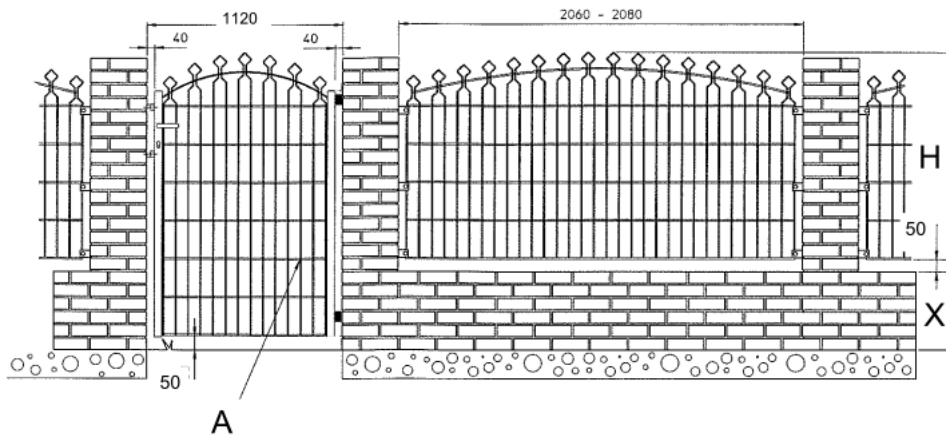

H (mm)	X (mm)	A (mm)
886	400	1286
886	600	1486
886	1000	1886
1086	400	1486
1086	800	1886
1286	600	1886
1486	400	1886

Montage Scharnieren enkele poort  
Montage charnières pour portillon  
Hinge assembly single gate  
Montage der Scharniere für ein einflügeliges Tor  
Montaggio cerniere al cancello ad uno battente  
Montaje bisagras puerta simple

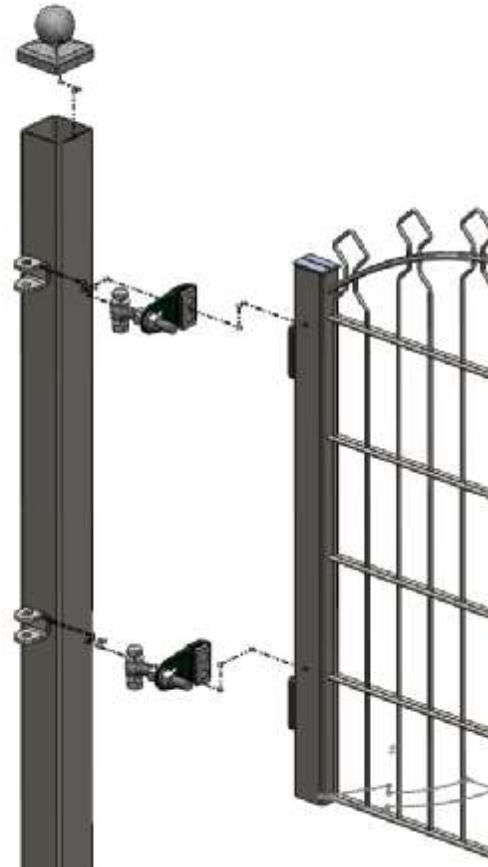

Montage muurscharnier enkele poort  
Montage charnière pour portillon pour mur  
Wall hinge assembly single gate  
Montage der Scharniere für Mauerbefestigung  
Montaggio cerniera murale al cancello ad uno battente  
Montaje bisagra mural puerta simple

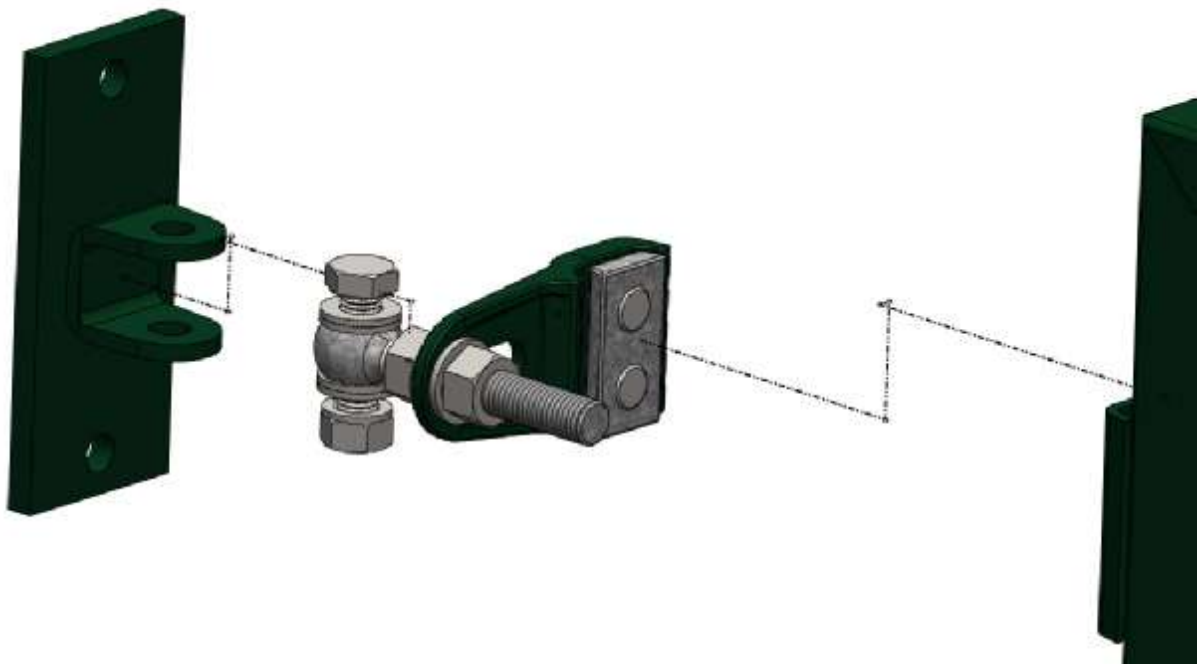



Montage siot enkele poort  
Montage serrure pour portillon  
Lock assembly single gate  
Montage des Schlosses für ein einflügeliges Tor  
Montaggio serratura al cancello ad uno battente  
Montaje cerradura puerta simple

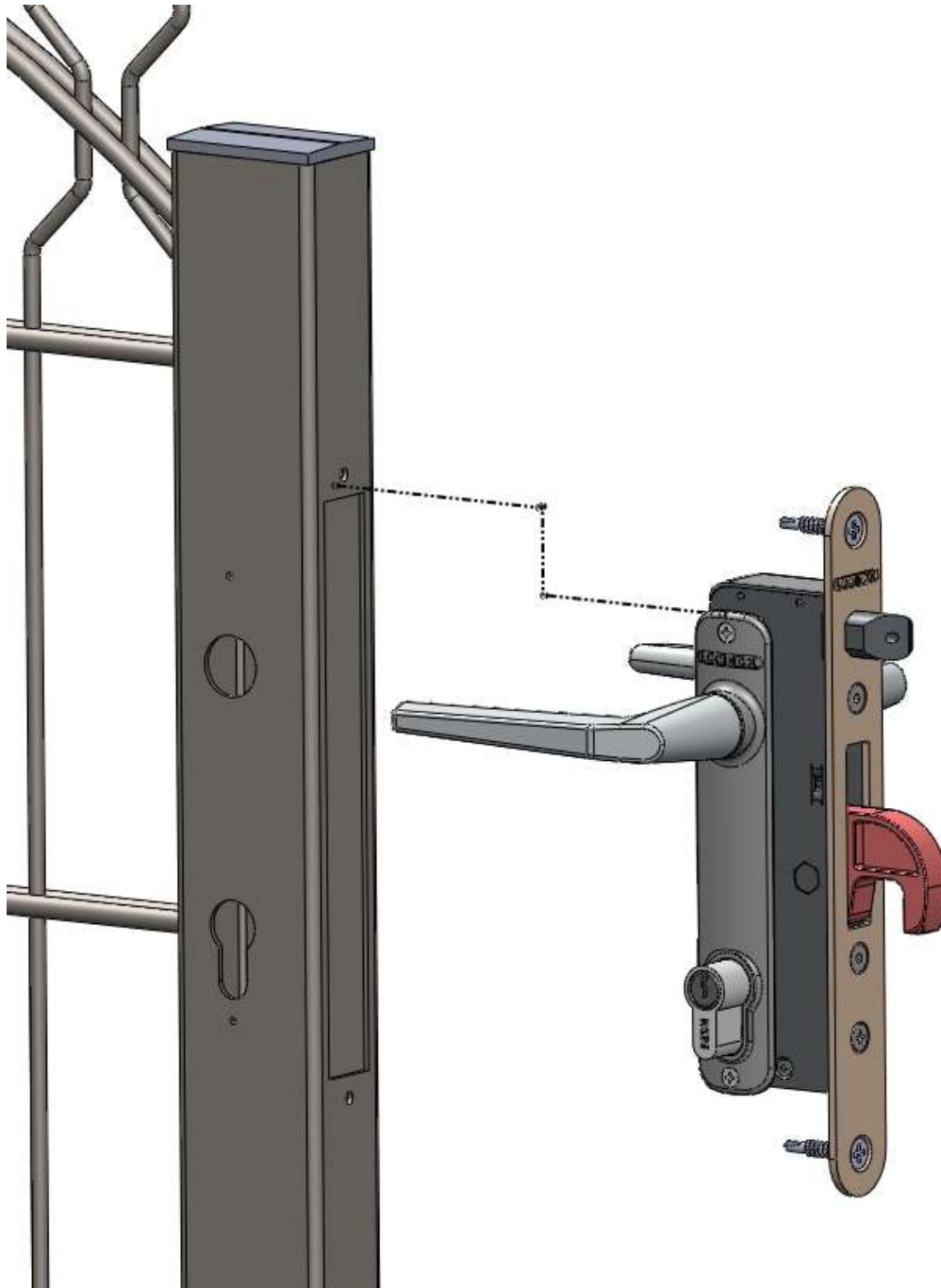

Dubbele draaipoorten  
Portails doubles  
Double swing gates  
Zweiflügeliges Tor  
Cancelli ad ante doppie  
Puertas dobles giratorias

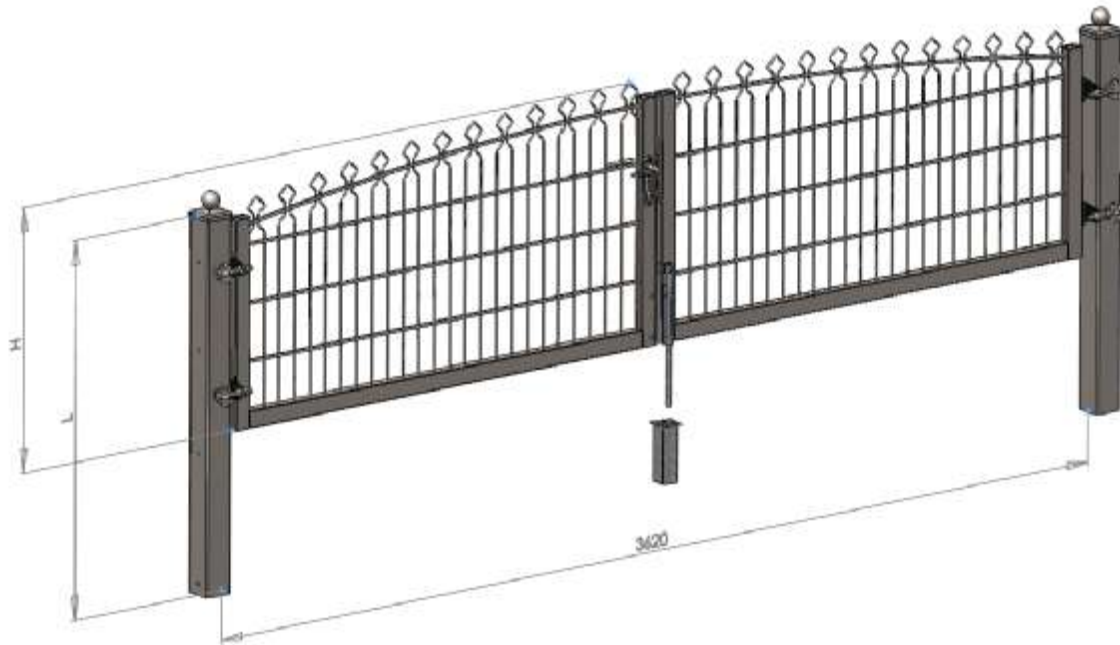

H (mm)	L (mm)
1086	1800
1286	2000
1486	2250
1886	2750



Dubbele poort + panelen + palen in beton  
 Portail double + panneaux + poteaux à sceller  
 Double gates + panels + posts in concrete  
 Zweiflügeliges Tor + Matten + Pfosten zum Einbetonieren  
 Cannello ad ante doppie + pannelli + pali in calcestruzzo  
 Puertas dobles + paneles + postes en el hormigón

## Decofor Arco

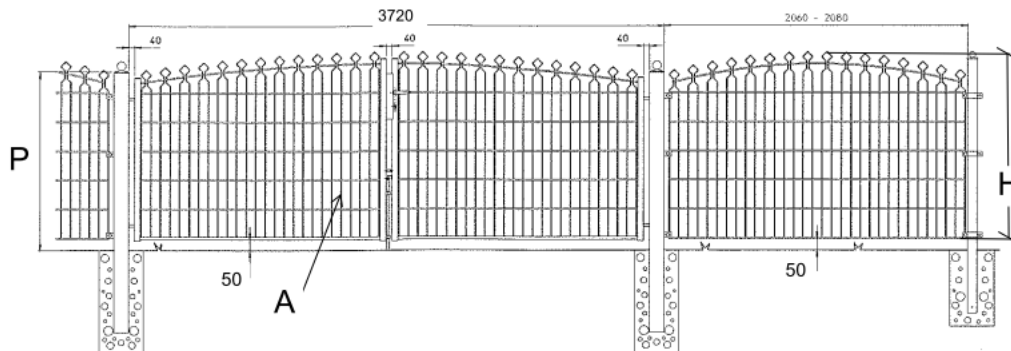

## Decofor Recto

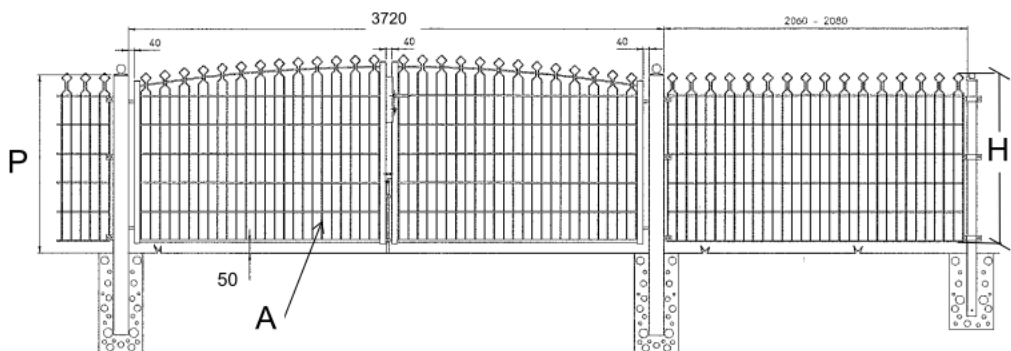

H (mm)	A (mm)	P (mm)
1086	1086	1043
1286	1286	1243
1486	1486	1443

Dubbele poort + panelen + palen met alu-voet  
Portail double + panneaux + poteaux avec platine alu  
Double gates + panels + posts with alu-floorplate  
Zweiflügeliges Tor + Matten + Pfosten mit Alu-Bodenplatte  
Cancello ad ante doppie + pannelli + pali con piastra di base in alluminio  
Puertas dobles + paneles + postes con place en aluminio

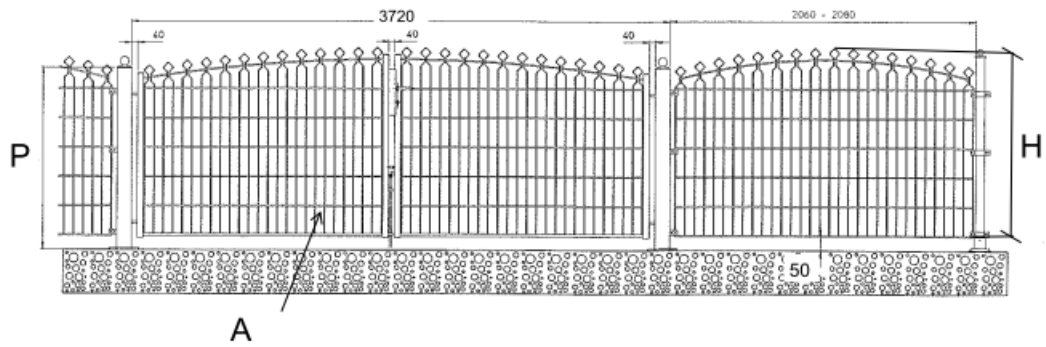

Dubbele poort + panelen op muur + palen met alu-voet  
 Portail double + panneaux sur mur + poteaux avec platine alu  
 Double gates + panels on wall + posts with alu-floorplate  
 Zweiflügeliges Tor + Matten auf Mauer + Pfosten mit Alu-Bodenplatte  
 Cannello ad ante doppie + pannelli su muro + pali con piastra di base in alluminio  
 Puertas dobles + paneles sobre muro + postes con place en aluminio

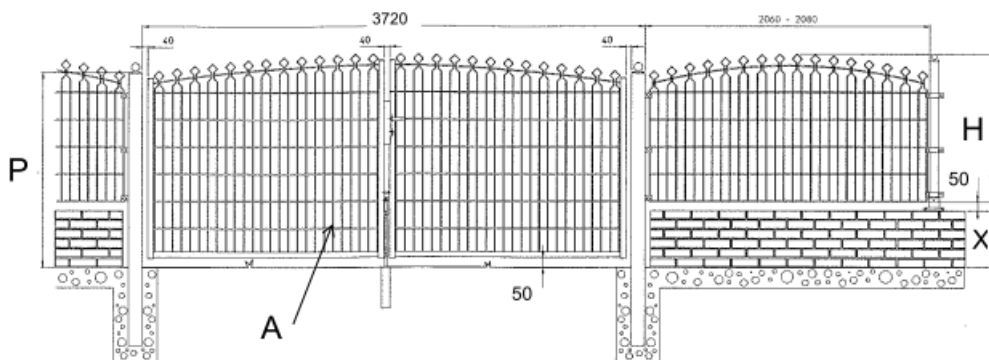

<b>H (mm)</b>	<b>X (mm)</b>	<b>A (mm)</b>	<b>P (mm)</b>
886	400	1286	1243
886	600	1486	1443
886	1000	1886	1843
1086	400	1486	1443
1086	800	1886	1843
1286	600	1886	1843
1486	400	1886	1843

Dubbele poort + panelen tussen muurkolommen  
 Portail double + panneaux entre pilastres  
 Double gates + panels between pilasters  
 Zweiflügeliges Tor + Matten zwischen Wandpfeilern  
 Cancelli ad ante doppie + pannelli fra colonne  
 Puertas dobles + paneles entre pilastras

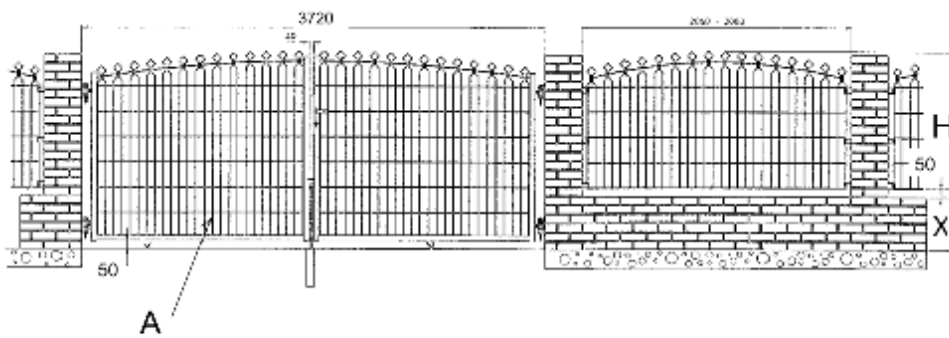

H (mm)	X (mm)	A (mm)
886	400	1286
886	600	1486
886	1000	1886
1086	400	1486
1086	800	1886
1286	600	1886
1486	400	1886

Montage Scharnieren dubbele poort  
Montage charnières pour portail double  
Hinge assembly double gate  
Montage der Scharniere für ein zweiflügeliges Tor  
Montaggio cerniere al cancello ad ante doppie  
Montaje bisagras puerta doble

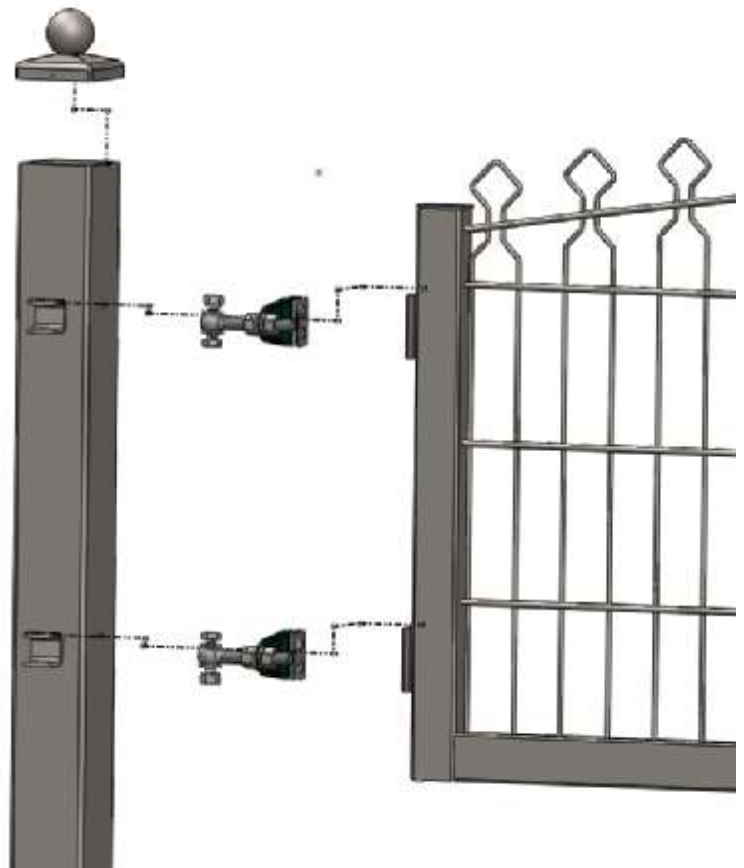

Montage muurscharnier dubbele poort  
Montage charnière pour portail double pour mur  
Wall hinge assembly double gate  
Montage der Scharniere für Mauerbefestigung  
Montaggio cerniera murale al cancello ad ante doppie  
Montaje bisagra mural puerta doble

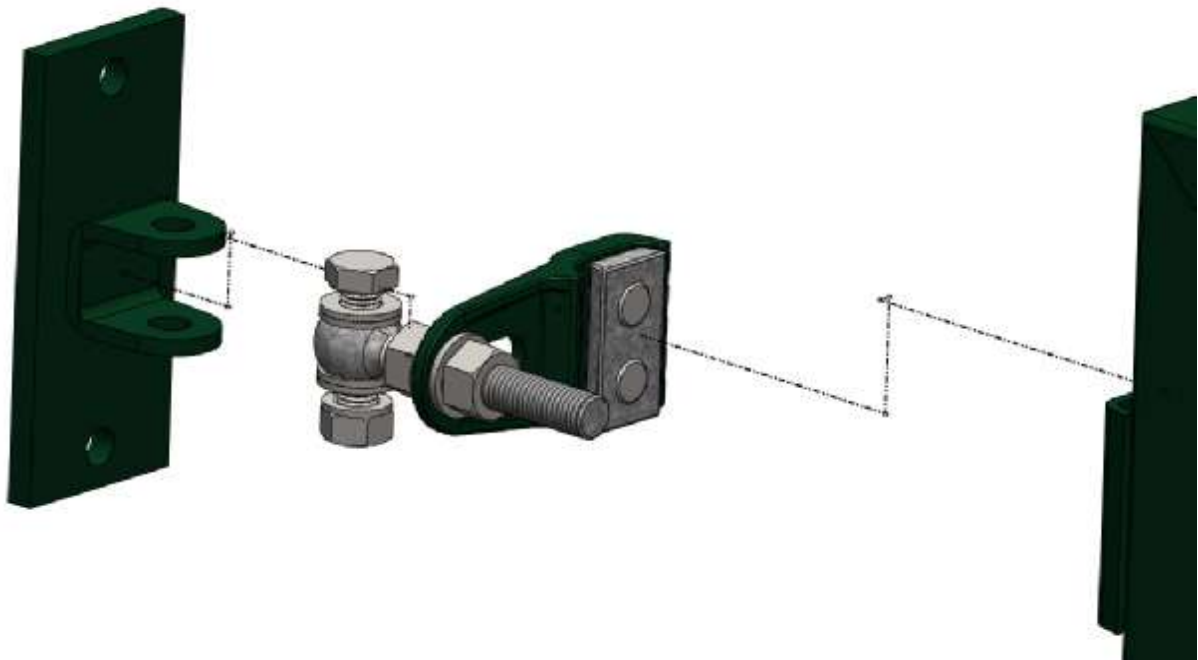

Montage slot dubbele poort  
Montage serrure pour portail double  
Lock assembly double gate  
Montage des Schlosses für ein zweiflügeliges Tor  
Montaggio serratura al cancello ad ante doppie  
Montaje cerradura puerta doble

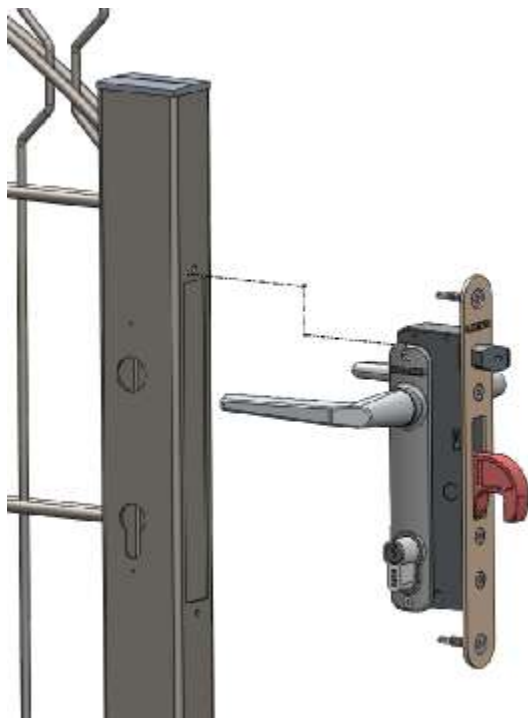
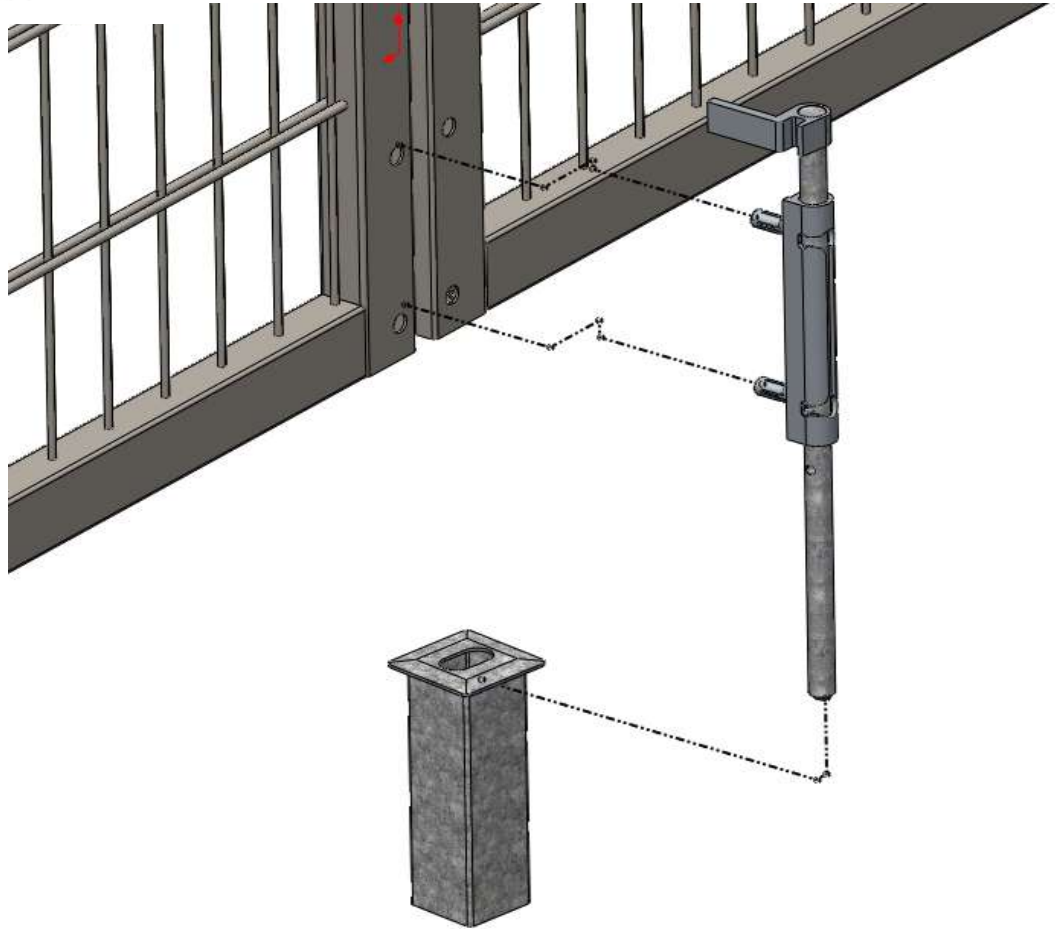



NOTE:

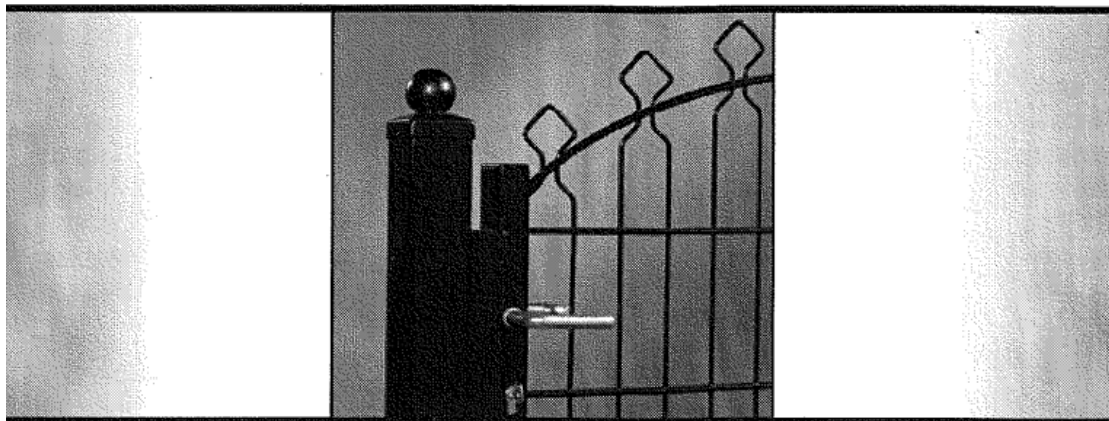

*Filial manufacturer*  
**Betafence España, S.L**  
Sociedad Unipersonal  
C/ López Bravo, 94  
Apartado de correos 347  
E-09001 Burgos  
Tel.: +34 947 298 073  
Fax: +34 947 298 670  
info.spain@betafence.com

**Betafence France SA**  
2, rue Alexis de Tocqueville  
Parc de Haute technologie  
F-92183 Antony Cedex  
Tel.: +33 (0)1 40 96 26 22  
Fax: +33 (0)1 40 96 26 06  
info.france@betafence.com

**Betafence NV**  
Sales Benelux  
Deerlijkstraat 58A  
B-8550 Zwevegem  
Tel.: +32 56 73 46 46  
Fax: +32 56 73 45 45  
Tel.: NL. 0800 022 76 98  
Fax: NL. 0800 022 77 45  
info.benelux@betafence.com

**Betafence Italia Spa**  
C. da Salinello, 59  
I-64018 Tortoreto (TE)  
Tel.: +39 0861 7801  
Fax: +39 0861 780650  
info.italy@betafence.com

**Betafence Portugal Lda**  
Av. Almirante Gago Coutinho  
Nº 56 - 2º Esq. Frente  
P-1700-031 Lisboa  
Tel.: +351 21 847 0040  
Fax: +351 21 847 0045  
info.portugal@betafence.com

**Werler Drahtwerke GmbH**  
**Betafence**  
Runtestrasse 5-9 & 24  
D-59457 Werl  
Tel.: +49 2922 9890  
Fax: +49 2922 989 153  
info.germany@betafence.com

**Betafence Ltd**  
PO Box 119, Shepcote Lane  
UK-Sheffield S9 1TY  
Tel.: +44(0) 870 1270 027  
Fax: +44(0) 870 1270 028  
info.uk@betafence.com

**Betafence Sweden**  
Gräsvägen 8B  
S-448 36 Floda  
Tel.: +46 (0) 302 356 25  
Mobile: +46 (0) 708 26 17 71  
Fax: +46 (0) 302 356 25  
Email: info.nordic@betafence.com