

Installation for Universal Cage with B17 Adapter Bar

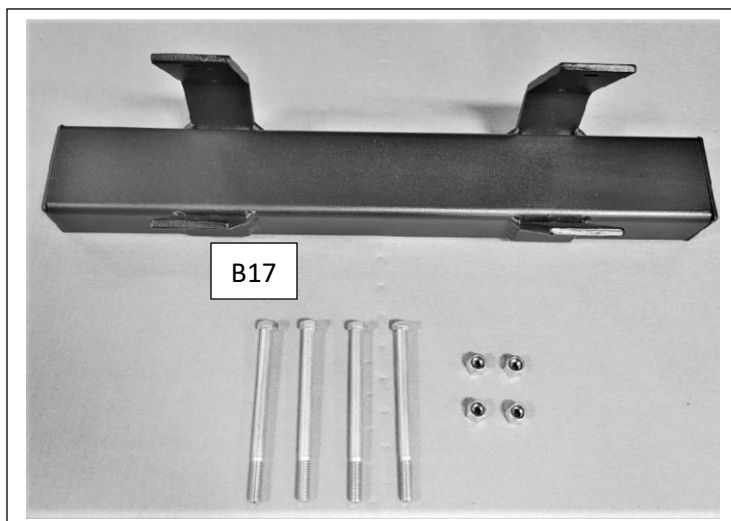

Universal Cage Toro B17 Hardware

- | | |
|--------------------------|----------------------|
| 1- Universal Fan Cage | 1- Crossbar |
| 2- Rubber bushings | 1- B17 Adapter Bar |
| 2- 3"x 5" Square U Bolts | 4- 3/8"-16x 5" Bolts |
| 2- 3" Steel Straps | 8- 3/8-16 Lock Nuts |



B17

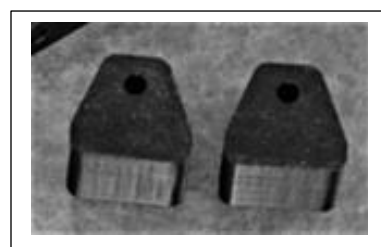
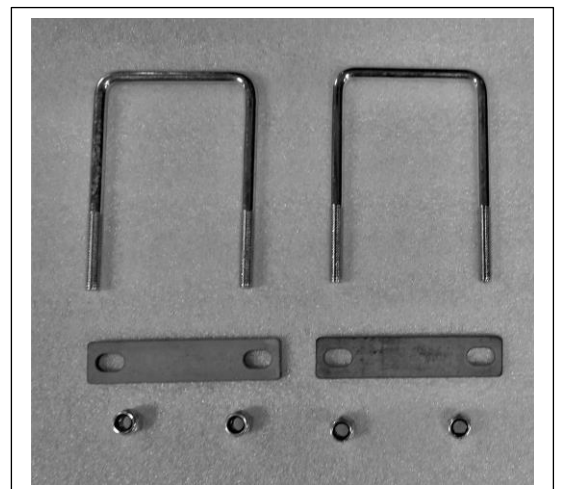

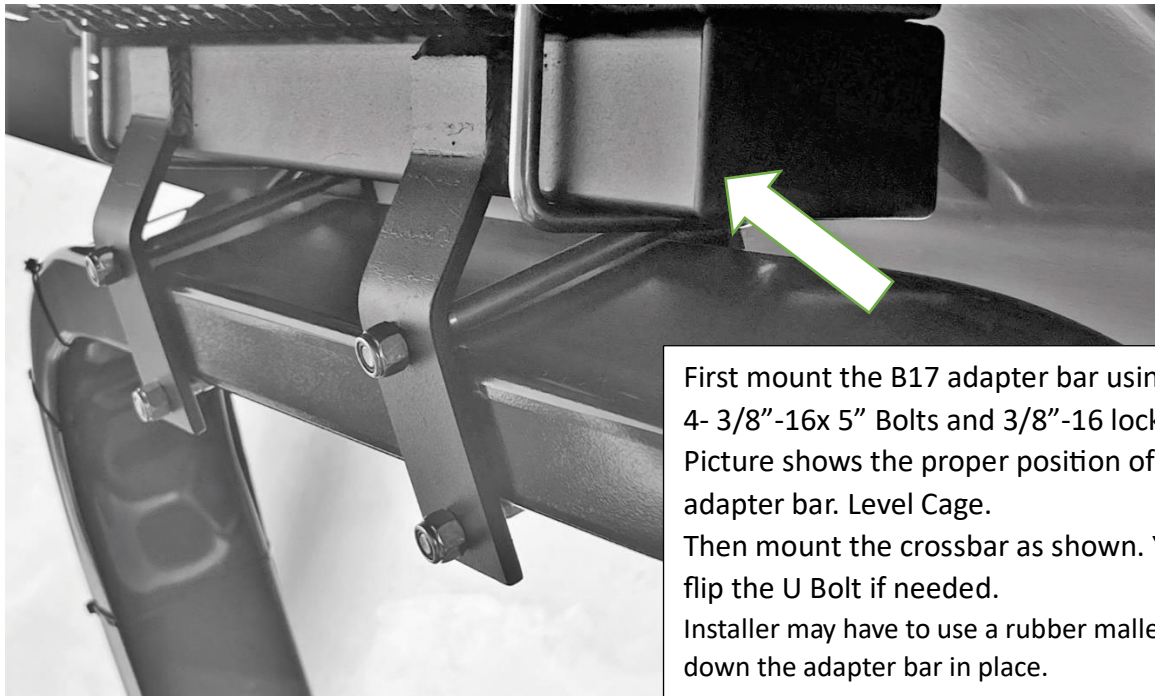
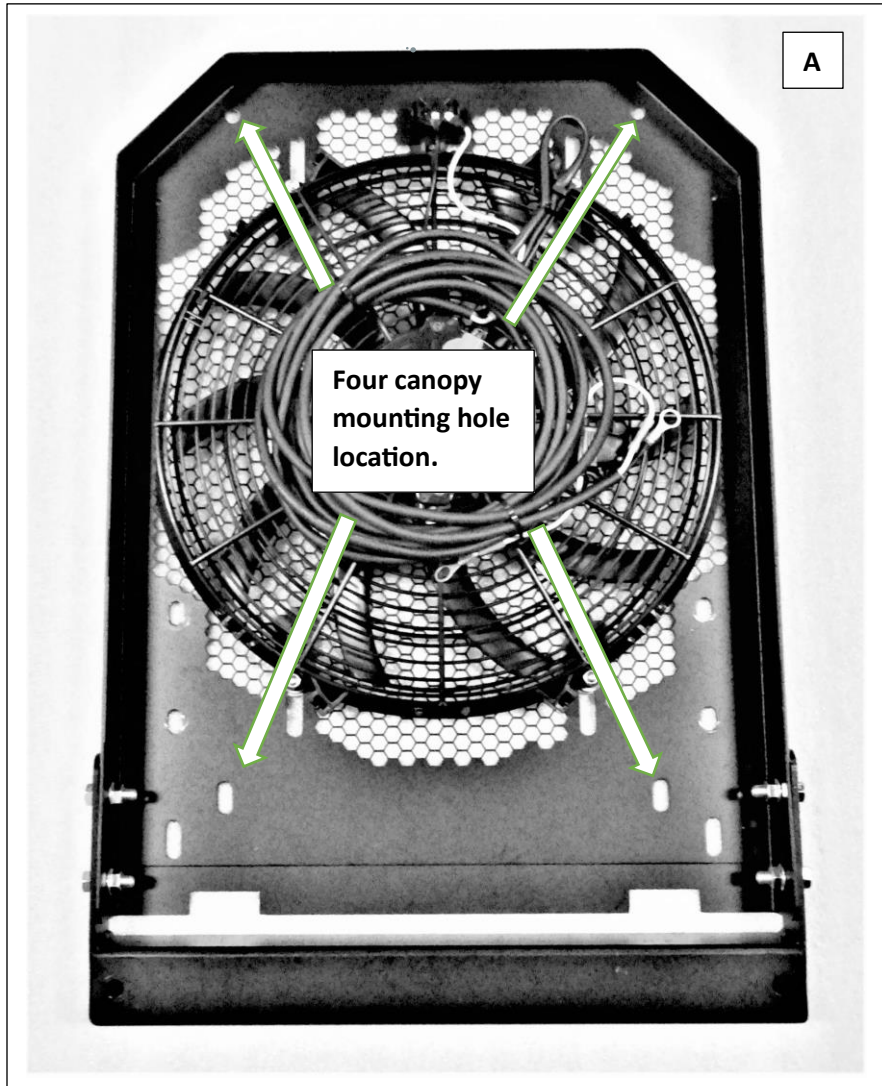

Mounting the Crossbar

Measure 3" from inside edge of crossbar for U Bolt location. Place the rubber bushing as pictured to the rear of the crossbar.

Mount the crossbar to the B17 adapter bar using the 2- 3"x 5" U Bolts and 2- 3" straps. Tighten U Bolts evenly, be careful not to misalign either side of U Bolt, Power tools usually over tighten or misalign the steel strap plate.

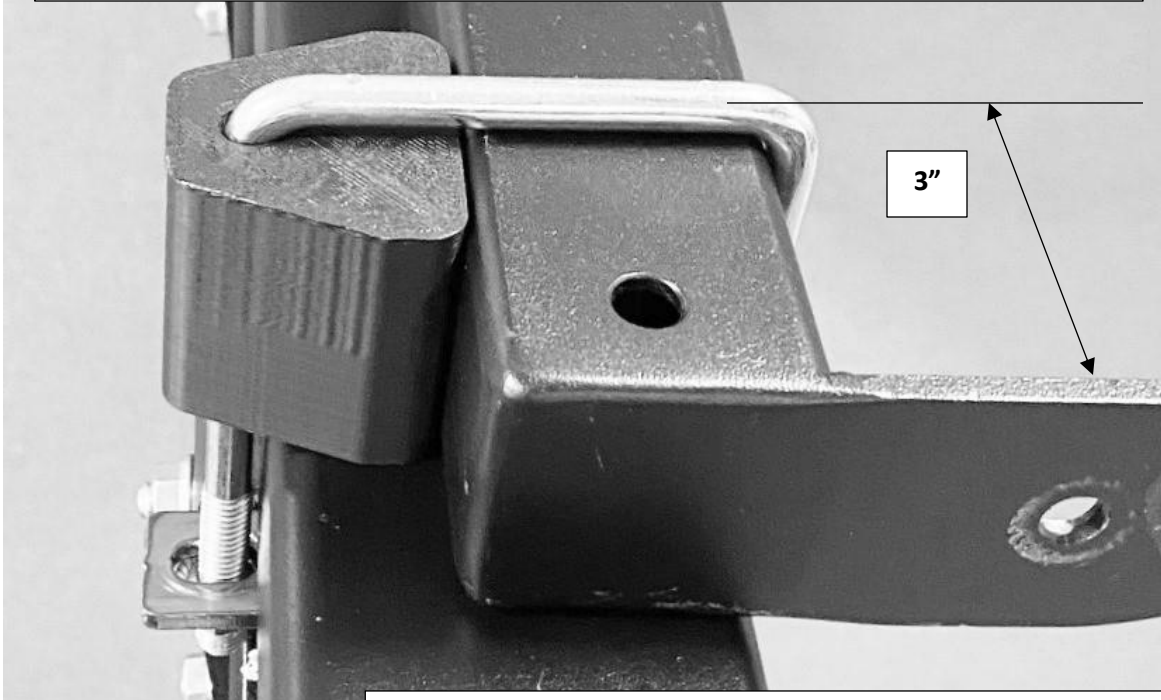

Picture shows cage mounted at level position.

The Crossbar is designed with multiple locations to adjust to forward or rear leaning rollover bars.

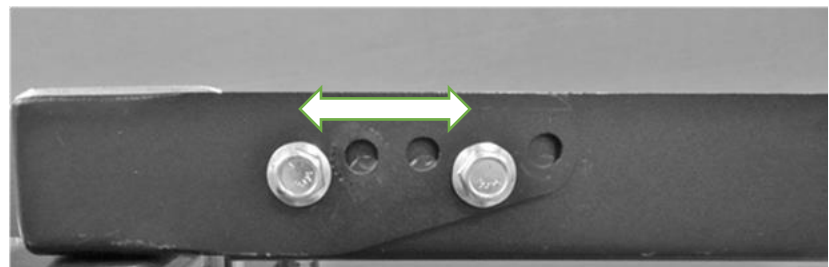

For Toro Groundmaster and Reelmaster not needing the adapter bar. This will be your level position on forward leaning rollover bar. Hold the cage as you tighten to lock in level position.

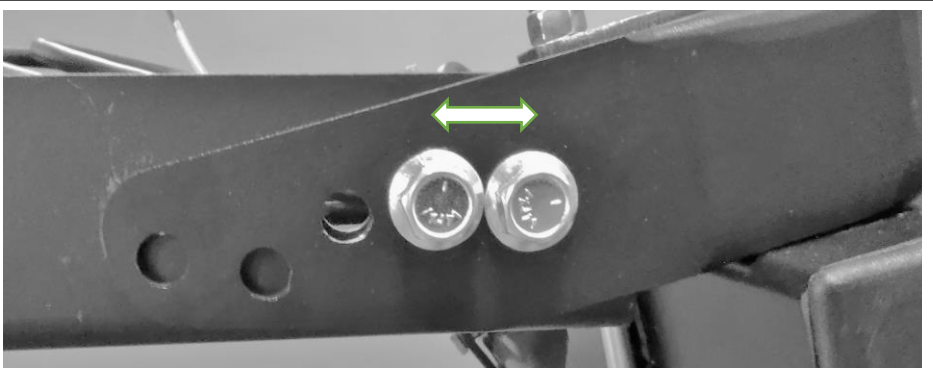

Cage Mounting Hardware

4- 3/8" lock nuts

4- 3/8" split lock washers

4- 3/8"-16 x 1" Shoulder Bolts



Connecting the Electrical Cord



Fan Cage comes prewired ready to hook to the battery.

1. Snip the cable ties holding the cord. Feed the cord between the cage and the crossbar.
2. Using the cable ties strap the electrical cord to the upper part of the rollover bar then follow it down to the equipment frame or along the electrical harness till you reach the Battery.
3. The white wire with the fuse box will hook to the positive terminal, and the other wire to the negative terminal.

Option: Two butt connectors have been provided if installer wishes to shorten the cable.

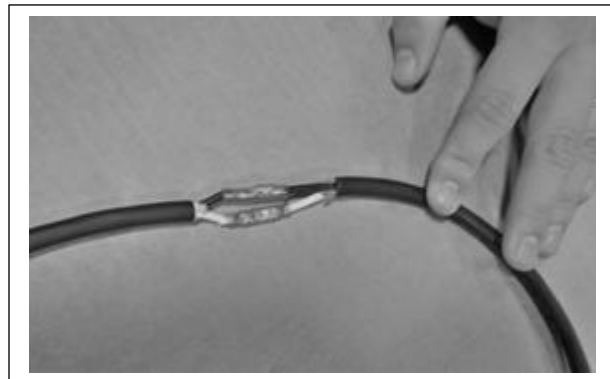
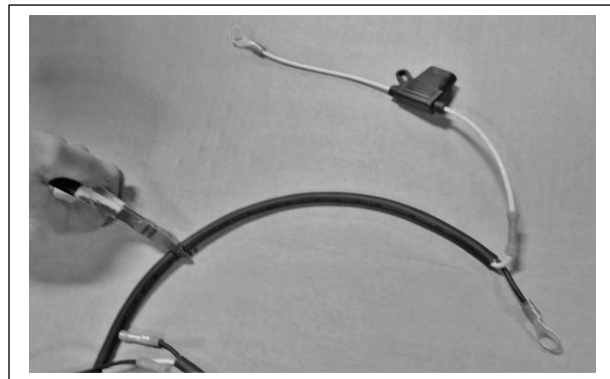

Mounting Canopy and Rain Cover (The front of the canopy has yellow reflectors.)

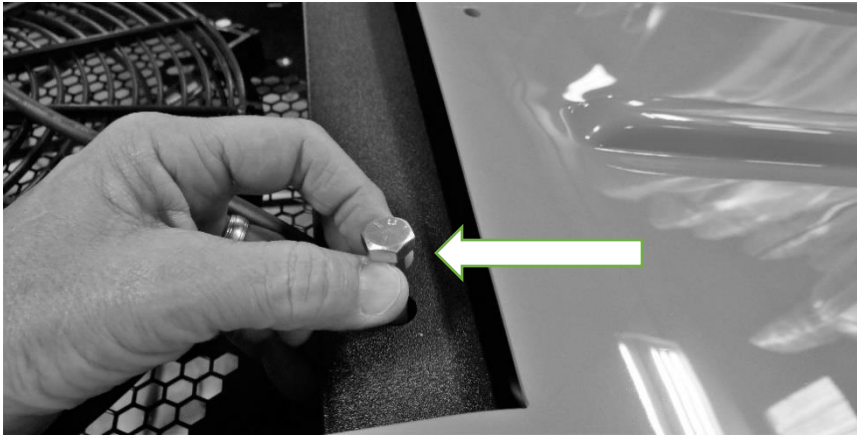

4- 3/8" – 16 x 3" Bolts
4- 3/8" Washers, and
4- 3/8"-16 Locknuts
6- 1/4-20 x 3/4" Bolts
6- Seal Washers
6- 1/4-20 Locknuts

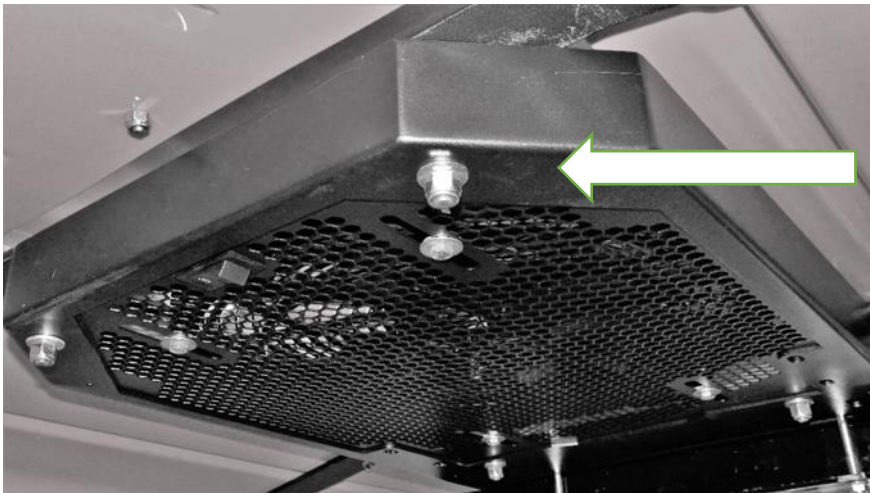

Reference picture **A** on first page for canopy hole location.

Using 4- 3/8" – 16 x 3" Cap Screws, 4- 3/8" Flat Washers, and 4- 3/8"-16 Locknuts, mount canopy through the predrilled canopy bars through into cage screen holes as seen in picture.

Before tightening make sure the bolts are straight and vertical.

Install Rain Cover:

Using the 6- 1/4-20 x 3/4" Cap Screws, 6- Seal Washers, and 6- 1/4-20 Locknuts mount the canopy rain cover.

Sealed washers go on topside and of the canopy.

Mount taller end of rain cover to the rear so it will slant forward.

Use hand tools to install rain cover.

