

**SPECIFICATION**

**SS-120C Series LED Driver**

**Model: SS-120C-XX**

**Description: 120W LED DRIVER**

**Rev.: V04**

**Release Date: 2018-04-08**



**SHENZHEN SOSEN ELECTRONICS CO.,LTD**

A3 Building, Gonghe Fourth Industrial Area, Shajing Street, Baoan District  
Shenzhen, China 518104



### Features

- Efficiency up to 91%
- Optional dimming function: 0-10V, PWM, Resistor, Timing
- IP65 rated; Suitable for Dry, Damp and Wet Locations
- Protections: SCP, OTP, OVP
- Metal case with full potted for hazardous scenarios
- Surge Protection: L/N-PE: 4kV, L-N 4kV
- 5 years warranty



### Description

SS-120C series are constant current LED driver with input voltage 90-305Vac and high power factor. They are specifically designed for LED high bay luminaries, with low standby power, high efficiency, compact housing and good thermal management, which greatly enhance the reliability and lifespan. Comprehensive protections, including Over Voltage Protection, Short Circuit Protection and Over Temperature Protection, ensure proper functioning.

### Model List

| Model       | O/P Voltage | O/P Current | Max. O/P Power | O/P Current Tolerance | THD (Typ.) | PF (Typ.) | Efficiency (Typ.) |
|-------------|-------------|-------------|----------------|-----------------------|------------|-----------|-------------------|
| SS-120C-40* | 24-40V      | 2.0-3.75A   | 120W           | ± 5%                  | 7%         | 0.98      | 90%               |
| SS-120C-54* | 27-54V      | 1.5-2.85A   | 120W           | ± 5%                  | 7%         | 0.98      | 91%               |
| SS-120C-68* | 40-68V      | 1.2-2.15A   | 120W           | ± 5%                  | 7%         | 0.98      | 91%               |

#### Note:

1. Default Tested at 230Vac, full load, Ta 25°C.
  2. Optional B, T or space in the place of \* means additional function.  
Space is the base model without any optional function;
- Suffix B for model with 3-in-1 dimming (0-10V, PWM, Resistor);
  - Suffix T for model with timing control.



### Input Characteristics

| Parameter             | Min     | Typ. | Max     | Remarks   |
|-----------------------|---------|------|---------|---|
| Rated AC input range  | 100 Vac |      | 277 Vac |   |
| AC input range        | 90 Vac  |      | 305 Vac |   |
| Input frequency range | 47Hz    |      | 63Hz    |   |
| Max input current     |         |      | 1.6A    | 90Vac, full load  |
| Inrush current        |         |      | 60A     | Cold start, 347Vac/50Hz ,<br>Twidth=650us measured at 50% Ipeak |
| No load power         |         | 1W   | 2W      | 277Vac/50Hz, no load  |
| Power factor          | 0.95    | 0.98 |         | 230Vac/50Hz, full load  |
|                       | 0.9     |      |         | 100-277Vac/50Hz, 70-100% Load                                   |
| THD                   |         | 7%   | 10%     | 230Vac/50Hz, full load  |
|                       |         |      | 20%     | 100-277Vac/50Hz, 70-100% Load                                   |

### Output Characteristics

| Parameter                     | Min         | Typ.  | Max   | Remarks                              |
|-------------------------------|-------------|-------|-------|--------------------------------------|
| Output voltage range          | SS-120C-40* | 24V   | 40V   | Power derated @ 24-32Vdc, see Fig. 1 |
|                               | SS-120C-54* | 27V   | 54V   | Power derated @ 27-42Vdc, see Fig. 1 |
|                               | SS-120C-68* | 40V   | 68V   | Power derated @ 40-56Vdc, see Fig. 1 |
| Rated output voltage          | SS-120C-40* | 32V   | 40V   | Po=Vo*Io=120W, full load, see Fig. 1 |
|                               | SS-120C-54* | 42V   | 54V   |                                      |
|                               | SS-120C-68* | 56V   | 68V   |                                      |
| Rated output current          | SS-120C-40* | 3.00A | 3.75A | 3.0A for 40V, 3.75A for 32V          |
|                               | SS-120C-54* | 2.25A | 2.85A | 2.25A for 54V, 2.85A for 42V         |
|                               | SS-120C-68* | 1.75A | 2.15A | 1.75A for 68V, 2.15A for 56V         |
| Current adjustable range      | SS-120C-40* | 2.00A | 3.75A | Rated Io 70%-100% adjustable         |
|                               | SS-120C-54* | 1.50A | 2.85A |                                      |
|                               | SS-120C-68* | 1.20A | 2.15A |                                      |
| No load voltage               | SS-120C-40* | 40.5V | 41.5V | 42V                                  |
|                               | SS-120C-54* | 54.5V | 55.5V | 56V                                  |
|                               | SS-120C-68* | 68.5V | 69.5V | 70V                                  |
| Efficiency @230Vac            | SS-120C-40* | 88%   | 90%   | Output 40V/3A, see Fig. 5            |
|                               | SS-120C-54* | 89%   | 91%   | Output 54V/2.25A, see Fig. 5         |
|                               | SS-120C-68* | 89%   | 91%   | Output 68V/1.75A, see Fig. 5         |
| Output current tolerance      | -5%         |       | +5%   |                                      |
| Output voltage ripple (PK-PK) |             | 1%    | 2%    | Full load                            |



|                               |     |    |     |           |
|-------------------------------|-----|----|-----|-----------|
| Output current ripple (PK-PK) |     | 5% | 10% | Full load |
| Start-up current overshoot    |     |    | 10% |           |
| Start-up time                 |     | 1S | 2S  | 230Vac    |
| Line Regulation               | -1% |    | +1% | Full load |
| Load Regulation               | -2% |    | +2% |           |

### Other Characteristics

| Parameter                      |                             | Min  | Typ. | Max   | Remarks  |
|--------------------------------|-----------------------------|--|------|---|--|
| 0-10V Dimming<br>(Optional)    | Dim Vmax                    | 0V   |      | 14V   | 3 in 1 Dimming;<br>0-5V Dimming Optional;<br>Negative Logic Dim Optional |
|                                | Dim Range                   | 10%Iomax   |      | 100%Ioset                                       |  |
|                                | Voltage                     | 1V   |      | 10V   |  |
|                                | OFF                         | 0.3V   | 0.5V | 0.7V  | Dim-off value  |
|                                | ON                          | 0.5V   | 0.7V | 0.9V  |  |
| PWM Dimming<br>(Optional)      | High                        | 5V   |      | 10V   |  |
|                                | Low                         | -0.3V  |      | -0.6V   |  |
|                                | Frequency                   | 200Hz  |      | 2KHz  |  |
|                                | PWM Duty                    | 1%   |      | 99%   |  |
| Resistor Dimming<br>(Optional) | Resistance                  | 10K ohm  |      | 100K ohm  |  |
|                                | Dimming                     | 10%Iomax   |      | 100%Ioset                                       |  |
| Timing Curve<br>(Optional)     | IC Control                  | By programming   |      |   | Typically 3-4 sections   |
|                                | Timing                      | 5H/6H/7H/8H per section                                  |      |   | Default Mode: 24Hour/Circle with<br>50% load                             |
| Protection                     | OTP                         | 80°C   | 85°C | 90°C  | Shut down o/p voltage, re-power<br>on to recovery                        |
|                                | Short Circuit<br>Protection | Driver will not damaged with<br>short-circuit power <10W |      |   | Hiccup mode  |
| Life time                      |                             | 55,000hrs  |      | 230Vac, full load, Tc 75°C,<br>See Fig. 6       |  |
| MTBF                           |                             | 200,000hrs   |      | 230Vac, full load, Ta= 25°C,<br>(MIL-HDBK-217F) |  |
| Temperature Coefficient        | -0.03%/°C                   |  |      | +0.03%/°C                                       | Tc: 0°C ~90°C  |
| Tc                             |                             |  |      | 85°C  |  |
| Warranty                       |                             | 5 years  |      |   | Tc: 75°C   |
| Net Weight                     |                             | 1200g  |      |   |  |
| Dimension                      | Φ132mm*71mm                 |  |      |   | D x H  |

**NOTE:** All the parameters above are tested Ta 25°C, unless specified.



### Environmental Requirements

| Parameter             | Min         | Typ. | Max    | Remarks    |
|-----------------------|-------------|------|--------|------------|
| Operating Temperature | -40°C       | 25°C | +60°C  | See Fig. 2 |
| Storage Temperature   | -40°C       | 25°C | +85°C  |            |
| Operation Humidity    | 10%RH       |      | 90%RH  |            |
| Storage Humidity      | 5%RH        |      | 95%RH  |            |
| Altitude              | -65m        |      | 4,000m |            |
| Cooling Method        | Air Cooling |      |        |            |

### Safety and EMI/EMS Standards

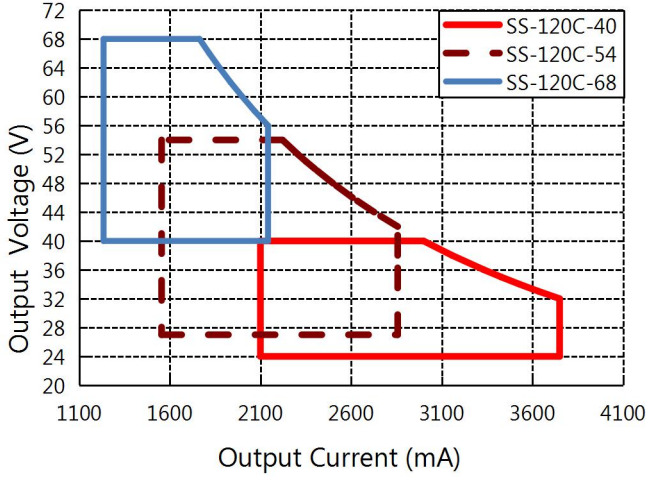
| Certification | Standard   | Status | Remark             |
|---------------|--|--------|--------------------|
| UL/CUL        | UL8750   | ✓      |                    |
| TUV           | EN 61347-2-13:2014<br>EN61347-1:2008+A1:2011+A2:2013<br>EN62493:2015 | ✓      |                    |
| SAA           | AS/NZS61347.2.13   | ✓      |                    |
| CCC           | GB 19510.14-2009   | ✓      |                    |
| BIS           | IS15885:2012 Part 2 Sec 13   | ✓      | ONLY for -B models |
| CE            | EN 61347-2-13:2014<br>EN61347-1:2008+A1:2011+A2:2013                 | ✓      |                    |

| Item                       | Standard             | Remark  |
|----------------------------|----------------------|---|
| Insulation strength        | Input-output         | 3200Vac/5mA Max/60s                                 |
|                            | Primary-Earth        | 1600Vac/5mA Max/60s                                 |
|                            | Sec.- Earth          | 1000Vac/5mA Max/60s                                 |
| Insulation resistance      | Input-output         | ≥10MΩ   |
|                            | Ground resistor      | ≤0.1Ω   |
| Leakage current            | ≤0.75mA              | 277Vac  |
| Item                       | Criterion            | Remark  |
| Conduction Emission        | EN55015:2013+A1:2015 |   |
| Radiation Emission         | EN55015:2013+A1:2015 |   |
| Harmonic Current Emissions | IEC/EN 61000-3-2     | Class C   |
| Surge                      | IEC/EN61000-4-5      | Difference mode 4kV,<br>Common mode 4kV Criterion B |

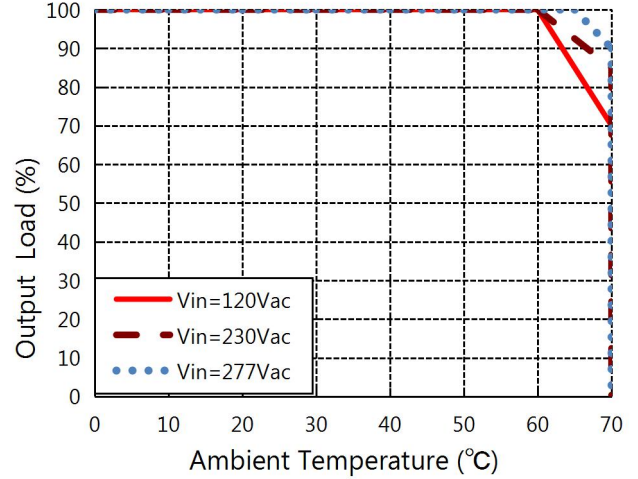
**NOTE:** SOSEN warrants the LED Driver itself complies with EMC standard. However, LED Driver's EMC should be re-checked when integrated into lighting systems due to unexpected interference as component.

## Performance Curves

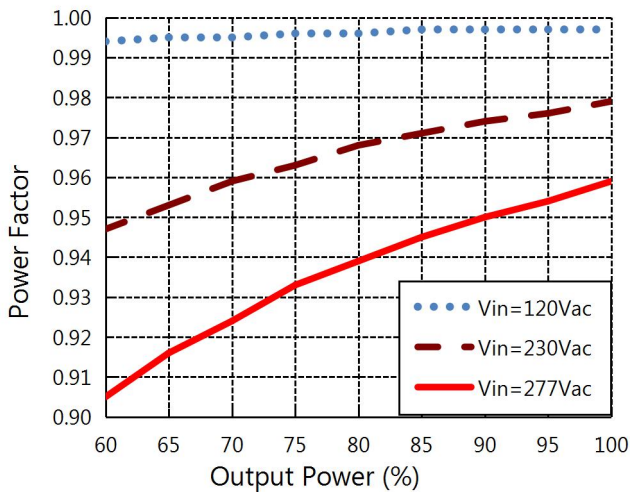
**Fig. 1 O/P Voltage VS Output Current**



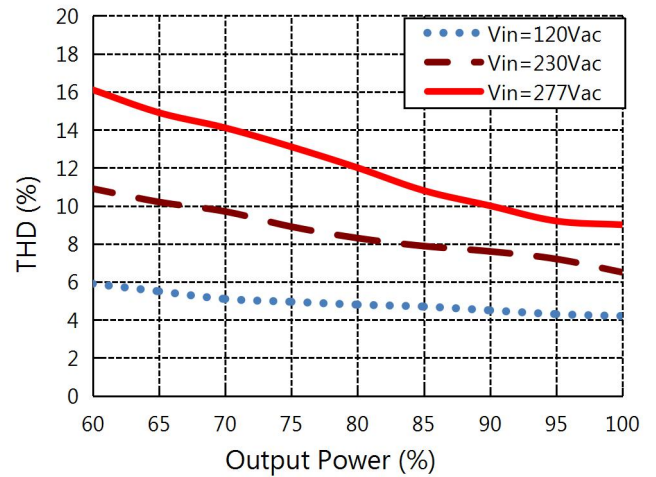
**Fig. 2 O/P Power VS Ambient Temperature**



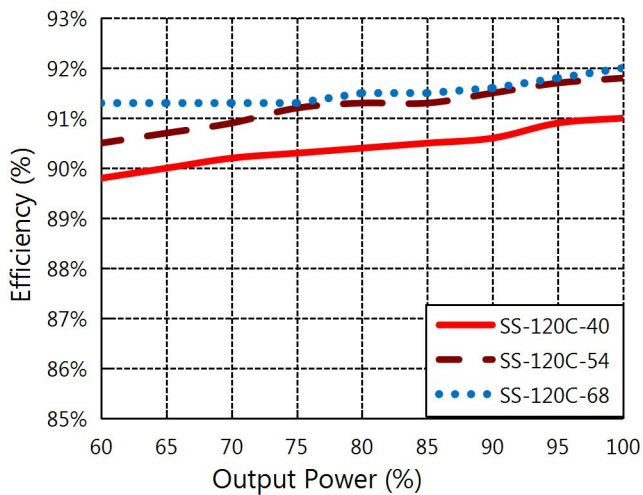
**Fig. 3 Power Factor VS Output Power**



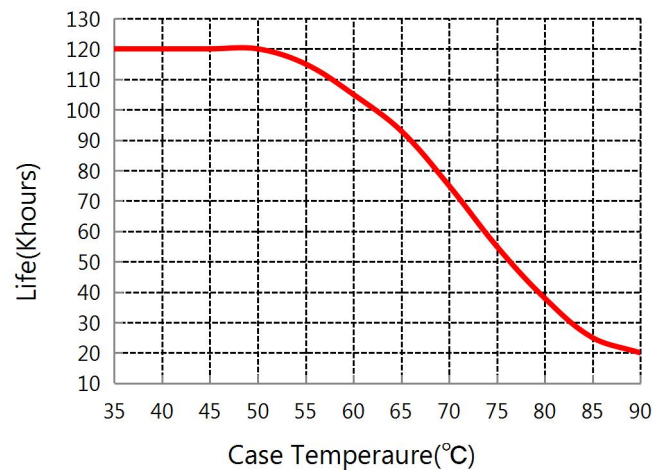
**Fig. 4 THD VS Output Power**



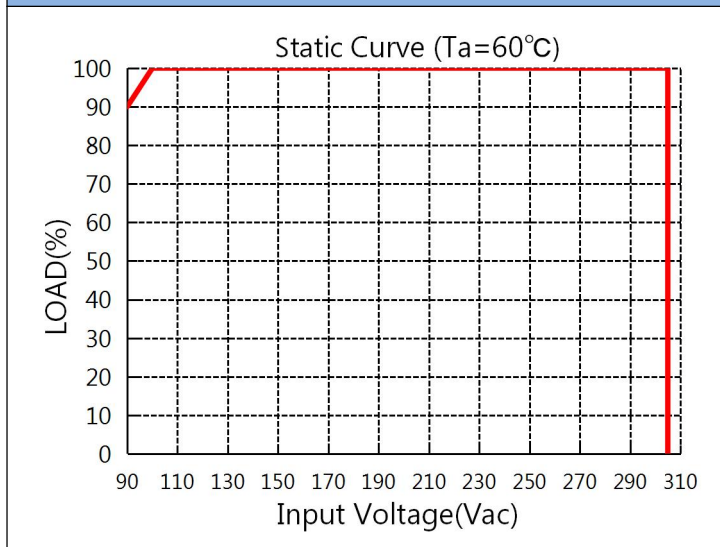
**Fig. 5 Efficiency VS Output Power**



**Fig. 6 Lifespan VS Case Temperature**

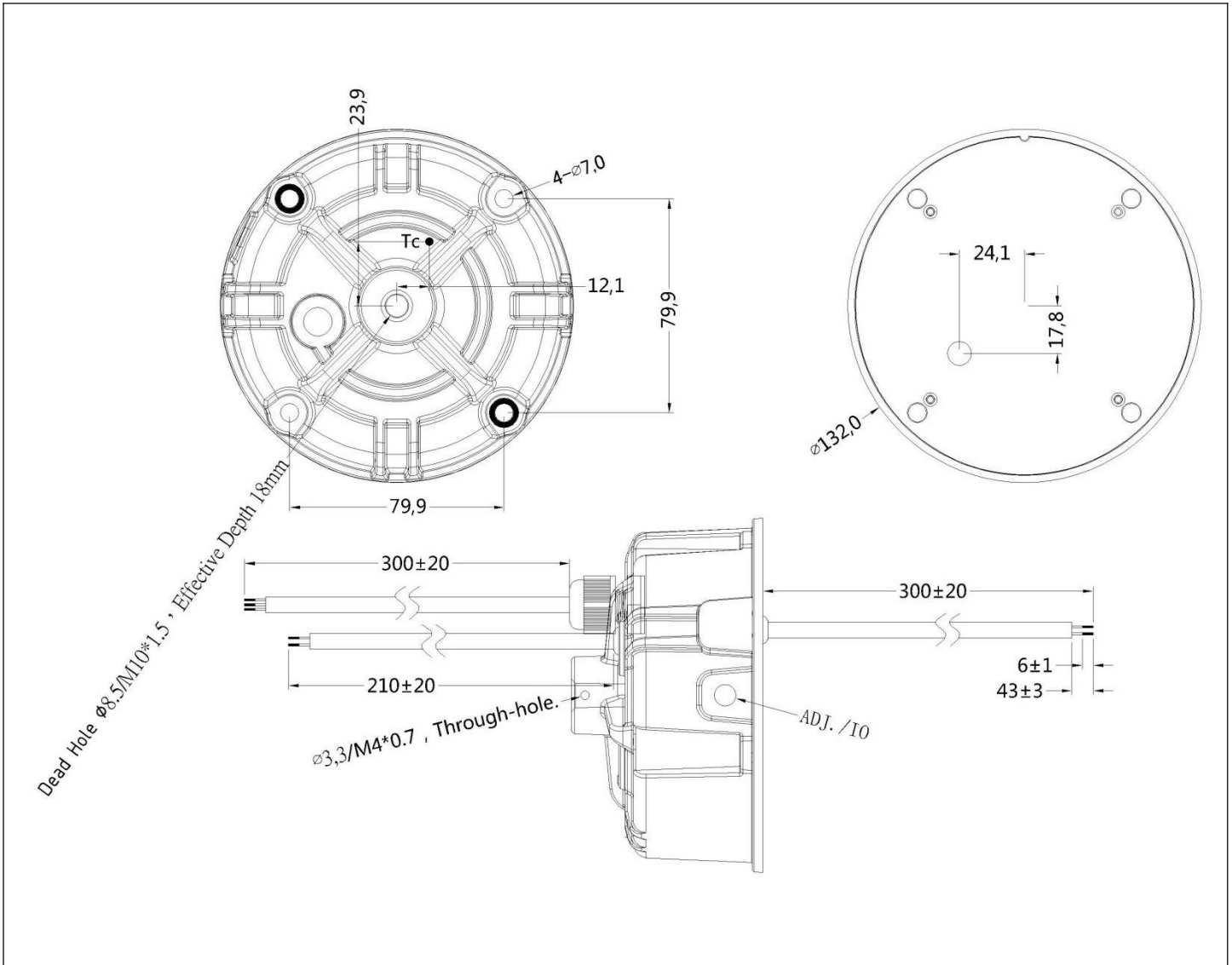


**Fig. 7 Output Power VS Input Voltage**





### Mechanical Characteristics (Unit: mm)



#### NOTE:

|                 |   |
|-----------------|---|
| Input Wire      | UL model: UL SJTW #18AWG 3*0.824 mm <sup>2</sup> , O.D: 7.8mm, GREEN: PE, BLACK: L, WHITE: N<br>Euro model: VDE H05RN-F 3*1.0 mm <sup>2</sup> , O.D: 7.4mm, BROWN: L, BLUE: N, YELLOW/GREEN: PE |
| Output Wire     | UL model: UL SJTW #14AWG 2*0.824mm <sup>2</sup> , O.D: 7.6mm, RED: V+, BLACK: V-<br>Euro model: VDE H05RN-F 2*1.0 mm <sup>2</sup> , O.D: 7.0mm, BROWN: V+, BLUE: V-                             |
| Suffix B<br>DIM | STYLE 2733 #22AWG O.D: 5.8mm, PURPLE: DIM+, GRAY: DIM-  |

### Labels

| UL   |  |
|--|--|
| <p style="text-align: center;"> <b>MODEL:SS-120C-40B</b></p> <p style="text-align: center;"><b>SOSEN</b> Constant Current LED Driver</p> <p>○ ACL--BLACK<br/>○ ACN--WHITE<br/>○ --GREEN<br/>MADE IN CHINA<br/><a href="http://www.szsofen.com">HTTP://www.szsofen.com</a></p>  | <p style="text-align: center;"><b>Manufacturer: Shenzhen Sosen Electronics Co.,Ltd</b></p> <p><b>INPUT: 100-277V~ 1.5A 50/60Hz</b> <span style="float: right;"><math>t_c: 85^\circ\text{C}</math><br/><math>t_a: 60^\circ\text{C}</math></span></p> <p><b>OUTPUT: 24-40V<math>\equiv</math> 2.0-3.75A Max.42V Max.120W</b></p> <p style="text-align: center;">Suitable for Dry,Damp and Wet Locations</p> <p style="text-align: right;">V+---RED ○<br/>V- ---BLACK ○<br/>DIM+---PURPLE ○<br/>DIM---GRAY ○</p> <p style="text-align: center;"> <b>RoHS SELV</b>     <b>IP65</b>  <b>UL</b><br/>E360758         </p>   |
| TUV/SAA/CE   |  |
| <p style="text-align: center;"> <b>MODEL:SS-120C-40B</b></p> <p style="text-align: center;"><b>SOSEN</b> Constant Current LED Driver</p> <p>○ ACL--BROWN<br/>○ ACN--BLUE<br/>○ --GREEN/YELLOW<br/>MADE IN CHINA<br/><a href="http://www.szsofen.com">HTTP://www.szsofen.com</a></p>   | <p style="text-align: center;"><b>Manufacturer: Shenzhen Sosen Electronics Co.,Ltd</b></p> <p style="text-align: center;">A3 building, Gonghe Fourth Industrial Area, Shajing Street, Baoan District, 518104 Shenzhen, PEOPLE'S REPUBLIC OF CHINA</p> <p><b>INPUT: 100-277V~ 1.5A 50/60Hz</b> <span style="float: right;"><math>t_c: 85^\circ\text{C}</math><br/><math>t_a: 60^\circ\text{C}</math></span></p> <p><b>OUTPUT: 24-40V<math>\equiv</math> 2.0-3.75A Max.42V Max.120W</b></p> <p style="text-align: center;">Suitable for Dry,Damp and Wet Locations</p> <p style="text-align: center;">For LED modules use only</p> <p style="text-align: right;">V+---BROWN ○<br/>V- ---BLUE ○<br/>DIM+---PURPLE ○<br/>DIM---GRAY ○</p> <p style="text-align: center;"> <b>RoHS SELV</b>     <b>IP65</b>   <b>GS</b> </p> |
| CCC  |  |
| <p style="text-align: center;"> <b>MODEL (型号) : SS-120C-40B</b></p> <p style="text-align: center;"><b>SOSEN</b> LED DRIVER(LED模块用交流电子控制装置)</p> <p>INPUT (输入端)<br/>○ ACL--BROWN (棕)<br/>○ ACN--BLUE (蓝)<br/>○ --GREEN/YELLOW (绿黄)<br/><a href="http://www.szsofen.com">HTTP://www.szsofen.com</a><br/>MADE IN CHINA 制造地: 中国</p> | <p style="text-align: center;"><b>Manufacturer: Shenzhen Sosen Electronics Co.,Ltd</b></p> <p style="text-align: center;">制造商: 深圳市崧盛电子股份有限公司</p> <p><b>INPUT(输入): 100-240V~ 1.5A 50/60Hz</b> <span style="float: right;"><math>t_c: 85^\circ\text{C}</math><br/><math>t_a: 60^\circ\text{C}</math></span></p> <p style="text-align: center;">277V~ 0.7A 50/60Hz<br/>(277V~只适用于北美)</p> <p><b>OUTPUT(输出): 24-40V<math>\equiv</math> 2.0-3.75A Max.42V</b></p> <p style="text-align: center;">输出功率: 120W(LED模块)</p> <p style="text-align: right;">OUTPUT (输出端)<br/>V+---BROWN (棕) ○<br/>V- ---BLUE (蓝) ○<br/>DIM+---PURPLE (紫) ○<br/>DIM---GRAY (灰) ○</p> <p style="text-align: center;"> <b>RoHS SELV</b>     <b>IP65</b>   </p>  |
| BIS  |  |
| <p style="text-align: center;"> <b>MODEL:SS-120C-40B</b></p> <p style="text-align: center;"><b>SOSEN</b> LED Driver</p> <p>○ ACL--BROWN<br/>○ ACN--BLUE<br/>○ --GREEN/YELLOW<br/>MADE IN CHINA<br/><a href="http://www.szsofen.com">HTTP://www.szsofen.com</a></p>   | <p style="text-align: center;"><b>MANUFACTURER: SHENZHEN CITY SOSEN ELECTRONICS CO.,LTD</b></p> <p><b>INPUT: 100-277V~ 1.5A 50/60Hz</b> <span style="float: right;"><math>t_c: 85^\circ\text{C}</math><br/><math>t_a: 60^\circ\text{C}</math></span></p> <p><b>OUTPUT: 24-40V<math>\equiv</math> 2.0-3.75A Max.42V Max.120W</b></p> <p style="text-align: center;">Suitable for use in Dry, Damp and Wet Locations</p> <p style="text-align: center;">For LED modules use only</p> <p style="text-align: right;">V+---BROWN ○<br/>V- ---BLUE ○<br/>DIM+---PURPLE ○<br/>DIM---GRAY ○</p> <p style="text-align: center;"> <b>RoHS SELV</b>     <b>IP65</b>   </p> <p style="text-align: right; font-size: small;">IS15885Part 2(Rev 13)<br/>R-41041440</p>  |

### Dimming Diagram



- Output current could be adjusted by connecting 0-10V or PWM signal between DIM+ and DIM-
- DO **NOT** connect DIM- and V- to avoid abnormal output

#### 0-10V Dimming(Typ.), See Fig. 8

| Voltage Range            | 1V  | 2V  | 3V  | 4V  | 5V  | 6V  | 7V  | 8V  | 9V  | 10V  | OPEN     |
|--------------------------|-----|-----|-----|-----|-----|-----|-----|-----|-----|------|----------|
| Rated current percentage | 10% | 20% | 30% | 40% | 50% | 60% | 70% | 80% | 90% | 100% | 95%-108% |

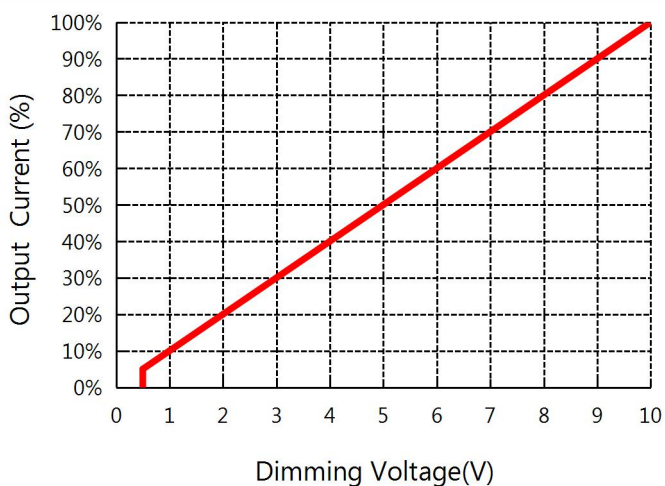
#### 10V PWM frequency range (Typ.): 200Hz-2KHz, See Fig. 9

| PWM duty                 | 10% | 20% | 30% | 40% | 50% | 60% | 70% | 80% | 90% | 100% | OPEN     |
|--------------------------|-----|-----|-----|-----|-----|-----|-----|-----|-----|------|----------|
| Rated current percentage | 10% | 20% | 30% | 40% | 50% | 60% | 70% | 80% | 90% | 100% | 95%-108% |

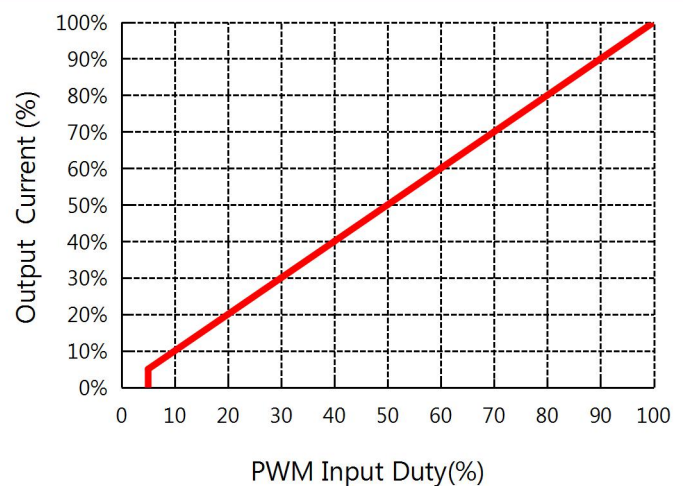
#### Resistor (Typ.), N represents the number of power supplies

| Resistor                 | 10KΩ | 20KΩ | 30KΩ | 40KΩ | 50KΩ | 60KΩ | 70KΩ | 80KΩ | 90KΩ | 100KΩ | OPEN     |
|--------------------------|------|------|------|------|------|------|------|------|------|-------|----------|
|                          | /N   | /N   | /N   | /N   | /N   | /N   | /N   | /N   | /N   | /N    | OPEN     |
| Rated current percentage | 10%  | 20%  | 30%  | 40%  | 50%  | 60%  | 70%  | 80%  | 90%  | 100%  | 95%-108% |

**Fig. 8 0-10V Dimming Curve**



**Fig. 9 PWM Dimming Curve**



## Installation Tips

1. Highly recommended to seal the adjustable hole with silicon glue (#704 preferred) after adjusting the driver's output current. Torsion with proper strength to avoid permanent damage to the potentiometer inside.
2. Pls confirm the integrity of the product if the package is broken when you receive goods, and the crack is not allowed on the outside of the driver's structure.
3. The screw thread need to meet the length of 15-22mm and integrate to the thread hole of the driver tightly and firmly and make sure all the screws and ring are locked firmly.
4. Whole luminaire's wight should be less than 11kg with the driver(1.2kg).
5. Dimming leads should be capped if not in use to avoid dimming circuit damage caused by external signals.

## Package, Transportation & Storage

### 1. Package

- Outside carton dimension: L×W×H =500mm×390mm×170mm;
- 10PCS/Carton;
- Net weight/PC: 1.2kg;
- Gross weight/Carton: 13kg.

### 2. Transportation

Packaging is designed suitable for transportation by trucks, vessels and flights. The products should be shielded from direct sunshine, loaded/unloaded with caution.

### 3. Storage

The product storage meets the standard of the GB 3873—83.

Products should be rechecked if stock for over 1 year before installation.