

Architecture Selectable LED Linear Light

Tunable Wattages:(2FT)15W/20W/25W ; (4FT)40W/45W/50W ; (8FT)65W/75W/90W

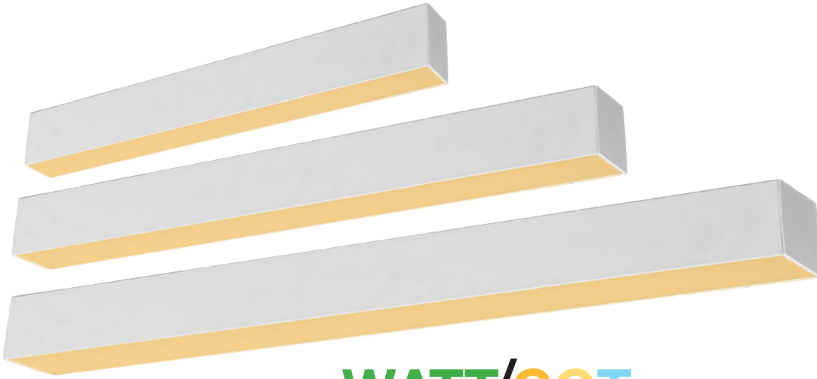

The Architecture Selectable LED Linear Light Series can be widely used for indoor (damp locations) Excellent for hospitals, schools, office, shops, restaurants, storage rooms, supermarkets, etc.

WATT/CCT
FIELD-ADJUSTABLE



TOP FEATURES

- 130 lm/W⁽¹⁾, 1,950lm-11,700lm, DLC 5.1.
- Field-adjustable Power and CCT.
- Direct-Indirect flux ratio adjustable.
- Continuous run available.
- Multiple connection method.
- Motion Sensor Control Available (Option)

Dimensions

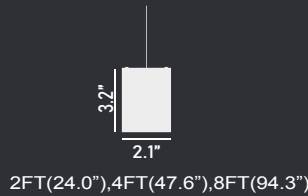

Distributions

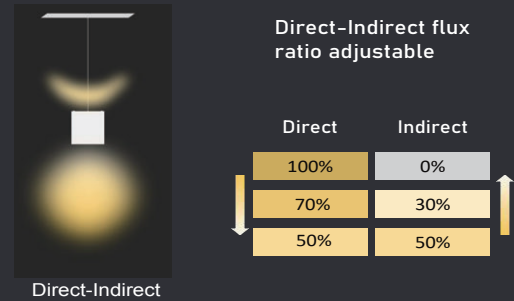

SPECIFICATION

TYPE	WSD-OL2FT152025W27-3545K-W	WSD-OL4FT404550W27-3545K-W	WSD-OL8FT657590W27-3545K-W
WATTAGE	(2FT) 15W/20W/25W	(4FT) 40W/45W/50W	(8FT) 65W/75W/90W
LUMEN	1950 lm/2600lm/3250lm	5200 lm/5850lm/6500lm	8450 lm/9750 lm/11700 lm
EFFICACY	> 130 lm/W		
CCT	3500K/4000K/5000K		
DEFAULT SETTING	25W&4000K	50W&4000K	90W&4000K
CRI	80		
INPUT VOLTAGE	AC120-277V		
LIGHT ANGLE	360°		
POWER FACTOR	0.90		
DRIVER EFFICACY	86%		
DIMMING	1-10V Dimming		
WORKING TEMPERATURE	-4°F ~ 122°F		
LIFESPAN (L70)	100,000 hours		
PROTECTION LEVEL	Damp locations		
CABLE	5core,18AWG (59.06 inch)		
WARRANTY	5 year limited		

Architecture Selectable LED Linear Light

Tunable Wattages:(2FT)15W/20W/25W ; (4FT)40W/45W/50W ; (8FT)65W/75W/90W

DIMENSION

Unit:mm/inch

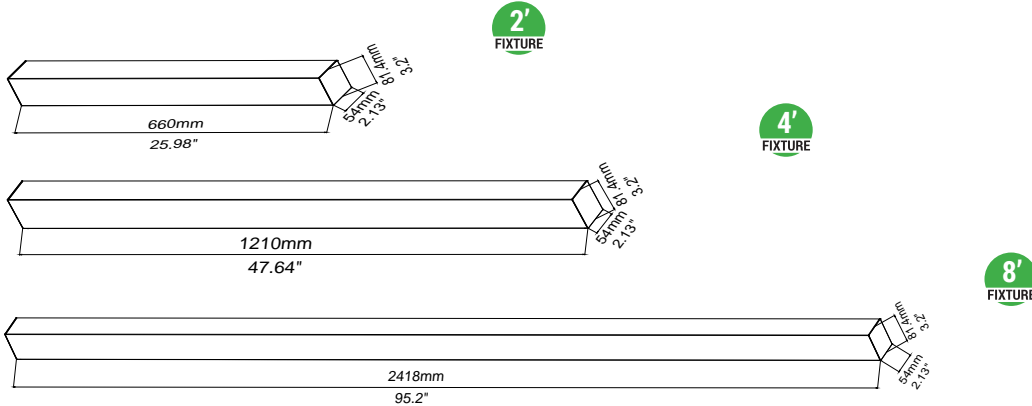

WATTAGE	15W/20W/25W
GR. WEIGHT	2.65 lbs (6 pcs/carton)
OUTER BOX	30.04"X10.28"X7.87"

WATTAGE	40W/45W/50W
GR. WEIGHT	4.41 lbs (6 pcs/carton)
OUTER BOX	53.78"X9.84"X7.87"

WATTAGE	65W/75W/90W
GR. WEIGHT	4.41 lbs (4 pcs/carton)
	101.65"X10.08"X5.24"

EMERGENCY BACK-UP (SOLD SEPARATELY)



(Available only for 4FT and 8FT models)

WSD-EMS8W27-XX
8W Emergency Backup Battery LED Driver

WSD-EMS15W27-XX
15W Emergency Backup Battery LED Driver

WSD-EMS20W27-XX
20W Emergency Backup Battery LED Driver

CONTROL (SOLD SEPARATELY)

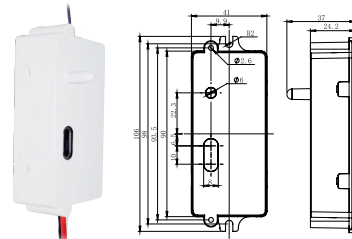

BRI810-B-D
Microwave Motion Sensor



RC-100
Microwave Sensor Remote Controller

STANDARD ACCESSORIES(standard)

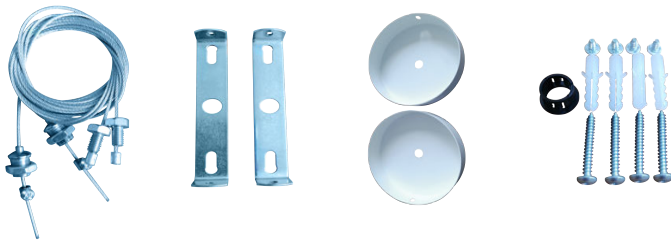

WSD-OL-CABLE
39.37 inch CABLE (2FT,4FT,8FT)

WSD-OL-CROSS-BAR
CROSS-BAR (2FT,4FT,8FT)

WSD-OL-CANOPY
CANOPY (2FT,4FT,8FT)

WSD-OL-SRP
SCREW+RUBBER PLUG (2FT,4FT,8FT)

STANDARD ACCESSORIES(SOLD SEPARATELY)

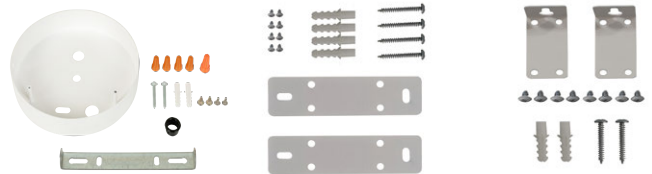

WSD-OL-CANOPY-M
CANOPY Suitable for installation with Motion Sensor (2FT,4FT,8FT)

WSD-OL-SMK
SURFACE MOUNTING KIT (2FT,4FT,8FT)

WSD-OL-WMK
WALL MOUNTING KIT (2FT,4FT,8FT)

ORDERING INFORMATION

EXAMPLE: WSD-OL2FT152025W27-3545K-Z[D,W,B,S]-E[Blank,EC,M,ECM]

WSD	OL	2FT	152025	27	3545K	Z	E
PRODUCT	PRODUCT	SIZE	WATTAGE	VOLTAGE	CCT	FINISH	CONTROL
WSD (WSD LED INC)	OL (LED Linear Light)	2FT (2-foot)	152025W - (15W/20W/25W)	27 - (120-277V)	3545K - (3500K/4000K/5000K)	D (Dark Bronze) W (White) B (Black) S (Silvery)	M (Motion Sensor) EC (Emergency) ECM (Emergency+Motion Sensor)
		4FT (4-foot)	404550W - (40W/45W/50W)				
		8FT (8-foot)	657590W - (65W/75W/90W)				

Architecture Selectable LED Linear Light

Tunable Wattages:(2FT)15W/20W/25W ; (4FT)40W/45W/50W ; (8FT)65W/75W/90W

MULTIPLE CONNECTION METHOD (SOLD SEPARATELY)

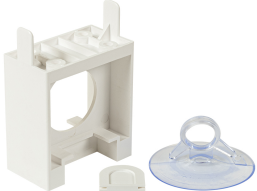
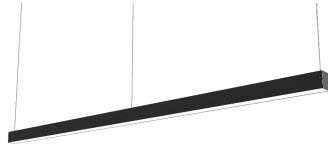
 <p>WSD-OL180-2T "I" connector</p>	 <p>"I" connecting with Straight shape connector</p>	

CONNECTING AND WIRING:

Power cord with rubber cable sheath, fixed to the pre-punched hole on one side of the fixture body

Both ends of the fixture has 2 connectors for wiring connection.

Female 3 pin JST SM Connector to light up the joiners.

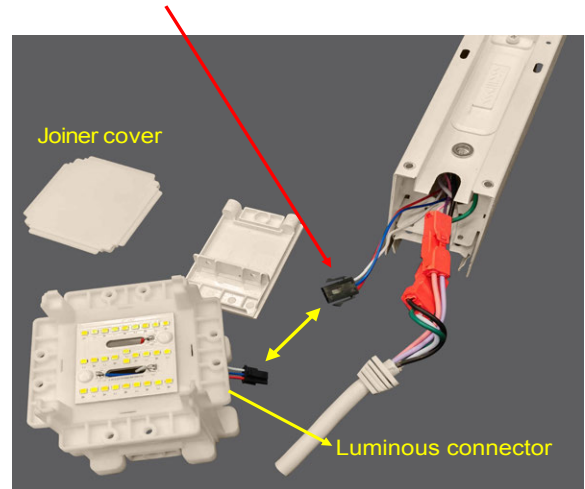
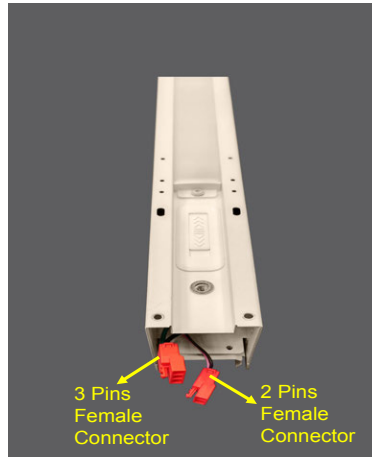
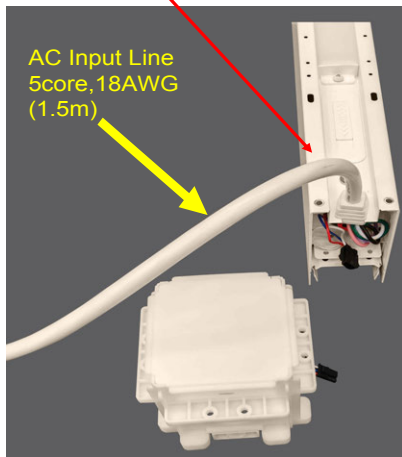

CONTROL MODULE:

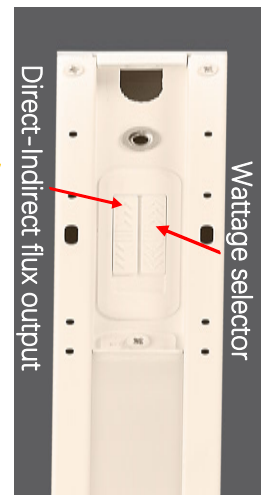

Architecture Selectable LED Linear Light

Tunable Wattages:(2FT)15W/20W/25W ; (4FT)40W/45W/50W ; (8FT)65W/75W/90W

PHOTOMETRICS

For complete IES files, please visit our website.

WSD-OL2FT152025W27-3545K (25W&4000K)

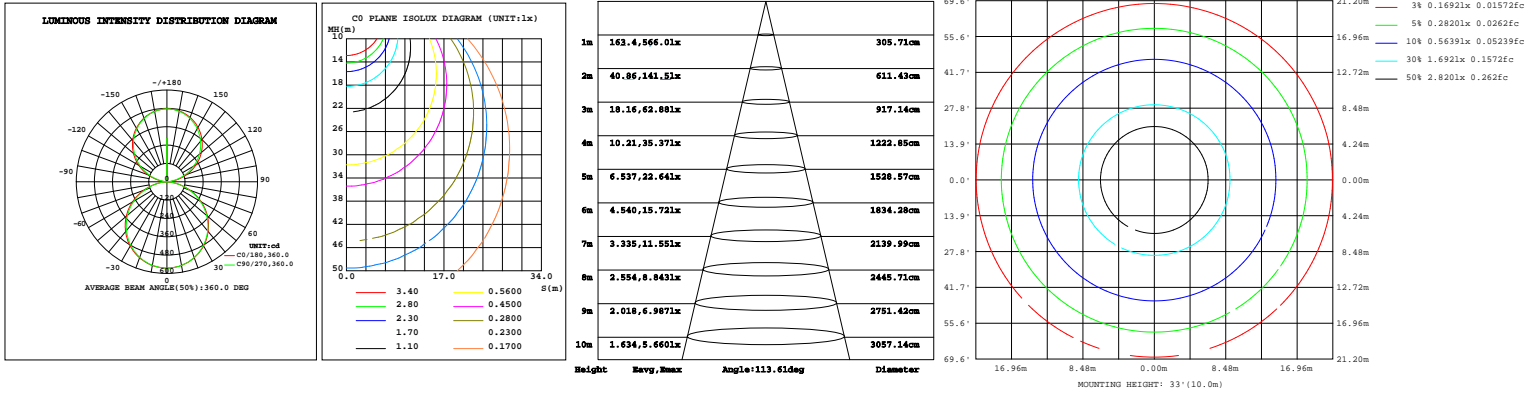

WSD-OL4FT404550W27-3545K (50W&4000K)

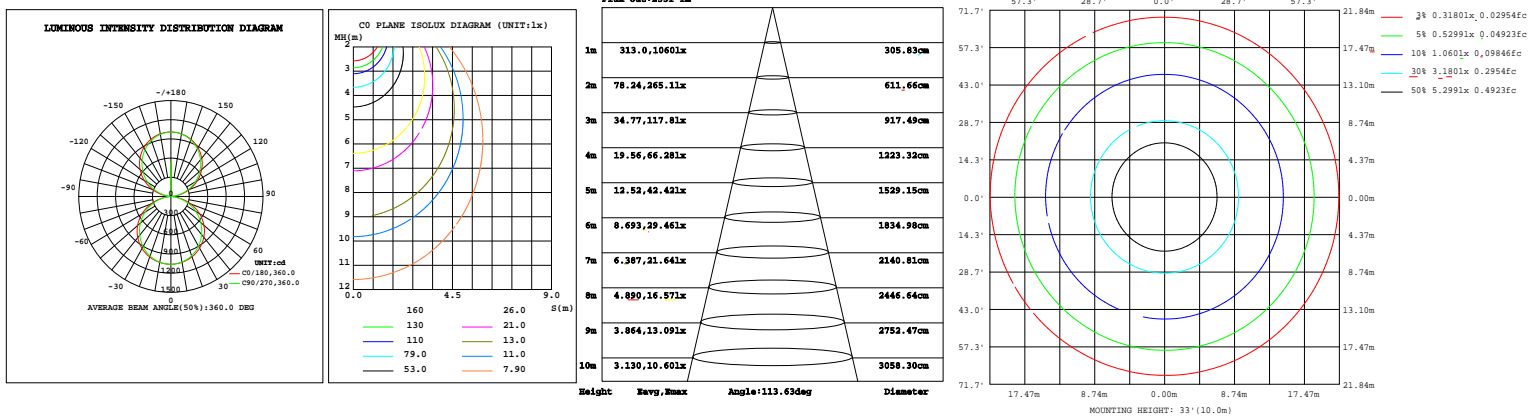

WSD-OL8FT657590W27-3545K (90W&4000K)

