

LED Architectural Wall Pack Series

Selectable Wattages: (28W/42W/56W/70W) (48W/72W/96W/120W)

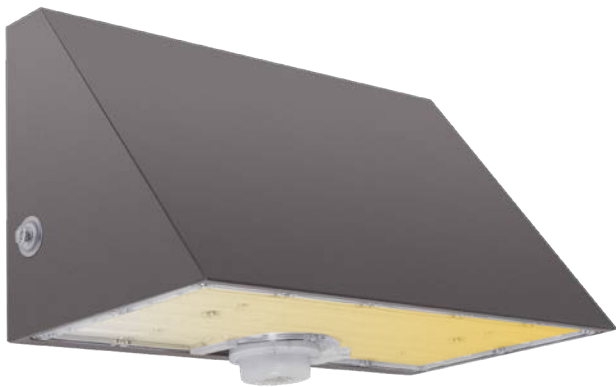

LED Architectural Wall Pack series can be widely used in indoor or outdoor lighting (wet location). Ideal for museums, art galleries, shopping malls, office buildings, walls and many other applications.

WATT/CCT
SELECTABLE



ROHS
COMPLIANT



FEATURES

- LED high luminous efficiency and long working life.
- High efficiency LED Driver, the wide range input voltage AC120-277V / 277-480V.
- Die-cast aluminum cooling design, high quality and better cooling for LED $T_j < 85^{\circ}\text{C}$.
- Excellent optics design, greatly improve the light utilization and evenness.
- Photocell , Wireless bluetooth system and Motion sensor control available (Optional)
- 12Vdc auxiliary dimming
- The 1-10V Dimming type is continuous.

High performance, die-cast heat sink transfers heat from the light engine to the environment, drawing heat away from the fixture, and extending the lifespan of the LEDs.



 **Bluetooth®**
(Option)

Easy field-install motion sensor

SPECIFICATION

WATTAGE	28W	42W	56W	70W	48W	72W	96W	120W
LUMEN (4000K Type III)	> 4760 lm	> 6880 lm	> 8601 lm	> 11124 lm	> 7800 lm	> 11288 lm	> 14627 lm	> 18550 lm
EFFICACY	> 151 lm/W							
CCT (Asserted)	3000K, 4000K, 5000K				4000K, 5000K			
CRI	> 70							
INPUT VOLTAGE	AC120-277V/277-480V							
BEAM ANGLE	Type III: 93.5° X 87.4° (option) / Type IV: 94.3° X 76.8° (option) / Type V: 107.3° X 104.9° (option)							
POWER FACTOR	0.90							
DRIVER EFFICACY	≥89%							
FACTORY SETTINGS	70W & 4000K				120W & 4000K			
LIFE SPAN	over 50,000 hrs							
WORKING TEMPERATURE	-22°F ~ 113°F							
STORAGE TEMPERATURE	-40°F ~ 176°F							
OUTDOOR RATING	Wet location							
CABLE	3 core, 18AWG (11.8 inch)							
WARRANTY	5 year limited							

LED Architectural Wall Pack Series

Selectable Wattages: (28W/42W/56W/70W) (48W/72W/96W/120W)

PERFORMANCE

SPECIFICATION																		
TYPE	WSD-AFW2842567W27-345K-D-TN																	
POWER	28W(Tested Light Output)									42W(Tested Light Output)								
DISTRIBUTION	TYPE III			TYPE IV			TYPE V			TYPE III			TYPE IV			TYPE V		
CCT	3000K	4000K	5000K	3000K	4000K	5000K	3000K	4000K	5000K	3000K	4000K	5000K	3000K	4000K	5000K	3000K	4000K	5000K
LUMENS	4566	4760	4734	4498	4727	4688	4519	4741	4703	6452	6880	6746	6411	6816	6700	6424	6831	6715
EFFICACY	> 160	> 170	> 165	> 157	> 170	> 163	> 158	> 170	> 164	> 152	> 168	> 158	> 151	> 166	> 157	> 151	> 166	> 157
TYPE	WSD-AFW2842567W27-345K-D-TN																	
POWER	56W(Tested Light Output)									70W(Tested Light Output)								
DISTRIBUTION	TYPE III			TYPE IV			TYPE V			TYPE III			TYPE IV			TYPE V		
CCT	3000K	4000K	5000K	3000K	4000K	5000K	3000K	4000K	5000K	3000K	4000K	5000K	3000K	4000K	5000K	3000K	4000K	5000K
LUMENS	7918	8601	8249	7864	8440	8192	7883	8460	8211	9911	11124	10580	9553	10751	10163	9573	10764	10568
EFFICACY	> 146	> 163	> 151	> 145	> 162	> 150	> 145	> 162	> 150	> 140	> 160	> 150	> 135	> 155	> 145	> 135	> 155	> 150

SPECIFICATION													
TYPE	WSD-AFW48729612W27-45K-D-TN												
POWER	48W(Tested Light Output)						72W(Tested Light Output)						
DISTRIBUTION	TYPE III		TYPE IV		TYPE V		TYPE III		TYPE IV		TYPE V		
CCT	4000K	5000K	4000K	5000K	4000K	5000K	4000K	5000K	4000K	5000K	4000K	5000K	
LUMENS	7800	7870	7735	7823	7745	7843	11288	11330	11153	11195	11223	11247	
EFFICACY	> 158	> 156	> 157	> 155	> 158	> 156	> 155	> 151	> 153	> 149	> 154	> 150	
TYPE	WSD-AFW48729612W27-45K-D-TN												
POWER	96W(Tested Light Output)						120W(Tested Light Output)						
DISTRIBUTION	TYPE III		TYPE IV		TYPE V		TYPE III		TYPE IV		TYPE V		
CCT	4000K	5000K	4000K	5000K	4000K	5000K	4000K	5000K	4000K	5000K	4000K	5000K	
LUMENS	14627	14487	14429	14324	14505	14366	18550	17974	17873	17373	17342	16869	
EFFICACY	> 151	> 143	> 149	> 142	> 150	> 142	> 155	> 150	> 150	> 145	> 145	> 140	

LED Architectural Wall Pack Series

Selectable Wattages: (28W/42W/56W/70W) (48W/72W/96W/120W)

DIMENSION

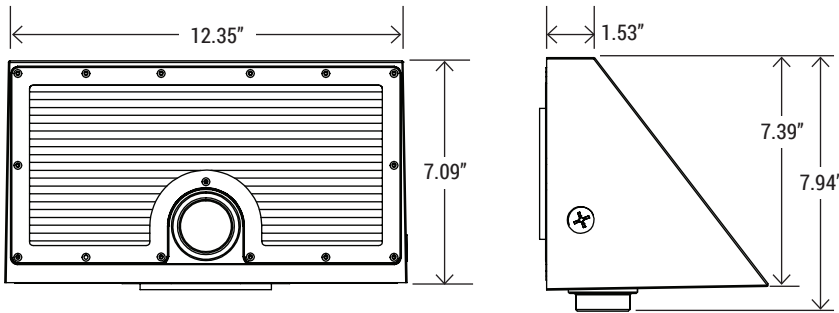

WATTAGE	28W-70W	48W-120W
NT. WEIGHT	8.14 lbs	8.60 lbs
BOX DIM.	13.58" x 7.87" x 8.27"	

EMERGENCY BACK-UP (SOLD SEPARATELY)



WSD-EMS8W27-XX
8W Emergency Backup
Battery LED Driver

(Available only for
28-70W low-voltage
models)

WSD-EMS15W27-XX
WSD-EMS20W27-XX
15W/20W Emergency
Backup Battery LED
Driver

YH28A-08WL-180-X
8W Emergency Backup
Battery LED Driver

(Low voltage
models only)

CONTROL (SOLD SEPARATELY)



Bluetooth

ANT-5-4T-BLE-SR
Bluetooth
Microwave
Motion Sensor

ANT-5-4T
Bi-level
microwave Sensor

RC100
Remote
Controller

*MESH RANGE

60ft node-to-node and 500ft node-to-Gateway (Commissioning)

PHOTOCELL STANDARD

P (Photocell)

Bluetooth
(Option)

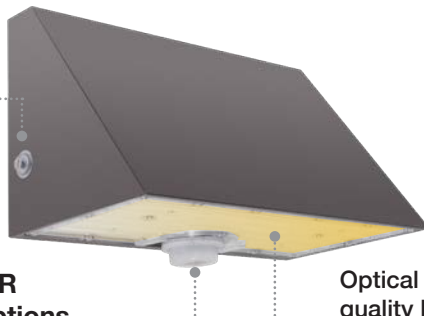

**MOTION SENSOR
and Bluetooth options**

Optical lens is made of high
quality PC material to make
the light even and soft.

WATT/CCT SELECTABLE



ORDERING INFORMATION

EXAMPLE:

WSD-AFW2842567W27-345K-D-TN-P-M / WSD-AFW48729612W27-45K-D-TN-P-M

WSD	AFW	2842567W	27	345K	D	TN	P	M
COMPANY	PRODUCT	WATTAGE	VOLTAGE	CCT	FINISH	DISTRIBUTION	CONTROL	CONTROL
WSD LED INC	AFW LED Architectural Wall Pack	2842567W - (28W/42W/ 56W/70W) 48729612W - (48W/72W/ 96W/120W)	27 (AC120-277V) 48 (AC277-480V)	345K - (3000K/4000K/5000K) 45K - (4000K/5000K)	D - (Dark Bronze) W - (White) B - (Black) S - (Silver)	T3 - (Type III) T4 - (Type IV) T5 - (Type V)	AC120-277V P - (Photocell) AC277-480V (No Photocell)	M - (Motion Sensor)

LED Architectural Wall Pack Series

Selectable Wattages: (28W/42W/56W/70W) (48W/72W/96W/120W)



ANT-5-4T-BLE-SR

Plug and Play Network BLE Nodes and Sensor

The Bluetooth Lighting Control provides automated individual and group control of light fixtures using on sensors and Bluetooth mesh technology. The ANT-5-4T-BLE-SR mounted in an Commercial lighting fixture and provides multi-level control solution based on motion and or daylight harvesting contribution.

FEATURES

- Lighting controls meet design lights consortium (DLC) networked lighting control system technical requirements.
- Quick connect and adjust different sensor angle.
- Easy commissioning with Mobile App (Available in IOS).
- Bluetooth network with Saas working by computer
- Individual addressability and/or grouping.
- Time clock scheduling for individual lights, groups or scenes.
- Multi-level dimming: manual ON/OFF automatic ON/OFF, and automatic partial ON/OFF, daylight harvesting control capability.

DIMENSION

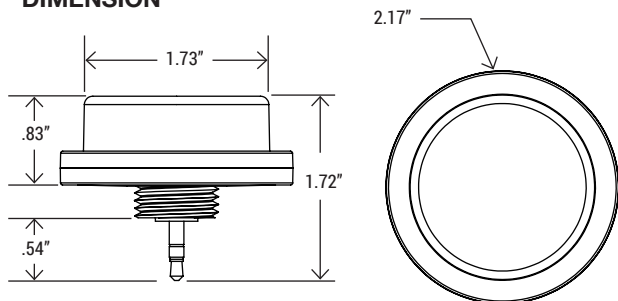

COVERAGE

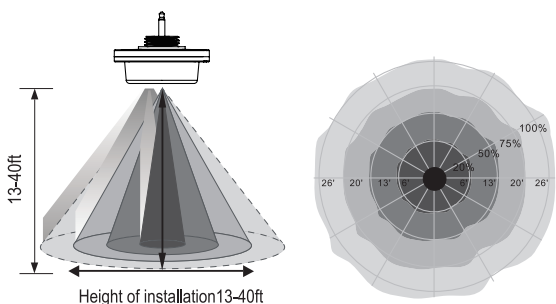

SPECIFICATION

NETWORK BLE MESH	Yes
DAYLIGHT HARVESTING	Yes
MICROWAVE MOTION SENSOR	Yes
DETECTION MODE	Occupancy/Vancancy/Bi-level in 1 Unit
OPERATING VOLTAGE	12-24V DC
OPERATING CURRENT	>50mA
SINKING CURRENT	max. 25mA
CONTROL OUTPUT	0-10V
RADIO FREQUENCY	2.4GHz ± 75MHz
WIRELESS STANDARD	BLE 5.0 MESH
PROGRAMMING	Silvair iOS App (IOS)
CYBERSECURITY	UL
ENCRYPTION	AES 128-bit
MESH RANGE	60ft node-to-node and 500ft node-to-device (Commissioning)
SAFETY	cULus Listed
FCC	FCC
OPERATING TEMP.	-20°C - +60°C
IP RATING	IP65
WARRANTY	5 year limited

MICROWAVE SENSOR FEATURES

DAYLIGHT HARVESTING	On/Off
MOTION SENSING	On/Off
FIRST TIME DELAY	1-59 mins/infinite
SECOND TIME DELAY	0-59 mins/infinite
DIM LEVEL	0-100%
MOUNTING HEIGHT	13-40ft
DETECTION RANGE	up to 52ft diameter
DETECTION: HORIZONTAL	360°
DETECTION: VERTICAL	90°

COMMISSIONING

Silvair iOS App makes it easy to pair devices, create groups, set scenes/schedules, customize dimming levels, and adjust high trim based on application needs.

Please scan and download the app.



iOS

Operation Instruction:
https://youtu.be/8KWPK7z_Tng

LED Architectural Wall Pack Series

Selectable Wattages: (28W/42W/56W/70W) (48W/72W/96W/120W)

GateWay Remote Control

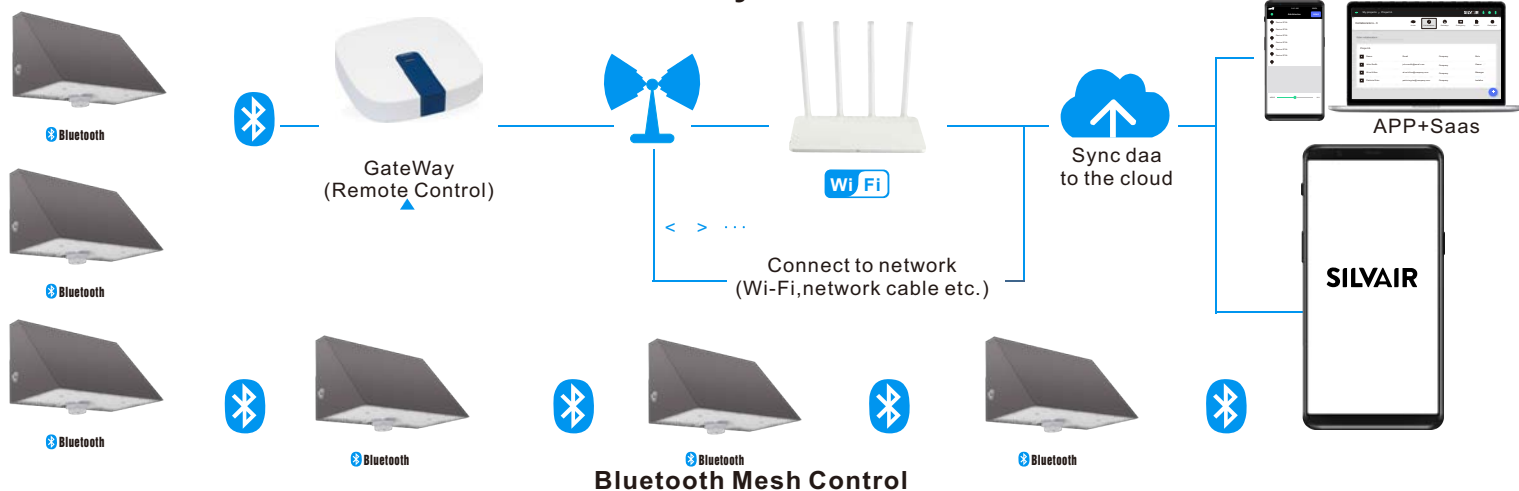

Functions:

- The Silvair Gateway enables the following functions in the Silvair web app: •
- Scheduling (available by default)
 - o Scheduling changes in scenes and lighting control scenarios (for example occupancy sensing, daylight harvesting) for specific times or days.
 - Energy and occupancy monitoring (additional paid service)
 - o Visualizing energy use and occupancy via the Silvair web app.
 - o Downloading energy and occupancy via the Silvair web app and cloud-based API.
 - Remote monitoring and control (additional paid service)
 - o Low-latency monitoring of the status of devices in the network via API.
 - o Low-latency control of devices in the network via API.
 - System diagnostics
 - o Monitoring of the status of Bluetooth mesh networks.
 - o Remote troubleshooting of networking issues.

Features:

- Future-proof Linux operating system.
- Simple commissioning using the Silvair Commissioning tools.
- Automatic connection to the Silvair cloud.
- Secure provisioning with secure IDs and encrypted keys.
- High level of hardware and software security (secure boot and encrypted file system can only be accessed with the management platform).
- Automatic security updates.
- Prompt releases of OS updates and fixes to vulnerabilities.
- Low-latency transfer of network, luminaire, and sensor status data to the Silvair cloud.
- Schedule caching.
- Automatic remote firmware updates.
- Display of gateway and network performance metrics (requires the Silvair web app).

INDUSTRIAL GATEWAY

SGW-101

Smart Engineering Gateway

The Silvair Gateway connects Bluetooth mesh networks that have been commissioned using the Silvair Commissioning tools to the Silvair cloud. This allows the scheduling of events and delivery of services based on the data generated by these networks.

SPECIFICATION

POWER SUPPLY	4.5–5.5 V DC, 2 A Power over Ethernet 36–57 V DC (IEEE 802.3af)
OPERATING SYSTEM	Ubuntu Core
PROCESSOR	i.MX6ULL (Y2), 32-bit ARM 800 MHz
MEMORY	512 MB DDR3L SDRAM 8GB eMMC
COMMUNICATION PROTOCOLS	Bluetooth mesh (2.4 GHz Bluetooth Low Energy) Wi-Fi 802.11a/b/g/n/ac (2.4/5 GHz) 4G LTE Cat 1 with 2G/3G (only for Cascade-500-W and Cascade-500-X gateways)
PORTS	1 x RJ45 10/100 Ethernet 1 x USB 2.0 Type-A 2 x external dipole antenna, 5 dBi (only for Cascade-500-W and Cascade-500-X gateways)
REQUIRED AMBIENT TEMPERATURE	0°C to 60°C 32°F to 140°F
ENCLOSURE DIMENSIONS	127 mm x 127 mm x 30 mm (5 inch x 5 inch x 1.2 inch)
MOUNTING POSITION	Wall or surface mounted. As close to the geometrical center of the lighting network as possible, but as far as possible from potential sources of interference.
SECURITY	Secure boot with encrypted operating system Secure communication with the Silvair Cloud over Internet (TLS) Secure communication with devices over qualified Bluetooth mesh

LED Architectural Wall Pack Series

Selectable Wattages: (28W/42W/56W/70W) (48W/72W/96W/120W)

PHOTOMETRICS

For complete IES files, please visit our website.

WSD-AFW2842567W27-345K-D-T3 (70W@5000K)

LUMINOUS INTENSITY DISTRIBUTION DIAGRAM

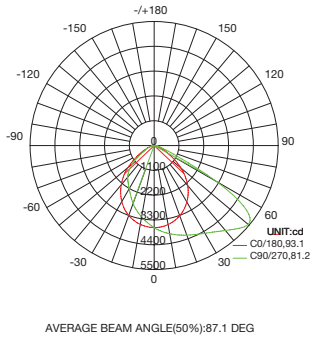

CO PLANE ISOLUX DIAGRAM (UNIT:lx)

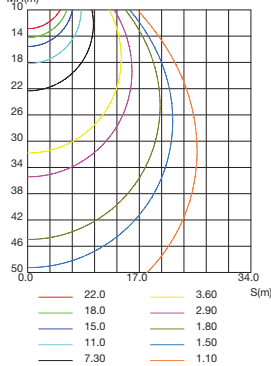

Flux out: 4909 lm

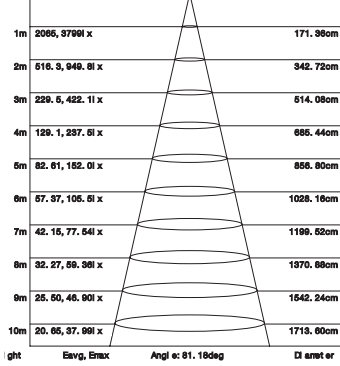

ISOLUX DIAGRAM

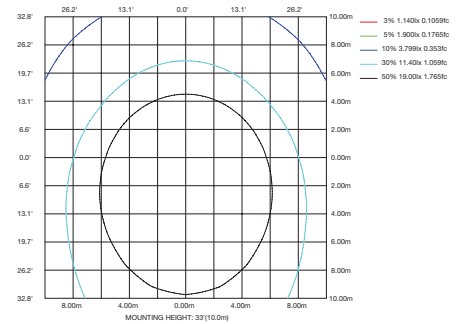

WSD-AFW2842567W27-345K-D-T4 (70W@5000K)

LUMINOUS INTENSITY DISTRIBUTION DIAGRAM

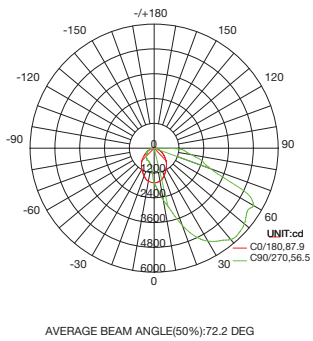

CO PLANE ISOLUX DIAGRAM (UNIT:lx)

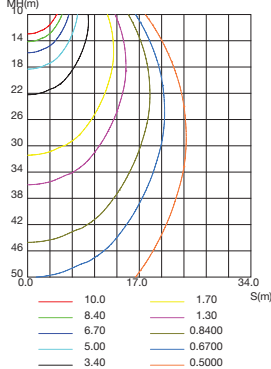

Flux out: 7446 lm

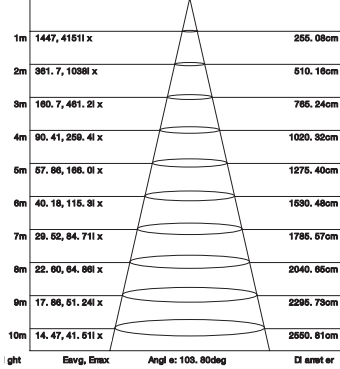

ISOLUX DIAGRAM

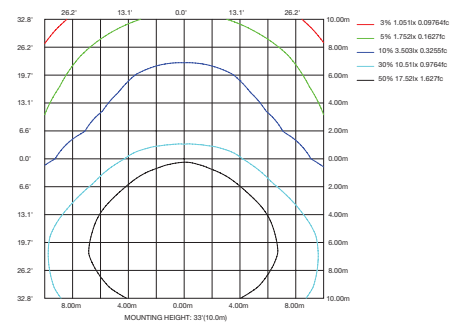

WSD-AFW2842567W27-345K-D-T5 (70W@5000K)

LUMINOUS INTENSITY DISTRIBUTION DIAGRAM

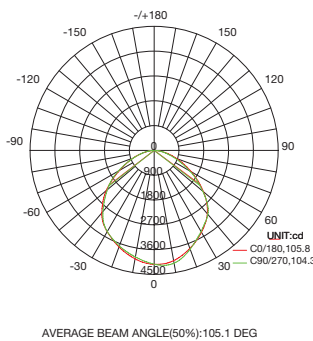

CO PLANE ISOLUX DIAGRAM (UNIT:lx)

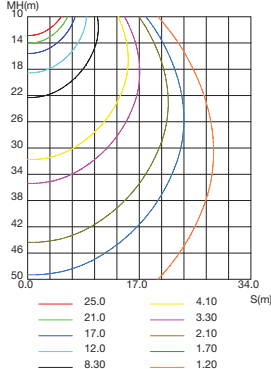

Flux out: 4909 lm

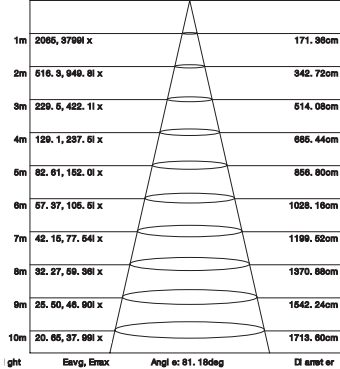

ISOLUX DIAGRAM

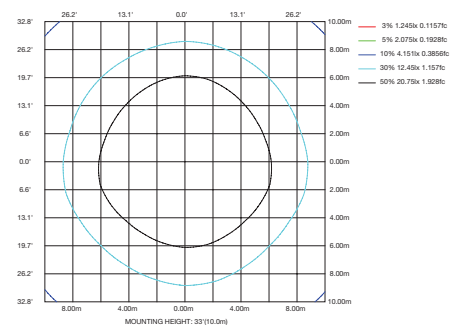

LED Architectural Wall Pack Series

Selectable Wattages: (28W/42W/56W/70W) (48W/72W/96W/120W)

PHOTOMETRICS

For complete IES files, please visit our website.

WSD-AFW48729612W27-45K-D-T3 (120W@5000K)

LUMINOUS INTENSITY DISTRIBUTION DIAGRAM

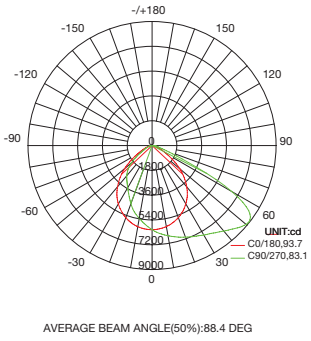

CO PLANE ISOLUX DIAGRAM (UNIT:lx)

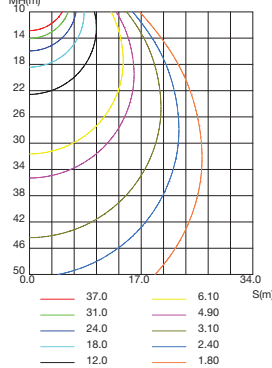

Flux out: 8600 lm

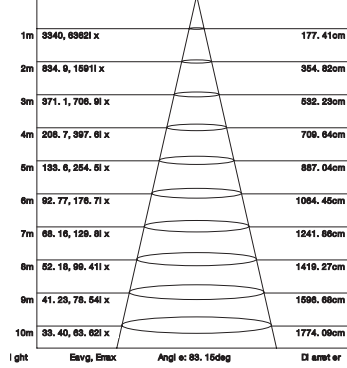

ISOLUX DIAGRAM

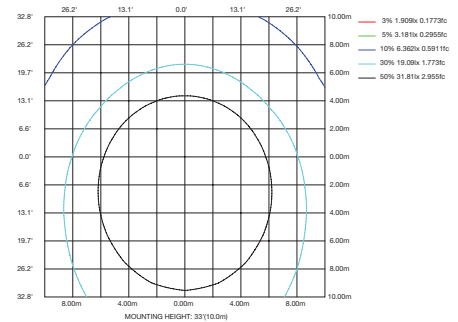

WSD-AFW48729612W27-45K-D-T4 (120W@5000K)

LUMINOUS INTENSITY DISTRIBUTION DIAGRAM

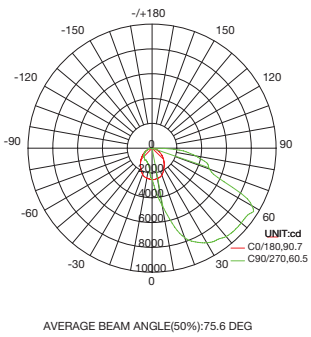

CO PLANE ISOLUX DIAGRAM (UNIT:lx)

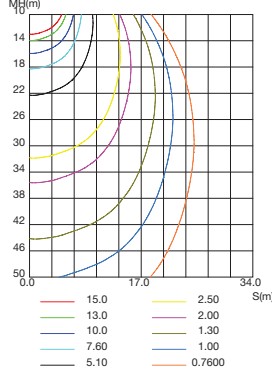

Flux out: 3025 lm

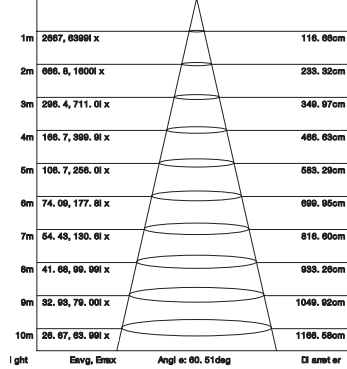

ISOLUX DIAGRAM

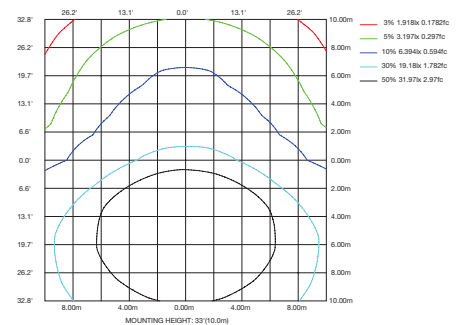

WSD-AFW48729612W27-45K-D-T5 (120W@5000K)

LUMINOUS INTENSITY DISTRIBUTION DIAGRAM

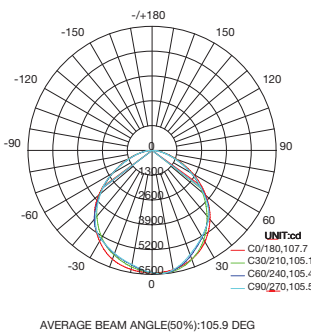

CO PLANE ISOLUX DIAGRAM (UNIT:lx)

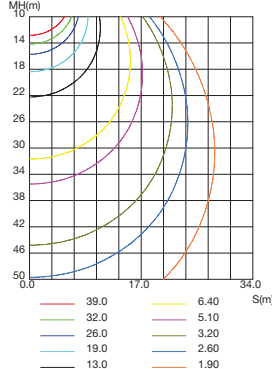

Flux out: 12080 lm

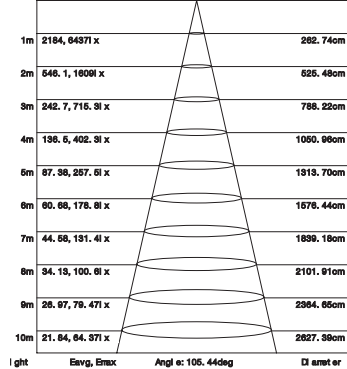

ISOLUX DIAGRAM

