

Selectable LED Surface Square Down Lights

Wattages: 10W , 15W , 20W

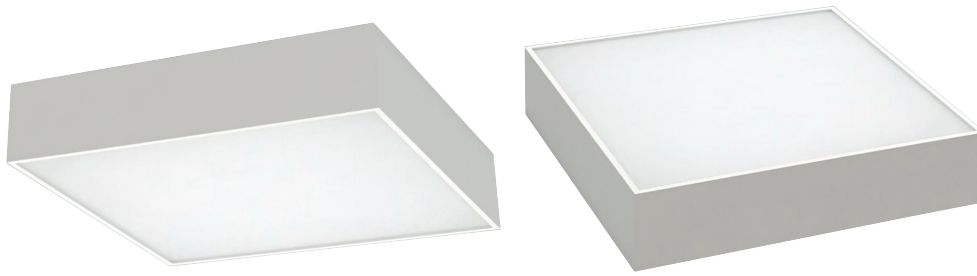

The Selectable LED Surface Square Down Light Series can be widely used for Indoor Excellent for Hallways, Multipurpose Rooms , Underground parking,super market, store and many other applications.

WATT/CCT
SELECTABLE



Features:

- Lumileds LED, high luminous efficiency and long working life.
- High efficiency LED Driver, the wide range input voltage AC120-347V.
- Excellent Optics design, greatly improve the light utilization and evenness.
- **The 0-10V Dimming type is continuous.**
- Motion sensor Control Available (Optional).

Packaging information:

❖ **WSD-SDW101520W347-345K-W:**

Carton Size: 540mmX380mmX290mm
21.26"X14.97"X11.42"(10Pcs/CTN)

Inside the box: 260mmX70mmX275mm
10.24"x2.76" x10.83"(1Pcs/CTN)

SPECIFICATION			
TYPE	WSD-SDW101520W347-345K-W		
WATTAGE	10W	15W	20W
LUMEN	1452 lm & 4000K	1927 lm & 4000K	2369 lm & 4000K
EFFICACY	> 120 lm/W		
CCT	3000K, 4000K, 5000K		
CRI	> 80		
INPUT VOLTAGE	AC120-347V		
LIGHTING ANGLE	108°		
FACTORY SETTINGS	20W & 4000K		
LED TYPE	2835		
PF	> 0.90		
DRIVER EFFICIENCY	> 88%		
PROTECTION LEVEL	Damp		
LIFE TIME	> 50000 hours		
WARRANTY	5 year limited		

Selectable LED Surface Square Down Lights

Wattages: 10W , 15W , 20W

Dimension:

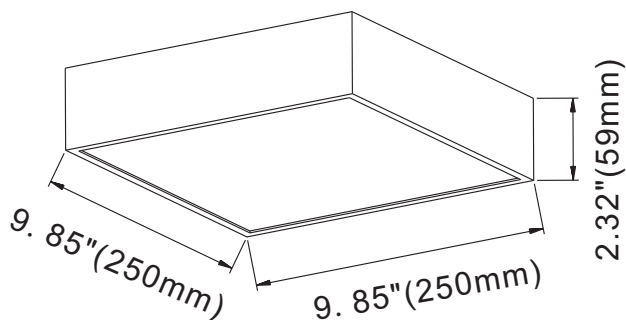

Specifications:

Shell materials: Aluminum & PC.
 Net weight : 0.97Kg (2.1 lbs)
 Finish: White(Standard)
 Product Size:250mmX250mmX59mm
 9.85"X9.85"X2.32"

Control Module:

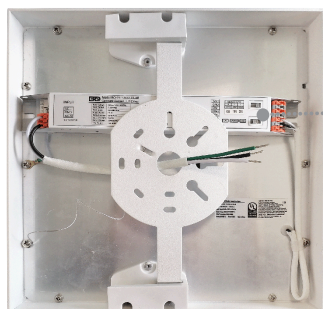

**WATT/CCT
SELECTABLE**



Selectable CCT

Three position sliding switch
3000K / 4000K / 5000K



Selectable Power

Three position sliding switch
10W / 15W / 20W



EMERGENCY BACK-UP (SOLD SEPARATELY)

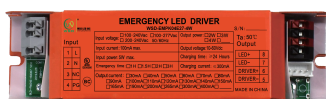

WSD-EMP04E27-4W
4W Emergency Backup
Battery LED Driver

CONTROL (SOLD SEPARATELY)



ANT-8A
Microwave Bi-level Sensor (12V DC)



RC100
Remote Controller

ORDERING INFORMATION:

EXAMPLE:

WSD-SDW101520W347-345K-Z[D,W,B,S]-E[Blank,EC,M,ECM]

WSD	SDW	101520	347	345K	Z	E
COMPANY	PRODUCT	POWER	VOLTAGE	CCT	FINISH	CONTROL
WSD LED INC	SDW Surface Square Down Lights	101520 10W/15W 20W	347 AC120-347V	345K 3000K/4000K/5000K	D (Dark Bronze) W (White) B (Black) S (Silvery)	EC (Emergency) M (Motion Sensor) ECM (Emergency+ Motion Sensor)

Selectable LED Surface Square Down Lights

Wattages: 10W , 15W , 20W

PHOTOMETRICS:

For complete IES files, please visit our website.

WSD-SDW101520W347-345K-W (20W&3000K)

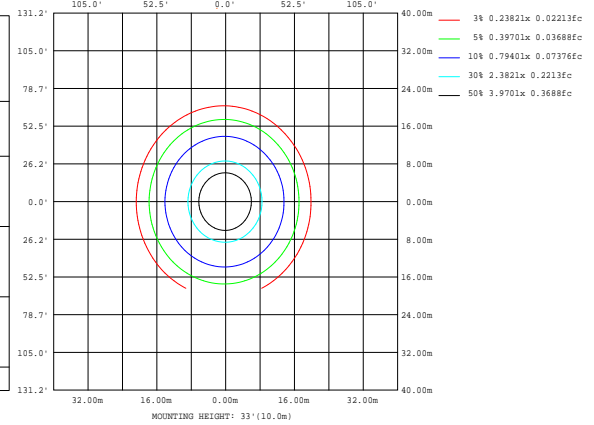
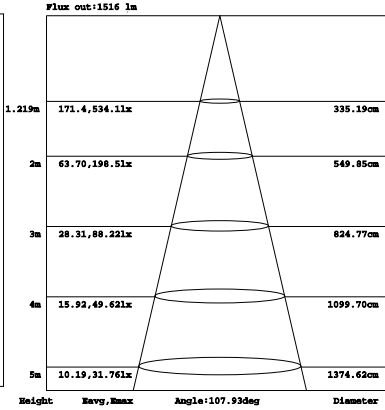
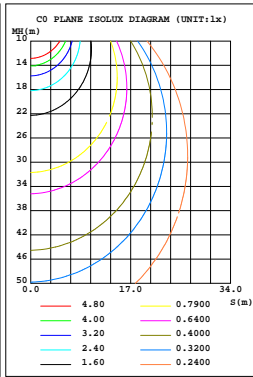
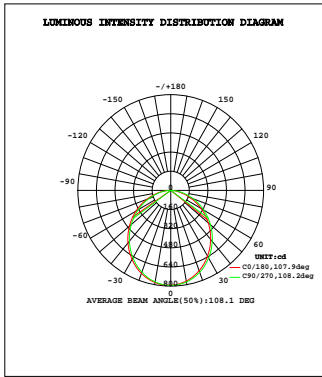

WSD-SDW101520W347-345K-W (20W&4000K)

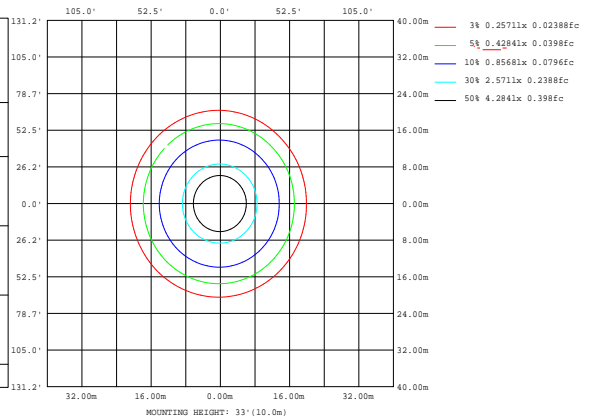
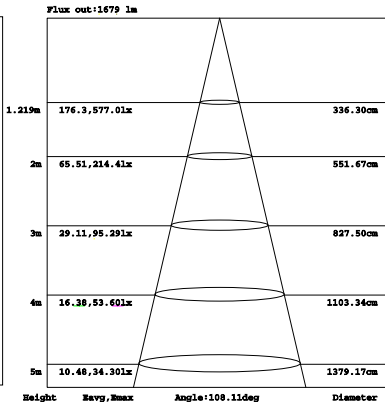
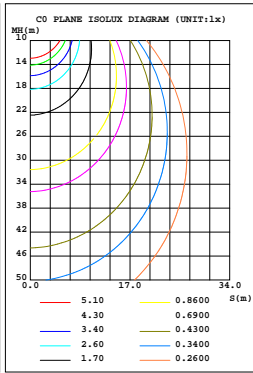
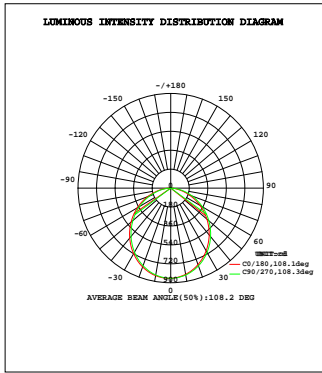

WSD-SDW101520W347-345K-W (20W&5000K)

