

**exec**<sup>TM</sup>



**nuna**<sup>®</sup>

# Thank you!

You've just purchased a Nuna product, and you can be sure that your child is getting the best there is. Our products are expertly engineered for safety, with luxury fabrics and sophisticated style.

Whatever made you fall in love with Nuna, rest assured your adventures with your little one will be easier from now on, freeing you to enjoy more happy family moments together.

## Easy Installation

Our products are designed to make your life easier, so installing this child restraint doesn't require outside assistance. While we encourage the use of Certified Child Passenger Safety Technicians to ensure you have installed the seat correctly, you can install the child restraint in your vehicle without these professionals by carefully reading and following these instructions.



**IMPORTANT!**  
**KEEP THESE**  
**INSTRUCTIONS FOR**  
**FUTURE REFERENCE:**  
*READ CAREFULLY*

**⚠ WARNING:** Read and understand **ALL** warning labels affixed to the child restraint and all written instructions. Failure to do so can result in serious injury or death. Store instructions in the slot on the bottom of the leg rest for future use.

## Contents

### Important Information

Product Information/Registration	4
Child Usage Requirements	6
Safety Warnings	8
Vehicle Compatibility	12
Car Seat Use after a Crash	18
Aircraft Installation	18

### Child Restraint Overview

Parts List	19–21
Features Usage	22

### Rear Facing Installation

42

### Forward Facing Installation

50

### Booster Installation

58

### Securing Child

With Built-in Harness	66
Without Built-in Harness	68

### Cleaning and Maintenance

70

# Product Information/ Registration

Model Number: \_\_\_\_\_

Manufactured in (date): \_\_\_\_\_

## Product Registration

Please fill in the above information. The model number and the manufactured in date are located on a label on the bottom of your child restraint. Fill out the prepaid registration postcard attached to the seat cover and mail it today.

Child restraints could be recalled for safety reasons. You must register this restraint to be reached in a recall. Send your name, address, e-mail address if available and the restraint's model number and manufacturing date to:

Nuna Baby Essentials Inc.  
70 Thousand Oaks Blvd.  
Morgantown, PA 19543

or call 1.855.NUNA.USA

## Recall Information

For recall information, call the U.S. Government's Vehicle Safety Hotline at: 1.888.327.4236 (TTY: 1.800.424.9153) or go to <http://www.NHTSA.gov>

## Warranty

We have purposely designed our high-quality products so that they can grow with both your child and your family. Because we stand by our product, our gear is covered by a custom warranty per product, starting from the day it was purchased. Please have the proof of purchase, model number and manufactured in date available when you contact us.

**For warranty information please visit:**  
[www.nunababy.com/usa/warranty](http://www.nunababy.com/usa/warranty)

## Contact

For replacement parts, service, or additional warranty questions, please contact our customer service department.

**In the USA:**  
[infousa@nunababy.com](mailto:infousa@nunababy.com)  
[www.nunababy.com](http://www.nunababy.com)  
1.855.NUNA.USA

# Child Usage Requirements

To use this child restraint, your child must meet **BOTH** the weight and height requirements below:

**Weight:** 5–120 lb (2.3–54 kg)

**Height:** 57 in. (145 cm) or less

The infant insert (p.24) is for use with infants who weigh between 5–11 lb (2.3–5 kg). **DO NOT** use the insert for a child who weighs more than 11 lb.

In **booster** mode, child must be able to sit relatively still in the same position with the shoulder and lap belt properly positioned on their body throughout the car ride.

## Which mode is best for my child?

Consult the chart on the next page to determine the proper mode based on your child's weight/height. Throughout these instructions and on the product labels, the three modes are identified by color as indicated below.

### Instruction Color Key

 Rear facing       Forward facing       Booster

## American Academy of Pediatrics Recommendation

The AAP recommends children should ride **rear facing for as long as possible**, until they reach the maximum weight or height allowed by their seat.

For this seat, that maximum is 50 lb (22.6 kg) or 49 in. (124 cm).

	MODE & installation	WEIGHT (pounds)	MAX. HEIGHT (inches)
 <b>DO NOT</b> install using <b>BOTH</b> the vehicle belt and lower anchor belt/LATCH.	<b>Rear Facing</b> with vehicle belt with lower anchor belt	50 5 5 5	49 (124 cm) 57 (145 cm)
	<b>Forward Facing</b> with vehicle belt & tether with lower anchor belt & tether	65 25 25 40	57 (145 cm)
Secure the booster even when it is <b>unoccupied</b> .	<b>Booster</b> with lower anchor belt	120 5 lb 2.3 kg 11 lb 5 kg 25 lb 11.3 kg 35 lb 15.8 kg 40 lb 18.1 kg 50 lb 22.6 kg 65 lb 29.4 kg 120 lb 54 kg	57 (145 cm)

# **⚠️ WARNING**

**DEATH OR SERIOUS INJURY CAN OCCUR,**

## **General Warnings**

### *Child Restraint Use*

When used with built-in harness, use **ONLY** with children who weigh 5–65 lb (2.3–29.4 kg) and whose height is 49 inches (124 cm) or less.

When used without built-in harness as a belt positioning booster, use **ONLY** with children who weigh between 40–120 lb (18–54 kg) and whose height is 38 to 57 inches (96 to 145 cm).

**DO NOT** use in any configuration not shown in the instructions. Please refer to vehicle owner’s manual for recommended or suggested installation positions.

**DO NOT** use the child restraint if it is more than 10 years old. Check the label or stamped “do not use after” date on the bottom of the child restraint.

**DO NOT** use another manufacturer’s cover, padding, fabric, or other soft materials with this child restraint, as these constitute an integral part of the child restraint performance.

**DO NOT** modify your child restraint or use any accessories or parts supplied by other manufacturers unless they are approved by Nuna for use with this child restraint. Doing so may be unsafe and may void the warranty.

**DO NOT** use a cut, frayed or damaged vehicle seat belt. **NEVER** use the child restraint if it has frayed or cut harness straps, any damaged or missing parts, or has been in a damaging crash. To find out if damaged parts are replaceable, call 1-855-NUNA-USA.

**NEVER** use a car seat that has been involved in a moderate to severe crash. **See page 18** to learn the difference between a minor and moderate to severe crash.

### *Child Restraint Safety*

**DO NOT** allow anyone who has not read the instructions to install or use this child restraint. **NEVER** give this child restraint to another person without also giving them these instructions.

**NEVER** leave child unattended in this child restraint.

To avoid strangulation, do not allow children to play with vehicle or child restraint belts or straps. If possible, move unused belts out of reach.

Cover the child restraint when your vehicle is parked in sunlight. Parts of a child restraint can become very hot if left in the sun, and can burn a child's skin. Check for hot parts before putting your child in the child restraint.

**NEVER** leave child restraint unsecured in your vehicle even when it is unoccupied. In a crash, it could become a projectile and injure other vehicle occupants.

**NEVER** leave luggage or other objects unsecured in a vehicle, as they are liable to cause injuries in the event of a collision.

## **Additional Booster Warnings**

### *Booster Installation*

**DO NOT** install on a rear facing or side facing vehicle seat.

This booster should be installed in the rear vehicle seat so that it can be installed with the vehicle lower anchors.

**DO NOT** install in the front passenger seat with an active airbag, unless the air bag can be turned OFF.

The child restraint is **NOT** certified for aircraft use when used as a booster. Aircraft belts are lap belts only, and a child cannot be secured in the booster with only a lap belt.

### *Vehicle Belt Positioning*

**WARNING!** Use **ONLY** the vehicle's lap and shoulder belt system when restraining the child in this booster seat. Use of any other method of securement will not properly secure the child, which could result in serious injury or death. **DO NOT** use the built-in harness when using the booster seat.

Properly position the vehicle lap and shoulder belt on your child. Make sure the vehicle lap and shoulder belt are not loose. A loose or improperly positioned vehicle lap and shoulder belt could cause the child to be ejected in a sudden stop, turn or crash and cause serious injury or death.

The vehicle shoulder belt should rest on the child's shoulder and across the center of the chest.

The vehicle lap belt must remain snug across the child's thighs.

# Vehicle Compatibility

**⚠ WARNING:** You **MUST** read and understand **ALL** child restraint related instructions and warnings in your vehicle owner's manual to correctly and safely use this child restraint in your vehicle.

This child restraint can **ONLY** be installed on vehicle seats that face forward. **DO NOT** install in seats that face to the sides or rear of the vehicle.

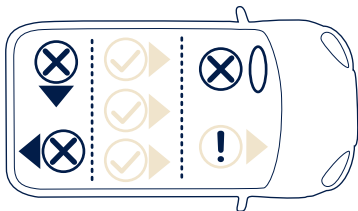

**⚠ WARNING: SERIOUS INJURY OR DEATH MAY OCCUR.** **NEVER** install this child restraint rear facing in a vehicle seating position with a frontal air bag unless it is turned off. If your vehicle is equipped with front passenger air bags, check your vehicle owner's manual for child restraint installation instructions.

**IMPORTANT:** According to accident statistics, children are safer when properly restrained in the rear seating positions than in the front seating positions.

## Using LATCH

**LATCH** (Lower Anchors and Tether for **CH**ildren) is a system for installing a child restraint in a vehicle without using the vehicle belts. This child restraint can be installed without vehicle belts by connecting the child restraint's lower anchor belt to the lower anchorages in your vehicle.

Refer to your vehicle owner's manual to determine if your vehicle is equipped with **LATCH**, and how to correctly use **LATCH** to install this child restraint in your vehicle.

**LATCH** use is based on mode, as specified below:

- R** **B** Lower anchors only
- F** Lower anchors and tether

**R** Rear facing   **F** Forward facing   **B** Booster

## LATCH Location

Common locations of **LATCH** in a vehicle are shown below (consult your vehicle owner's manual). Other locations of the tether are shown on the next page.

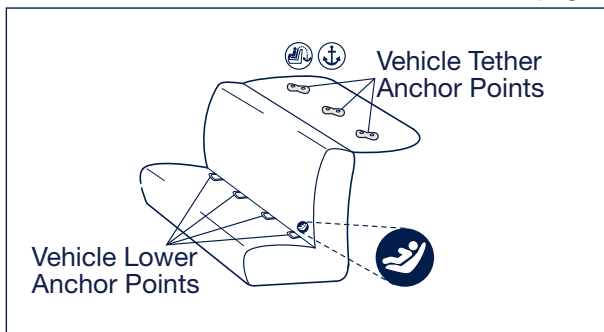



## LATCH with Built-in Harness

When installed rear facing or forward facing, this child restraint is designed to be used with lower **LATCH** anchors at the standard spacing of 11 inches (28 cm). **LATCH** lower vehicle anchor points are defined as 11 inches (28 cm) from the center of one **LATCH** anchor to the center of another **LATCH** anchor.

**⚠ WARNING: DO NOT USE** the **LATCH** lower anchor belt to attach this child restraint rear facing when restraining a child weighing over 35 lb (15.8 kg) or forward facing with built-in harness when restraining a child weighing over 40 lb (18.1 kg). Check your vehicle owner's manual for tether anchor weight limits (use tether forward facing **ONLY**).

## Tether

The child restraint's tether strap should be used for **ALL** forward facing installations (except booster mode) as it provides a more secure installation and is proven to be safer. In a crash, the tether limits a child's forward movement, protecting their head and neck and reducing the risk of injury.

Common locations (consult your vehicle manual):

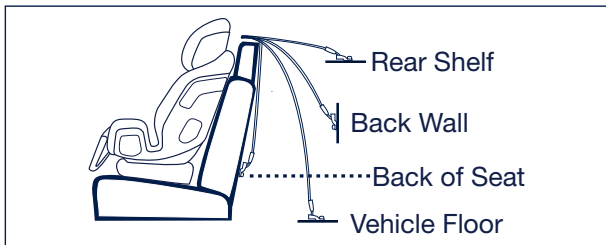

## LATCH without Built-in Harness (Booster)

Non-standard spacing of the lower anchors is allowed in booster mode **ONLY IF** the vehicle manufacturer allows it; consult your vehicle owner's manual.

An example of non-standard spacing is installing the booster in the center seating position of your vehicle where there are no lower anchors and using the closest lower anchors from the outboard positions instead.

When using non-standard spacing, lower anchors **MUST NOT** interfere with the vehicle seat belt.

**DO NOT** use tether in booster mode.

## Using Vehicle Belts

Vehicle belt type is based on mode, as specified below:

- R** **F** **B** Lap/Shoulder Belt (A)
- R** **F** Lap Belt Only (B)

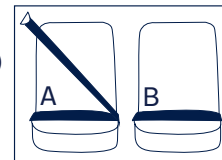

**⚠ Belts MUST** be able to be locked. Refer to your vehicle owner's manual to determine if the belts in your vehicle lock by: A) switching the seat belt's retractor by pulling the belt all the way out, or B) a locking latch plate that locks the vehicle's seat belts so they will not move freely.

If the belt cannot be locked using one of these methods, contact Nuna Customer Service for a locking clip.

## Vehicle Belts that CANNOT Be Used

The following types of vehicle belts **MUST NOT** be used to install this child restraint. They will not provide a secure, safe installation. Refer to your vehicle owner's manual for which seating positions in your vehicle can be used to install this child restraint using vehicle belts or **LATCH**.

**⚠** In booster mode, child must be secured by a lap/shoulder belt, **NEVER** a lap belt only.

### 1 - Motorized Belts (Automatic)

These should not be used unless the shoulder belt can be removed, the lap belt is locked and use is allowed by the vehicle manufacturer.

### 2 - Dual Retractor Lap/Shoulder Belts

If allowed by the vehicle manufacturer, the lap belt only may be used to secure the child restraint if it can be locked in accordance with this manual and the vehicle's manual.

### 3 - Non-Locking (ELR) Lap Belts

This belt locks only in a crash or sudden stop and should only be used with a belt shortening clip. Contact your vehicle manufacturer if needed.

### 4 - Airbag/Inflatable Belts

This belt is only allowable in booster mode.

### 5 - Door Mounted Belts

### 6 - Lap Belts forward of Seat Bight (where the seat bottom and back meet)

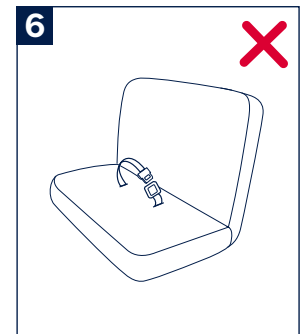
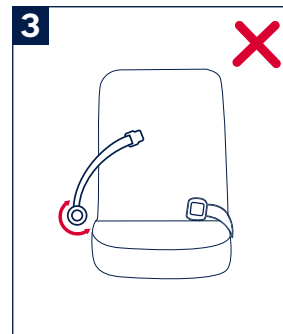
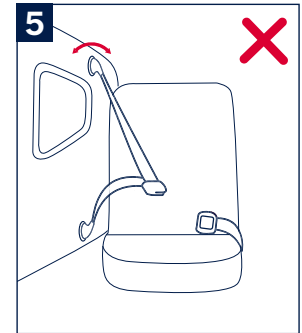
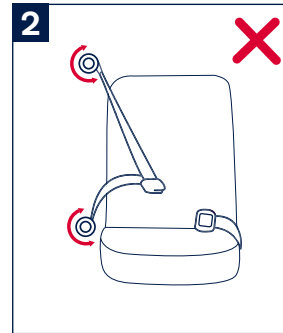
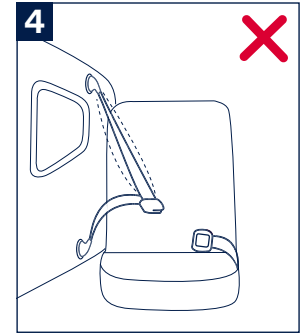
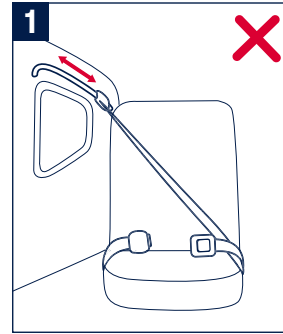

## Car Seat Use after a Crash

The National Highway Traffic Safety Administration (NHTSA) recommends that car seats be replaced following a moderate or severe crash. Car seats do not automatically need to be replaced following a minor crash.

A minor crash is one in which **ALL** of these apply:

- The vehicle was able to be driven away from the crash site.
- The vehicle door nearest to the car seat was not damaged.
- None of the passengers in the vehicle sustained any injuries in the crash.
- If the vehicle has air bags, none of the air bags deployed during the crash; and
- There is no visible damage to the car seat.

Any crash that does not meet all of the above criteria for a minor crash is considered a moderate to severe crash. **NEVER** use a car seat that has been involved in a moderate to severe crash.

*Information from nhtsa.gov*

## Aircraft Installation

The FAA recommends that children up to 40 lb (18.1 kg) use a child restraint while traveling on an aircraft. **When used with the harness system:** This restraint is certified for use in aircraft. **When used without the harness system as a belt-positioning booster:** This restraint is **NOT** certified for use in aircraft, since aircraft belts are lap belts only. **Contact your airline about their policies prior to travel.**

Install child restraint **rear** or **forward facing** in a forward facing aircraft seat following Vehicle Lap Belt instructions (p.48 or p.56), but install aircraft belt **on top** of closed True Tension™ door, under seat cover.

## Parts List

### Front View

- |   |                           |    |                          |
|---|---------------------------|----|--------------------------|
| 1 | Head Support Button       | 10 | Harness Release Button   |
| 2 | Head Support              | 11 | Harness Adjustment Strap |
| 3 | Head Insert               | 12 | Seat Cover               |
| 4 | Shoulder Harness Pad (x2) | 13 | Harness Buckle           |
| 5 | Infant Insert             | 14 | Cup Holder (x2)          |
| 6 | Hip Harness Pad (x2)      | 15 | Harness Strap            |
| 7 | Crotch Pad                | 16 | Chest Clip               |
| 8 | Leg Rest Button           | 17 | Slip Cover               |
| 9 | Leg Rest                  | 18 | Slip Cover Snap          |

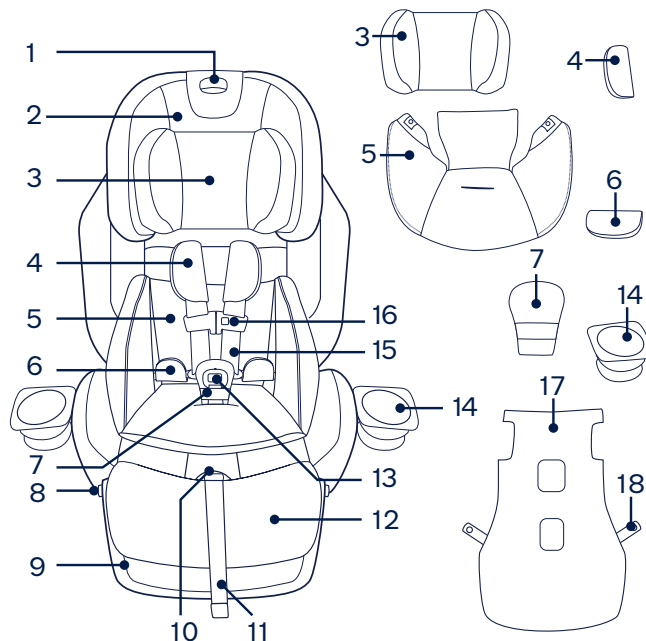

### Interior View

- 19 Harness Storage Compartment
- 20 Forward Facing True Tension™ Door
- 21 Forward Facing True Tension™ Door Release Button
- 22 Lower Anchor Attachment Strap
- 23 Rear Facing True Tension™ Door Release Button
- 24 Rear Facing True Tension™ Door
- 25 Lower Anchor and Harness Buckle Storage Compartment (under Rear Facing True Tension™ Door)

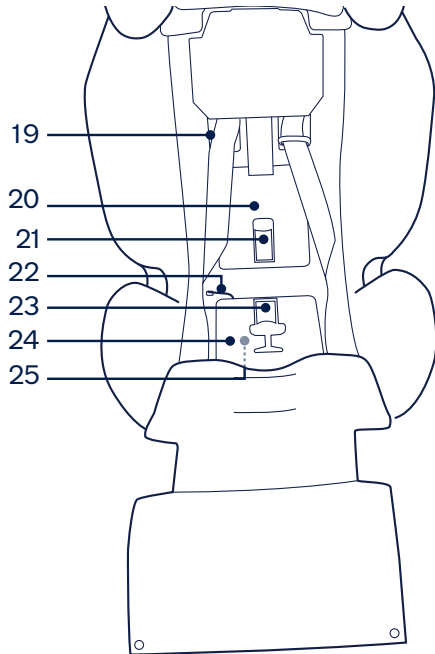

### Side View

- 26 Booster Shoulder Belt Guide
- 27 Side Impact Protection Pod
- 28 Forward Facing Belt Path
- 29 Magnetic Buckle Tongue Holder
- 30 Booster Lap Belt Path
- 31 Recline Position Indicator
- 32 Recline Button
- 33 Rear Facing Belt Path (under Cup Holder)
- 34 Instruction Storage

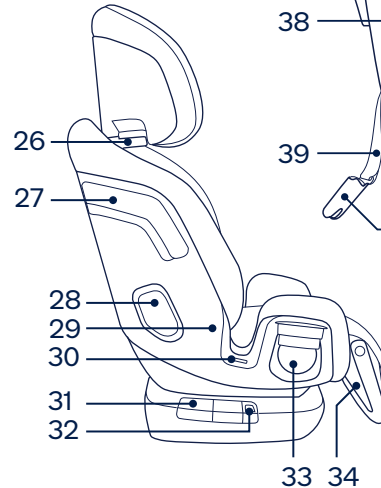

### Back View

- 35 Tether Strap Cover
- 36 Tether Strap
- 37 Tether Strap Adjuster
- 38 Tether Hook
- 39 Lower Anchor Belt
- 40 Lower Anchor Connectors
- 41 Lower Anchor Adjuster

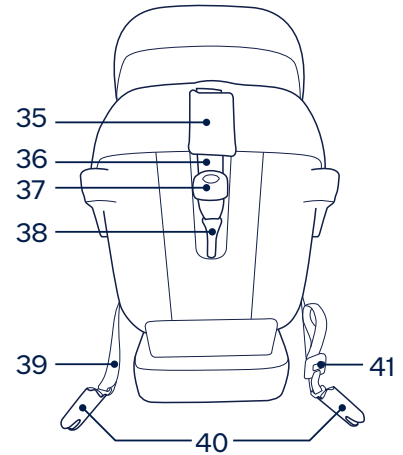

# Features Usage

## Harness Use

### 1 - To Loosen Harness

Press on harness release button (1) while pulling forward on the harness straps (2).

### 2 - To Open Chest Clip

Press button on front of clip (1) and pull clip apart (2).

### 3 - To Open Harness Buckle

Press red button on front of buckle (1) and pull out buckle tongues (2).

### 4 - To Use Magnetic Buckle Tongue Holders

Loosen and unbuckle harness. Place the buckle tongues against the magnetic area on the side of the child restraint so that the tongues are held in place.

### 5 - To Fasten Chest Clip

Push chest clip halves together until they click. (1) Pull to check.

### To Fasten Buckle

Insert buckle tongues firmly into buckle until they click. (2) Pull up on tongues to ensure they are locked.

### 6 - To Tighten Harness

Pull on harness adjustment strap. (1) Place chest clip at child's armpit level after tightening. (2)

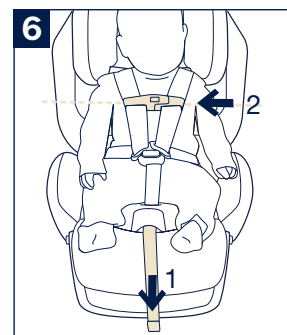
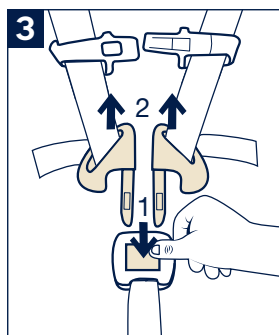
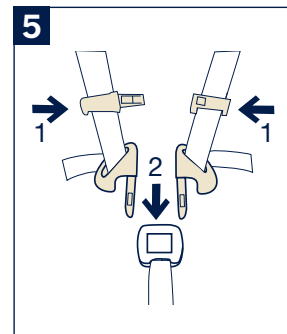
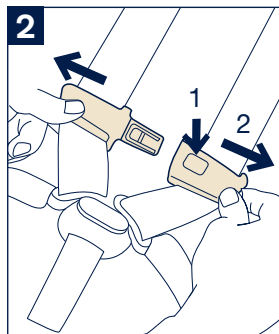
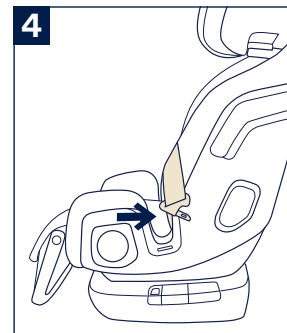
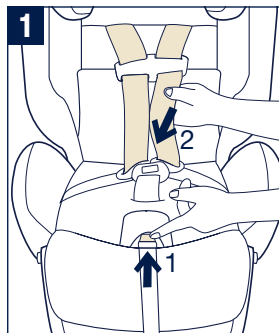

## Head Insert Use

- 1 - The head insert may be used or removed for improved comfort or fit of any child. To use, attach the snaps on the head insert to the snaps on the head support.
- 2 - When the head insert is not in use, tuck the snaps on the head support behind the head support fabric.

## Infant Insert Use

The infant insert **MUST** be used for a child weighing between 5–11 lb and must **NOT** be used otherwise. The insert can improve the harness fit and recline angle for smaller infants.

When rear facing, the harness **MUST** be positioned **AT** or **JUST BELOW** the child's shoulders. If the harness straps are positioned **ABOVE** the child's shoulders, use the infant insert to adjust the fit.

- 3 - Pull harness buckle up through slot in bottom of insert.
- 4 - Route harness straps through sides of insert.
- 5 - Attach snaps on insert to keep harness straps in place.
- 6 - Push insert firmly into child restraint.

When properly installed, the infant insert will not interfere with harness straps or harness buckle. Harness buckle must be used in **inner position** when infant insert is used (p.28).

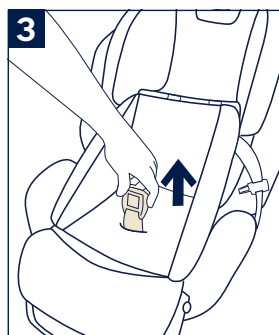
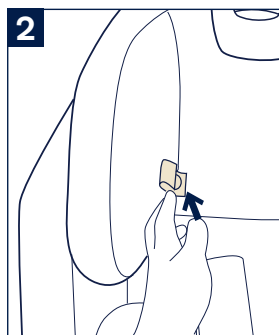
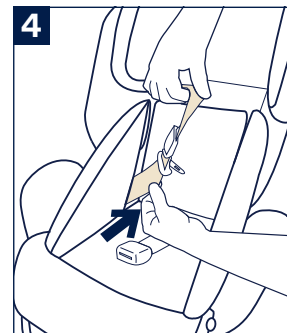
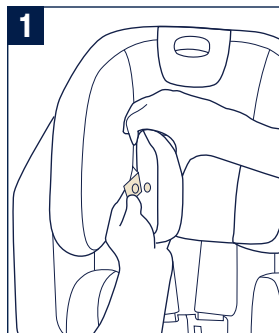

## Slip Cover Use

The slip cover can be used to keep the seat cover clean. It can easily be removed and washed.

Unbutton the seat cover.

- 1 - Slide the bottom of the slip cover over the leg rest.
- 2 - Unbutton the seat cover and slide it through the two straps on the back of the slip cover until the bottom strap lines up with the bottom of the seat cover. Button the seat cover back into place.
- 3 - Attach the snaps on the sides of the slip cover to the bottom of the slip cover to secure it over the leg rest.
- 4 - Route the harness adjustment strap and harness buckle through the holes in the slip cover.

To remove the slip cover, reverse these steps.

## Shoulder, Hip, and Crotch Pad Use

- 5 - **⚠ ALWAYS** use the shoulder, hip, and crotch pads in rear facing mode.

In forward facing mode, the pads are a comfort feature that may be used or removed for any child.

To use the shoulder and hip pads, fold each pad in half over the harness strap and attach the snaps.

To use the crotch pad, slide the harness buckle through the loop on the pad.

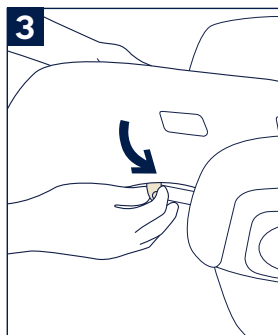
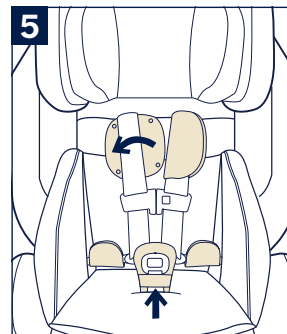
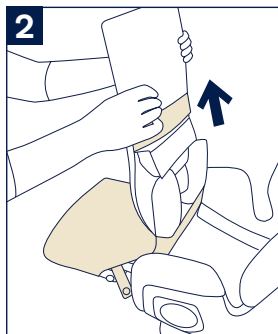
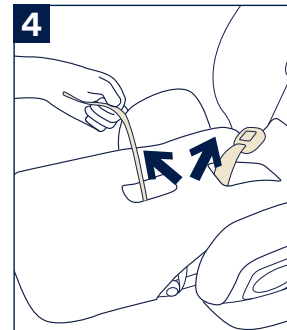
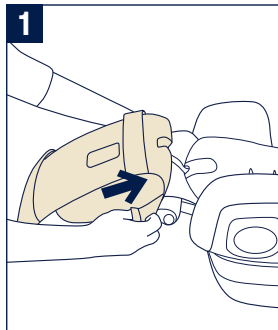

## Harness Buckle Adjustment

The harness buckle has two positions. Use the position that is closest to (but not under) your child.

Remove infant insert (p.24) and loosen and unbuckle harness (p.22).

- 1 - Unsnap seat cover (1) and pull forward while pulling harness buckle backwards through slot in seat cover (2).
- 2 - Route harness buckle strap through either slot (1 or 2) on the rear facing True Tension™ door. Pull buckle through corresponding slot in seat cover and replace seat cover and inserts (if using).

## Cup Holder Use

- 3 - Pivot cup holder up and lock in use position.
- 4 - Push center of cup holder down to extend to opened position.
- 5 - While in the opened position, pull up on the cup holder to remove for washing.
- 6 - To store, collapse cup holder and pivot down. Press to lock in position.

Cup holders **MUST** be opened to access belt path during rear facing installation of child restraint. Cup holders may be collapsed down against vehicle belt after belt installation.

**DO NOT** place glass or metal containers or hard or sharp objects in cup holder. In a crash they could cause serious injury.

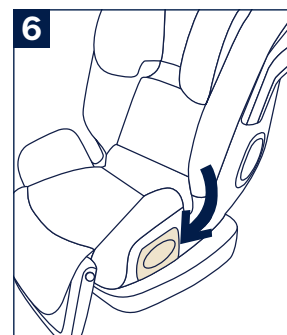
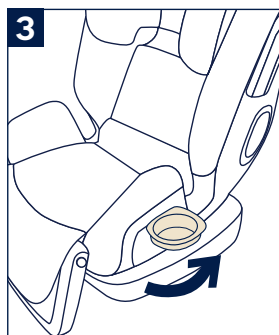
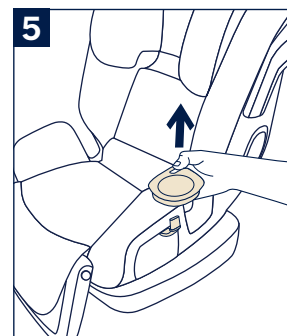
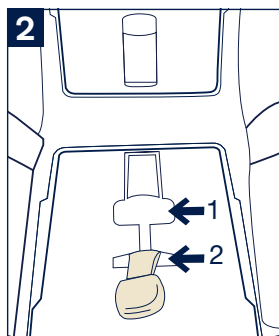
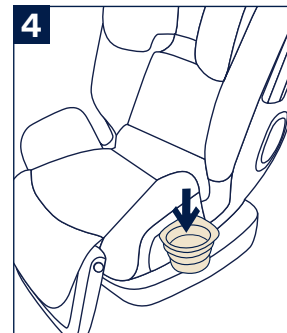
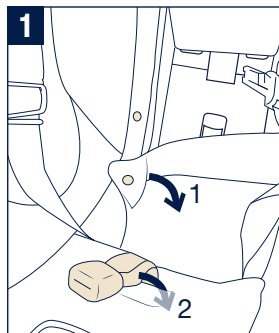



## Head Support Adjustment

There are 12 head support positions.

- 1 - With harness loose (p.22), squeeze head support button and move head support up or down to desired position.

Release head support button and slide head support slightly up or down until locked into position. The head support will click when it locks.

**CHECK** that head support is locked on both sides by pulling firmly up and down.

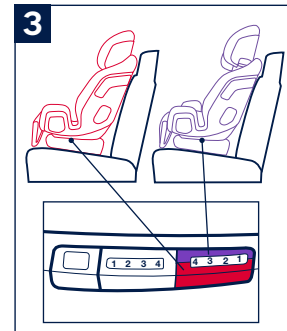

## Recline Use

There are 8 recline positions.

- 2 - Positions 1-4 (BLUE) are for rear facing use with children 5-50 lb (2.3-22.6 kg).

If infant's head falls forward, child restraint must be reclined more. Use infant insert with infants 5-11 lb (2.3-5 kg) to improve recline angle.

- 3 - Positions 1-4 (RED/PURPLE) are for forward facing use with children 25-65 lb (11.3-29.4 kg), and for booster use with children 40-120 lb (18-54 kg).
- 4 - Press recline button (1) on either side of the child restraint and tilt seat to desired recline position (2).

Release recline button, and check that child restraint is locked in desired recline position.

To change recline position after installation, you **MUST** uninstall child restraint, select new recline position, and then reinstall child restraint.

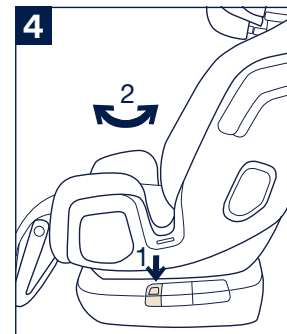
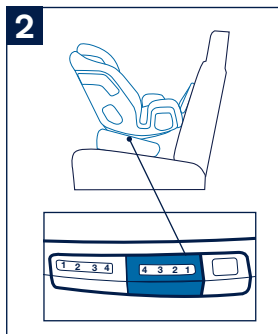

## Leg Rest Use

The fully adjustable leg rest can be used in all three modes of the child restraint, and it serves as both a safety and a comfort feature. The leg rest can be angled to achieve proper leg support and extended for longer legs.

### Rear Facing

In this mode, the leg rest not only provides increased leg room, but also serves as an anti-rebound panel, which aids in achieving proper installation tightness.

- 1 - **⚠** In rear facing mode, the leg rest **MUST** be in the upright position. The angle of the leg rest should match the angle of the vehicle seat back.

### Forward Facing or as a Booster

In these modes, the leg rest provides leg support and protects your vehicle seat from dirty shoes.

- 2 - **⚠** In these modes, the leg rest **MUST NOT** be above the restraint seating surface.

### To Adjust Leg Rest:

- 3 - Push and hold the buttons on both sides of the leg rest. You can now angle and extend the leg rest simultaneously.
- 4 - Adjust the leg rest to the desired position by tilting to rotate the angle (1) and pulling forward to extend for a child with longer legs (2).

Once you reach the desired position, release the buttons. You will hear them click as they spring back into place, locking the leg rest.

If the buttons do not spring back right away, gently tilt the leg rest until it locks into place. Angle must be locked before extension can be locked.

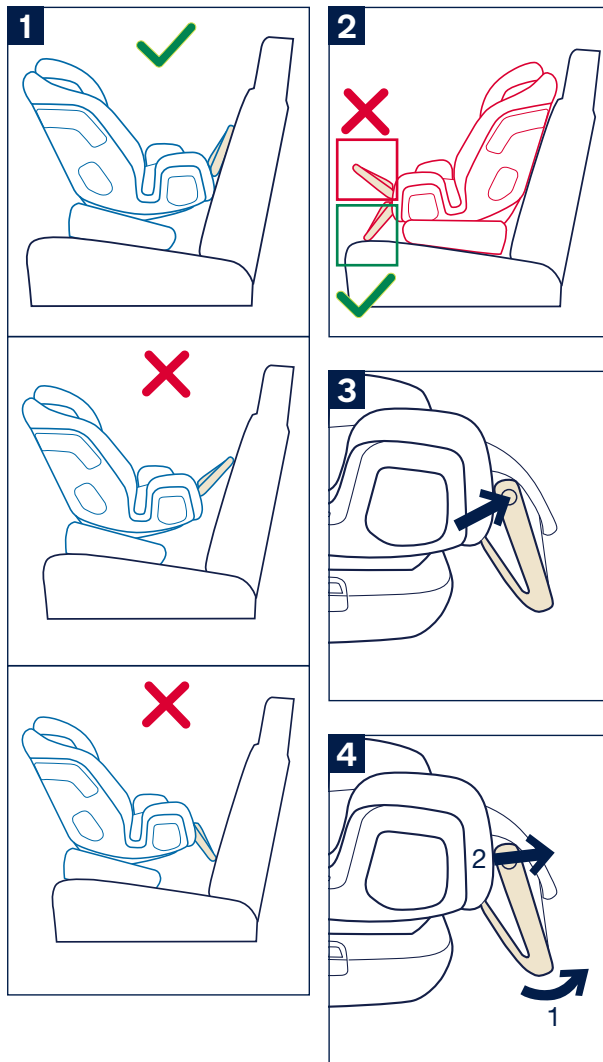

## True Tension™ Door Use

This child restraint has two True Tension™ doors that aid in a simple and secure installation of the child restraint in your vehicle. They are located underneath the seat cover. The upper door (RED) is for forward facing and booster use, and the lower door (BLUE) is for rear facing use.

Remove infant insert, loosen and unbuckle harness, and retain with magnetic buckle tongue holders (p.22).

- 1 - Adjust head support to highest position, unsnap seat cover and pull to front of seat.
- 2 - Lift door release button for the appropriate True Tension™ door.
- 3 - Lift open True Tension™ door. Follow instructions for belt routing: [Rear facing](#), p.42, [Forward facing](#), p.50, [Booster](#), p.58
- 4 - Close True Tension™ door by pressing down firmly on door until it latches in place. Replace seat cover and inserts (if used) (p.24).

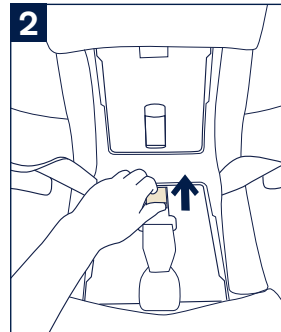
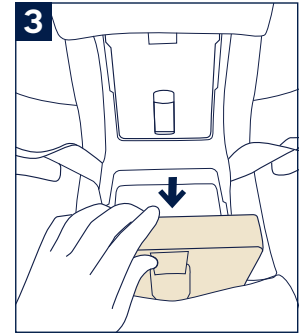
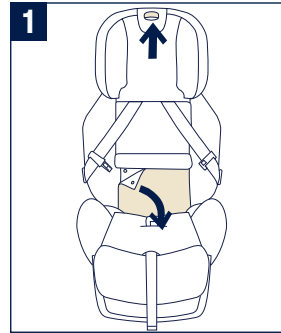

## Lower Anchor Use

The lower anchor belt can be used instead of a vehicle belt to install this child restraint. The lower anchor belt **MUST NOT** be used **rear facing** if your child weighs more than 35 lb (15.8 kg), or **forward facing** if your child weighs more than 40 lb (18.1 kg).

The lower anchor belt can and **SHOULD** be used with the **booster** from 40–120 lb (18–54 kg).

The lower anchor belt and connectors are stored under the rear facing True Tension™ door.

Remove infant insert, loosen and unbuckle harness (p.22), and unsnap seat cover.

- 1 - Lift rear facing True Tension™ door release button.
- 2 - Take out the lower anchor belt and connectors.
- 3 - Lengthen lower anchor belt for use by pressing adjuster button while pulling on belt.
- 4 - For belt routing, see p.46, p.54, or p.62. To connect lower anchor belt to lower anchors in vehicle, press connector firmly onto lower anchor and pull to check. Lower anchor belt **MUST NOT** interfere with the vehicle seat belt.
- 5 - Remove all slack from lower anchor belt by pulling loop at end of belt.
- 6 - To release lower anchor belt, press red button on end of connector while pulling on belt.

Store lower anchors when not in use. Place one lower anchor connector in each half of the storage compartment. Fold excess belt webbing into compartment. Belt **MUST NOT** interfere with latching of True Tension™ door.

**⚠ DO NOT** cut the lower anchor attachment strap. It permanently secures the lower anchors to the child restraint.

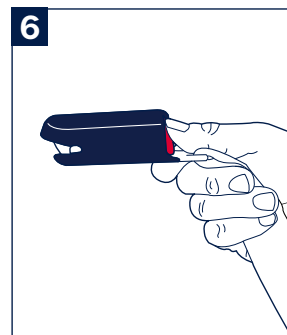
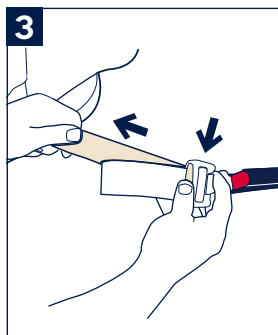
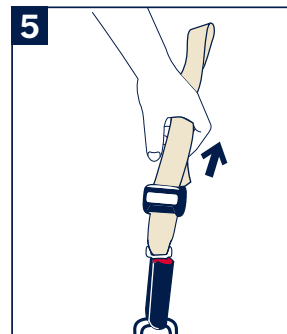
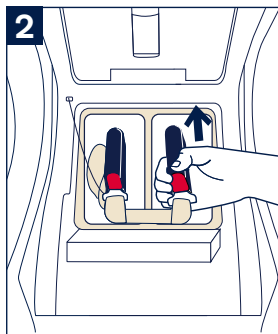
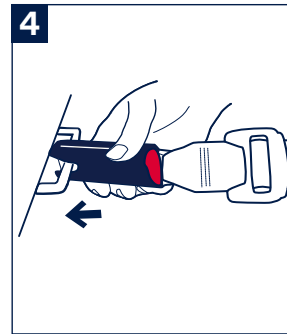
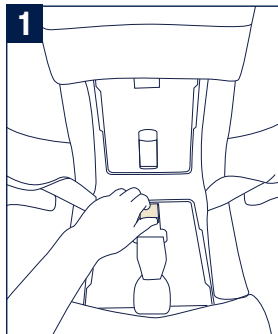

## Tether Use

- 1 - Open the tether strap cover by undoing the hook and loop (1). Unclip the tether hook (2) by pushing in the back of the hook while pulling the hook down and off of the anchor.
- 2 - To extend tether for use, tilt tether adjuster and pull to lengthen.
- 3 - Locate the tether anchor in your vehicle. Look for the tether icon pictured here. Attach the tether hook to the vehicle tether anchor (1). Once tether is anchored, tighten by pulling on tether strap to remove all slack (2).

Close the tether strap cover by attaching the hook and loop.

- 4 - **⚠** When attaching the tether hook to the vehicle tether anchor, route the tether strap over the top of the closed tether strap cover, not out of the bottom.
- 5 - To store, attach tether hook to the back of the child restraint (1) and remove slack from tether strap. Loose strap should then be rolled neatly and stored under tether cover (2). When not in use, tether **MUST** be properly stored.

### **⚠ WARNING: ALWAYS USE TETHER**

for forward facing installation if vehicle is equipped with a tether anchor point and vehicle requirements are met (see vehicle owner's manual). **NEVER** use tether in rear facing or booster installation.

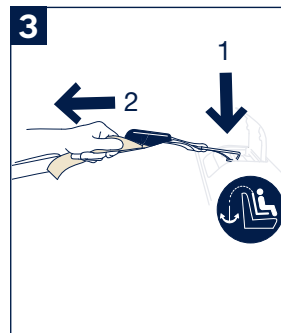
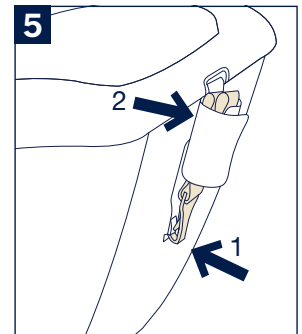
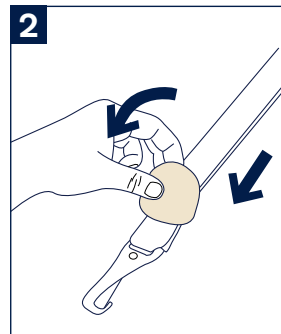
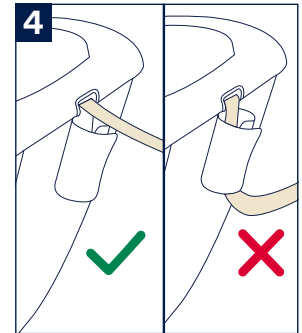
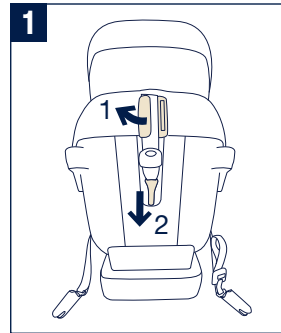

## Harness Storage

**⚠ ALWAYS** store the harness when using the child restraint as a booster.

- 1 - Loosen harness, open chest clip, and open harness buckle.  
Fully raise head support (p.30) **(1)**. Unsnap and lift the upper and lower seat covers **(2)**.
- 2 - Gently slide each harness strap under the harness storage compartment cover **(1)**. **DO NOT FORCE OR BEND** the compartment cover.  
Store chest clip and buckle tongues inside harness storage compartment **(2)**.
- 3 - Slide harness buckle through slot in rear facing True Tension™ door.
- 4 - Store harness buckle in lower anchor storage compartment. Replace seat cover.

## Shoulder Belt Guide Use

When securing child in booster, the vehicle shoulder belt **MUST** be routed through the shoulder belt guide.

- 5 - Pull the shoulder belt guide back **(1)** and slip the vehicle shoulder belt in front of the open shoulder belt guide **(2)**.
- 6 - Release the shoulder belt guide.

**⚠** The vehicle shoulder belt must route **COMPLETELY** through the shoulder belt guide and across the center of the child's chest, and must not fall off the child's shoulder.

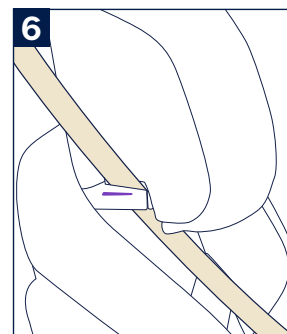
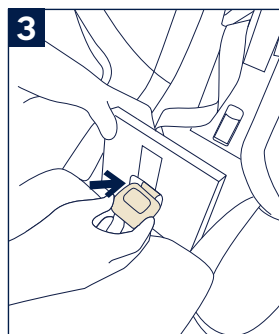
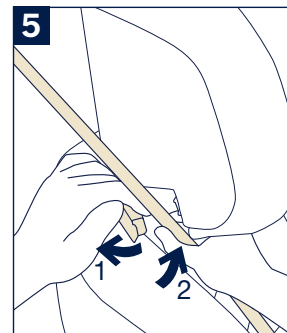
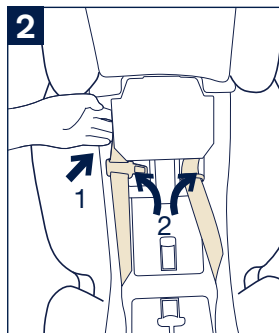
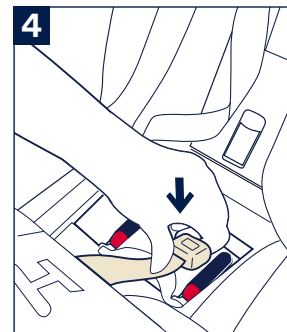
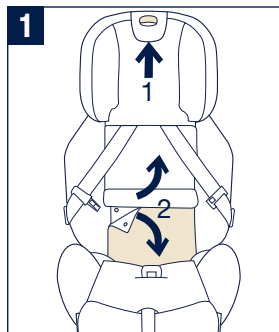

# Rear Facing Installation

Birth to 2+ years old, 5–50 lb (2.3-22.6 kg),

49 in. (124 cm) or less

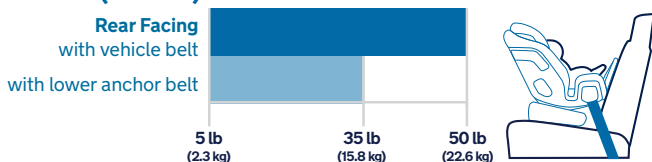

**⚠ ALWAYS** use the shoulder, hip, and crotch pads in rear facing mode. Use infant insert with infants 5–11 lb (2.3–5 kg) to improve the recline angle for smaller infants.

## Rear Facing Setup

Store tether strap under tether strap cover.

- 1 - Select rear facing recline position 1–4 (BLUE) (p.30).
- 2 - Place child restraint rear facing in a compatible vehicle seat (p.12).
- 3 - Move leg rest to required installation position (p.32). The leg rest **MUST** be used in rear facing mode. The angle of the leg rest should match the angle of the vehicle seat back.

In Lap Belt Only installation (p.48), the leg rest **CANNOT** be extended.

- 4 - Raise cup holders to access rear facing belt path.

Loosen and unbuckle harness and retain with magnetic buckle tongue holders (p.22). Remove infant insert and lift lower seat cover.

- 5 - Open rear facing True Tension™ door (p.34).

Complete installation using your vehicle's lap/shoulder belt (p.44), the lower anchor belt (p.46), or a compatible vehicle lap belt (p.48).

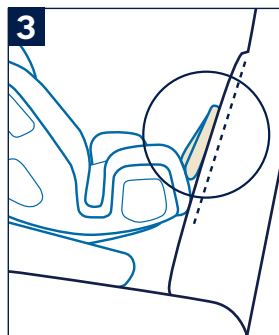
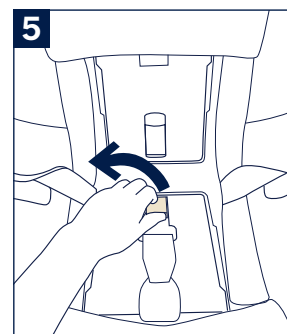
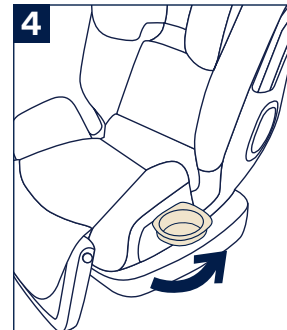
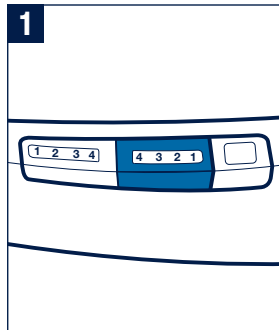

**⚠ WARNING: DO NOT** install with **both** the vehicle seat belt and lower anchor belt.

## Using Vehicle Lap/Shoulder Belt

(preferred installation method)

- 1 - Route vehicle lap/shoulder belt through **BLUE** rear facing belt path and buckle vehicle lap/shoulder belt. Vehicle belt **MUST** be routed under True Tension™ door (1).

Remove all slack from the vehicle belt (2).

- 2 - Close True Tension™ door and lock vehicle belt (refer to vehicle owner's manual). Test by pulling on shoulder belt to ensure it is locked.

Replace seat cover and infant insert (if used).

To open True Tension™ door, unbuckle vehicle belt and lift door release button.

**⚠ WARNING:** Check that child restraint is securely installed before each use.

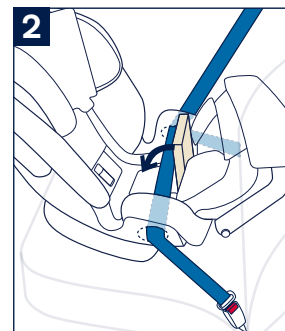
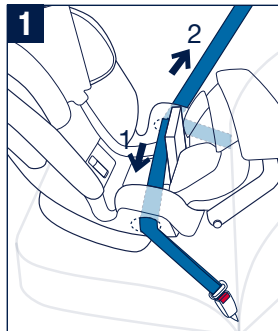

### Check Installation

- Seat is in rear facing recline position.
- Leg rest is locked and making contact with the vehicle seat, positioned at the same angle as the vehicle seat back.
- Seat is securely installed. Hold seat near rear-facing belt path and move seat in all directions. Seat should move less than 1 inch.
- Tether strap is not used for rear facing installation and must be secured in storage location on back of child restraint.
- Cup holders may be placed in any position after installation.



## Using Lower Anchor Belt

**⚠ WARNING:** Do not install by this method for a child weighing more than 35 lb (15.8 kg).

- 1 - Remove lower anchor belt from storage compartment (p.36) and route through **BLUE** rear facing belt path under cup holder. Belt **MUST** be routed under True Tension™ door.
- 2 - Lengthen lower anchor belt as necessary and attach to lower anchor points in vehicle.
- 3 - Remove all slack from lower anchor belt by pulling loop at end of belt.
- 4 - Close True Tension™ door and replace seat cover and infant insert (if used).

To open True Tension™ door, release lower anchors and lift door release button. If needed, slightly push child restraint against vehicle seat to relieve tension on lower anchor belt before releasing lower anchors.

**⚠ WARNING:** Check that child restraint is securely installed before each use.

### Check Installation

- Seat is in rear facing recline position.
- Leg rest is locked and making contact with the vehicle seat, positioned at the same angle as the vehicle seat back.
- Seat is securely installed. Hold seat near rear-facing belt path and move seat in all directions. Seat should move less than 1 inch.
- Tether strap is not used for rear facing installation and must be secured in storage location on back of child restraint.
- Cup holders may be placed in any position after installation.

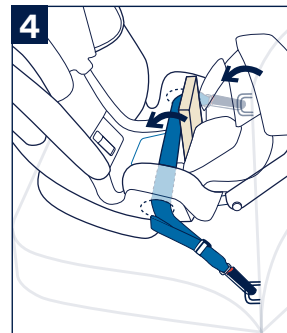
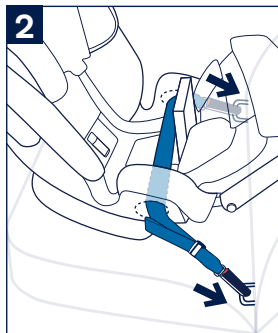
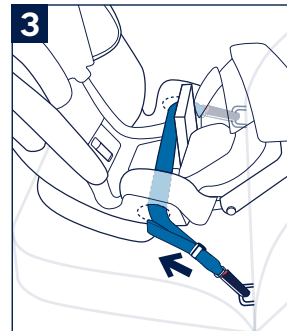
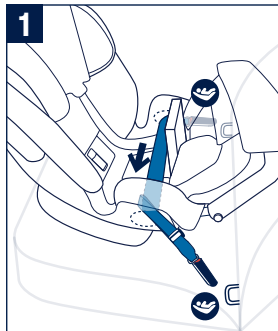

## Using Vehicle Lap Belt

**⚠ WARNING:** In this installation, the leg rest **CANNOT** be extended (must be pushed as far back into the child restraint as possible).

- 1 - Route vehicle lap belt through **BLUE** rear facing belt path and buckle vehicle lap belt **(1)**.  
Remove all slack from vehicle lap belt **(2)**.
- 2 - Close True Tension™ door and lock vehicle belt (refer to vehicle owner's manual). Test by pulling on lap belt to ensure it is locked.  
Replace seat cover and infant insert (if used).

To open True Tension™ door, unbuckle vehicle belt and lift door release button.

**⚠ WARNING:** Check that child restraint is securely installed before each use.

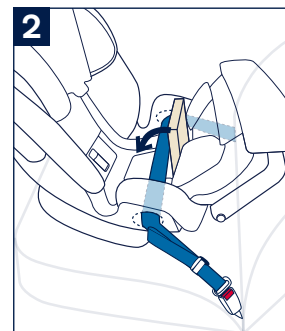
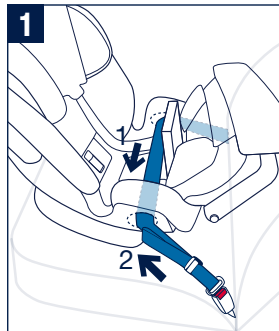

## Check Installation

- Seat is in rear facing recline position.
- Leg rest **CANNOT** be extended. It is locked and making contact with the vehicle seat, positioned at the same angle as the vehicle seat back.
- Seat is securely installed. Hold seat near rear facing belt path and move seat in all directions. Seat should move less than 1 inch.
- Tether strap is not used for rear facing installation and must be secured in storage location on back of child restraint.
- Cup holders may be placed in any position after installation.

# Forward Facing Installation

When rear-facing is outgrown, at least 2 years old,  
25–65 lb (11.3-29.4 kg), 49 in. (124 cm) or less

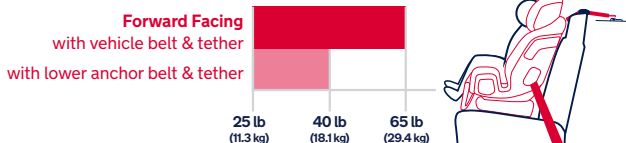

## Forward Facing Setup

Remove tether from storage and lengthen for use (p.38).

- 1 - Select desired forward facing recline position 1–4 (RED) (p.30).
- 2 - Place child restraint forward facing in a compatible vehicle seat (p.12) with the bottom of the restraint parallel to the vehicle seat bottom and the top of the restraint contacting the vehicle seat back. The leg rest **MUST NOT** be above the restraint seating surface.  
  
Loosen and unbuckle harness and retain with magnetic buckle tongue holders (p.22).
- 3 - Fully raise head support, lift seat cover, and open forward facing True Tension™ door (p.34).

Complete installation using your vehicle's lap/shoulder belt (p.52), the lower anchor belt (p.54), or a compatible vehicle lap belt (p.56).

Move leg rest to desired installation position (p.32).

**⚠ WARNING: DO NOT** install with **both** the vehicle seat belt and lower anchor belt.

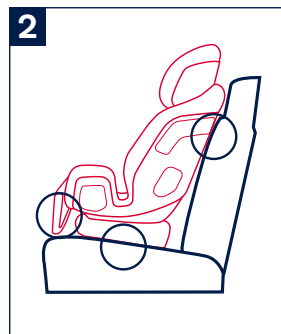
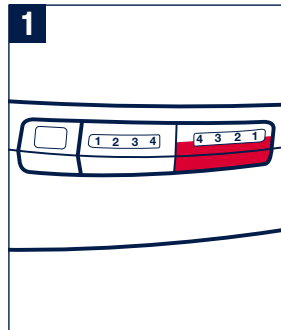

## Using Vehicle Lap/Shoulder Belt

(preferred installation method)

- 1 - Route vehicle lap/shoulder belt through **RED** forward facing belt path and buckle vehicle lap/shoulder belt **(1)**. Vehicle belt **MUST** be routed under True Tension™ door.

Remove all slack from the vehicle belt **(2)**.

Close True Tension™ door **(3)**. Lock vehicle belt (refer to vehicle owner's manual). Test by pulling on shoulder belt to ensure it is locked.

Replace seat cover.

- 2 - Attach tether hook to tether anchor on vehicle (p.38).
- 3 - Tighten by pulling on tether strap to remove all slack.

Tuck excess webbing behind child restraint.

To open True Tension™ door, unbuckle vehicle belt and lift door release button.

**⚠ WARNING:** Check that child restraint is securely installed before each use.

### Check Installation

- Seat is in forward facing recline position.
- Seat is securely installed. Hold seat near forward facing belt path and move seat side to side, front to back, and up and down. Seat should move less than 1 inch.
- Tether is properly used and attached to vehicle tether anchor.

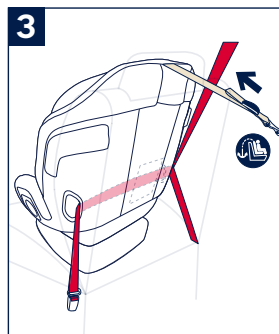
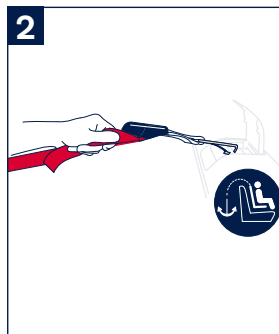
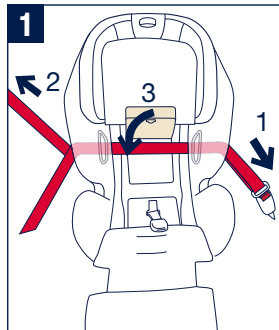

## Using Lower Anchor Belt

**⚠ WARNING:** Do not install by this method for a child weighing more than 40 lb (18.1 kg).

- 1 - Remove lower anchor belt from storage compartment (p.36) and route through **RED** forward facing belt path. Belt **MUST** be routed under True Tension™ door.
  - 2 - Lengthen lower anchor belt as necessary and attach to lower anchor points in vehicle.
  - 3 - Remove all slack from lower anchor belt by pulling loop at end of belt straight back from lower anchor connector (1).
- Close True Tension™ door (2). Replace seat cover.
- 4 - Attach tether hook to tether anchor on vehicle and tighten (p.38).

Tuck excess webbing behind child restraint.

To open True Tension™ door, release tether and lower anchors. If needed, slightly push child restraint against vehicle seat to relieve tension on lower anchor belt before releasing anchors. Lift door release button.

**⚠ WARNING:** Check that child restraint is securely installed before each use.

### Check Installation

- Seat is in forward facing recline position.
- Seat is securely installed. Hold seat near forward facing belt path and move seat side to side, front to back, and up and down. Seat should move less than 1 inch.
- Tether is properly used and attached to vehicle tether anchor.

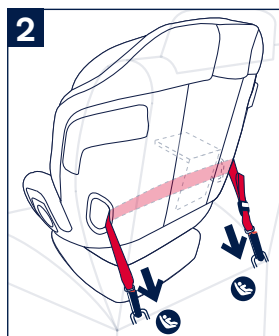
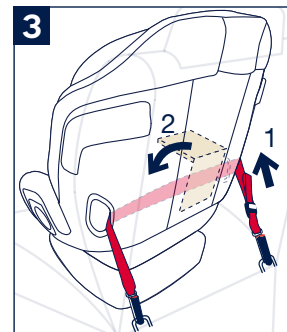
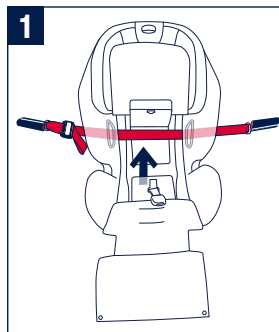

## Using Vehicle Lap Belt

- 1 - Route vehicle lap belt through **RED** forward facing belt path and buckle vehicle lap belt. **(1)** Vehicle belt **MUST** be routed under True Tension™ door.

Remove all slack from the vehicle lap belt to properly secure the child restraint **(2)**.

Close True Tension™ door **(3)**. Lock vehicle belt (refer to vehicle owner's manual). Test by pulling on lap belt to ensure it is locked.

Replace seat cover.

- 2 - Attach tether hook to tether anchor on vehicle (p.38).
- 3 - Tighten by pulling on tether strap to remove all slack.

Tuck excess webbing behind child restraint.

To open True Tension™ door, unbuckle vehicle belt and lift door release button.

**⚠ WARNING:** Check that child restraint is securely installed before each use.

### Check Installation

- Seat is in forward facing recline position.
- Seat is securely installed. Hold seat near forward facing belt path and move seat side to side, front to back, and up and down. Seat should move less than 1 inch.
- Tether is properly used and attached to vehicle tether anchor.

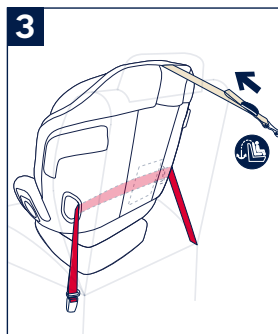
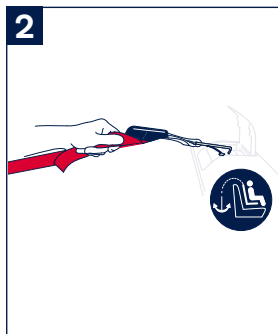
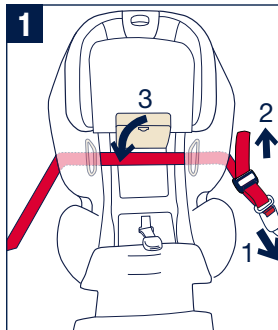

# Booster Installation

At least 4 years old 40–120 lb (18.1-54 kg),  
38-57 in. (96.5-145 cm) tall

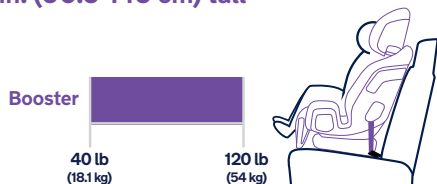

## Booster Setup

- 1 - **⚠** Harness **MUST** be stored when using the child restraint as a booster. Raise head support (p.30) and store harness straps and harness buckle inside the seat (p.40).
- 2 - Place child restraint forward facing in a compatible vehicle seat that has both a lap belt and a shoulder belt (p.12). The bottom of the restraint should be parallel to the vehicle seat bottom and the top of the restraint should contact the vehicle seat back. The leg rest **MUST NOT** be above the restraint seating surface.
- 3 - Select desired booster recline position 1–4 (PURPLE) (p.30).

Adjust or remove the vehicle headrest as needed to remove interference. If you remove your vehicle headrest, be sure to store it in a secure place; check your vehicle owner's manual.

- 4 - Open seat cover.

Complete installation with the lower anchor belt (p.62) or, if necessary, without (p.64).

Move leg rest to desired installation position (p.32).

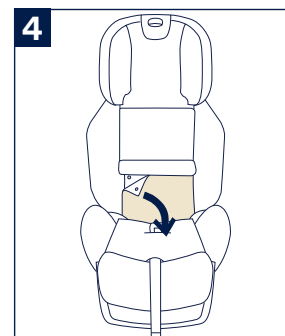
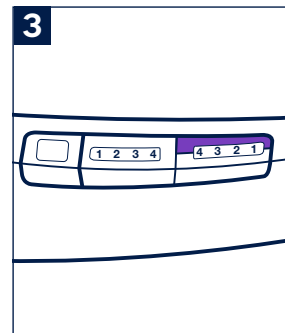
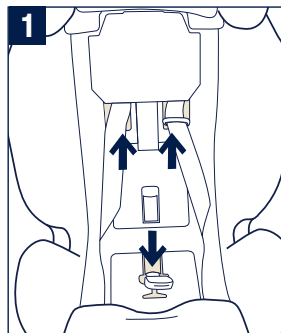

## Booster Installation (continued)

- 1 - **DO NOT** use with the booster reclined beyond positions 1–4 (PURPLE).
- 2 - **DO NOT** use with the vehicle seat not in an upright position.
- 3 - **DO NOT** use with the vehicle seat angled forward.
- 4 - The front of the booster **MUST NOT** hang over the front of the vehicle seat.

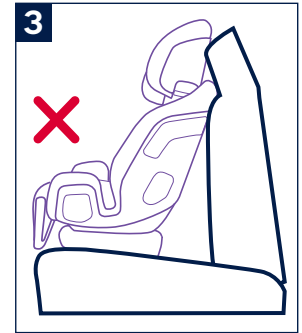



## Using Lower Anchor Belt

(preferred installation method)

**⚠ WARNING:** Booster **MUST** remain secured by lower anchor belt even when unoccupied to avoid becoming a projectile in the vehicle.

- 1 - Remove lower anchor belt from storage compartment (p.36) and route through **RED** forward facing belt path. Belt **MUST** be routed under forward facing (**RED**) True Tension™ door.
- 2 - Lengthen lower anchor belt as necessary and attach to lower anchor points in vehicle.

Lower anchor belt **MUST NOT** interfere with the vehicle seat belt.

- 3 - Remove all slack from lower anchor belt by pulling loop at end of belt straight back from latch connector (1). Close True Tension™ door (2). Replace seat cover.

**⚠ WARNING:** Check that child restraint is securely installed before each use.

### Check Installation

- Harness is stored.
- Seat is in booster recline position.
- Seat does not interfere with the vehicle headrest.
- Seat is securely installed. Hold seat near forward facing belt path and move seat side to side, front to back, and up and down. Seat should move less than 1 inch.

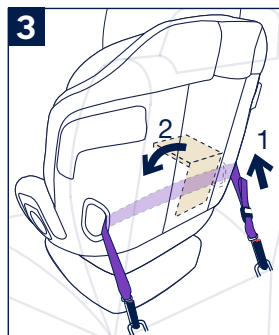
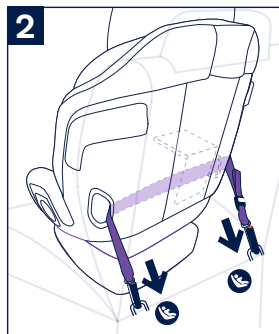
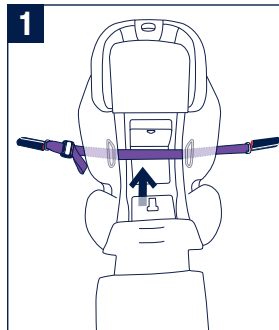

## Without Lower Anchors

This installation should **ONLY** be used if installation with lower anchors is not possible.

**⚠ WARNING:** When **NOT** secured by lower anchors, booster **MUST** be secured with vehicle belt when unoccupied to avoid becoming a projectile. Route vehicle belt as in forward facing use (p.52 or 56) or as though securing a child.

- 1 - **⚠ WARNING:** When the child restraint is installed without lower anchors, the leg rest **MUST** be minimally extended and angled down towards the vehicle seat (p.32).
- 2 - Leg rest **MUST NOT** be extended or angled out enough that a child can step on it and tip the child restraint over, which could cause serious injury.
- 3 - Leg rest **MUST NOT** be pushing into the vehicle seat enough to lift the child restraint off the seat.
- 4 - When not using lower anchors, the back of the booster seat **MUST** fit tightly against the back and bottom of the vehicle seat. Adjust or remove the vehicle headrest as needed to remove interference.

**⚠ WARNING:** Check that child restraint is securely installed before each use.

### Check Installation

- Harness is stored.
- Seat is in booster recline position.
- Seat does not interfere with the vehicle headrest.
- Leg rest is minimally extended and down against vehicle seat.
- Back and bottom of booster fit tightly against vehicle seat.

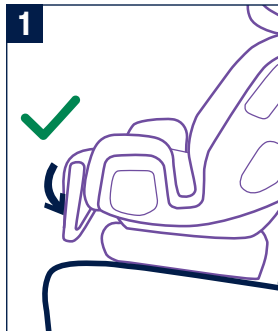

# Securing Child

**⚠ WARNING:** If your child is not properly secured in the child restraint, they may be ejected in a crash, resulting in serious injury or death.

## With Built-in Harness (Rear/Forward Facing)

Loosen and unbuckle harness. Retain with magnetic buckle tongue holders (p.22).

**1** - Place child in child restraint with child's back flat against child restraint seat back. **DO NOT** allow child to slouch.

If child's head falls forward, recline the seat more.

**2** - For **rear facing** use, adjust head support (p.30) to position harness **AT or just below** shoulders.

For **forward facing** use, adjust head support (p.30) to position harness **AT or just above** shoulders.

Adjust harness buckle to fit child (p.28). Harness buckle should be close to, but not under child.

Position harness over child's shoulders and around child's waist, and buckle harness.

**3** - Remove slack from shoulder straps and waist belt by pulling up on shoulder straps **(1)**. Pull harness adjustment strap **(2)** to tighten. Harness should fit snugly on child's shoulders and thighs; it is snug if you cannot pinch a fold in the strap horizontally.

Fasten and position chest clip (p.22) level with child's armpits **(3)**.

A snug strap should not allow any slack. It lies in a relatively straight line without sagging. It does not press on the child's flesh or push the child's body into an unnatural position.

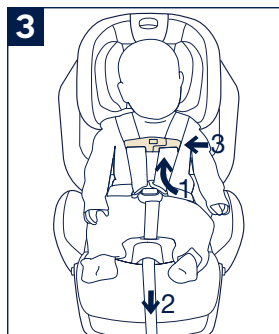
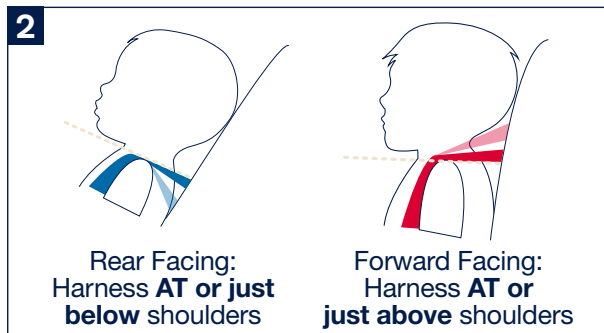
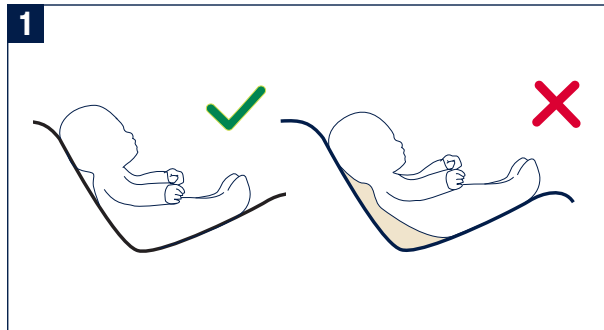

## Without Built-in Harness (Booster)

Make sure the harness and harness buckle are stored inside the seat (p.40).

With the booster installed in the vehicle, have the child sit in the booster with their back flat against the booster seat back.

- 1 - Route the vehicle belt across the child's chest and through the **PURPLE** lower belt path toward the vehicle buckle.
- 2 - Secure the vehicle buckle and listen for a "click." Pull on vehicle belt to remove slack.
- 3 - Route the vehicle shoulder belt through the **PURPLE** shoulder belt guide (p.40).

**⚠** The vehicle shoulder belt **MUST**:

- route completely through the guide
- lie between the child's neck and shoulder
- not fall off the child's shoulder

The vehicle lap belt **MUST** lie flat and snug across the child's thighs.

- 4 - Adjust the head support (p.30). The correct head support height is obtained when the vehicle shoulder belt is:
  - between the child's neck and shoulder
  - flat across the center of the child's chest.

Bottom of head support will be approximately even with the top of child's shoulders.

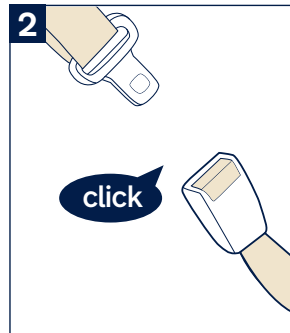

# Cleaning and Maintenance

## Cleaning the Seat Cover, Slip Cover, Harness Pads, and Infant Insert

Seat cover, slip cover, harness pads, and infant insert can be cleaned according to the instructions on the tag attached to the seat cover. Infant insert support wedge should be spot cleaned only.

## Cleaning the Harness

The child restraint harness system cannot be removed. **DO NOT attempt to remove the harness system.** When required, harness may be cleaned with a cloth and warm, soapy water.

Towel dry excess water and allow to air dry.

## Cleaning the Shell

Shell may be cleaned with a damp cloth.

Towel dry.

**DO NOT** use abrasive cleansers on the shell.

## Cleaning the Buckle

**BUCKLE CANNOT BE REMOVED.**

To clean buckle, wipe with damp cloth.

**DO NOT** use bleach or other harsh chemicals to clean any part of the seat.

**DO NOT** attempt to iron the covers or pads.

