

Lindab **Roof Drainage System**

Lindab Rainline™

Assembly instructions



Assembly instructions

Before you start

It is the total area of the roof that decides the dimensions of the roof drainage system. The bigger the roof, the more water the system must take care of. It will pay in the long run to be careful when you measure your roof and calculate dimensions. Take your calculation to your local dealer, who will help you to pick out all the components you need. Please, also visit our web site for dimensioning help.

Measure the roof area

There are various types of roofs but measure each roof part by multiplying the roof length with the roof width. If the area is less than 50 m² use gutters with 100 mm width and pipes with 75 mm diameter. If the area is between 50-100 m² use gutters with 125 mm width and pipes with 87 mm diameter. If the area is larger than 100 m² there

are gutters with 150 mm width and pipes with 100 mm diameter or 190 mm gutters and 111/120 mm pipes. If there are different roof sizes on the same building the largest roof part is dimensional.

Number of brackets and drain pipes

The brackets should be mounted with c/c 600 mm. The end brackets are mounted 100 mm from the roof edge.

The inclination of the gutter towards the down pipe should be at least 2,5 mm/m. Calculate how many brackets you need for each roof part (example 10 m/0,6 m + 1 = 18 brackets). Each drain pipe covers maximum 10 m gutter fall (length of the house). For an esthetic reasons or if the gutter fall exceeds 10 m, place pipes on each corner of the house.

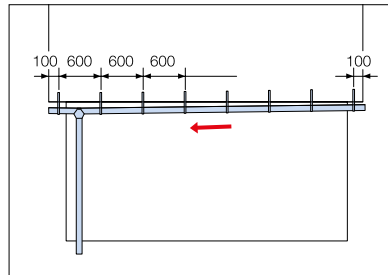

One downpipe for roof length less than 10 m

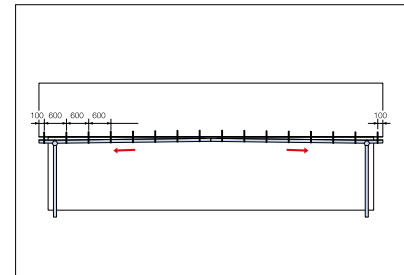

Two downpipes for roof length exceeding 10 m

Where to place the pipes

The pictures below show recommended placement of drainpipes for different houses.

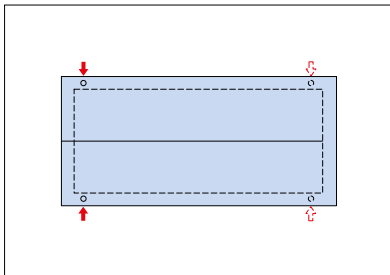

Saddle roof. 1 or 2 per side.

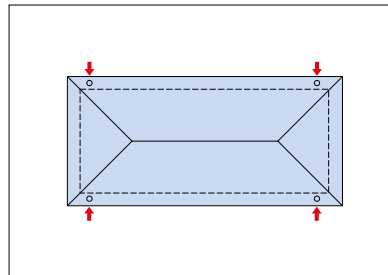

Hipped roof

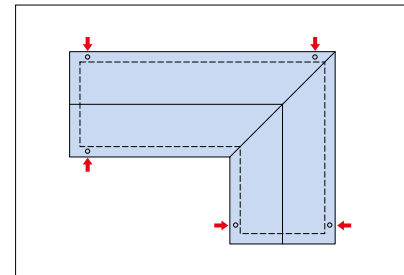

L-shaped roof

Assembly instructions

Transport, storage, unpacking

Make sure that the roof drainage components are handled with care during transport, storage and unpacking. If not, the coating may be damaged or the pipes and gutters dented. Store pipes and gutters on a plane and stable surface.

Non coated components must be unpacked and stored in a dry and ventilated place.

Cutting

Cut the gutters and pipes with plate shears or a hacksaw on a firm underlay on the ground. Never use an angle grinder. It heats the steel up and thus destroys the galvanization. The coating may also be scorched by hot chips or filings.

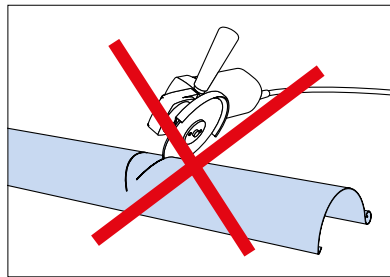

Never use an angle grinder

After-treatment

If the coating has been damaged, paint it with Lindab's repair paint to prolong the lifespan of the roof drainage system. Use a sponge or Lindab's paint nib.

Maintenance

If you want to keep the roof drainage system in mint condition, give the system an overhaul a couple of times a year. Clean the gutter and pipes from leaves and twigs. Wash with water and a mild detergent. Don't use a high pressure washing appliance.

Tools

Lindab's roof drainage system can be mounted with ordinary hand tools like pliers, hammer, hacksaw, screwdriver, folding rule and string. For bending brackets, you need a bracket bender. Contact your local dealer and they will lend you one.

Fastening

The fasteners you need are for fastening the brackets and the pipe holders. We always recommend that you use stainless screws and use the right screws intended for each material. The pipe holders are mounted on the house façade. Check if it's wood, concrete or bricks.

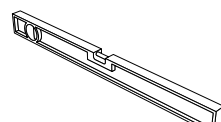

Spirit level

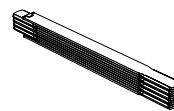

Folding rule



Pencil



Screw driver

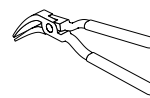

Seam plier

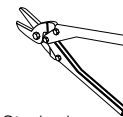

Steel scissors

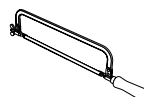

Hack saw

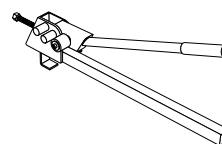

Bracket bender

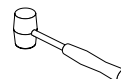

Rubber hammer

Product overview

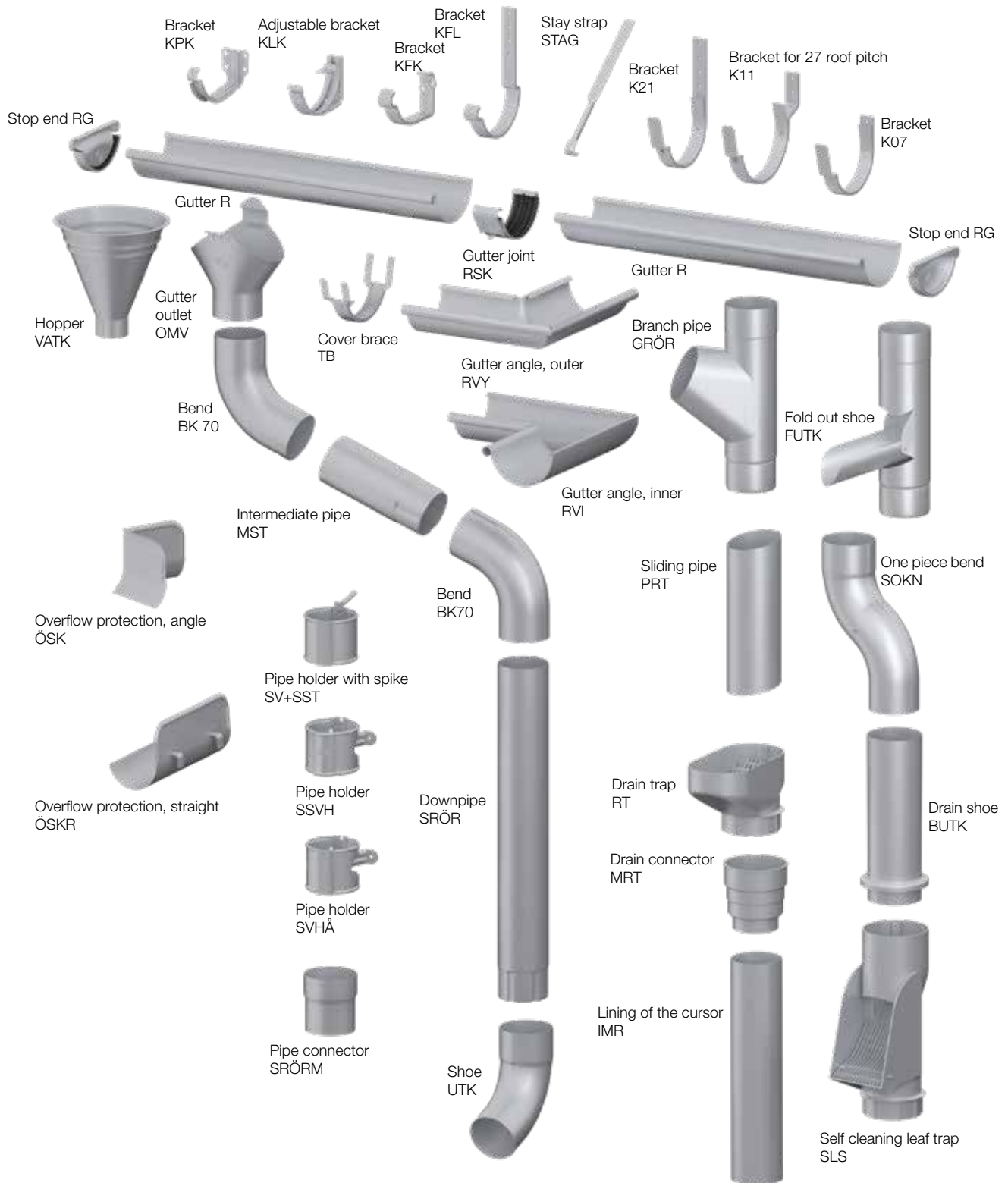

Assembly – Roof Drainage System

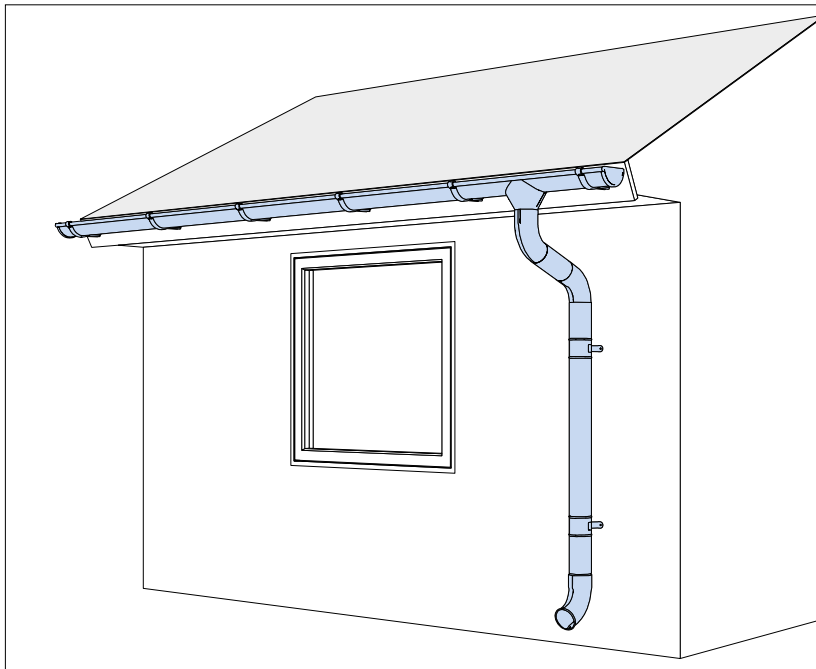
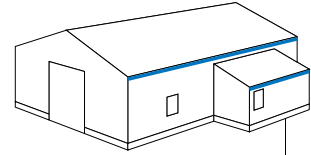

Roof base

Depending on the roof construction of the building different types of brackets can be used. An adjustable bracket is used in the assembly instruction that follows. Other bracket applications are also shown as separate instructions. The brackets that can be used are:

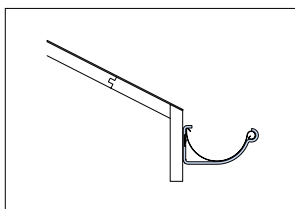

Lindab KFK bracket

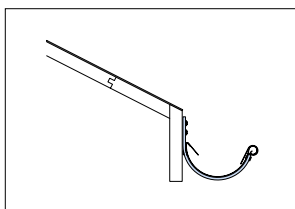

Lindab K07 bracket

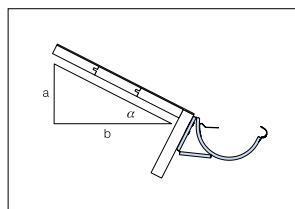

Lindab KLK Adjustable bracket

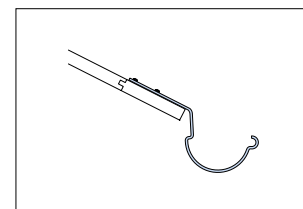

Lindab KFM/KFL bracket

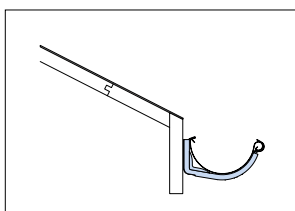

Lindab KPK bracket

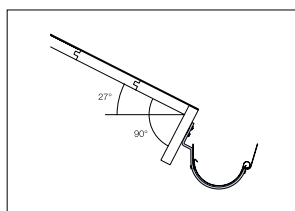

Lindab K11 bracket

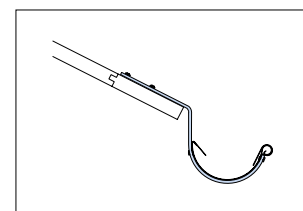

Lindab K16/K21 bracket

Assembly – Roof Drainage System

Bracket assembly

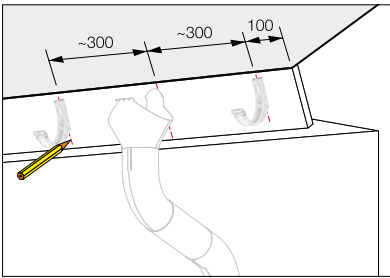

Mark out for the brackets KLK around the down pipe.

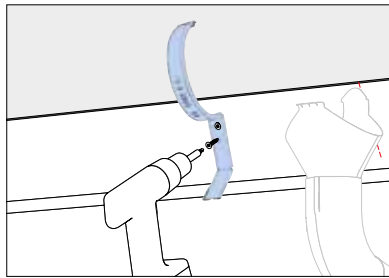

Fasten the "low bracket" 300 mm left to the down pipe mark.

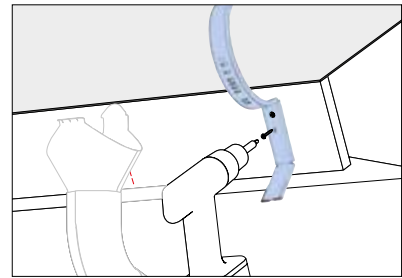

Fasten the bracket right of the down pipe mark 2,5 mm higher than the low bracket.

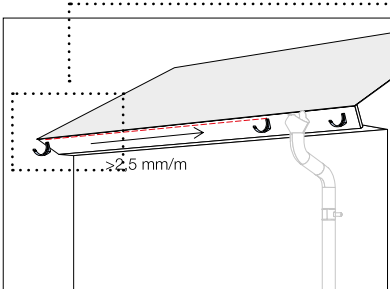

Fasten "high bracket" at the opposite end of roof base. The inclination to the pipe shall be 2,5 mm/m.

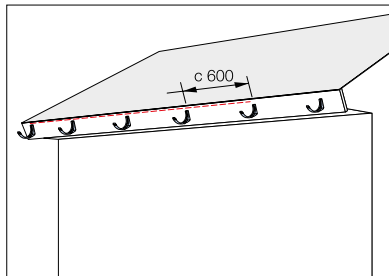

Fasten the other brackets with c/c 600 mm along the string.

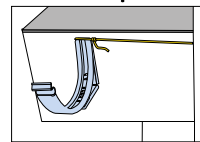

Put a string between the high and low bracket. It will help you to place the other brackets.

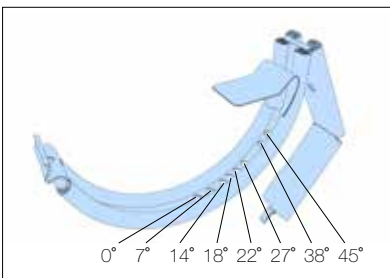

The KLK bracket can be adjusted for different roof pitches.

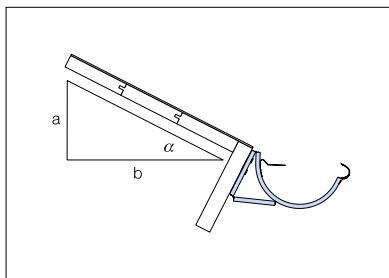

Calculate your roof pitch and adjust the bracket accordingly.

		α
1	1	45°
1	1,25	38°
1	2	27°
1	2,5	22°
1	3	18°
1	4	14°
1	8	7°
1	∞	0°

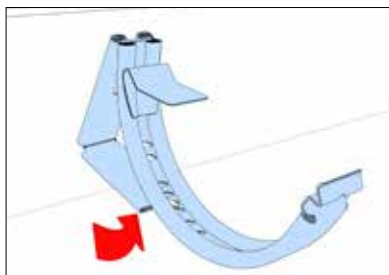
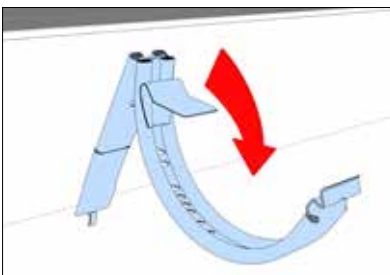

Use screwdriver to fold the tap forward for low inclinations and backwards for $\alpha \geq 22^\circ$.

Assembly – Roof Drainage System

Gutter assembly

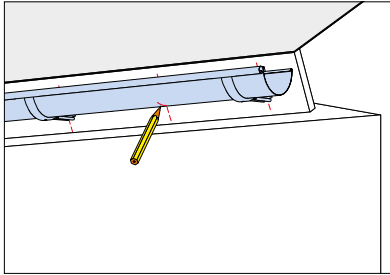

Place the gutter in the brackets and mark out for the gutter outlet OMV on the gutter.

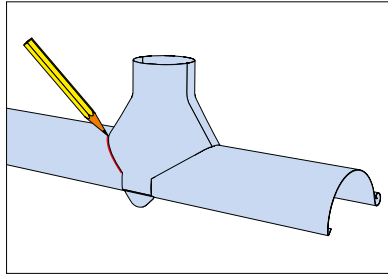

Use the outlet as template on the gutter.

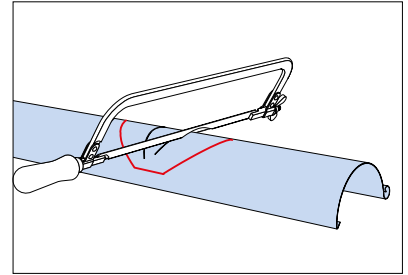

Use a hacksaw to make a hole in the gutter.

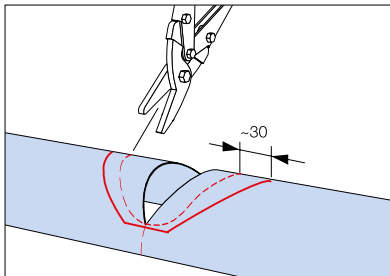

Finish by cutting up to the bead and backside as shown in picture.

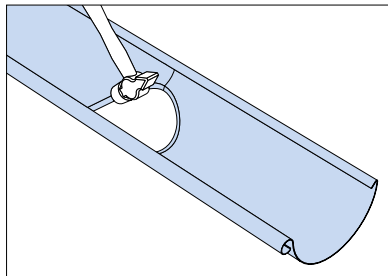

To get a smooth water fall, use a hammer on the edges.

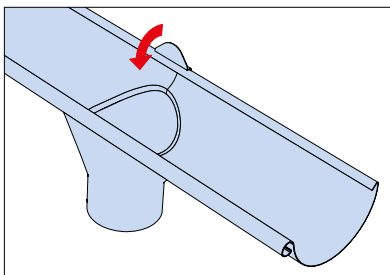
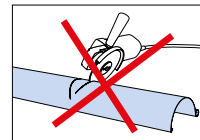

The gutter outlet closes easily on the gutter.

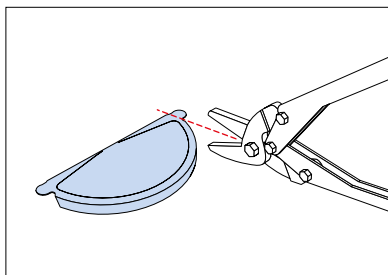

Cut or fold the ear not used.

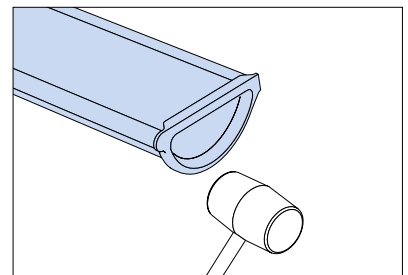

The stop end RG is self sealing. Use a rubber hammer to fix it to the gutter.

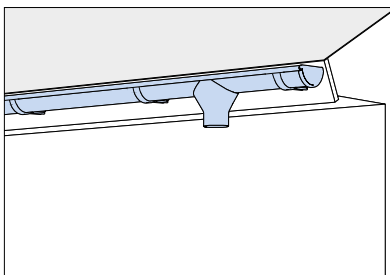

Place the gutter in the brackets.



Assembly – Roof Drainage System

Gutter joint

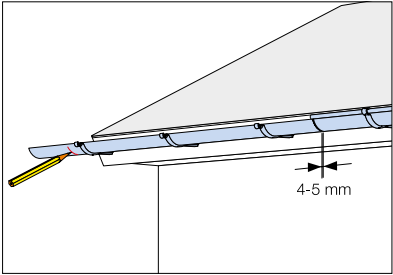

Place the gutter to be jointed in the brackets and mark out the needed length

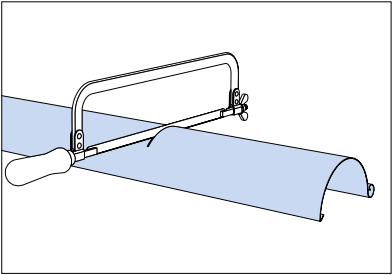

Use a hack saw to cut the gutter.

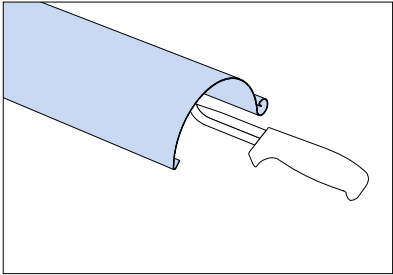

Remove the filings.

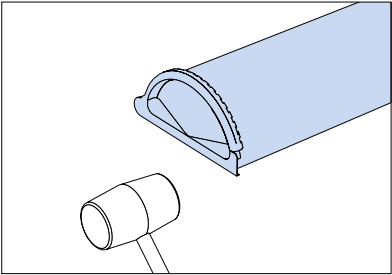

Assemble the stop end RG.

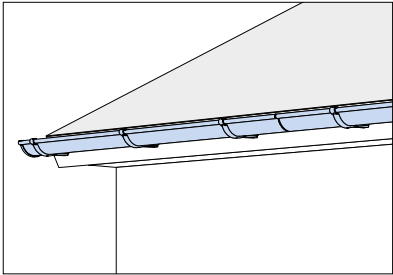

Place the gutter in the bracket.

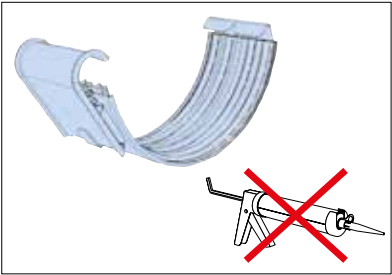

Use self sealing RSK gutter joint. Silicone should not be used.

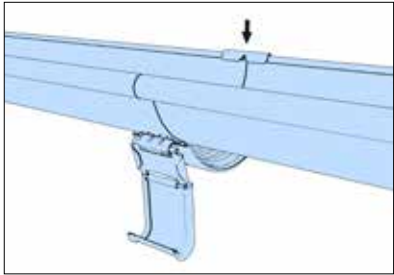

Place the gutter joint over the gutter

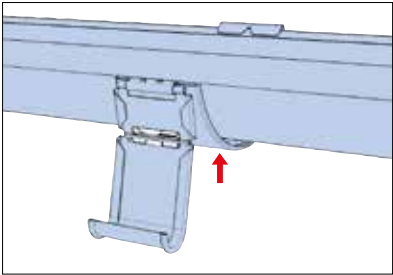

Press the sealing to the gutter.

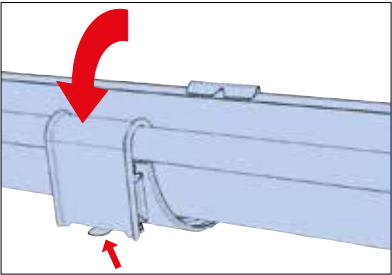

Close the gutter joint

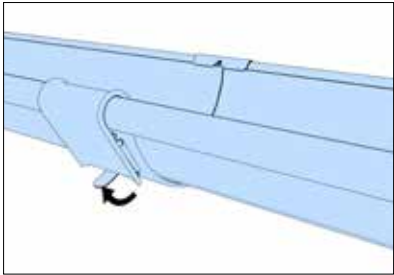

and lock.

Assembly – Roof Drainage System

Down pipe bends

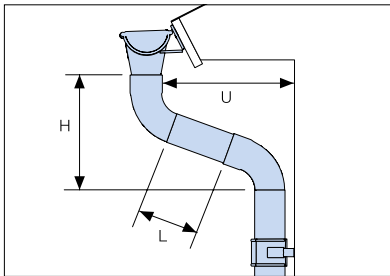

Check the measures to get the length of the intermediate pipe MST. Use table on the side.

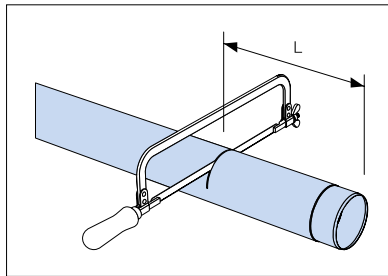

Use a hack saw to cut the intermediate pipe MST. Remove sharp metal filings with a knife.

Intermediate pipelength at 70° bends

U mm	H mm	L mm
220	275	0
270	290	100
300	300	135
350	320	185
400	340	240
450	355	290
500	375	345
550	395	400
600	410	455
650	430	505
700	450	560
750	465	610
800	485	665
850	505	720
900	520	770
950	540	825
1000	555	880
1050	575	930
1100	595	985
1150	610	1040
1200	630	1090

Down pipe and holder

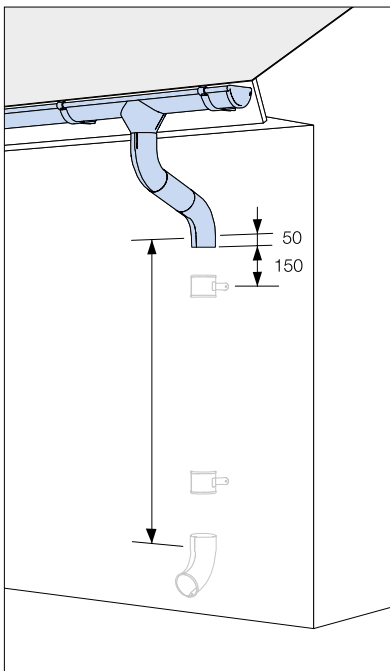

Measure the length of the down pipe. Mark out for the pipe holders SSVU

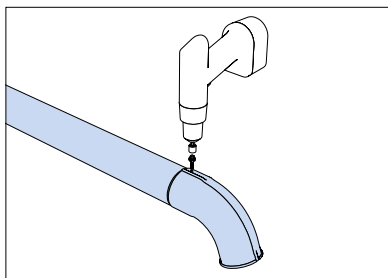

Assemble the pipe Shoe UTK. Use a self tapping screw on the back side.

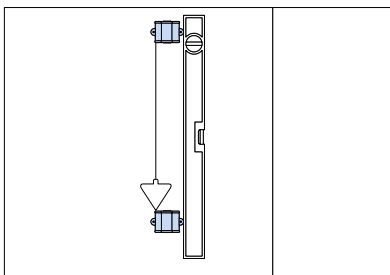

Level the pipe holders with spirit level or plummet.

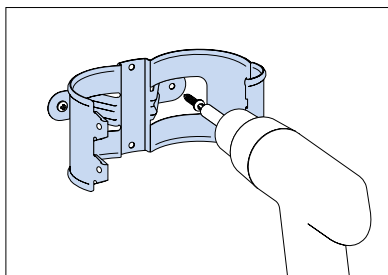

Fasten the pipe holder on the wall.

Assembly – Roof Drainage System

Close up assembly pipe holder SSVU

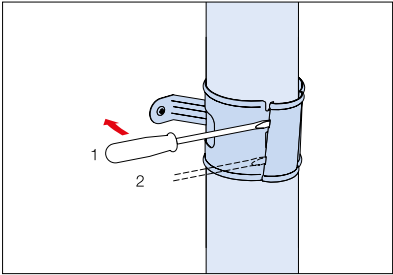
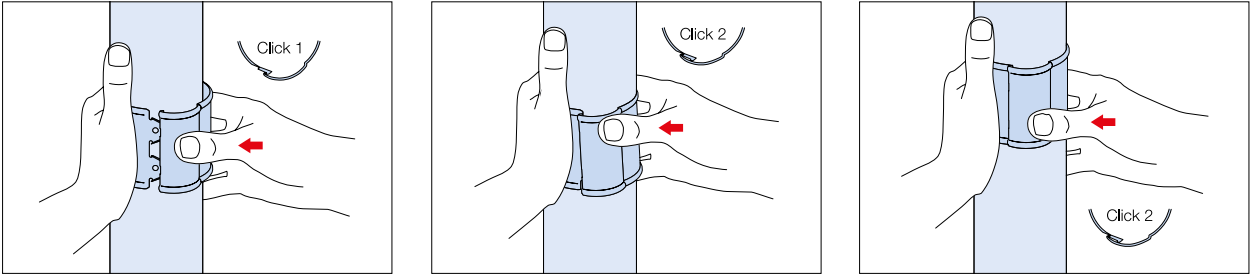

It's easily done to dismount the holder.

Bracket KPK

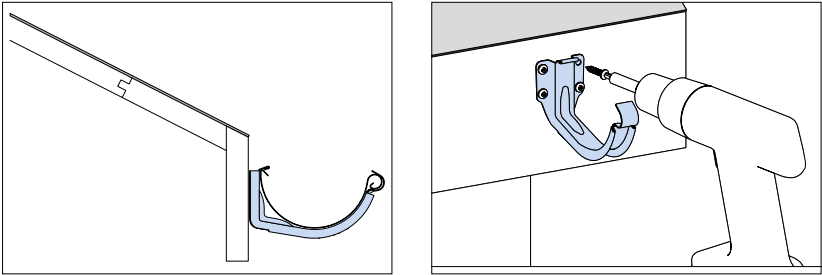

Alternative to use bracket KPK for perpendicular roof base.

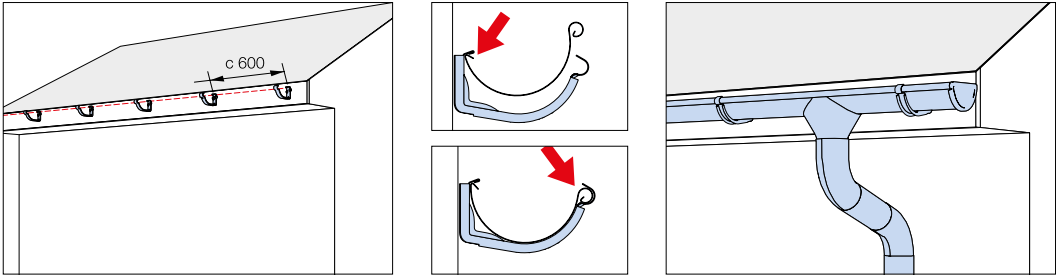

The inclination shall be 2,5 mm/m.

Assembly – Roof Drainage System

Bracket KFK

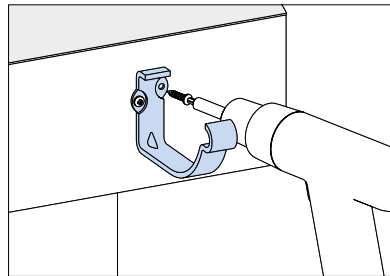
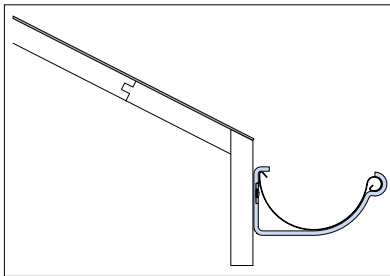

Alternative to use bracket KFK for perpendicular roof base.

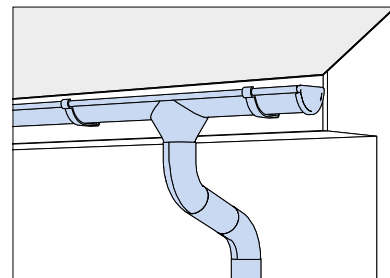
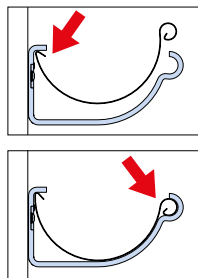
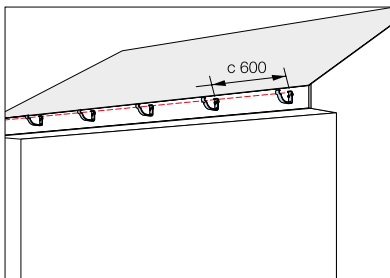

The inclination shall be 2,5 mm/m.

Bracket K07

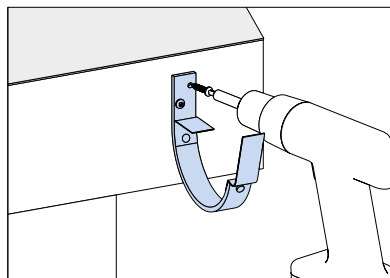
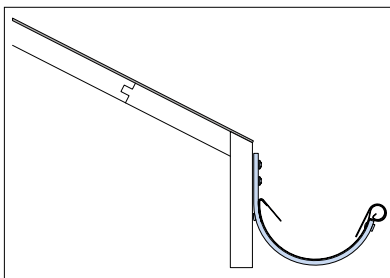

Alternative to use bracket K for perpendicular roof base.

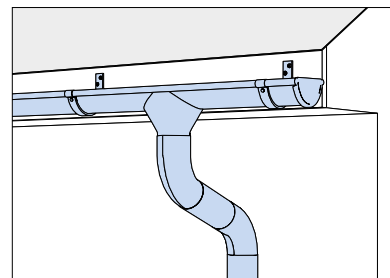
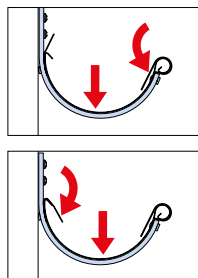
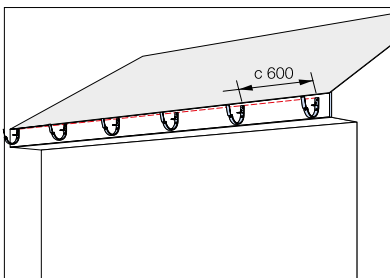

The inclination shall be 2,5 mm/m.

Assembly – Roof Drainage System

Bracket K11

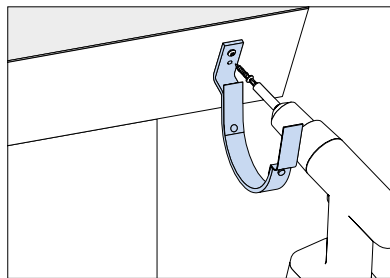
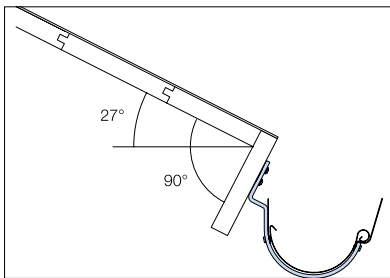

Use bracket K11 for 27° roof pitch.

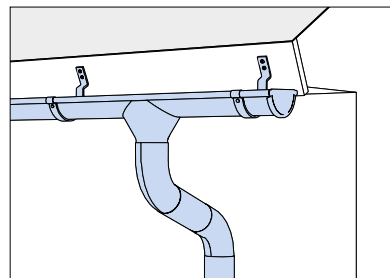
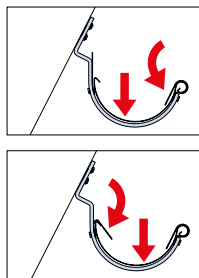
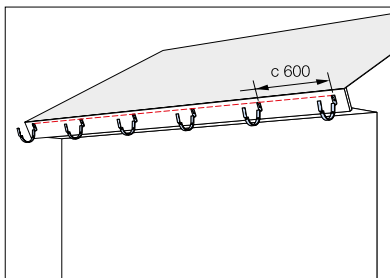

The inclination shall be 2,5 mm/m.

Bracket KFM/KFL

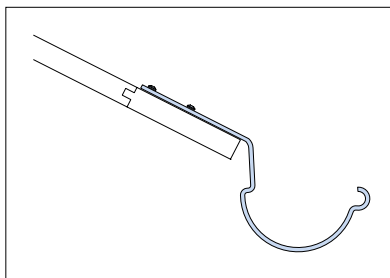

Alternative to use bracket KFL

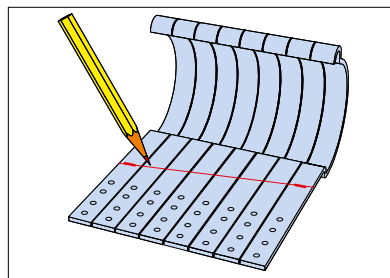

Mark out on the brackets for the gutter incline. 2,5 mm/m.

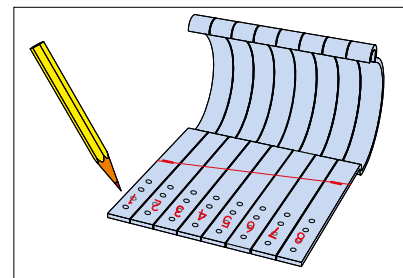

Number the brackets. 1 is for "Low bracket". Last bracket is "High bracket".

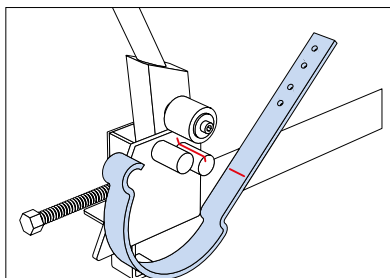

Bend the brackets at the marking. Minimum radius 10 mm.

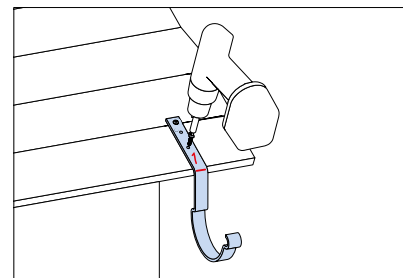
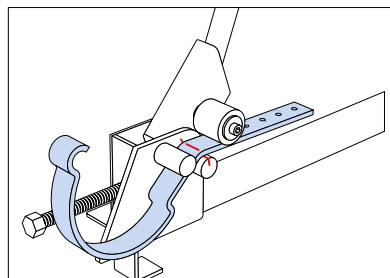

Mount brackets no.1 "Low bracket", and fasten the other brackets accordingly.

Assembly – Roof Drainage System

Traditional gutter joint

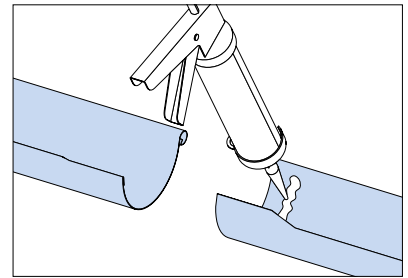
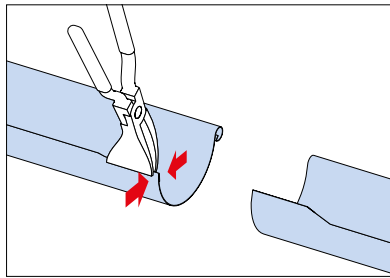
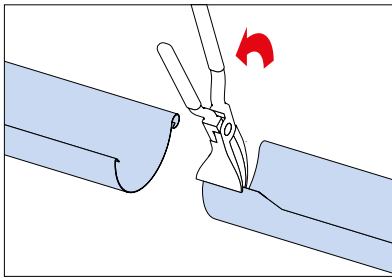

Use silicone as sealing.

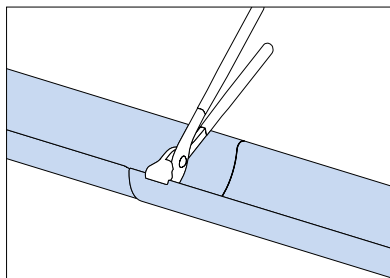
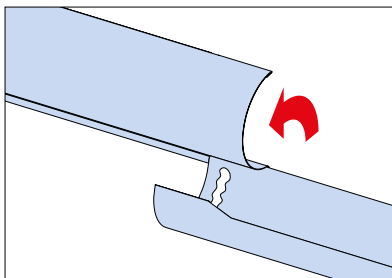

Traditional Stop end RGV and RGH

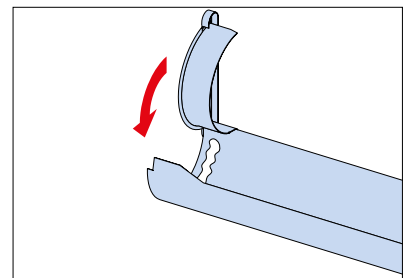
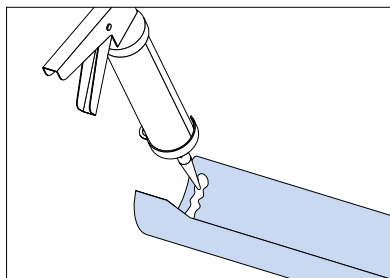
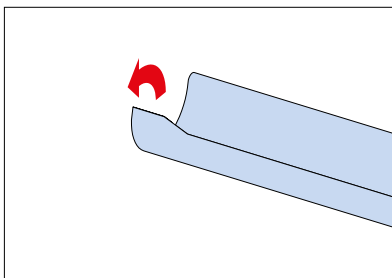

Use silicone as sealing.

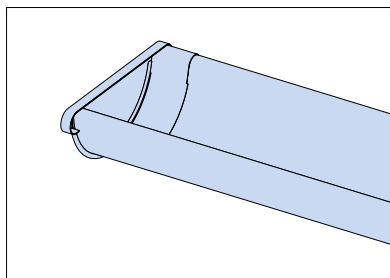
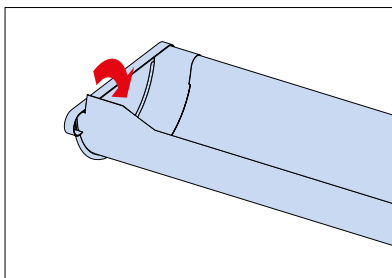

Assembly – Roof Drainage System

Overflow protection ÖSK and ÖSKR

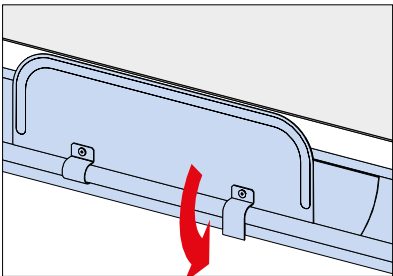

Place Overflow protection ÖSKR in the gutter.

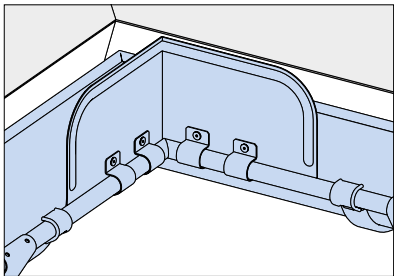
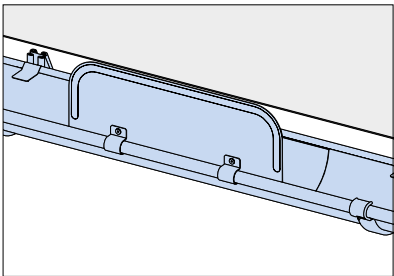

Overflow protection ÖSK for gutter angles.

Cover brace TB

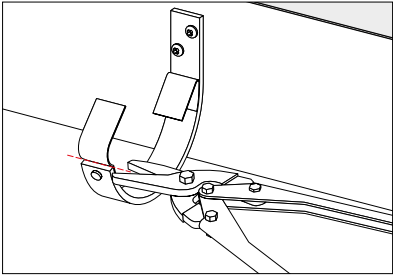

Cut off the front fold piece on the old bracket.

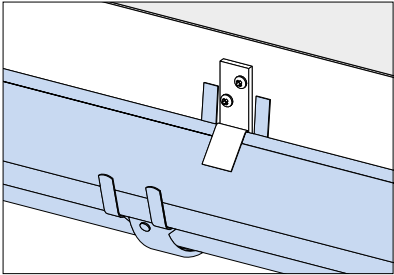

Place the cover brace TB over the old bracket.

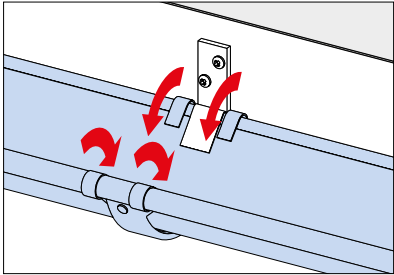

Gutter angle RVI/RVY

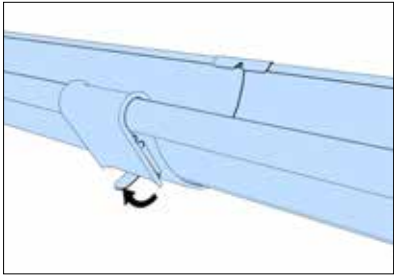
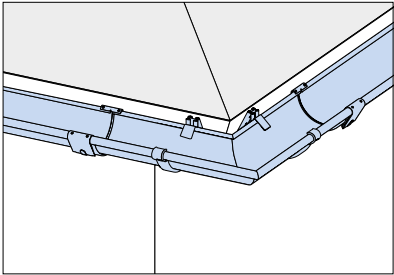
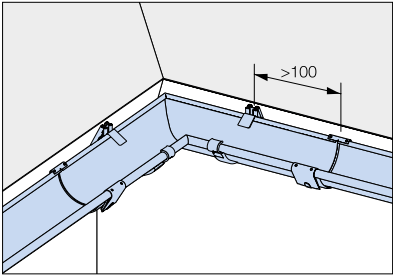

Gutter joint RSK.

Pipeholder SSVU with SST or SSC

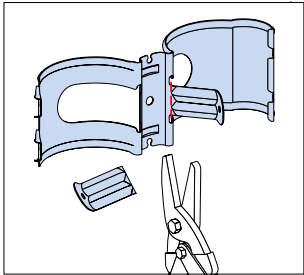
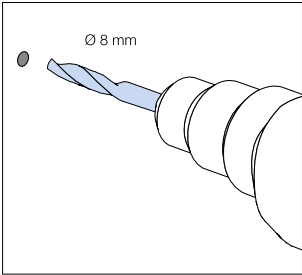

Cut of the legs for use of SSVU with SST and SSC.

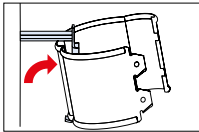
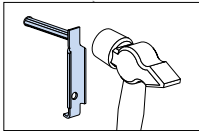

SST...

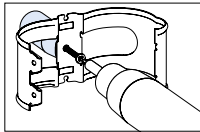

... or SSC.

Assembly – Roof Drainage System

Adjustable shoe FUTK

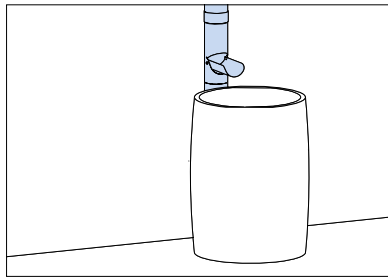
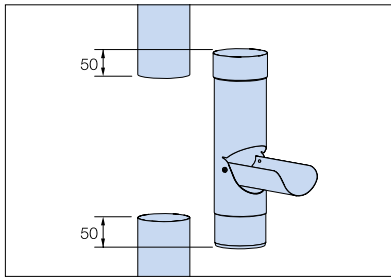

Adjustable branch GRÖR

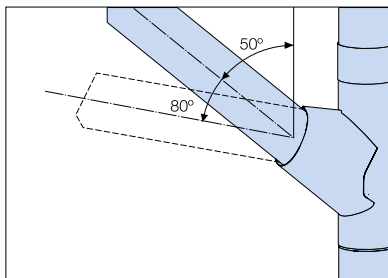
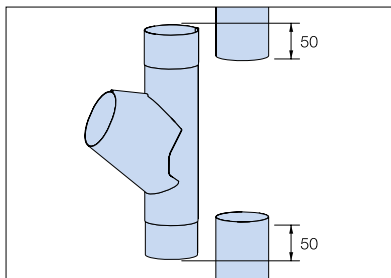

Connect a branch pipe. Can be mounted in angle 50-80°.

Leaf filter DVSIL

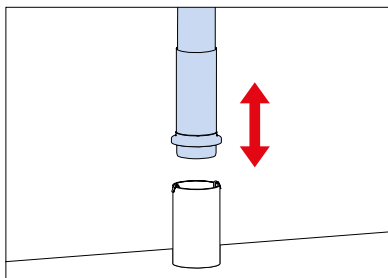
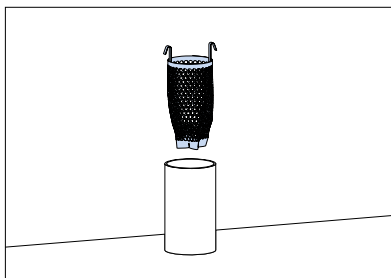

Connect the drain shoe BUTK

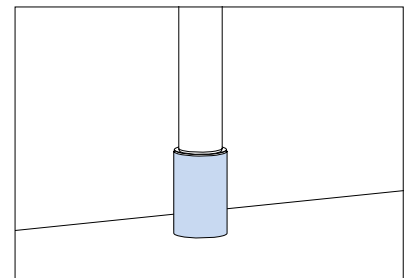

Use IMR in the same color as your rainwater system to cover the pipe from the ground.

Drain trap RT

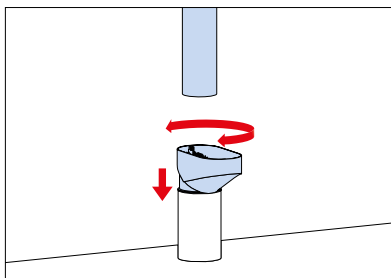

Place the drain trap in the ground pipe.

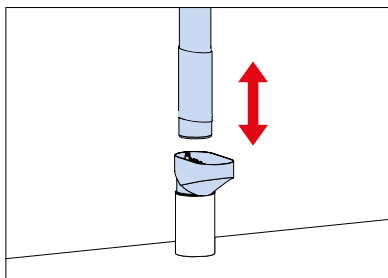

Connect the sliding pipe PRT.

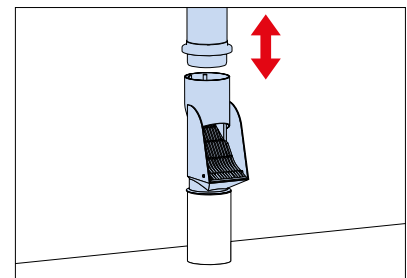

You can also use a self cleaning leaf trap SLS. Use BUTK to connect.



Good Thinking

At Lindab, good thinking is a philosophy that guides us in everything we do. We have made it our mission to create a healthy indoor climate – and to simplify the construction of sustainable buildings. We do that by designing innovative products and solutions that are easy to use, as well as offering efficient availability and logistics. We are also working on ways to reduce our impact on our environment and climate. We do that by developing methods to produce our solutions using a minimum of energy and natural resources, and by reducing negative effects on the environment. We use steel in our products. It's one of few materials that can be recycled an infinite number of times without losing any of its properties. That means less carbon emissions in nature and less energy wasted.

We simplify construction