



lindab | we simplify construction



# Lindab**Rainline**

July 2022 Price List





# We're here to help

At Lindab Profile, our aim is to match the reliability of our products with that of our service. Customer support is a core part of our business philosophy.

Our customers are the people we meet on a daily basis, rather than the companies they work at. It is alongside all these people – designers and architects, fitters and installers – that we have built our trust. Lindab is a partner you can trust. Our relations are based on an in-depth understanding of the challenges our customers face. We create our solutions based on these needs and challenges.

### We are always near

We are proud of the relationships we have developed with local authorities, housing associations, exclusive developers, contractors and end-users across the UK. Thanks to unique customer contacts, we can predict what you need and adapt our offering to suit specific local requirements. It is important to us, because it is important to you, that we optimise the various sales channels we have on each market.

We have a dedicated team of UK regional Business Development Managers and Specification Managers who have been trained to the highest degree on our Rainwater System. Our team is available to visit you, we will give you full technical support on site and work closely with your designated contractor. Our team can also offer product training and marketing materials to enable you to make the choice that is right for you.

### There when you need us

In a UK market undergoing rapid transformation, there are increasing demands on simplification, speed, flexibility and reliability. We meet these demands and simplify the construction process – before, during and after. We do this with a sustainable supply chain, efficient logistics and a customer-focused flow that creates greater value for you.

We have a committed customer support team at our UK sales office. They can provide you with technical assistance, quotes, order entry and problem-solving solutions just by picking up the phone. Send us your building drawings and we will even do a 'product take-off' for you free of charge.

#### Orders & general enquiries

Tel: 0121 585 2780

Email: [profile@lindab.co.uk](mailto:profile@lindab.co.uk)

#### Quotes & technical enquiries

Tel: 0121 585 2788

Email: [profile.technical@lindab.co.uk](mailto:profile.technical@lindab.co.uk)

#### Opening Times:

Monday – Thursday 8am-5pm

Friday 8am-4pm

## Contents

Features & Benefits	4	Vandal Reinforced Pipes	32
Colours & Finishes	6	Accessories	34
Half Round Gutters & Fittings	12	Size Guide	36
Rectangular Gutters & Fittings	20	Design & Specification	41
Pipes & Fittings	23		

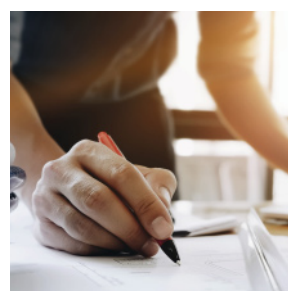

# Have confidence

Our fundamental idea is to contribute to simplifying construction in all phases of the construction process: in the design phase of the product itself, its installation and performance. Quality management systems are applied throughout the business. Lindab's production units have quality systems certified to ISO 9001.

Lindab are committed members of the Builders Merchant Federation, the Metal Gutter Manufacturers Association and the RIBA CPD Providers Network.



## Right place, right time

We have a network of approved distributors across the UK which can help you with orders, quotes and arranging visits from our regional managers. Deliveries are made from our UK distribution centre to your local distributor or directly to a site of your choice. Care should be taken for health and safety of personnel when handling consignments.

Normal delivery time is 3-7 working days, items that are not held in stock in the UK will have an extended lead time. Orders placed are subject to VAT at the current rate, terms and conditions apply. Carriage charges may be applicable.

## Lindab Express

Enhanced delivery times are available for standard stocked items.

Although we always process customer orders efficiently and we are proud of our ability to deliver consistently on time-in full we know that there are occasions when this is not quick enough. Our Lindab Express delivery service can guarantee next day delivery for orders received and acknowledged by our sales office before 11am.

Lindab Express is only available for standard items that are held in stock at our UK distribution centre. The Lindab Express logo is displayed next to applicable items. Express service is subject to product and haulage availability, additional carriage charges will apply. Next day delivery may not be available to all postcode areas.

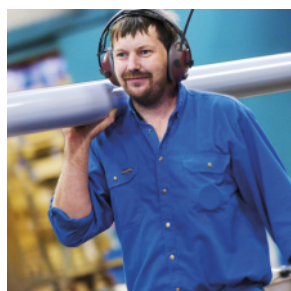



# Features and Benefits of Lindab Rainline

## The sustainable choice

Tests have proven that steel has the lowest carbon footprint of any rainwater system. Manufactured from up to 30% recycled material, having an expected useful life of up to 70 years, and being completely recyclable means that the lifespan environmental impact of steel is much less than plastics and other metals.



## Looks that last

Stylish design available in a choice of 10 painted colours and unpainted Magestic galvanised steel or natural copper finishes. Painted steel has a thick layer of zinc coating on both sides of the steel core to protect from corrosion. High-build, scratch-resistant polyester paint is UV stable and has excellent colour fastness. Unpainted materials have a natural finish which age beautifully.

## Low maintenance

To ensure a long service life, the only maintenance that is required is an annual wipe or wash. Plastic can shrink and move when exposed to changing temperatures which can cause cracks and leaks, steel has low thermal movement minimising repair requirements. Vandal resistant products can be selected to further reinforce pipes from potential damage.

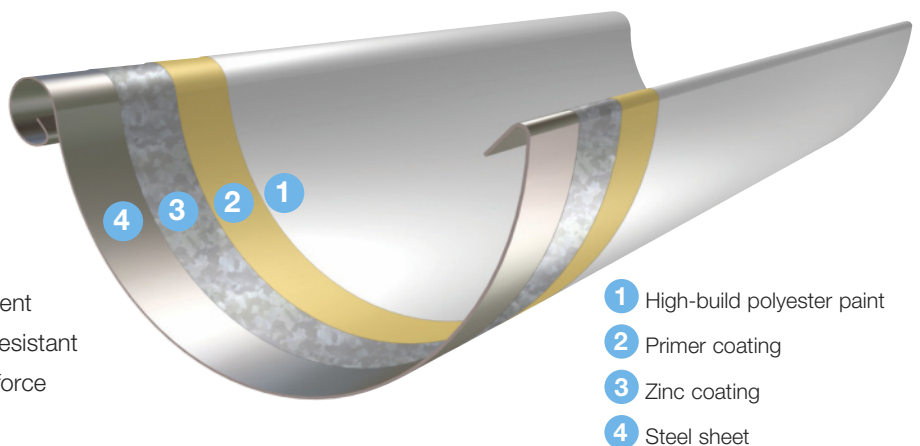



## Quick and easy to install

Smart push-fit and click-lock design features save installation time for professionals and make DIY easy. Self-sealing stopends and joints with built-in gaskets provide secure fit without sealants or welding. Lightweight 3m lengths are quicker and easier to handle than cast iron and aluminium and don't require specialist equipment on-site.

## Unlimited applications

Rainline gutters are available in either half round or rectangular profiles in a choice of 5 sizes to suit different roof sizes and local rainfall expectations. Size, shape, colour and finish options and an unrivalled range of problem-solving components provide combinations to suit classic or contemporary aesthetics for domestic or commercial properties.



## Most cost-effective option

Steel is significantly lower in cost than other metal rainwater materials and whilst being competitively priced against plastic systems, the superior life-expectancy makes it the logical choice financially. A 15 year warranty on painted Rainline systems and a 10 year warranty on Magestic galvanised systems give further peace of mind.



# Lindab Magestic

## Elite galvanisation

New technology has allowed galvanised steel to be developed using magnesium to create a stable barrier to protect zinc's porous structure against corrosion factors.

### New material technology

The zinc coating composition used for Magestic is strengthened with 3% magnesium and 3.5% aluminium. Hot dipped zinc galvanised coatings have a porous structure, magnesium creates a compact structure with high corrosion inhibition and creates a stable barrier against corrosion factors.

## Proven protection

### Highest surface protection rating of any metallic coated steel

Salt spray tests demonstrate more than 20 times the corrosion resistance of hot dipped galvanisation (ISO 9227).

Zinc Galvanised



Magnesium Zinc Galvanised



After 6 weeks salt spray test

## Self-healing

### Improved cut edge protection

A galvanised coating migrates to repair red rust on cuts and scratches. Magnesium is more anodic than zinc making the sacrificial properties of the Magestic coating more active than a zinc galvanised coating.

The self-healing effect remains on heavy gauge Magestic material above 5mm.

cut edge salt spray test – 5mm gauge steel

Zinc Galvanised



Magnesium Zinc Galvanised



## Reduced coastal corrosion

### Ultimate resistance in aggressive environments

Natural exposure tests demonstrate more than 3 times the corrosion resistance of standard galvanisation in marine environments.

Magestic corrosion rate is not influenced by the chlorine content of the environment.

## Exceptionally environmentally friendly

### Reduced zinc resource consumption

Galvanised steel is already the most environmentally friendly material used in rainwater systems, Magestic has a reduced impact on zinc resources.

Adding a minor factor of magnesium to the zinc dramatically improves performance enabling reduced coating thickness.

Less than 25% zinc run off into soils compared to hot dipped galvanised steel.

Mass loss in alkaline environment (pH11.7-5% ammonia)

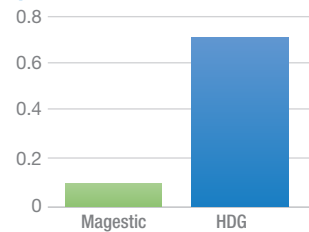

Runoff rate in C4 Maritime environment (g/m<sup>2</sup>/year)

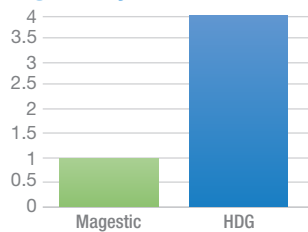

## Ages beautifully

### Natural weathering effect

Unpainted metal gutters react to the installation environment, the material will develop unevenly and adjust naturally. Magestic settles to an attractive dark grey metallic appearance within 3-5 years after installation.

Initial Look



After 6 months



After 4 years



## 10 Year Warranty

Lindab Magestic products all come with a 10 year warranty





# Beauty that lasts – painted Rainline

A choice of 10 painted colours to suit classic or contemporary aesthetics for domestic or commercial properties. High-build, scratch-resistant polyester paint is UV stable, has excellent colour fastness and is flexible which ensures that the coating isn't damaged when products are formed from the sheet steel. Painted Rainline systems are supplied with a 15 year warranty.

Colours displayed may vary from actual, NCS and RAL codes are the nearest colour match. Swatch samples can be supplied to demonstrate true colour.



**Silver Metallic**  
RAL 9006

**Anthracite Grey**  
RAL 7016  
NCS S 7502-B

**Black**  
RAL 9011  
NCS S 9000-N

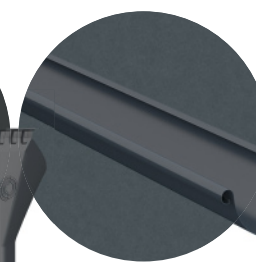
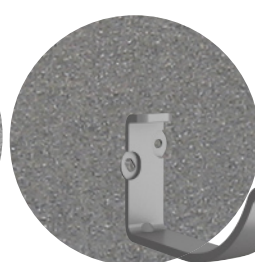

**Anthracite Metallic**  
RAL 9007

**Dark Grey**  
RAL 7043  
NCS S 7005-B20G





**Antique White**  
RAL 9002  
NCS S 1002-G50Y

**Coffee Brown**  
RAL 8019  
NCS S 8502-Y

**Dark Red**  
RAL 3009  
NCS S 5040-Y80R

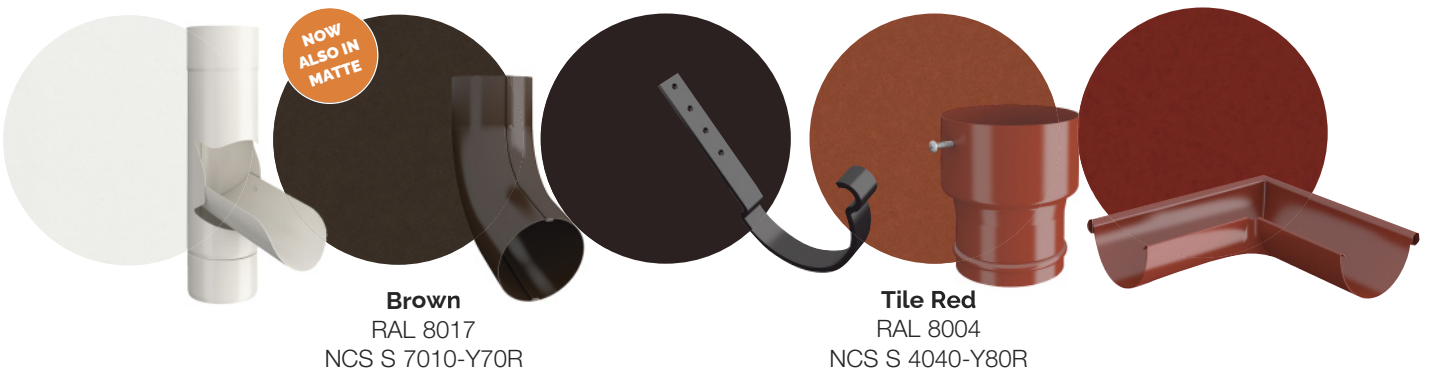



# An elegant finish – unpainted metals

Unpainted metal options provide a uniquely attractive organic aesthetic. The new improved Magestic galvanised rainwater system and supreme natural copper Rainline system will weather and adjust to the environment requiring minimum maintenance.

Unpainted finishes are not covered by Lindab's 15 year warranty. Lindab Magestic carries a 10 year warranty. For further details of Lindab warranties see [www.lindab.co.uk](http://www.lindab.co.uk)

## Magestic

Magestic – The King of Galvanised Gutters, an improved galvanised steel with a strengthened magnesium zinc alloy coating offering the highest surface protection of any metallic coated steel. Magestic settles into an attractive dark grey metallic appearance within 3-5 years after installation.

## Natural Copper

A limited range of Rainline products are available in uncoated copper. The finish is highly desirable and provides excellent corrosion resistance once it has transitioned to a greenish verdigris patina.

## Stainless Steel

Only Rainline Vandal proof products are available in a stainless steel finish. The products are made from 1.5m stainless steel plate.

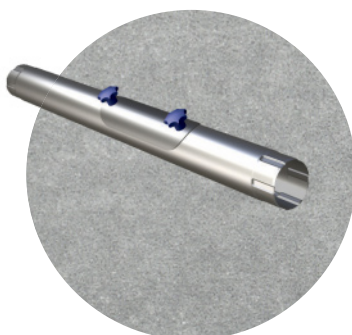

**Magestic Galvanised**



**Natural Copper**



**Stainless Steel**

# Steel rainwater system components

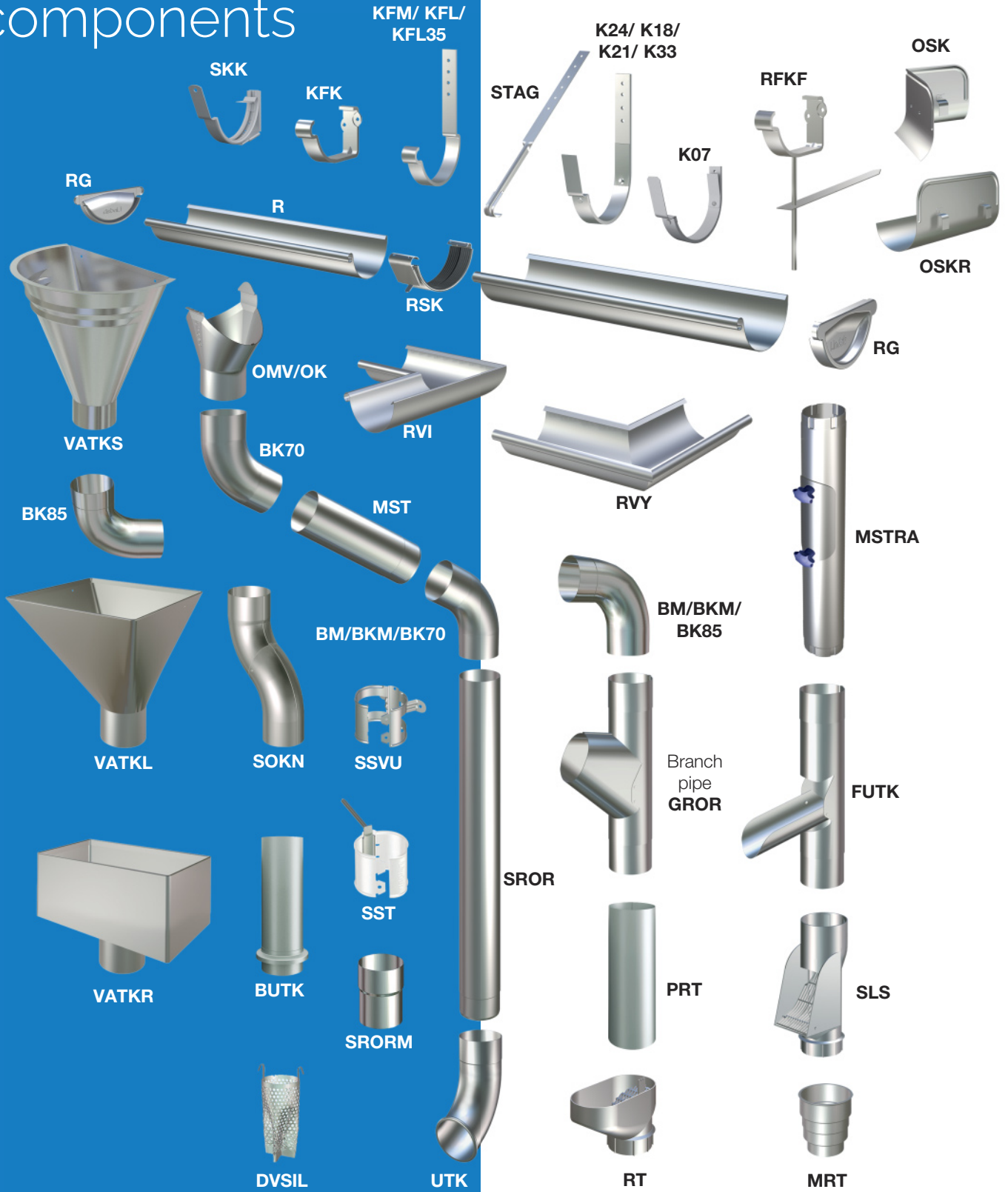



# Half Round Gutters & Fittings

## Gutters

### R – Half Round Gutter

- Roll formed 0.6 mm steel with bead stiffened front
- Can be joined using RSK gutter joint or roll joint method
- Supplied in 3 m lengths as standard

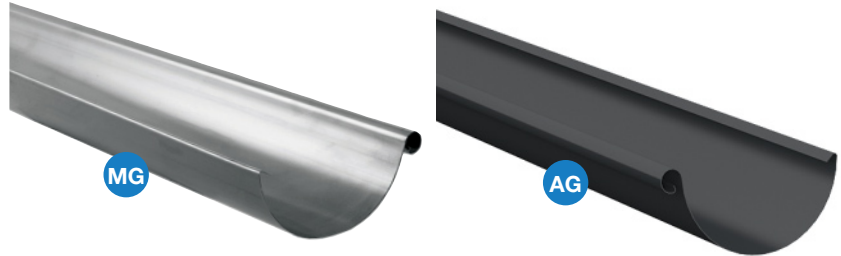

● Magestic ● ● ● ● ● ● ● ● ● ● ● ● ● ● ● Painted ● Copper

Product	Length (m)	Size (mm)	MG	Price (£)	SM	AM	AG	DG	BK	WT	BN	CB	TR	DR	MBK	MAG	MBN	Price (£)	CU	Price (£)
R3100	3	100	ⓄEx	38.89	ⓄEx	ⓄEx	ⓄEx	ⓄEx	ⓄEx	✓	✓	✓	✓	✓				44.51	✓	144.92
R3125	3	125	ⓄEx	43.76	ⓄEx	ⓄEx	ⓄEx	ⓄEx	ⓄEx	✓	✓	✓	✓	✓	✓	✓	✓	47.55	✓	161.23
R3150	3	150	ⓄEx	56.95	ⓄEx	ⓄEx	ⓄEx	ⓄEx	ⓄEx	✓	✓	✓	✓	✓	✓	✓	✓	64.80	✓	190.66
R3190	3	190	✓	77.07	✓	✓	✓	✓	✓	✓	✓	✓	✓	✓				84.43		
R2100	2	100	✓	35.79	✓	✓	✓	✓	✓	✓	✓	✓	✓	✓				39.51	✓	124.37
R2125	2	125	✓	40.97	✓	✓	✓	✓	✓	✓	✓	✓	✓	✓	✓	✓	✓	43.54	✓	130.03
R2150	2	150	✓	51.74	✓	✓	✓	✓	✓	✓	✓	✓	✓	✓	✓	✓	✓	56.99		

## Gutter Joints

### RSK – Gutter Joint

- Used to join gutters or gutter angles
- Designed with click and lock mechanism for easy installation
- Built-in EPDM rubber gasket, doesn't require sealant or screws



● Magestic ● ● ● ● ● ● ● ● ● ● ● ● ● ● ● Painted ● Copper

Product	Size (mm)	MG	Price (£)	SM	AM	AG	DG	BK	WT	BN	CB	TR	DR	MBK	MAG	MBN	Price (£)	CU	Price (£)
RSK100	100	ⓄEx	7.94	ⓄEx	ⓄEx	ⓄEx	ⓄEx	ⓄEx	✓	✓	✓	✓	✓				8.35		
RSK125	125	ⓄEx	8.07	ⓄEx	ⓄEx	ⓄEx	ⓄEx	ⓄEx	✓	✓	✓	✓	✓	✓	✓	✓	8.51		
RSK150	150	ⓄEx	8.65	ⓄEx	ⓄEx	ⓄEx	ⓄEx	ⓄEx	✓	✓	✓	✓	✓	✓	✓	✓	9.11		



Contact us to find out about our RIBA approved CPD seminars. Email: [cpd@lindab.co.uk](mailto:cpd@lindab.co.uk)

Add the colour reference to the end of the product code at point of order. e.g. R3100BK for 3 m 100 mm HR Gutter in Black finish.  
 MG = Magestic Galvanised SM = Silver Metallic AM = Anthracite Metallic AG = Anthracite Grey DG = Dark Grey  
 BK = Black WT = Antique White BN = Brown CB = Coffee Brown TR = Tile Red DR = Dark Red  
 MBK = Matte Black MAG = Matte Anthracite Grey MBN = Matte Brown CU = Natural Copper

## Stopends

### RG – Self-Locking Stop End

- Required for each end of a gutter run, universal for left and right hand
- Remove surplus ear and push-fit around gutter end
- Built-in EPDM rubber gasket, doesn't require sealant or screws



Product	Type	Size (mm)	MG	Price (£)	SM	AM	AG	DG	BK	WT	BN	CB	TR	DR	MBK	MAG	MBN	Price (£)	CU	Price (£)
RG100	LH/RH	100	⊙Ex	5.03	⊙Ex	⊙Ex	⊙Ex	⊙Ex	⊙Ex	✓	✓	✓	✓	✓				5.54		
RG125	LH/RH	125	⊙Ex	5.41	⊙Ex	⊙Ex	⊙Ex	⊙Ex	⊙Ex	✓	✓	✓	✓	✓	✓	✓	✓	5.87	✓	18.29
RG150	LH/RH	150	⊙Ex	5.80	⊙Ex	⊙Ex	⊙Ex	⊙Ex	⊙Ex	✓	✓	✓	✓	✓	✓	✓	✓	6.15	✓	20.96

### RGV/RGH/RGU – Stop End

- Required for each end of a gutter run, RGV for left hand, RGH for right hand and RGU is universal for left and right hand
- Sits inside gutter end, fitted using roll joint method
- It is recommended that sealant is used



Product	Type	Size (mm)	MG	Price (£)	SM	AM	AG	DG	BK	WT	BN	CB	TR	DR	MBK	MAG	MBN	Price (£)	CU	Price (£)
RGV190	LH	190	✓	10.98	✓	✓	✓	✓	✓	✓	✓	✓	✓	✓				11.96		
RGH190	RH	190	✓	10.98	✓	✓	✓	✓	✓	✓	✓	✓	✓	✓				11.96		
RGU100	LH/RH	100																	✓	17.45

Images for illustrative purposes only. Further details of the colour range can be found on page 8

Keep up-to-date  
with Rainline and  
Ventilation events  
and offers – follow  
us on Twitter  
**@UK\_Lindab**



# Half Round Gutters & Fittings

## Gutter Angles

### RVI – Internal Gutter Angle

- Required for roof features such as recesses or extensions, require 2 RSK gutter joints
- Universal for left and right hand, available to fit 90° or 135° corners or other angles on request
- Angles may be pressed or fabricated, finish may vary



MG 90°



AG 135°



Product	Angle	Size (mm)	MG	Price (£)	SM	AM	AG	DG	BK	WT	BN	CB	TR	DR	MBK	MAG	MBN	Price (£)	CU	Price (£)
<b>RVIS100</b>	90°	100	ⓄEx	40.85	ⓄEx	ⓄEx	ⓄEx	ⓄEx	ⓄEx	✓	✓	✓	✓	✓				46.87	✓	92.63
<b>RVIS125</b>	90°	125	ⓄEx	42.45	ⓄEx	ⓄEx	ⓄEx	ⓄEx	ⓄEx	✓	✓	✓	✓	✓	✓	✓	✓	47.97	✓	99.95
<b>RVIS150</b>	90°	150	ⓄEx	49.35	ⓄEx	ⓄEx	ⓄEx	ⓄEx	ⓄEx	✓	✓	✓	✓	✓	✓	✓	✓	57.45	✓	116.81
<b>RVIO100</b>	135°	100	✓	61.28	✓	✓	✓	✓	✓	✓	✓	✓	✓	✓				70.33		
<b>RVIO125</b>	135°	125	ⓄEx	63.66	✓	✓	✓	✓	ⓄEx	✓	✓	✓	✓	✓	✓	✓	✓	71.98		
<b>RVIO150</b>	135°	150	✓	74.04	✓	✓	✓	✓	✓	✓	✓	✓	✓	✓	✓	✓	✓	86.18		

### RVY – External Gutter Angle

- Required to continue gutter line around a corner, require 2 RSK gutter joints
- Universal for left and right hand, available to fit 90° or 135° corners or other angles on request
- Angles may be pressed or fabricated, finish may vary



MG 90°



AG 135°



Product	Angle	Size (mm)	MG	Price (£)	SM	AM	AG	DG	BK	WT	BN	CB	TR	DR	MBK	MAG	MBN	Price (£)	CU	Price (£)
<b>RVYS100</b>	90°	100	ⓄEx	40.85	ⓄEx	ⓄEx	ⓄEx	ⓄEx	ⓄEx	✓	✓	✓	✓	✓				46.87	✓	92.63
<b>RVYS125</b>	90°	125	ⓄEx	42.45	ⓄEx	ⓄEx	ⓄEx	ⓄEx	ⓄEx	✓	✓	✓	✓	✓	✓	✓	✓	47.97	✓	99.95
<b>RVYS150</b>	90°	150	ⓄEx	49.35	ⓄEx	ⓄEx	ⓄEx	ⓄEx	ⓄEx	✓	✓	✓	✓	✓	✓	✓	✓	57.45	✓	116.81
<b>RVYO100</b>	135°	100	✓	61.28	✓	✓	✓	✓	✓	✓	✓	✓	✓	✓				70.33		
<b>RVYO125</b>	135°	125	ⓄEx	63.66	✓	✓	✓	✓	ⓄEx	✓	✓	✓	✓	✓	✓	✓	✓	71.98		
<b>RVYO150</b>	135°	150	✓	74.04	✓	✓	✓	✓	✓	✓	✓	✓	✓	✓	✓	✓	✓	86.18		

Add the colour reference to the end of the product code at point of order. e.g. R3100BK for 3 m 100 mm HR Gutter in Black finish.

**MG** = Magestic Galvanised **SM** = Silver Metallic **AM** = Anthracite Metallic **AG** = Anthracite Grey **DG** = Dark Grey

**BK** = Black **WT** = Antique White **BN** = Brown **CB** = Coffee Brown **TR** = Tile Red **DR** = Dark Red

**MBK** = Matte Black **MAG** = Matte Anthracite Grey **MBN** = Matte Brown **CU** = Natural Copper

## Gutter Outlets

### OMV/OK – Gutter Outlet

- Can be positioned at any point along the gutter to connect to a downpipe
- Requires hole to be created in the gutter
- Uses flex-fit flaps to secure, OMV has click-fit for easy installation



Product	Outlet (mm)	Size (mm)	MG	Price (£)	SM	AM	AG	DG	BK	WT	BN	CB	TR	DR	MBK	MAG	MBN	Price (£)	CU	Price (£)
OMVA100	75	100	ⓄEx	15.44	ⓄEx	ⓄEx	ⓄEx	ⓄEx	ⓄEx	✓	✓	✓	✓	✓				16.23		
OKA100	75	100																	✓	55.54
OMVA125	75	125	ⓄEx	16.30	ⓄEx	ⓄEx	ⓄEx	ⓄEx	ⓄEx	✓	✓	✓	✓	✓				17.16		
OKA125	75	125																	✓	59.96
OKA150	75	150	ⓄEx	19.03	ⓄEx	ⓄEx	ⓄEx	ⓄEx	ⓄEx	✓	✓	✓	✓	✓				20.34	✓	64.44
OMVB100	87	100	ⓄEx	15.44	ⓄEx	ⓄEx	ⓄEx	ⓄEx	ⓄEx	✓	✓	✓	✓	✓				16.23		
OKB100	87	100																	✓	55.54
OMVB125	87	125	ⓄEx	16.30	ⓄEx	ⓄEx	ⓄEx	ⓄEx	ⓄEx	✓	✓	✓	✓	✓	✓	✓	✓	17.16		
OKB125	87	125																	✓	59.96
OMVB150	87	150	ⓄEx	19.03	ⓄEx	ⓄEx	ⓄEx	ⓄEx	ⓄEx	✓	✓	✓	✓	✓	✓	✓	✓	20.34		
OKB150	87	150																	✓	64.44
OMVC125	100	125	ⓄEx	16.30	ⓄEx	ⓄEx	ⓄEx	ⓄEx	ⓄEx	✓	✓	✓	✓	✓	✓	✓	✓	17.16		
OKC125	100	125																	✓	59.96
OMVC150	100	150	ⓄEx	19.03	ⓄEx	ⓄEx	ⓄEx	ⓄEx	ⓄEx	✓	✓	✓	✓	✓	✓	✓	✓	20.34		
OKC150	100	150																	✓	64.44
OKC190	100	190	✓	35.49	✓	✓	✓	✓	✓	✓	✓	✓	✓	✓				40.78		
OMVD150	120	150	✓	19.03	✓	✓	✓	✓	✓	✓	✓	✓	✓	✓				20.34		
OKD150	120	150																20.34	✓	64.44
OKD190	120	190	✓	35.49	✓	✓	✓	✓	✓	✓	✓	✓	✓	✓				40.78		

### Request a colour sample

For a true to life representation of Rainline colours, credit card sized coated steel sample swatches are available. Email a request for your colour of choice to [rainline@lindab.co.uk](mailto:rainline@lindab.co.uk)

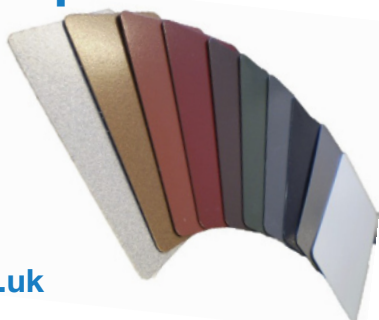

Images for illustrative purposes only. Further details of the colour range can be found on page 8



# Half Round Gutters & Fittings

## Fascia Brackets

### KFK – Fascia Bracket

- Solid 5 mm steel bracket used to secure gutters to fascia boards
- Recommended 600 mm spacing, should be installed to create fall of 10 mm per 3 m run
- Standard screw hole and oval hole designed to allow precise adjustments

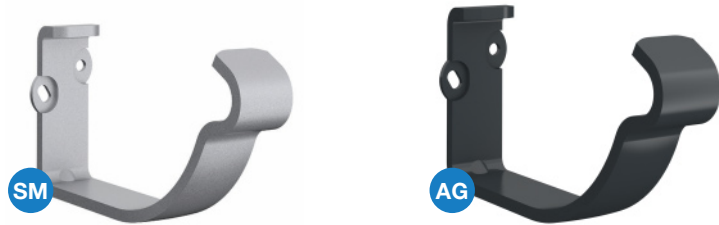

Product	Size (mm)	MG	Price (£)	SM	AM	AG	DG	BK	WT	BN	CB	TR	DR	MBK	MAG	MBN	Price (£)	CU	Price (£)
KFK100	100	ⓄEx	5.43	ⓄEx	ⓄEx	ⓄEx	ⓄEx	ⓄEx	✓	✓	✓	✓	✓				5.65		
KFK125	125	ⓄEx	5.80	ⓄEx	ⓄEx	ⓄEx	ⓄEx	ⓄEx	✓	✓	✓	✓	✓	✓	✓	✓	5.87		
KFK150	150	ⓄEx	5.89	ⓄEx	ⓄEx	ⓄEx	ⓄEx	ⓄEx	✓	✓	✓	✓	✓	✓	✓	✓	6.00		

### K07/K24 – Flex-Fit Fascia Bracket

- Uses flexible clips to hold the gutter in place
- Recommended 600 mm spacing, should be installed to create fall of 10 mm per 3 m run
- 70 mm bracket with 2 fixing holes and 240 mm extended bracket with 4 screw holes to secure larger gutters



Product	Length (m)	Size (mm)	MG	Price (£)	SM	AM	AG	DG	BK	WT	BN	CB	TR	DR	MBK	MAG	MBN	Price (£)	CU	Price (£)
K07100	70	100	✓	7.03	✓	✓	✓	✓	✓	✓	✓	✓	✓	✓				7.99	✓	26.06
K07125	70	125	✓	7.89	✓	✓	✓	✓	✓	✓	✓	✓	✓	✓	✓	✓	✓	8.57	✓	28.94
K07150	70	150	✓	10.24	✓	✓	✓	✓	✓	✓	✓	✓	✓	✓	✓	✓	✓	11.67	✓	31.90
K07190	70	190	✓	13.81	✓	✓	✓	✓	✓	✓	✓	✓	✓	✓				15.19		
K24190	240	190			✓	✓	✓	✓	✓	✓	✓	✓	✓	✓				14.09		

### SKK – Adjustable Fascia Bracket

- Locks in place at 7, 14, 18, 22, 27, 38 or 45° angle for use on angled fascia boards
- Recommended 600 mm spacing, should be installed to create fall of 10 mm per 3 m run
- Flexible clips hold the gutter securely in place



Product	Size (mm)	MG	Price (£)	SM	AM	AG	DG	BK	WT	BN	CB	TR	DR	MBK	MAG	MBN	Price (£)	CU	Price (£)
SKK100	100	ⓄEx	5.13	ⓄEx	ⓄEx	ⓄEx	ⓄEx	ⓄEx	✓	✓	✓	✓	✓				5.65		
SKK125	125	ⓄEx	5.34	ⓄEx	ⓄEx	ⓄEx	ⓄEx	ⓄEx	✓	✓	✓	✓	✓	✓	✓	✓	5.87		
SKK150	150	✓	5.45	✓	✓	✓	✓	✓	✓	✓	✓	✓	✓	✓	✓	✓	6.00		

Add the colour reference to the end of the product code at point of order. e.g. R3100BK for 3 m 100 mm HR Gutter in Black finish.

MG = Magestic Galvanised SM = Silver Metallic AM = Anthracite Metallic AG = Anthracite Grey DG = Dark Grey

BK = Black WT = Antique White BN = Brown CB = Coffee Brown TR = Tile Red DR = Dark Red

MBK = Matte Black MAG = Matte Anthracite Grey MBN = Matte Brown CU = Natural Copper



## Rafter Brackets

### KFM/KFL/KFL35 – Rafter Bracket

- Solid 5 mm steel bracket with 4 fixing holes, used to secure gutters to roof rafters
- Recommended 600 mm spacing, should be installed to create fall of 10 mm per 3 m run
- Can be bent to required angle using KBO bracket bender or supplied bent or twisted to suit for an additional charge of £2 per bracket

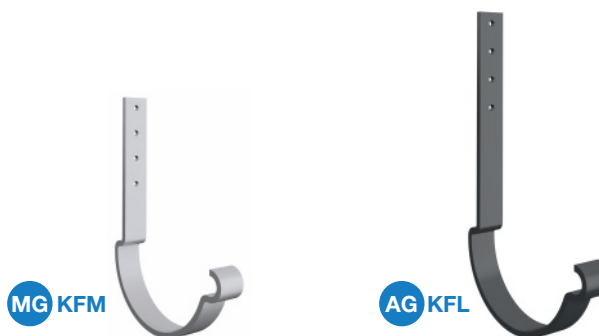

Product	Length (m)	Size (mm)	MG	Price (£)	SM	AM	AG	DG	BK	WT	BN	CB	TR	DR	MBK	MAG	MBN	Price (£)	CU	Price (£)
KFM125	150	125			✓	✓	✓	✓	✓	✓	✓	✓	✓	✓	✓	✓	✓	7.46		
KFM150	150	150			✓	✓	✓	✓	✓	✓	✓	✓	✓	✓	✓	✓	✓	7.94		
KFL100	200	100	ⓄEx	7.05	ⓄEx	ⓄEx	ⓄEx	ⓄEx	ⓄEx	✓	✓	✓	✓	✓				7.44		
KFL125	200	125	ⓄEx	7.36	ⓄEx	ⓄEx	ⓄEx	ⓄEx	ⓄEx	✓	✓	✓	✓	✓	✓	✓	✓	7.74		
KFL150	200	150	ⓄEx	7.94	ⓄEx	ⓄEx	ⓄEx	ⓄEx	ⓄEx	✓	✓	✓	✓	✓	✓	✓	✓	8.35		
KFL35125	350	125			ⓄEx	ⓄEx	ⓄEx	ⓄEx	ⓄEx	✓	✓	✓	✓	✓	✓	✓	✓	10.29		
KFL35150	350	150			✓	✓	✓	✓	✓	✓	✓	✓	✓	✓	✓	✓	✓	11.10		

### K18/K21/K33 – Flex-Fit Rafter Bracket

- Solid 5 mm steel bracket with flexible clips to hold the gutter in place and 4 fixing holes to secure to roof rafters
- Recommended 600 mm spacing, should be installed to create fall of 10 mm per 3 m run
- Can be bent to required angle using KBO bracket bender or supplied bent or twisted to suit for an additional charge of £2 per bracket



Product	Length (m)	Size (mm)	MG	Price (£)	SM	AM	AG	DG	BK	WT	BN	CB	TR	DR	MBK	MAG	MBN	Price (£)	CU	Price (£)
K18100	180	100	✓	7.75	✓	✓	✓	✓	✓	✓	✓	✓	✓	✓				8.19	✓	30.73
K18125	180	125	✓	8.10	✓	✓	✓	✓	✓	✓	✓	✓	✓	✓	✓	✓	✓	8.54	✓	37.54
K18150	180	150	✓	8.41	✓	✓	✓	✓	✓	✓	✓	✓	✓	✓	✓	✓	✓	8.88	✓	41.00
K21125	210	125	ⓄEx	8.41	✓	✓	✓	✓	✓	✓	✓	✓	✓	✓	✓	✓	✓	8.88	✓	40.96
K21150	210	150	ⓄEx	9.19	✓	✓	✓	✓	✓	✓	✓	✓	✓	✓	✓	✓	✓	9.67	✓	44.44
K33150	330	150	✓	12.95	✓	✓	✓	✓	✓	✓	✓	✓	✓	✓	✓	✓	✓	13.62		
K33190	330	190	✓	12.82	✓	✓	✓	✓	✓	✓	✓	✓	✓	✓				14.09		

Images for illustrative purposes only. Further details of the colour range can be found on page 8

Visit our website for the latest product updates:

[www.lindabprofile.co.uk](http://www.lindabprofile.co.uk)





# Half Round Gutters & Fittings

## KRT- Side-Fix Rafter Bracket

- Bent to 38 degrees and twisted for easy side-fixing to rafters
- Recommended 600 mm spacing, should be installed to create fall of 10 mm per 3 m run
- Flexible clips hold the gutter securely in place

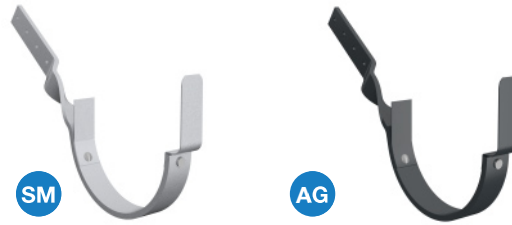

Product	Size (mm)	MG	Price (£)	SM	AM	AG	DG	BK	WT	BN	CB	TR	DR	MBK	MAG	MBN	Price (£)	CU	Price (£)
KRT125	125	ⓄEx	8.53	ⓄEx	ⓄEx	ⓄEx	ⓄEx	ⓄEx	✓	✓	✓	✓	✓				8.84		
KRT150	150	ⓄEx	8.72	ⓄEx	ⓄEx	ⓄEx	ⓄEx	ⓄEx	✓	✓	✓	✓	✓				9.12		

## Rise & Fall Brackets

### RFKF - Rise & Fall Bracket

- 300 mm solid spike used for drive-in fixing to wall
- Recommended 600 mm spacing, should be installed to create fall of 10 mm per 3 m run
- 250 mm threaded bar allows adjustment of gutter level

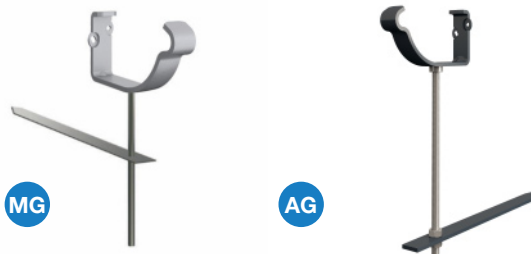

Product	Size (mm)	MG	Price (£)	SM	AM	AG	DG	BK	WT	BN	CB	TR	DR	MBK	MAG	MBN	Price (£)	CU	Price (£)
RFKF100	100	ⓄEx	19.81	ⓄEx	ⓄEx	ⓄEx	ⓄEx	ⓄEx	✓	✓	✓	✓	✓				21.79		
RFKF125	125	ⓄEx	21.54	ⓄEx	ⓄEx	ⓄEx	ⓄEx	ⓄEx	✓	✓	✓	✓	✓				23.71		
RFKF150	150	✓	23.18	✓	✓	✓	✓	✓	✓	✓	✓	✓	✓				24.40		

# Building Information Modelling

Lindab can offer collaborative support for architects and specifiers by providing Building Information Modelling components for our rainwater systems.

The comprehensive file package includes gutter systems and downpipe systems with complete specification information. Components in 2D and 3D have support on item level, 46 different gutter types and accessory families from the gutter down to the foot of the pipe can be used to correctly build up a system and add parameters to the Revit schedule.

The BIM objects are designed for use with Autodesk Revit 2016.



Add the colour reference to the end of the product code at point of order. e.g. R3100BK for 3 m 100 mm HR Gutter in Black finish.

**MG** = Magestic Galvanised **SM** = Silver Metallic **AM** = Anthracite Metallic **AG** = Anthracite Grey **DG** = Dark Grey  
**BK** = Black **WT** = Antique White **BN** = Brown **CB** = Coffee Brown **TR** = Tile Red **DR** = Dark Red  
**MBK** = Matte Black **MAG** = Matte Anthracite Grey **MBN** = Matte Brown **CU** = Natural Copper

## Radius Gutter Brackets

### RSKR – Radius Gutter Bracket

- Combined gutter joint and fascia bracket used for fixing gutter sections to fit a curved roofline
- 4° alignment deviation tolerance at each joint
- Built-in EPDM rubber gasket, doesn't require sealant



Product	Size (mm)	Magestic															Painted		Copper
		MG	Price (£)	SM	AM	AG	DG	BK	WT	BN	CB	TR	DR	MBK	MAG	MBN	Price (£)	CU	Price (£)
<b>RSKR125</b>	125			ⓄEx	ⓄEx	ⓄEx	ⓄEx	ⓄEx	✓	✓	✓	✓	✓				12.72		

## Gutter Accessories

### OSK/OSKR – Overflow Protector

- Used to reduce gutter overflow at high flow sections
- Can be easily retro-fitted to existing system, hooks over gutter bead to secure
- OSKR for straight sections and OSK for corner protection

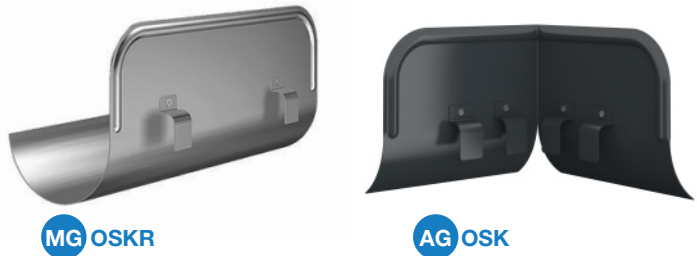

Product	Type	Size (mm)	Magestic															Painted		Copper		
			MG	Price (£)	SM	AM	AG	DG	BK	WT	BN	CB	TR	DR	MBK	MAG	MBN	Price (£)	CU	Price (£)		
<b>OSKR125</b>	Straight	125	✓	41.39	✓	✓	✓	✓	✓	✓	✓	✓	✓	✓	✓	✓	✓	✓	✓	41.58		
<b>OSKR150</b>	Straight	150	✓	43.29	✓	✓	✓	✓	✓	✓	✓	✓	✓	✓	✓	✓	✓	✓	✓	45.60		
<b>OSK</b>	Corner		✓	41.39	✓	✓	✓	✓	✓	✓	✓	✓	✓	✓	✓	✓	✓	✓	✓	41.58		

### STAG – Stay Strap

- Can provide added stability to gutter in areas subject to adverse weather conditions
- Clips to rolled front edge of gutter
- 5 screw holes enable secure fixing to the roof



Product	Magestic		Magestic											Painted		Copper		
	MG	Price (£)	SM	AM	AG	DG	BK	WT	BN	CB	TR	DR	MBK	MAG	MBN	Price (£)	CU	Price (£)
<b>STAG</b>	✓	4.03	✓	✓	✓	✓	✓	✓	✓	✓	✓	✓	✓	✓	✓	4.16		

Images for illustrative purposes only. Further details of the colour range can be found on page 8



# Rectangular Gutters & Fittings

## Gutters

### RTRA – Rectangular Gutter

- 0.6 mm steel box gutter with roll-formed bead stiffened front
- Can be joined using RTSK gutter joint or roll joint method
- Supplied in 3 m lengths as standard

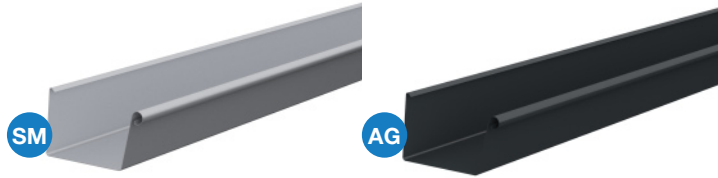

Product	Length (m)	Size (mm)	MG	Price (£)	SM	AM	AG	DG	BK	WT	BN	CB	TR	DR	MBK	MAG	MBN	Price (£)	CU	Price (£)
RTRA3140	3	140	ⓄEx	75.67	ⓄEx	ⓄEx	ⓄEx	ⓄEx	ⓄEx	✓	✓	✓	✓	✓				86.47	✓	272.22

## Gutter Joints

### RTSK – Rectangular Gutter Joint

- Used to join gutters or gutter angles
- Designed with click and lock mechanism for easy installation
- Built-in EPDM rubber gasket, doesn't require sealant or screws

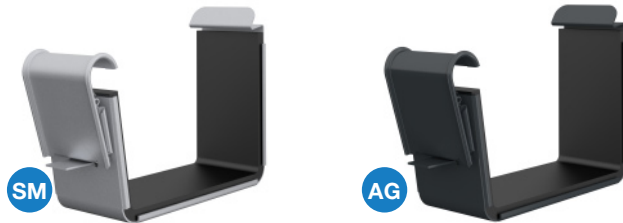

Product	Size (mm)	MG	Price (£)	SM	AM	AG	DG	BK	WT	BN	CB	TR	DR	MBK	MAG	MBN	Price (£)	CU	Price (£)
RTSK140	140	ⓄEx	18.43	ⓄEx	ⓄEx	ⓄEx	ⓄEx	ⓄEx	✓	✓	✓	✓	✓				18.43		

## Stop Ends

### RTGV/RTGH – Rectangular Stop End

- Required for each end of a gutter run, RTGV for left and RTGH for right hand
- Sits inside gutter end, fitted using roll joint method
- It is recommended that sealant is used



Product	Type	Size (mm)	MG	Price (£)	SM	AM	AG	DG	BK	WT	BN	CB	TR	DR	MBK	MAG	MBN	Price (£)	CU	Price (£)
RTGV140	LH	140	ⓄEx	18.33	ⓄEx	ⓄEx	ⓄEx	ⓄEx	ⓄEx	✓	✓	✓	✓	✓				20.15	✓	63.43
RTGH140	RH	140	ⓄEx	18.33	ⓄEx	ⓄEx	ⓄEx	ⓄEx	ⓄEx	✓	✓	✓	✓	✓				20.15	✓	63.43

Add the colour reference to the end of the product code at point of order. e.g. R3100BK for 3 m 100 mm HR Gutter in Black finish.

**MG** = Magestic Galvanised **SM** = Silver Metallic **AM** = Anthracite Metallic **AG** = Anthracite Grey **DG** = Dark Grey

**BK** = Black **WT** = Antique White **BN** = Brown **CB** = Coffee Brown **TR** = Tile Red **DR** = Dark Red

**MBK** = Matte Black **MAG** = Matte Anthracite Grey **MBN** = Matte Brown **CU** = Natural Copper

## Gutter Angles

### RTVI – Internal Rectangular Gutter Angle

- Required for roof features such as recesses or extensions, require 2 RTSK gutter joints
- Universal for left and right hand, available to fit 90° corners or other angles on request
- Angles may be pressed or fabricated, finish may vary

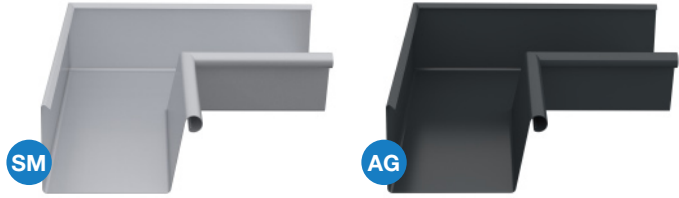

Product	Angle	Size (mm)	MG	Price (£)	SM	AM	AG	DG	BK	WT	BN	CB	TR	DR	MBK	MAG	MBN	Price (£)	CU	Price (£)
RTVIS140	90°	140	ⓄEx	90.99	ⓄEx	ⓄEx	ⓄEx	ⓄEx	ⓄEx	✓	✓	✓	✓	✓				104.41		

### RTVY – External Rectangular Gutter Angle

- Required to continue gutter line around a corner, require 2 RTSK gutter joints
- Universal for left and right hand, available to fit 90° corners or other angles on request
- Angles may be pressed or fabricated, finish may vary

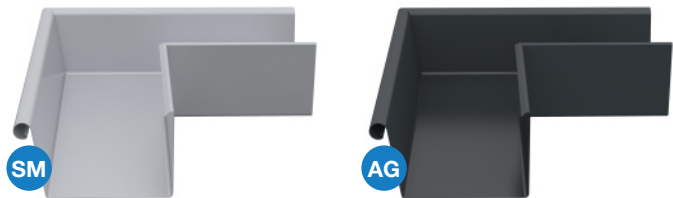

Product	Angle	Size (mm)	MG	Price (£)	SM	AM	AG	DG	BK	WT	BN	CB	TR	DR	MBK	MAG	MBN	Price (£)	CU	Price (£)
RTVYS140	90°	140	ⓄEx	90.99	ⓄEx	ⓄEx	ⓄEx	ⓄEx	ⓄEx	✓	✓	✓	✓	✓				104.41		

## Gutter Outlets

### RTOK – Rectangular Gutter Outlet

- Can be positioned at any point along the gutter to connect to a downpipe
- Requires hole to be created in the gutter
- Uses flex-fit flaps to secure

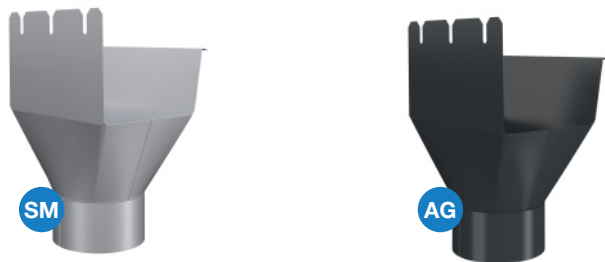

Product	Outlet (mm)	Size (mm)	MG	Price (£)	SM	AM	AG	DG	BK	WT	BN	CB	TR	DR	MBK	MAG	MBN	Price (£)	CU	Price (£)
RTOKA140	75	140	ⓄEx	45.28	ⓄEx	ⓄEx	ⓄEx	ⓄEx	ⓄEx	✓	✓	✓	✓	✓				47.53	✓	149.62
RTOKB140	87	140	ⓄEx	45.28	ⓄEx	ⓄEx	ⓄEx	ⓄEx	ⓄEx	✓	✓	✓	✓	✓				47.53	✓	149.62
RTOKC140	100	140	ⓄEx	45.28	ⓄEx	ⓄEx	ⓄEx	ⓄEx	ⓄEx	✓	✓	✓	✓	✓				47.53	✓	149.62
RTOKD140	120	140					✓			✓		✓						47.53		

Images for illustrative purposes only. Further details of the colour range can be found on page 8



# Rectangular Gutters & Fittings

## Fascia Brackets

### RTK07 – Rectangular Flex-Fit Fascia Bracket

- Uses flexible clips to hold the gutter in place
- Recommended 600 mm spacing, should be installed to create fall of 10 mm per 3 m run
- 70 mm bracket with 2 fixing holes



Product	Length (m)	Size (mm)	MG	Price (£)	SM	AM	AG	DG	BK	WT	BN	CB	TR	DR	MBK	MAG	MBN	Price (£)	CU	Price (£)
RTK07140	70	140	ⓄEx	10.13	✓	✓	✓	✓	✓	✓	✓	✓	✓	✓				10.22	✓	32.21

### RTKFK – Rectangular Fascia Bracket

- Solid 5 mm steel bracket used to secure gutters to fascia boards
- Recommended 600 mm spacing, should be installed to create fall of 10 mm per 3 m run
- Standard screw hole and oval hole designed to allow precise adjustments

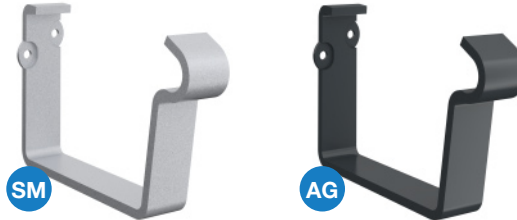

Product	Length (m)	Size (mm)	MG	Price (£)	SM	AM	AG	DG	BK	WT	BN	CB	TR	DR	MBK	MAG	MBN	Price (£)	CU	Price (£)
RTKFK140	70	140			ⓄEx	ⓄEx	ⓄEx	ⓄEx	ⓄEx	✓	✓	✓	✓	✓				10.22	✓	32.21

## Rafter Brackets

### RTK21 – Rectangular Flex-Fit Rafter Bracket

- Solid 5 mm steel bracket with flexible clips to hold the gutter in place and 4 fixing holes to secure to roof rafters
- Recommended 600 mm spacing, should be installed to create fall of 10 mm per 3 m run
- Can be bent to required angle using KBO bracket bender or supplied bent or twisted to suit for an additional charge of £2 per bracket



Product	Length (m)	Size (mm)	MG	Price (£)	SM	AM	AG	DG	BK	WT	BN	CB	TR	DR	MBK	MAG	MBN	Price (£)	CU	Price (£)
RTK21140	210	140	ⓄEx	11.74	ⓄEx	ⓄEx	ⓄEx	ⓄEx	ⓄEx	✓	✓	✓	✓	✓				12.44	✓	39.18

Add the colour reference to the end of the product code at point of order. e.g. R3100BK for 3 m 100 mm HR Gutter in Black finish.

MG = Magestic Galvanised SM = Silver Metallic AM = Anthracite Metallic AG = Anthracite Grey DG = Dark Grey

BK = Black WT = Antique White BN = Brown CB = Coffee Brown TR = Tile Red DR = Dark Red

MBK = Matte Black MAG = Matte Anthracite Grey MBN = Matte Brown CU = Natural Copper

# Pipes & Fittings

## Pipes

### SROR – Downpipe

- Roll-formed 0.6 mm steel with solid seam, 0.7 mm steel for 120 mm pipes
- Hidden male/female joint, sockets are not required
- Supplied in 3 m lengths as standard



Product	Length (m)	Size (mm)	Magestic															Painted			Copper	
			MG	Price (£)	SM	AM	AG	DG	BK	WT	BN	CB	TR	DR	MBK	MAG	MBN	Price (£)	CU	Price (£)		
SROR375	3	75	ⓄEx	45.86	ⓄEx	ⓄEx	ⓄEx	ⓄEx	ⓄEx	✓	✓	✓	✓	✓				53.36	✓	206.93		
SROR387	3	87	ⓄEx	53.49	ⓄEx	ⓄEx	ⓄEx	ⓄEx	ⓄEx	✓	✓	✓	✓	✓	✓	✓	✓	57.90	✓	235.20		
SROR3100	3	100	ⓄEx	58.70	ⓄEx	ⓄEx	ⓄEx	ⓄEx	ⓄEx	✓	✓	✓	✓	✓	✓	✓	✓	69.39	✓	262.70		
SROR3120	3	120	✓	78.91	✓	✓	✓	✓	✓	✓	✓	✓	✓	✓				89.19	✓	309.49		
SROR2575	2.5	75	✓	42.79	✓	✓	✓	✓	✓	✓	✓	✓	✓	✓				50.81	✓	159.92		
SROR2587	2.5	87	✓	49.13	✓	✓	✓	✓	✓	✓	✓	✓	✓	✓	✓	✓	✓	55.14	✓	173.58		
SROR25100	2.5	100	✓	50.81	✓	✓	✓	✓	✓	✓	✓	✓	✓	✓	✓	✓	✓	66.09	✓	208.04		
SROR25120	2.5	120	✓	68.32	✓	✓	✓	✓	✓	✓	✓	✓	✓	✓				84.95				
SROR175	1	75	✓	37.73	✓	✓	✓	✓	✓	✓	✓	✓	✓	✓				47.79	✓	158.48		
SROR187	1	87	✓	46.85	✓	✓	✓	✓	✓	✓	✓	✓	✓	✓	✓	✓	✓	51.88	✓	191.54		
SROR1100	1	100	✓	47.50	✓	✓	✓	✓	✓	✓	✓	✓	✓	✓	✓	✓	✓	62.15	✓	210.34		
SROR1120	1	120	✓	62.28	✓	✓	✓	✓	✓	✓	✓	✓	✓	✓				79.91	✓	245.74		

### MST – Intermediate Pipe

- Typically used to make an offset with >200 mm projection
- 1 m option supplied with double spigot male ends, 0.5 m option supplied with male/female ends
- Can be cut to make two shorter pipes

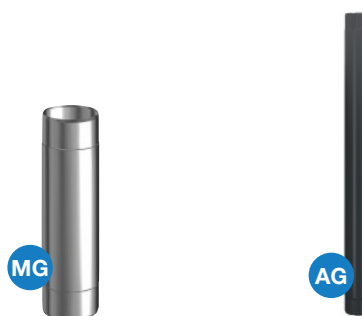

Product	Length (m)	Size (mm)	Magestic															Painted			Copper	
			MG	Price (£)	SM	AM	AG	DG	BK	WT	BN	CB	TR	DR	MBK	MAG	MBN	Price (£)	CU	Price (£)		
MST175	1	75	ⓄEx	18.58	ⓄEx	ⓄEx	ⓄEx	ⓄEx	ⓄEx	✓	✓	✓	✓	✓				20.96				
MST187	1	87	ⓄEx	21.48	ⓄEx	ⓄEx	ⓄEx	ⓄEx	ⓄEx	✓	✓	✓	✓	✓	✓	✓	✓	22.52				
MST1100	1	100	ⓄEx	23.67	ⓄEx	ⓄEx	ⓄEx	ⓄEx	ⓄEx	✓	✓	✓	✓	✓	✓	✓	✓	26.73	✓	130.48		
MST1120	1	120	✓	31.65	✓	✓	✓	✓	✓	✓	✓	✓	✓	✓				35.42				
MST0575	0.5	75	ⓄEx	17.68	✓	✓	✓	✓	ⓄEx	✓	✓		✓	✓				19.94				
MST0587	0.5	87	✓	20.41	✓	✓	✓	✓	✓	✓	✓		✓	✓				21.41				

Images for illustrative purposes only. Further details of the colour range can be found on page 8



# Pipes & Fittings

## MSTRA – Rod Access Pipe

- Provides access for maintenance rod to enable pipe blockages to be cleared
- Supplied with double spigot male ends, second spigot can be cut off if not required
- Access door is unpainted galvanised steel with coloured plastic handles



Product	Length (m)	Size (mm)	MG	Price (£)	SM	AM	AG	DG	BK	WT	BN	CB	TR	DR	MBK	MAG	MBN	Price (£)	CU	Price (£)
MSTRA75	1	75	ⓄEx	104.63	ⓄEx	ⓄEx	ⓄEx	ⓄEx	ⓄEx	✓	✓	✓	✓	✓				110.14	✓	346.69
MSTRA87	1	87	ⓄEx	105.58	ⓄEx	ⓄEx	ⓄEx	ⓄEx	ⓄEx	✓	✓	✓	✓	✓	✓	✓	✓	111.11	✓	349.80
MSTRA100	1	100	ⓄEx	113.59	ⓄEx	ⓄEx	ⓄEx	ⓄEx	ⓄEx	✓	✓	✓	✓	✓	✓	✓	✓	119.58	✓	363.86

## PRT – Sliding Pipe

- Fits around the outside of the pipe, easily slides up for access
- Used with an RT Drain Trap
- Provides access for maintenance rod to enable pipe blockages to be cleared

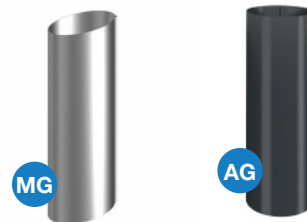

Product	Size (mm)	MG	Price (£)	SM	AM	AG	DG	BK	WT	BN	CB	TR	DR	MBK	MAG	MBN	Price (£)	CU	Price (£)
PRT75	75	✓	15.89	✓	✓	✓	✓	✓	✓	✓		✓	✓				17.79		
PRT87	87	✓	16.49	✓	✓	✓	✓	✓	✓	✓	✓	✓	✓	✓	✓	✓	18.79		
PRT100	100	✓	18.78	✓	✓	✓	✓	✓	✓	✓		✓	✓	✓	✓	✓	20.50		

## Specification and Project Estimation

The Lindab Profile Systems team can assist with specification generation and quote estimation. A take-off service is available for creating bill of material lists from architectural drawings.



To find out more about technical support services contact: 0121 585 2788



Add the colour reference to the end of the product code at point of order. e.g. R3100BK for 3 m 100 mm HR Gutter in Black finish.  
**MG** = Magestic Galvanised **SM** = Silver Metallic **AM** = Anthracite Metallic **AG** = Anthracite Grey **DG** = Dark Grey  
**BK** = Black **WT** = Antique White **BN** = Brown **CB** = Coffee Brown **TR** = Tile Red **DR** = Dark Red  
**MBK** = Matte Black **MAG** = Matte Anthracite Grey **MBN** = Matte Brown **CU** = Natural Copper



## Pipe Brackets

### SSVU – Universal Pipe Bracket

- Allows screw-to-wall pipe fixing or can be used with SST spike for drive-in fixing
- Recommended maximum 1.5 m spacing
- Easy click function secures pipe in place



Product	Size (mm)	Magestic															Painted	Copper	
		MG	Price (£)	SM	AM	AG	DG	BK	WT	BN	CB	TR	DR	MBK	MAG	MBN			Price (£)
SSVU75	75			⊗Ex	⊗Ex	⊗Ex	⊗Ex	⊗Ex	✓	✓	✓	✓	✓				5.54		
SSVU87	87			⊗Ex	⊗Ex	⊗Ex	⊗Ex	⊗Ex	✓	✓	✓	✓	✓	✓	✓	✓	6.15		
SSVU100	100			⊗Ex	⊗Ex	⊗Ex	⊗Ex	⊗Ex	✓	✓	✓	✓	✓	✓	✓	✓	6.64		
SSVU120	120			✓	✓	✓	✓	✓	✓	✓	✓	✓	✓				7.44		

### SVHA – Screw-to-Wall Pipe Bracket

- Allow screw-to-wall pipe fixing
- Recommended maximum 1.5 m spacing
- Wedge is used to secure pipe in place



Product	Size (mm)	Magestic															Painted	Copper	
		MG	Price (£)	SM	AM	AG	DG	BK	WT	BN	CB	TR	DR	MBK	MAG	MBN			Price (£)
SVHA75	75	⊗Ex	5.43															✓	18.67
SVHA87	87	⊗Ex	5.81															✓	19.40
SVHA100	100	⊗Ex	6.08															✓	21.41
SVHA120	120	✓	6.75															✓	24.72

### SV – Pipe Holder for Spike

- Used with SST spike for drive-in fixing
- Recommended maximum 1.5 m spacing
- Wedge is used to secure pipe in place



Product	Size (mm)	Magestic															Painted	Copper	
		MG	Price (£)	SM	AM	AG	DG	BK	WT	BN	CB	TR	DR	MBK	MAG	MBN			Price (£)
SV75	75	⊗Ex	5.43															✓	18.67
SV87	87	⊗Ex	5.81															✓	19.40
SV100	100	⊗Ex	6.08															✓	21.41
SV120	120	✓	6.61															✓	24.72

Images for illustrative purposes only. Further details of the colour range can be found on page 8



# Pipes & Fittings

## Hoppers

### VATKR – Regular Water Hopper

- Used at the head of a pipe that doesn't directly connect to a gutter
- Rectangular front with square sides, 250 x 150 x 150 mm
- Hoppers may be pressed or fabricated, finish may vary

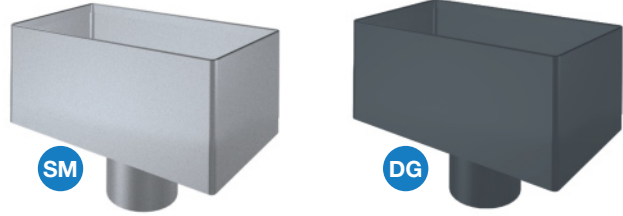

Product	Size (mm)	MG	Price (£)	SM	AM	AG	DG	BK	WT	BN	CB	TR	DR	MBK	MAG	MBN	Price (£)	CU	Price (£)
VATKR75	75	ⓄEx	86.80	ⓄEx	ⓄEx	ⓄEx	ⓄEx	ⓄEx	✓	✓	✓	✓	✓				95.48		
VATKR87	87	ⓄEx	86.80	ⓄEx	ⓄEx	ⓄEx	ⓄEx	ⓄEx	✓	✓	✓	✓	✓	✓	✓	✓	95.48		
VATKR100	100	ⓄEx	86.80	ⓄEx	ⓄEx	ⓄEx	ⓄEx	ⓄEx	✓	✓	✓	✓	✓	✓	✓	✓	95.48		
VATKR120	120	✓	86.80	✓	✓	✓	✓	✓	✓	✓	✓	✓	✓				95.48		

### VATKL – Large Water Hopper

- Used at the head of a pipe that doesn't directly connect to a gutter
- Square top with inverted pyramid sides, 250 x 250 x 250-355 mm
- Hoppers may be pressed or fabricated, finish may vary



Product	Size (mm)	MG	Price (£)	SM	AM	AG	DG	BK	WT	BN	CB	TR	DR	MBK	MAG	MBN	Price (£)	CU	Price (£)
VATKL75	75	ⓄEx	105.02	ⓄEx	ⓄEx	ⓄEx	ⓄEx	ⓄEx	✓	✓	✓	✓	✓				117.98		
VATKL87	87	ⓄEx	105.02	ⓄEx	ⓄEx	ⓄEx	ⓄEx	ⓄEx	✓	✓	✓	✓	✓				117.98		
VATKL100	100	ⓄEx	105.02	ⓄEx	ⓄEx	ⓄEx	ⓄEx	ⓄEx	✓	✓	✓	✓	✓				117.98		
VATKL120	120	✓	105.02	✓	✓	✓	✓	✓	✓	✓	✓	✓	✓				117.98		

### VATKS – Half Round Water Hopper

- Used at the head of a pipe that doesn't directly connect to a gutter
- Cone shape with flat back, 300 x 200 x 300-320 mm
- Hoppers may be pressed or fabricated, finish may vary



Product	Size (mm)	MG	Price (£)	SM	AM	AG	DG	BK	WT	BN	CB	TR	DR	MBK	MAG	MBN	Price (£)	CU	Price (£)
VATKS75	75	✓	120.77	✓	✓	✓	✓	✓	✓	✓	✓	✓	✓				135.68		
VATKS87	87	✓	120.77	✓	✓	✓	✓	✓	✓	✓	✓	✓	✓				135.68		
VATKS100	100	✓	120.77	✓	✓	✓	✓	✓	✓	✓	✓	✓	✓				135.68		

Add the colour reference to the end of the product code at point of order. e.g. R3100BK for 3 m 100 mm HR Gutter in Black finish.

MG = Magestic Galvanised SM = Silver Metallic AM = Anthracite Metallic AG = Anthracite Grey DG = Dark Grey  
 BK = Black WT = Antique White BN = Brown CB = Coffee Brown TR = Tile Red DR = Dark Red  
 MBK = Matte Black MAG = Matte Anthracite Grey MBN = Matte Brown CU = Natural Copper

## Bends

### BK – Conical Pipe Bend

- Conical design provides clean line while allowing male/female connection
- Available in 45, 70 and 85° variations
- Top fits outlets or male spigot ends of pipes, bottom fits into pipes



Product	Angle	Size (mm)	MG	Price (£)	SM	AM	AG	DG	BK	WT	BN	CB	TR	DR	MBK	MAG	MBN	Price (£)	CU	Price (£)
BK7075	70°	75	⊙Ex	16.15	⊙Ex	⊙Ex	⊙Ex	⊙Ex	⊙Ex	✓	✓	✓	✓	✓				17.83	✓	43.20
BK7087	70°	87	⊙Ex	16.82	⊙Ex	⊙Ex	⊙Ex	⊙Ex	⊙Ex	✓	✓	✓	✓	✓	✓	✓	✓	18.43	✓	50.11
BK70100	70°	100	⊙Ex	18.70	⊙Ex	⊙Ex	⊙Ex	⊙Ex	⊙Ex	✓	✓	✓	✓	✓	✓	✓	✓	20.15	✓	53.42
BK70120	70°	120	✓	26.48	✓	✓	✓	✓	✓	✓	✓	✓	✓	✓				27.26	✓	62.52
BK4575	45°	75			⊙Ex	⊙Ex	⊙Ex	⊙Ex	⊙Ex	✓	✓	✓	✓	✓				34.75		
BK4587	45°	87			⊙Ex	⊙Ex	⊙Ex	⊙Ex	⊙Ex	✓	✓	✓	✓	✓	✓	✓	✓	36.24		
BK45100	45°	100			✓	✓	✓	✓	✓	✓	✓	✓	✓	✓	✓	✓	✓	37.74		
BK8575	85°	75			⊙Ex	⊙Ex	⊙Ex	⊙Ex	⊙Ex	✓	✓	✓	✓	✓				26.85		
BK8587	85°	87			⊙Ex	⊙Ex	⊙Ex	⊙Ex	⊙Ex	✓	✓	✓	✓	✓	✓	✓	✓	27.80		
BK85100	85°	100			✓	✓	✓	✓	✓	✓	✓	✓	✓	✓	✓	✓	✓	30.25		

### BKM/BM – Pipe Bend with Socket

- Traditional socket design allows male/female connection
- Available in 45, 70 and 85° variations
- Top fits cut end of standard pipes, bottom fits directly into pipes
- 70° BM bends will be phased out and replaced with new BKM bends with more streamlined design

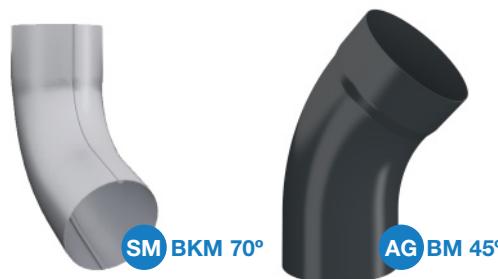

Product	Angle	Size (mm)	MG	Price (£)	SM	AM	AG	DG	BK	WT	BN	CB	TR	DR	MBK	MAG	MBN	Price (£)	CU	Price (£)
BKM7075	70°	75	⊙Ex	16.15	⊙Ex	⊙Ex	⊙Ex	⊙Ex	⊙Ex	✓	✓	✓	✓	✓				17.83	✓	43.20
BKM7087	70°	87	⊙Ex	16.82	⊙Ex	⊙Ex	⊙Ex	⊙Ex	⊙Ex	✓	✓	✓	✓	✓	✓	✓	✓	18.43	✓	50.11
BKM70100	70°	100	⊙Ex	18.70	⊙Ex	⊙Ex	⊙Ex	⊙Ex	⊙Ex	✓	✓	✓	✓	✓	✓	✓	✓	20.15	✓	53.42
BKM70120	70°	120	✓	26.48	✓	✓	✓	✓	✓	✓	✓	✓	✓	✓				27.26	✓	62.52
BM4575	45°	75			⊙Ex	⊙Ex	⊙Ex	⊙Ex	⊙Ex	✓	✓	✓	✓	✓				34.75		
BM4587	45°	87			⊙Ex	⊙Ex	⊙Ex	⊙Ex	⊙Ex	✓	✓	✓	✓	✓	✓	✓	✓	36.24		
BM45100	45°	100			✓	✓	✓	✓	✓	✓	✓	✓	✓	✓	✓	✓	✓	37.74		
BM8575	85°	75			⊙Ex	⊙Ex	⊙Ex	⊙Ex	⊙Ex	✓	✓	✓	✓	✓				26.85		
BM8587	85°	87			⊙Ex	⊙Ex	⊙Ex	⊙Ex	⊙Ex	✓	✓	✓	✓	✓	✓	✓	✓	27.80		
BM85100	85°	100			✓	✓	✓	✓	✓	✓	✓	✓	✓	✓	✓	✓	✓	30.25		

Images for illustrative purposes only. Further details of the colour range can be found on page 8



# Pipes & Fittings

## SOKN – One-Piece Offset Bend

- Used to offset a pipe stack usually to join a gutter outlet or to traverse a plinth
- Set 100 mm projection
- Longer offsets can be assembled using bends and cut down pipes

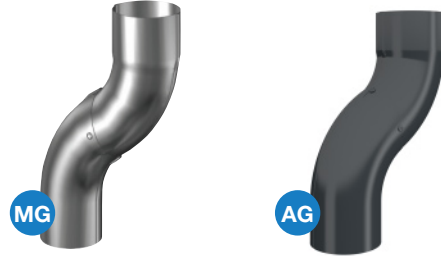

Product	Size (mm)	MG	Price (£)	SM	AM	AG	DG	BK	WT	BN	CB	TR	DR	MBK	MAG	MBN	Price (£)	CU	Price (£)
SOKN75	75	ⓄEx	50.88	ⓄEx	ⓄEx	ⓄEx	ⓄEx	ⓄEx	✓	✓	✓	✓	✓				55.59		
SOKN87	87	ⓄEx	51.57	ⓄEx	ⓄEx	ⓄEx	ⓄEx	ⓄEx	✓	✓	✓	✓	✓	✓	✓	✓	59.16		
SOKN100	100	ⓄEx	62.50	ⓄEx	ⓄEx	ⓄEx	ⓄEx	ⓄEx	✓	✓	✓	✓	✓	✓	✓	✓	64.39		

## Shoes

### UTK – Pipe Shoe

- Angled pipe shoe used to discharge water into a drain or grate
- Socket fits directly to pipe
- Rolled rim ensures no sharp edges



Product	Size (mm)	MG	Price (£)	SM	AM	AG	DG	BK	WT	BN	CB	TR	DR	MBK	MAG	MBN	Price (£)	CU	Price (£)
UTK75	75	ⓄEx	18.16	ⓄEx	ⓄEx	ⓄEx	ⓄEx	ⓄEx	✓	✓	✓	✓	✓				20.44	✓	51.85
UTK87	87	ⓄEx	18.86	ⓄEx	ⓄEx	ⓄEx	ⓄEx	ⓄEx	✓	✓	✓	✓	✓	✓	✓	✓	21.07	✓	60.65
UTK100	100	ⓄEx	21.68	ⓄEx	ⓄEx	ⓄEx	ⓄEx	ⓄEx	✓	✓	✓	✓	✓	✓	✓	✓	24.09	✓	69.20
UTK120	120	✓	39.01	✓	✓	✓	✓	✓	✓	✓	✓	✓	✓				41.07	✓	97.46

### BUTK – Drain Shoe

- Used to connect a pipe directly to a ground drain pipe
- Designed larger than the downpipe so that it can be lifted easily to provide maintenance access
- Fitted with drain cover to sit over the drain pipe



Product	Size (mm)	MG	Price (£)	SM	AM	AG	DG	BK	WT	BN	CB	TR	DR	MBK	MAG	MBN	Price (£)	CU	Price (£)
BUTK75	75	ⓄEx	19.99	ⓄEx	ⓄEx	ⓄEx	ⓄEx	ⓄEx	✓	✓		✓	✓				22.51	✓	115.64
BUTK87	87	ⓄEx	20.76	ⓄEx	ⓄEx	ⓄEx	ⓄEx	ⓄEx	✓	✓	✓	✓	✓	✓	✓	✓	23.18	✓	139.04
BUTK100	100	ⓄEx	23.83	✓	✓	✓	✓	ⓄEx	✓	✓	✓	✓	✓	✓	✓	✓	26.48	✓	166.40
BUTK120	120	✓	42.93	✓	✓	✓	✓	✓	✓	✓			✓				45.18		

Add the colour reference to the end of the product code at point of order. e.g. R3100BK for 3 m 100 mm HR Gutter in Black finish.

MG = Magestic Galvanised SM = Silver Metallic AM = Anthracite Metallic AG = Anthracite Grey DG = Dark Grey  
 BK = Black WT = Antique White BN = Brown CB = Coffee Brown TR = Tile Red DR = Dark Red  
 MBK = Matte Black MAG = Matte Anthracite Grey MBN = Matte Brown CU = Natural Copper

### RT – Drain Trap (HD Polythene)

- Used to prevent leaves and other potential blockages entering the drain
- Connects to 100 mm drain pipe
- Best used with PRT sliding pipe to allow easy cleaning



Product	Size (mm)	MG	Price (£)	SM	AM	AG	DG	BK	WT	BN	CB	TR	DR	MBK	MAG	MBN	Price (£)	CU	Price (£)
RT	100			ⓄEx	ⓄEx	ⓄEx	ⓄEx	ⓄEx	✓	✓	✓	✓	✓				19.00		

### SLS – Self Cleaning Leaf Trap (HD Polythene)

- Used to filter leaves and other potential blockages from entering the drain
- Angled design allows rainwater to clean the filter
- Connects to 100 mm drain pipe, can be used with BUTK Drain Shoe to fit 75 mm or 87 mm pipes



Product	Size (mm)	MG	Price (£)	SM	AM	AG	DG	BK	WT	BN	CB	TR	DR	MBK	MAG	MBN	Price (£)	CU	Price (£)
SLS100	100			ⓄEx	ⓄEx	ⓄEx	ⓄEx	ⓄEx	ⓄEx	✓	✓	✓	✓				32.04		

## Connectors

### GROR – Pipe Branch

- Used to merge a second pipe run into a pipe stack
- Designed to allow pipe to be positioned between 50 and 80°
- Standard branch will connect equal pipe diameters

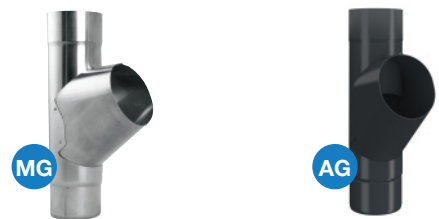

Product	Size (mm)	MG	Price (£)	SM	AM	AG	DG	BK	WT	BN	CB	TR	DR	MBK	MAG	MBN	Price (£)	CU	Price (£)
GROR75	75	ⓄEx	64.02	ⓄEx	ⓄEx	ⓄEx	ⓄEx	ⓄEx	ⓄEx	✓	✓	✓	✓				67.64	✓	129.66
GROR87	87	ⓄEx	69.74	ⓄEx	ⓄEx	ⓄEx	ⓄEx	ⓄEx	✓	✓	✓	✓	✓	✓	✓	✓	79.61	✓	142.19
GROR100	100	ⓄEx	77.35	ⓄEx	ⓄEx	ⓄEx	ⓄEx	ⓄEx	✓	✓	✓	✓	✓	✓	✓	✓	82.94	✓	158.70
GROR120	120	✓	86.47																

Images for illustrative purposes only. Further details of the colour range can be found on page 8



# Pipes & Fittings

## SRORM – Pipe Connector

- Used to connect two pipes if the male spigot has been removed
- Allows pipe offcuts to be used
- Provides male/female connection

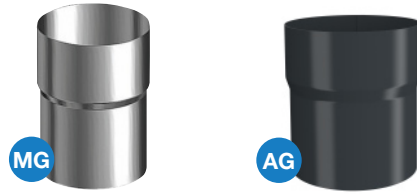

Product	Size (mm)	MG	Price (£)														Price (£)	CU	Price (£)		
				SM	AM	AG	DG	BK	WT	BN	CB	TR	DR	MBK	MAG	MBN					
SRORM75	75	ⓄEx	9.33	ⓄEx	ⓄEx	ⓄEx	ⓄEx	ⓄEx	✓	✓	✓	✓	✓						9.40		
SRORM87	87	ⓄEx	9.53	ⓄEx	ⓄEx	ⓄEx	ⓄEx	ⓄEx	✓	✓	✓	✓	✓	✓	✓	✓	✓		9.67		
SRORM100	100	ⓄEx	12.85	ⓄEx	ⓄEx	ⓄEx	ⓄEx	ⓄEx	✓	✓	✓	✓	✓	✓	✓	✓	✓		13.85		
SRORM120	120	✓	15.46	✓	✓	✓	✓	✓	✓	✓	✓	✓	✓	✓	✓	✓	✓		17.80		

## MRT – Drain Connector (HD Polythene)

- Used to directly connect to a ground drain pipe
- Stepped design fits to multiple sizes
- Fits up to 100 mm down pipes and drain pipes



Product	MG	Price (£)														Price (£)	CU	Price (£)			
			SM	AM	AG	DG	BK	WT	BN	CB	TR	DR	MBK	MAG	MBN						
MRT			ⓄEx	ⓄEx	ⓄEx	ⓄEx	ⓄEx	✓	✓	✓	✓	✓	✓						5.37		

## SLAS – Hose Connector

- Connects pipe directly to a hose
- Fits to 80 mm hose
- Can be attached to the bottom of a pipe stack



Product	Size (mm)	MG	Price (£)														Price (£)	CU	Price (£)		
				SM	AM	AG	DG	BK	WT	BN	CB	TR	DR	MBK	MAG	MBN					
SLAS87	87			✓	✓		✓	✓	✓	✓	✓	✓	✓	✓					23.12		

Visit our website for the latest product updates:  
[www.lindabprofile.co.uk](http://www.lindabprofile.co.uk)

Add the colour reference to the end of the product code at point of order. e.g. R3100BK for 3 m 100 mm HR Gutter in Black finish.  
**MG** = Magestic Galvanised **SM** = Silver Metallic **AM** = Anthracite Metallic **AG** = Anthracite Grey **DG** = Dark Grey  
**BK** = Black **WT** = Antique White **BN** = Brown **CB** = Coffee Brown **TR** = Tile Red **DR** = Dark Red  
**MBK** = Matte Black **MAG** = Matte Anthracite Grey **MBN** = Matte Brown **CU** = Natural Copper

## Diverter

### FUTK – Adjustable Diverter

- Enabled water collection in a water butt or collection system
- Outlet spot manually opens and closes
- Fits directly in pipe stack

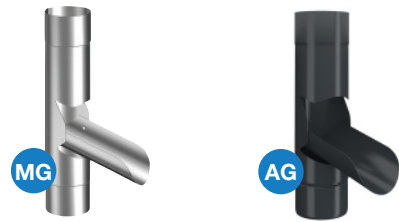

Product	Size (mm)	MG	Price (£)	SM	AM	AG	DG	BK	WT	BN	CB	TR	DR	MBK	MAG	MBN	Price (£)	CU	Price (£)
FUTK75	75	ⓄEx	56.43	ⓄEx	ⓄEx	ⓄEx	ⓄEx	ⓄEx	✓	✓	✓	✓	✓				62.47		
FUTK87	87	ⓄEx	58.16	✓	✓	✓	✓	✓	✓	✓	✓	✓	✓	✓	✓	✓	65.76		
FUTK100	100	✓	63.48	✓	✓	✓	✓	✓	✓	✓	✓	✓	✓	✓	✓	✓	73.49		

### RWDK – Rainwater Diverter Kit

- Plastic components which can be fitted into a pipe stack to divert water
- Flexible hose to discharge into water butt or collection system
- Fits to 75 mm or 87 mm pipes



Product	Size (mm)	Black		White	
		BK	Price (£)	WT	Price (£)
RWDK	75/87	ⓄEx	60.79	✓	60.79

## Lindab Information Gateway

The Information Gateway is a web portal to simplify specification of Lindab building products by providing access to a suite of software and tools for CAD and BIM design.

We recognise the increasing demands on building designers and for some time we have been developing the portal to be easier to use and much more mobile-friendly to support the demands of a modern working environment.



Visit [informationgateway.lindab.com](http://informationgateway.lindab.com) now to begin accessing the improved portal.



Images for illustrative purposes only. Further details of the colour range can be found on page 8



# Vandal Reinforced Pipes

## Downpipes

### VSLs – Reinforced Leaf Trap

- Vandal reinforced 2 mm hot-dipped galvanised steel or 1.5 mm stainless steel plate
- Fits to ground drain pipe
- Used to prevent leaves entering the drain, angled design allows rainwater to clean the filter



Product	Length (m)	Size (mm)	SS	Price (£)	SM	AM	AG	DG	BK	WT	BN	CB	TR	DR	MBK	MAG	MBN	Price (£)
VSL102	300	102	✓	411.18	✓	✓	✓	✓	✓	✓	✓	✓	✓	✓				287.58

### VSLs – Reinforced Pipe with Leaf Trap

- Vandal reinforced 2 mm hot-dipped galvanised steel or 1.5 mm stainless steel plate
- Integrated leaf trap and stainless steel brackets
- Fits to ground drain pipe

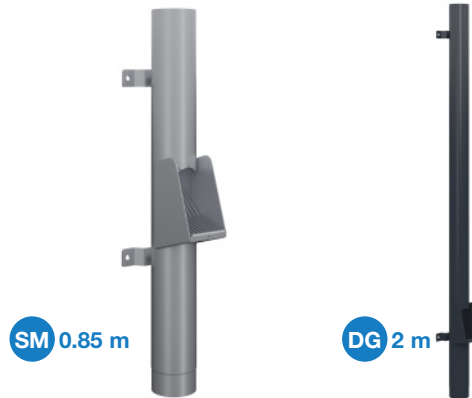

Product	Length (m)	Size (mm)	SS	Price (£)	SM	AM	AG	DG	BK	WT	BN	CB	TR	DR	MBK	MAG	MBN	Price (£)
VSL09102	0.85	102	✓	595.59	✓	✓	✓	✓	✓	✓	✓	✓	✓	✓				430.35
VSL2102	2	102	✓	791.37	✓	✓	✓	✓	✓	✓	✓	✓	✓	✓				526.21

Add the colour reference to the end of the product code at point of order. e.g. R3100BK for 3 m 100 mm HR Gutter in Black finish.

**MG** = Magestic Galvanised **SM** = Silver Metallic **AM** = Anthracite Metallic **AG** = Anthracite Grey **DG** = Dark Grey

**BK** = Black **WT** = Antique White **BN** = Brown **CB** = Coffee Brown **TR** = Tile Red **DR** = Dark Red

**MBK** = Matte Black **MAG** = Matte Anthracite Grey **MBN** = Matte Brown **CU** = Natural Copper



### VSLST – Reinforced Pipe with Raised Leaf Trap

- Vandal reinforced 2 mm hot-dipped galvanised steel or 1.5 mm stainless steel plate
- Integrated stainless steel brackets and raised leaf trap out of reach of children
- Fits to ground drain pipe

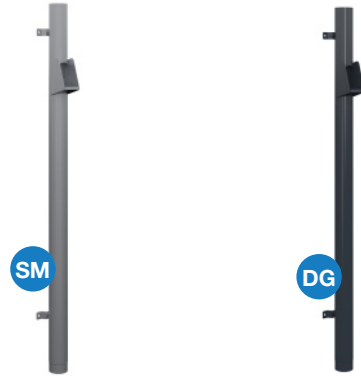

Product	Length (m)	Size (mm)	SS	Price (£)	SM	AM	AG	DG	BK	WT	BN	CB	TR	DR	MBK	MAG	MBN	Price (£)
VSLST2102	2	102	✓	791.37	✓	✓	✓	✓	✓	✓	✓	✓	✓	✓	✓	✓	✓	526.21

### VUTK – Vandal Reinforced Pipe with Shoe

- Vandal reinforced 2 mm hot-dipped galvanised steel or 1.5 mm stainless steel plate
- Integrated shoe and stainless steel brackets
- To discharge water over a drain or grate



Product	Length (m)	Size (mm)	SS	Price (£)	SM	AM	AG	DG	BK	WT	BN	CB	TR	DR	MBK	MAG	MBN	Price (£)
VUTK09102	0.85	102	✓	493.58	✓	✓	✓	✓	✓	✓	✓	✓	✓	✓	✓	✓	✓	477.26
VUTK2102	2	102	✓	681.23	✓	✓	✓	✓	✓	✓	✓	✓	✓	✓	✓	✓	✓	571.07

Images for illustrative purposes only. Further details of the colour range can be found on page 8



# Accessories

## STIFT/BF – Touch Up Paint

- Use during installation or maintenance
- Drill holes, cut edges or scratches should be touched up
- Supplied in 12 ml bottle with applicator brush or 250 ml tin



STIFT



BF



Product	Size (ml)	SM	AM	AG	DG	BK	WT	BN	CB	TR	DR	MBK	MAG	MBN	Price (£)
STIFT12	12	ⓄEx	ⓄEx	ⓄEx	ⓄEx	✓	✓	✓	✓	✓	✓				23.47
BF250	250	ⓄEx	ⓄEx		ⓄEx	ⓄEx	✓	✓	✓	✓	✓				58.05

## LGB – Leafline Gutter Brush

- Stainless steel wire core with polypropylene bristles, sits in gutter to catch leaves
- Supplied in 3 m lengths
- No fastenings are required

Product	Length (m)	Size (mm)	Black		Opaque	
			BK	Price (£)	OQ	Price (£)
LGB100	3	100	ⓄEx	23.06	ⓄEx	23.06
LGB125	3	125	ⓄEx	27.06	ⓄEx	27.06
LGB150	3	150	ⓄEx	30.10	ⓄEx	30.10



## DVSIL – Leaf Filter

- Used to filter leaves and other potential blockages from the drain pipe
- Sits inside drain pipe, suspended by hooks
- Stainless steel, usually used with BUTK Drain Shoe to simplify cleaning

Product	Size (mm)	Price (£)
DVSIL	100	ⓄEx 47.69



Add the colour reference to the end of the product code at point of order. e.g. R3100BK for 3 m 100 mm HR Gutter in Black finish.

MG = Magestic Galvanised SM = Silver Metallic AM = Anthracite Metallic AG = Anthracite Grey DG = Dark Grey

BK = Black WT = Antique White BN = Brown CB = Coffee Brown TR = Tile Red DR = Dark Red

MBK = Matte Black MAG = Matte Anthracite Grey MBN = Matte Brown CU = Natural Copper

### SST – Spike (for Pipe Holder)

- Used with pipe holder to fix pipe to the wall
- Spike is ordered separately, supplied unpainted, may be painted with touch up paint once installed
- When the pipe holder is closed the spike locks into place



Product	Length (m)		Price (£)
SST125	125	ⓄEx	4.95
SST175	175	ⓄEx	5.89
SST250	250	ⓄEx	7.50
SST300	300	ⓄEx	8.35

### SSC – Fastener Set with Spacer

- Fixing screw for SSVU to wood, concrete or light concrete
- Screw supplied with plastic wall plug and spacers

Product	Distance from wall (mm)		Price (£)
SSC25	25	ⓄEx	14.26
SSC55	55	ⓄEx	18.33
SSC85	85	ⓄEx	22.22
SSC115	115	ⓄEx	25.65



### FS – Fixing Screws

- Supplied in pack of 200
- 4.8 mm pozi head 25 mm threaded screws

Product	Quantity	Size (mm)		Price (£)
FS25	200	25x4.8	ⓄEx	10.81



### KBO – Bracket Bender

- Used to bend rafter brackets to the required angle
- Brackets can be supplied bent or twisted to suit for an additional charge of £2 per bracket

Product		Price (£)
KBO	ⓄEx	174.16

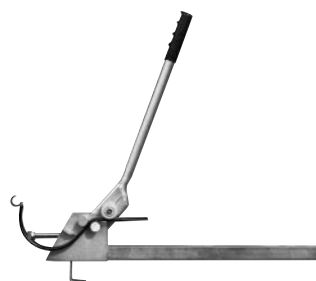

### VP300- Elite 300 Underlay

- Medium weight vapour permeable roofing underlay
- Supplied in 1.5 m x 50 m roll

Product	Size (m)		Price (£)
VP300	1.5 x 50	ⓄEx	126.48

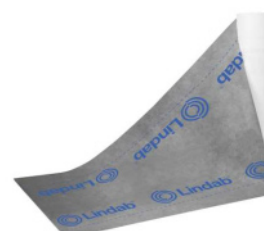

Images for illustrative purposes only. Further details of the colour range can be found on page 8



# Simplifying the science – size guide

It is important that the sizes of gutters and pipes used in a rainwater system are selected with consideration of the size of the roof and the position of downpipes in order to ensure that typical rainfall does not cause the system to overflow.

All gutter systems in the UK should be designed to BS EN 12056-3:2000 Gravity drainage systems inside buildings. Roof drainage, layout and calculation (AMD 17041), 2000.

Rainline gutters are available in two shapes and five sizes. Half Round: 100mm, 125mm, 150mm, 190mm and Rectangular 140mm. Downpipes are available in four sizes: 75mm, 87mm, 100mm and 120mm.

## Half round gutters (R)

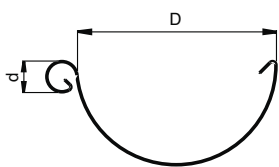

Size (mm)	D (mm)	d (mm)
100	107	17
125	123	17
150	155	17
190	192	22

## Rectangular gutters (RTRA)

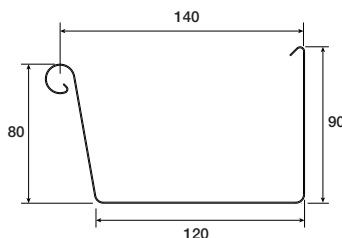

## Downpipes (SROR)

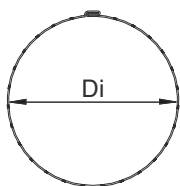

Size (mm)	Di (mm)
75	75
87	87
100	100
120	120

## Roof area

BS EN 12056-3:2000 requires that wind driven rain is taken into account when considering the effective catchment area. The standard assumes that rain falls at an angle of 2 units vertical to 1 unit horizontal which means that half the vertical height of any surface must be taken into account in calculations.

For a typical roof surface this means that the effective area is calculated from:

$$\text{Effective area, AE (m}^2\text{)} = L \times (W + H/2)$$

Where:

L= Roof length (m)

W= Eaves to ridge width (m)

H= Eaves to ridge height (m)

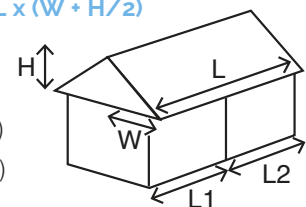

## Flow capacities

In order to select the appropriate gutter and pipe size combination it is necessary to understand the flow rate required and the flow capacity of the system. The presence of corners in the gutter reduces the capacity, where this is applicable a 15% reduction should be assumed for calculations.

**Flow rate is calculated from:**

**Flow rate (litres/second)**

**= Effective area x rainfall intensity**

## Pipe position

The position of the pipe has a significant effect on the flow capacity of a rainwater system.

A gutter ratio can be used in conjunction with the effective roof area to account for the required adjustment in system flow rate.

For a typical gutter run up to a maximum of 10m the ratio of gutter lengths is calculated from:

$$\text{Gutter Ratio} = L1 / (L1 + L2)$$

Where:  $L1 \geq L2$

## Selecting gutter size

There is no standard rate of rainfall in the UK so for accurate calculations refer to an approved weather authority to get a site-specific rainfall level. Our technical department can assist with calculations for your project locations.

The charts below allow effective area and gutter ratio to be used to choose the correct gutter and pipe size. A 1 year storm calculation is measured at up to 0.022 litres per second per square metre and up to 0.036 litres per second per square metre for a 5 year storm calculation as recommended by British Standards. For gutter runs longer than 10m contact us for further advice.

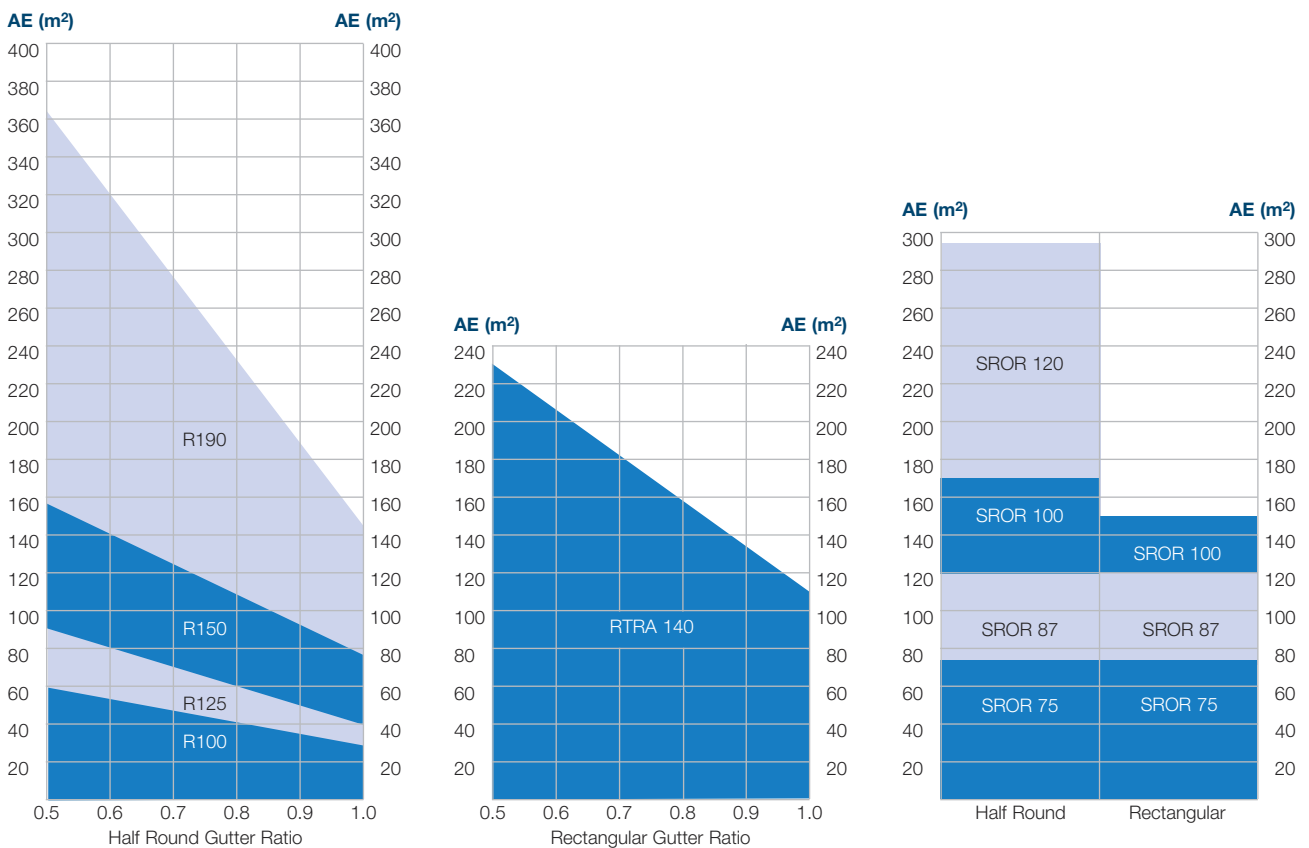



# Understanding brackets

Roof construction type, stage of build and preferred method of installation can influence the type of bracket chosen for a project. The main bracket types are fascia brackets and rafter brackets.

## Fascia bracket

Fascia brackets fix to a fascia board or directly to the wall of a building. Vertical fascia boards are most common in the UK however adjustable fascia brackets are available for use on angled fascia boards.

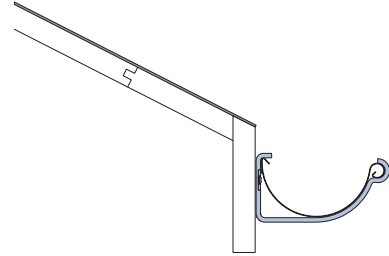

## Rafter bracket

Rafter brackets are fixed directly to the roof rafters, typically on buildings with overhanging roof structures or with particularly uneven wall surfaces. Rafter bars can be twisted to enable side fixing where access to the top of the rafter is limited.

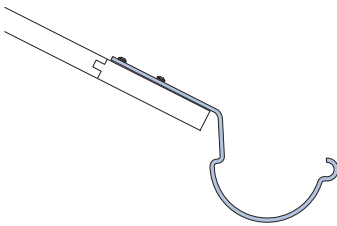

Rafter bars should be bent to the required angle based on the pitch of the roof, a KBO bracket bender can be used. Rafters can be twisted or bent for a charge of £2 per bracket.

## Number of brackets

Brackets should be installed at 600mm centres. End brackets should be installed 100mm from roof edge.

To calculate how many brackets are required use the following formula:

**No. of brackets =  $(L \div 0.6) + 1$**  Where: L = length of run in metres

## Bracket installation

Gutters should be installed so that the gutter falls towards the outlet dropping by 10mm over every 3m length, (a fall of 1:300). A single run should not exceed 10m.

In order to achieve the required slope install the lowest bracket first (next to the outlet) and then the highest bracket (at the opposite end of the gutter run). Pull a string between the two brackets, the string indicates the level that the other brackets should be fixed.

Where multiple downpipes are positioned along one gutter run the gutter should be installed with a high point between the pipes and sloping towards each outlet.

The front lip of the highest bracket should not be installed higher than the position horizontally in line with the roof edge. In areas with heavy snowfall the highest bracket should be installed lower. Rectangular gutter installation follows the same principles as half round gutter installation.

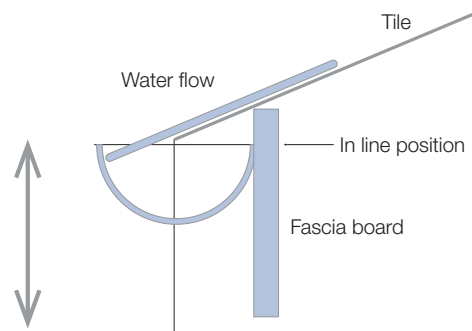
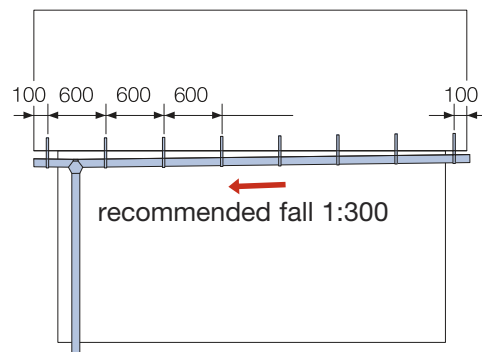

## Creating offsets

The roofline of a building, where the gutter is fitted, is commonly positioned away from the walls of the building. An offset arrangement is used to connect the outlet to a downpipe stack.

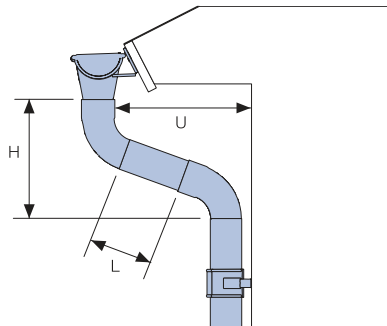

The measurement U is the projection of the offset. An SOKN one-piece offset is available with a fixed projection of 100mm.

For larger projections an offset can be created using pipe bends and a length of SROR pipe or an MST intermediate pipe cut down to the required length.

The table can be used to indicate the length of the pipe required to make the offset.

Bends at an angle of 70° are typically used to create offsets, 85°/90° bends may be preferred for very long projections however flow capacity will be reduced.

A BK conical bend should be used at the top of the offset. If the pipe used has a spigot bottom a BK conical bend should also be used at the bottom of the offset. If the pipe used does not have a spigot bottom a BM or BKM pipe bend with socket should be used at the bottom.

Intermediate pipe length at 70° bends

U mm	H mm	L mm
220	275	0
270	290	100
300	300	135
350	320	185
400	340	240
450	355	290
500	375	345
550	395	400
600	410	455
650	430	505
700	450	580
750	465	610
800	485	665
850	505	720
900	520	770
950	540	825
1000	555	880
1050	575	930
1100	595	985
1150	610	1040
1200	630	1090

### Pipe bracket installation

Pipe brackets should be installed at 1.5m centres. The highest pipe bracket should be installed 150mm from the offset or hopper head at the top of the pipe stack. A spirit level or plummet line can be used to align the other brackets.

Pipe brackets are typically installed using screw-to-wall fixing or drive-in fixing. Choice can be influenced by the construction type of the building, installer preferences or regional conventions.

Rainline SSVU universal pipe brackets can be installed using either fixing method and have a neat click lock mechanism. Unpainted Rainline systems use SVHA brackets for screw-to-wall fixing and SV brackets for drive-in fixing and have an easy to use wedge lock mechanism. Drive in spikes should be ordered separately.

Screw-to-wall fixing

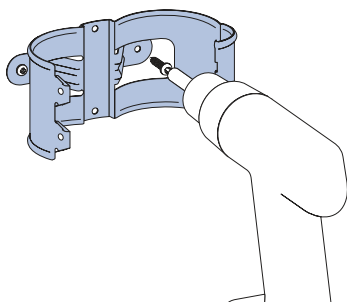

Drive-in fixing

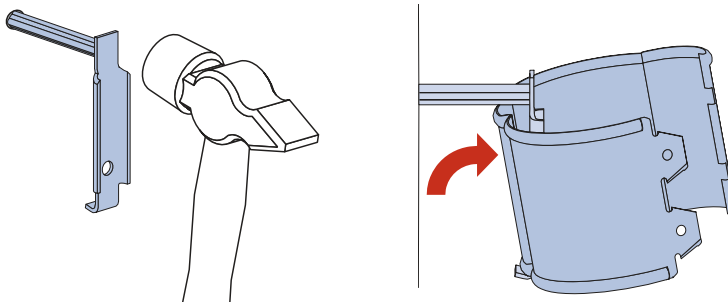



# Steel you can trust

Your customers place their home and property in your hands. They believe in your craftsmanship and expertise. They put their trust in you. This means that you, quite rightly, demand high standards from the products you use. We have created building components from light gauge metal for over 60 years. When you choose Lindab steel roofing you also secure a partner that will understand you and your business.

Whether you require coils for a standing seam roof or pre-formed click seam roof profiles and flashings, we have a comprehensive range of colours and finishes of high quality material that has been designed to be easy to work with. With our design and specification support and reliable distribution you'll be able to safeguard your customers' peace of mind and provide a result that delivers on your promise.





# We simplify design

Imagine if we could help you shorten your design and installation phase, minimise the risks and create better design solutions. We know your time is costly. So to help you develop optimal, reliable solutions in the shortest possible time, we want to give you what you need: a large range of intelligent and rational software that makes your work easier, for example within calculation, specifying and CAD/BIM. Our software packages are the most complete packages available on the market within lightweight construction.



## Information Gateway

To simplify specification of Lindab building products, Information Gateway provides access to a suite of software and tools for CAD and BIM design. Lindab recognise the increasing demands on building designers and have developed the portal to be easy to use and mobile-friendly to support the demands of a modern working environment.

In addition to CAD add-ons, Revit extensions, Eurocode based design software and calculators, the recently updated version of Information Gateway also supports multiple languages and allows you to keep up to date with news and releases.

## BIM objects

Lindab has many product categories available as BIM objects, and they are under constant development. Today you can find BIM objects for roof drainage, roof profiles, roof safety and standing seam roofing.



For more information, go to [informationgateway.lindab.com](http://informationgateway.lindab.com)

## RIBA Approved CPD Scheme

Continuous Professional Development enables architects to achieve better outcomes and better businesses. CPD also helps you to face current and future challenges as well as learn new skills and specialisms.

Lindab are proud providers of a RIBA approved CPD programme examining options for rainwater drainage.



**Steel Rainwater Systems:**  
the Contemporary and Sustainable Solution

To book a CPD seminar, email [cpd@lindab.co.uk](mailto:cpd@lindab.co.uk)



# Simplifying specification

NBSPlus

A general guidance framework for a specification for Lindab rainwater systems is provided below, content should be selected as appropriate to the project.

For a size specific NBS specification visit [www.ribaproductselector.com/lindab](http://www.ribaproductselector.com/lindab), for further project specification advice contact [profile@lindab.co.uk](mailto:profile@lindab.co.uk)

## R10 Rainwater drainage systems

GENERAL	
<ul style="list-style-type: none"> <li>• Gravity rainwater drainage system</li> <li>• Design to BS EN 12056-3:2000 Gravity drainage systems inside buildings. Roof drainage, layout and calculation (AMD 17041), 2000.</li> <li>• Gutters, pipes and fittings to BS EN 612:2005: Eaves gutters with bead stiffened fronts and rainwater pipes with seamed joints made of metal sheet</li> </ul>	
MANUFACTURER	
Lindab Ltd Tel: 0121 585 2780 Fax: 0121 585 2782 Email: <a href="mailto:profile@lindab.co.uk">profile@lindab.co.uk</a>	
PRODUCT SPECIFICATION (GUTTERS AND FITTINGS)	
332 CONTINUOUSLY HOT DIP COATED STEEL GUTTERS/ 335 GALVANISED STEEL GUTTERS/ 330 COPPER GUTTERS	
<b>Product reference:</b>	Rainline coated steel/ Rainline natural copper/ Magestic galvanised steel gutter system
<b>Profile:</b>	R Half Round/ RTRA Rectangular
<b>Size:</b>	100mm/ 125mm / 150mm/ 190mm/ 140mm
<b>Outlet size:</b>	75mm/ 87mm/ 100mm/ 120mm
<b>Grade:</b>	0.6mm steel/ 0.6mm copper
<b>Finish:</b>	045 Silver Metallic/ 044 Anthracite Metallic/ 015 Black/ 001 Antique White/ 087 Dark Grey/ 434 Brown/ 742 Tile Red/ 758 Dark Red/ 387 Coffee Brown/ 035 Anthracite Grey/ 015M Matte Black/ 035M Matte Anthracite Grey/ 434M Matte Brown/ Unpainted Magestic Galvanised/ Natural Copper
FITTINGS	
<b>Joints:</b>	RSK gutter joint/ RTSK rectangular gutter joint/ roll joint method /As drawing ___ / Contractor's choice
<b>Stop ends:</b>	Not required/ RG Self-locking stop end/ RGV Left hand stop end/ RGH Right hand stop end/ RGU Universal stop end/ RTGV Left hand rectangular stop end/ RTGH Right hand rectangular stop end/ As drawing ___ / Contractor's choice
<b>Angles:</b>	Not required/ RVI Internal 90° gutter angle/ RVI Internal 135° gutter angle/ RVY External 90° gutter angle/ RVY External 135° gutter angle/ RTVI Internal rectangular 90° gutter angle/ RTVI Internal rectangular 135° gutter angle/ RTVY External rectangular 90° gutter angle/ RTVY External rectangular 135° gutter angle/ As drawing___ / Contractor's choice

<b>Outlets:</b>	OMV Gutter outlet/ OK Gutter outlet /RTOK Rectangular Outlet/ As drawing___ / Contractor's choice
<b>Brackets:</b>	KFK Fascia bracket/ K24 240mm Flex-fit fascia bracket/ K07 70mm Flex-fit fascia bracket/ SKK Adjustable fascia bracket/ KFM 150mm Rafter bracket/ KFL 200mm Rafter bracket/ KFL35 350mm Rafter bracket/ K18 180mm Flex-fit rafter bracket/ K21 210mm Flex-fit rafter bracket/ K33 330mm Flex-fit rafter bracket/ KRT Side-fix rafter bracket/ RFKF Rise and fall bracket/ RSKR radius gutter bracket/ RTK07 Rectangular 70mm flex-fit fascia bracket/ RTKFK Rectangular fascia bracket/ RTK21 Rectangular 210mm rafter bracket/ As drawing ___/ Contractor's choice
<b>Overflow protectors:</b>	Not required/ OSKR Straight overflow protector/ OSK Corner overflow protector/ As drawing ___ / Contractor's choice
<b>Stay straps:</b>	Not required/ STAG stay strap/ As drawing ___ / Contractor's choice
<b>Accessories:</b>	Not required/ LGB Leafline gutter brush
<b>PRODUCT SPECIFICATION (PIPES AND FITTINGS)</b>	
395 HOT DIP COATED STEEL PIPEWORK – PRESSED/ 370 GALVANISED STEEL PIPEWORK/ 431 STAINLESS STEEL PIPEWORK/ 390 COPPER PIPEWORK	
<b>Product reference:</b>	Rainline coated steel/ Rainline natural copper/ Magestic galvanised steel gutter system
<b>Profile:</b>	SROR Round/ VANDAL Reinforced Round
<b>Size:</b>	75mm/ 87mm/ 100mm/ 120mm/ 102mm
<b>Grade:</b>	0.6mm steel/ 0.7mm steel (120mm only)/ 2.0mm (102mm only)/ 1.5mm stainless steel (102mm only)/ 0.6mm copper
<b>Finish:</b>	045 Silver Metallic/ 044 Anthracite Metallic/ 015 Black/ 001 Antique White/ 087 Dark Grey/ 434 Brown/ 742 Tile Red/ 758 Dark Red/ 387 Coffee Brown/ 035 Anthracite Grey/ 015M Matte Black/ 035M Matte Anthracite Grey/ 434M Matte Brown/ Unpainted Magestic Galvanised/ Natural Copper/ Stainless Steel
<b>Joints:</b>	Male/ female jointing
<b>FITTINGS</b>	
<b>Bends:</b>	Not required/ BK 70° Conical pipe bend/ BK 45° Conical pipe bend/ BK 85° Conical pipe bend/ BKM 70° Pipe bend with socket/ BM 45° Pipe bend with socket/ BM 85° Pipe bend with socket/ As drawing ___ / Contractor's choice
<b>Offsets:</b>	Not required/ SOKN One-piece offset/ Created using bends and intermediate pipe/ As drawing___ / Contractor's choice
<b>Intermediate pipe:</b>	Not required/ MST Intermediate pipe 1m/ MST Intermediate pipe 0.5m/ As drawing___ / Contractor's choice
<b>Access pipe:</b>	Not required/ MSTR Rod access pipe 1m/ PRT Sliding pipe/ As drawing___ / Contractor's choice
<b>Branches:</b>	Not required/ GROR Pipe branch/ GROR Unequal pipe branch/ As drawing___/ Contractor's choice
<b>Connector:</b>	Not required /SRORM Pipe connector/ SLAS Hose Connector/ MRT Drain connector (HD Polythene)/ As drawing___/ Contractor's choice



<b>Shoes:</b>	Not required/ UTK Pipe shoe/ BUTK Drain shoe/ As drawing ___/ Contractor's choice
<b>Hoppers:</b>	Not required/ VATKR Regular water hopper/ VATKL Large water hopper/ VATKS Half round water hopper/ As drawing___/ Contractor's choice
<b>Diverter:</b>	Not required/ FUTK Adjustable diverter/ RWDK Rainwater diverter kit (HD Polythene)/ As drawing ___ / Contractor's choice
<b>Brackets:</b>	Not required/ SSVU Universal Pipe Bracket/ SVHA Downpipe bracket/ SV Pipe holder (for spike)/ SST Spike (for pipe holder)/ As drawing ___/Contractor's choice
<b>Reinforced pipes:</b>	Not required/ VLSL Reinforced leaf trap/ VLSL09 Reinforced Pipe with leaf trap 0.85m/ VUTK09 Reinforced pipe with show 0.85m/ VLSL2 Reinforced pipe with leaf trap 2m/ VSLST2 Reinforced pipe with raised leaf trap 2m/ VUTK2 Reinforced pipe with show 2m/ As drawing ___ /Contractor's choice
<b>Accessories:</b>	Not required/ DVSIL Leaf filter (stainless steel)/ RT Drain Trap (HD Polythene)/ SLS Self-cleaning leaf trap (HD Polythene)

## Recommendations

### INSTALLATION GENERALLY:

- Install pipework/gutters to ensure the complete discharge of rainwater from the building without leaking.
- Obtain all components for each type of pipework/guttering from the same manufacturer unless specified otherwise.
- Provide access fittings and rodding eyes as necessary in convenient locations to permit adequate cleaning and testing of pipework.
- Avoid contact between dissimilar metals and other materials which would result in electrolytic corrosion.
- Do not bend plastics or galvanized steel pipes. Adequately protect pipework/gutters from damage and distortion during construction.
- Where not specified otherwise use plated, sherardised, galvanised or nonferrous fastenings, suitable for the purpose and background, and compatible with the material being fixed.

### FIXING AND JOINTING:

- Fix gutters securely at maximum 600mm centres and at all joints in gutters, with additional brackets near angles and outlets.
- Ensure that roofing underlay is dressed into gutter.
- Ensure that outlets are securely fixed before connecting pipework. To cut the hole for the outlet a hack saw or metal cutting hole saw should be used. Use a hammer on the edges to create a drip edge.
- Fix pipes securely at maximum 1.5m centres plumb and/or true to line. Fix every length of pipe at or close below the coupling.
- Make changes in direction of pipe runs only where shown on drawings unless otherwise approved.
- Fix branches and low gradient sections with uniform and adequate falls to drain efficiently. Provide additional supports as necessary to support junctions and changes in direction.
- Fix externally socketed pipes/fittings with sockets facing upstream.
- Provide a load bearing support for vertical pipes at not less than every storey level. Tighten fixings as the work proceeds so that every storey is self-supporting and undue weight is not imposed on fixings at the base of the pipe.
- Cut ends of pipes to be clean and square with burrs and swarf removed. Ensure that jointing surfaces are clean immediately before assembly.

### CUTTING:

- Cut the gutters and pipes with plate shears, hacksaw or chop saw on a firm underlay on the ground.
- Never use an angle grinder. It heats the steel up and thus destroys the galvanisation. The coating may also be scorched by hot chips or filings.

**COATED PIPEWORK/GUTTERS:**

- Make sure that the roof drainage components are handled with care during transport, storage and unpacking. If not, the coating may be damaged or the pipes and gutters dented.
- Store pipes and gutters on a plane and stable surface.
- Non coated components must be unpacked and stored in a dry and ventilated place.
- Make good to coatings after cutting and any other damage or recoat.

**ACCESS FOR TESTING AND MAINTENANCE:**

- Install pipework and gutters with adequate clearance to permit testing, cleaning and maintenance.
- Position access fittings and rodding eyes so that they are not obstructed by other pipework, framing, etc.

**TESTING:**

- Inform the Contractor Administrator sufficiently in advance to give him a reasonable opportunity to observe tests.
- Check that all sections of installation are free from obstruction and debris before testing.
- Provide clean water, assistance and apparatus for testing as required.
- Carry out tests as specified. After testing, locate and remedy all defects without delay and retest as instructed.
- Keep a record of all tests and provide a copy of each to the Contractor Administrator.
- To complete a gutter test- block all outlets, fill gutters to overflow level and after 5 minutes closely inspect for leakage.

**MAINTENANCE:**

- Complete maintenance on the system 1-2 times a year.
- Clean the gutter and pipes from leaves and debris. Wash with water and a mild detergent.
- Don't use a high pressure washing appliance.
- At completion, submit printed instructions recommending procedures for maintenance of the rainwater installation including full details of the recommended inspection, cleaning and repair procedures.

**BEFORE HANDOVER:**

- Remove construction rubbish and debris from all roofs and gutters. Where possible, sweep and remove fine dust which may enter rainwater systems. Do not sweep or flush dust or debris into the rainwater system.
- Remove swarf, debris and any temporary caps from the entire rainwater installation.
- Ensure that all access covers etc. are secured complete with all fixings.

**BIM in practice – Lycksele Hospital**

Comprehensive renovation of hospital roof.

The construction sector is becoming more and more digitised, with many market players using Lindab's BIM objects on a daily basis. When Lycksele Hospital was due for a new felt roof with solar panels, a roof safety system and roof water drainage system, Lindab's BIM library was a major help to architectural engineer Jonatan Jacobsson at TM Konsult. Read more on The Lindab Blog: [blog.lindab.com](http://blog.lindab.com)

**Roof Safety System**

**Rainwater System**

**Sheet Steel Cladding**

**BIM objects**

**New BIM objects available. Reinforced pipes.**

**Download now from BIMObject.com**



## We simplify construction

At Lindab, we simplify construction because it is in human nature to build. By simplifying in every stage, we make it easier to build sustainably. We develop products with the environment in mind. We invent complete solutions that meet the demands for comfort, simplicity and energy efficiency.

We do this so that you can continue building with a clear conscience – not just today, but also tomorrow.

### What do we simplify?

With the service, support and availability we provide, our broad product portfolio of smart products and solutions builds an offering that simplifies the construction of energy-efficient buildings.

### Indoor Climate Solutions

An experienced team of engineers provide support with technical specification of waterborne and airborne systems for indoor climate solutions.

**Tel: 01604 788383**

**Email: [ICS@lindab.co.uk](mailto:ICS@lindab.co.uk)**

### Air Duct Systems & Acoustic Solutions

High quality ducting and fittings and a range of acoustic attenuation solutions are available through a network of 22 Lindab branches.

**Find your local branch: [www.lindab.co.uk](http://www.lindab.co.uk)**

**Email: [sales@lindab.co.uk](mailto:sales@lindab.co.uk)**

### Air Movement & Air Handling Units

Specialist support teams can offer expert advice relating to selection and specification of air handling units and fans from industry leading manufacturers.

**Email: [fans@lindab.co.uk](mailto:fans@lindab.co.uk)**

**Email: [ahu@lindab.co.uk](mailto:ahu@lindab.co.uk)**

### Residential Ventilation Solutions

BPEC qualified professionals can provide comprehensive project designs for domestic MEV and MVHR systems and a wide range of residential ventilation solutions.

**Tel: 023 8024 0958**

**Email: [residential@lindab.co.uk](mailto:residential@lindab.co.uk)**

### Profile

Lindab's industry leading steel rainwater system, Rainline and steel roofing solution, Coverline are available through reputable builders merchants. Standing seam roofing contractors should contact our technical department directly for Seamline.

**Find your local distributor: [www.lindabprofile.co.uk](http://www.lindabprofile.co.uk)**

**Email: [profile@lindab.co.uk](mailto:profile@lindab.co.uk)**

**Technical: [profile.technical@lindab.co.uk](mailto:profile.technical@lindab.co.uk)**

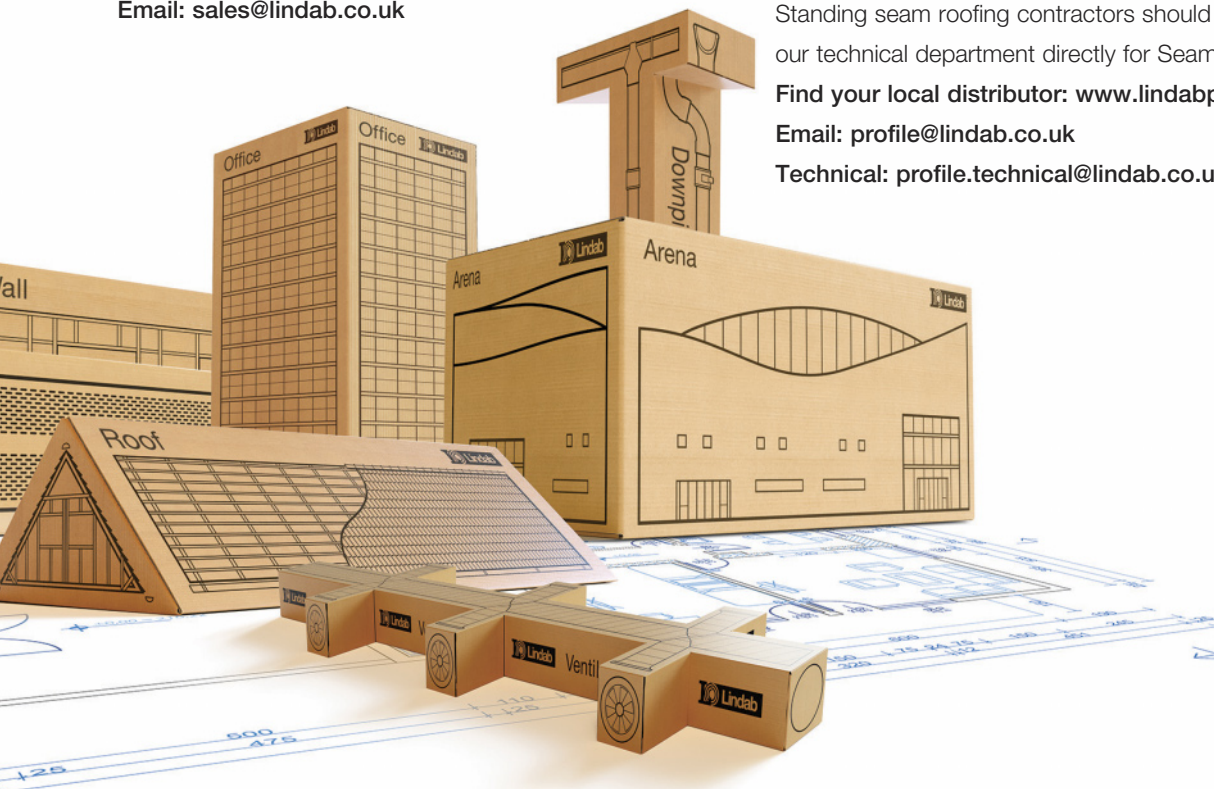



Lindab Roof Hoods

Lindab Wall Profiles

Lindab Solus

Lindab Facade Cassettes

Lindab Residential Ventilation

Lindab Fire & Smoke

Lindab Pascal

Lindab Airy

Lindab Air Movement

Lindab Air Ducts

Lindab Rainline

Lindab Fans

Lindab IT Solutions

## There is always a **solution**

An extensive range of building products, ventilation products and indoor climate systems delivered as standard or customised to suit requirements. Lindab solutions are some of the most simple and energy-efficient available.



Most of us spend the majority of our time indoors. Indoor climate is crucial to how we feel, how productive we are and if we stay healthy.

We at Lindab have therefore made it our most important objective to contribute to an indoor climate that improves people's lives. We do this by developing energy-efficient ventilation solutions and durable building products. We also aim to contribute to a better climate for our planet by working in a way that is sustainable for both people and the environment.

[Lindab](#) | For a better climate

#### Lindab Profile

**Tel:** (0121) 585 2780  
**Fax:** (0121) 585 2782  
**Email:** [profile@lindab.co.uk](mailto:profile@lindab.co.uk)  
**Web:** [lindabprofile.co.uk](http://lindabprofile.co.uk)

© 2022 Lindab Ltd. is a registered trademark of Lindab Ltd, as are the designation of our product ranges. Lindab Ltd reserves the right to make alterations without prior notice.

Whilst every care has been taken in the preparation of this brochure, some changes may have occurred since publication. Lindab Ltd is not responsible for omissions or typographical errors.

