



saunum

Sauna climate unit **Saunum AirSolo**





Sauna climate unit **Saunum AirSolo**

- INSTRUCTIONS FOR INSTALLATION AND USE



saunum

Saunum AirSolo



THE BEST SAUNA EXPERIENCE TO HAVE!

I am very glad that you have invested in the Saunum device, and I believe that our innovative technology will offer you a wonderful and extraordinary sauna experience.



I have a degree in thermal engineering and come from the Southern Estonia, where my love for saunas began. The special feature of local historic smoke saunas is the lower temperature and higher humidity level than, for example, a classic Finnish sauna. In ordinary saunas, the stone volume of the sauna heater is generally small. Such an arrangement can cause a sudden, burning hot steam and an extremely uneven temperature, where your head and shoulder level is really hot, but your feet are left cold. Such an experience can be quite unpleasant and may cause headaches and lead to body stress. However, in ancient smoke saunas and Native American saunas, the stones were first heated during the day. Then the heat stored in the stones was used to cleanse the body and create a truly enjoyable sauna experience.

Inspired by the experience of a smoke sauna, I wanted to create an innovative solution that combines the best features of an authentic sauna with modern technology; enabling a pleasantly mild and relaxing sauna experience without painfully scorching steam. For that, however, I had to solve the problem of how to achieve an even temperature, at both the head and foot levels. My development work was supported by research done alongside Tallinn University of Technology,



in which we analyzed the thermal stratification and air movement in the sauna room. Saunum was born in cooperation between scientific thinking and technological innovation.

Saunum's unique patented mixing system of air layers captures the hot steam that rises under the ceiling of the sauna room, mixes it with the cooler air from the surface of the floor, and directs the milder steam back evenly. This makes for an enjoyable, unaggressive heat. You can sit in the sauna for a longer time, and enjoy a sweat and a deep cleanse without feeling tired. The stone volume of our heaters is significantly larger than other sauna heaters, which is the reason for the especially pleasant indoor climate with long and soft steam.

A moist steamy sauna, a sanarium, a therapeutic salt sauna, or a healthy aroma sauna – all of these functions are available on Saunum's devices to create a truly relaxing sauna experience. When using Himalayan salt balls in our device, salt ions that are beneficial to skin and respiratory tract evaporate and the steam circulates these into the air. Adding a sauna aroma system that blends steam and healthy aroma oil creates an even more enjoyable sauna environment.

Saunum's sauna devices are suitable for both adults and children.

Have a pleasant sauna!

Andrus Vare
The creator of Saunum



Saunum Saunas
congratulates you
on choosing an innovative
sauna climate unit!



TABLE OF CONTENTS

Safety information _____	10
INSTRUCTIONS FOR USE	
Instructions for use _____	14
Sauna climate control _____	14
Using the Air Solo _____	14
Instructions for using Himalayan salt _____	15
Warnings _____	16
Maintenance and repair _____	17
Warranty _____	18
INSTALLATION INSTRUCTIONS	
Installation _____	20
Dimensions of the Saunum AirSolo models _____	21
Saunum AirSolo model installation distances _____	22
Components of the Saunum AirSolo device _____	24
Saunum AirSolo model dimensions _____	24
Saunum AirSolo model installation distances _____	26
Electrical connections _____	30
Installation report _____	39



SAFETY INFORMATION

These installation and operating instructions are intended for the owner or maintenance provider of the sauna, as well as the electrician responsible for installing the Air Solo. After installing the Air Solo, the manual must be handed over to the owner or the maintenance provider. Before using Saunum AirSolo please read the installation and safety instructions.

The **Saunum AirSolo** sauna room climate unit manufactured by Saunum Saunas may not be taken into use before reading the installation and safety instructions!

The Air Solo is designed for mixing layers of air and, harmonizing the temperatures of the indoor climate of the sauna and, as an added function, releasing salt into the indoor air from the Himalayan salt included in the set. The special ventilator in the Air Solo generates air flow that harmonizes the upper and lower air layers of different temperatures in the heated sauna and makes the temperature smooth and even.

Caution! It is forbidden to use the sauna climate device with electrical heater and wood burning heater above allowed temperature. This may cause overheating and fire risk!

This manual is intended only for home use saunas. Separate rules apply to public saunas, conditions have to be specified with the manufacturer.

The manufacturer is not responsible for incorrect use of the sauna climate device!

Do not use the Device for anything other than the intended purpose!

READ, SAVE AND FOLLOW ALL INSTRUCTIONS.



Make sure you do not have allergies and contraindications to a saline environment. Consult a doctor if you have concerns or questions.

Saunum Saunas will not be held liable for various side effects to the health of the user of the Air Solo. Using Himalayan salt in the Air Solo is an optional added function which may be left unused without any effect on the functioning of the Air Solo in harmonizing the climate of the sauna room.

In the case of any health concerns, the Himalayan salt tray can be removed from the base tray and the Air Solo can be used for only mixing the layers of air.

CAUTION! The Air Solo may only be activated for the duration of the sauna bath. The Air Solo must be switched off when heating the sauna and during breaks between steam baths!

Do not pour water into the housing or ventilation openings of the Air Solo or use the Air Solo in a room where there

is water flowing on the floor or where flammable/explosive gases may leak into the air.

The Air Solo may not be used if any housing components have been removed and/or the electrical wiring diagram has been altered.

WARNING! To reduce the risk of injury, do not permit children to use this product unless they are closely supervised at all times. Children must not be allowed access to the Air Solo or to play with the Air Solo.

The Air Solo must be installed by a person who is qualified to perform electrical work. The Air Solo must be connected to the power grid by using permanent wiring that is suitable for the ambient temperature conditions. The connecting terminals of the Air Solo must be equipped with protective grounding (GND). The cross-sectional area of the wire must be at least 18-AWG. The Device must be powered from a power circuit that is protected with overcurrent and residual-current devices. Supply voltage: 120 V / 0, 31A - 60 Hz.



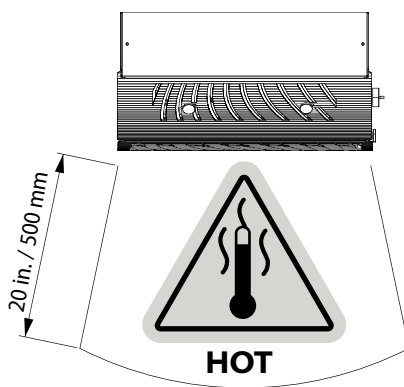
WARNING TO REDUCE THE RISK OF FIRE, ELECTRIC SHOCK, OR INJURY TO PERSONS, OBSERVE THE FOLLOWING:

- a) Installation work and electrical wiring must be done by qualified person(s) in accordance with all applicable codes and standards. Including fire-rated construction.
- b) Use this unit only in the manner intended by the manufacturer, if you have questions, contact the manufacturer.
- c) Before servicing or cleaning unit, switch power off at service panel and lock panel to prevent power from being switched on accidentally. When the service disconnecting means cannot be locked, securely fasten a prominent warning device, such as a tag, to the service panel.

CAUTION! The Air Solo housing has sharp corners and edges against which you may injure yourself if you are not careful.

CAUTION! The Air Solo must be installed so that the exhaust opening is not directed towards the heater.

CAUTION! Sauna users must keep all body parts (feet, arms, legs, hands, etc.) at least 20 in. / 500 mm away from the air output during sauna session.



TRANSPORT AND STORAGE

The Air Solo is packaged by the manufacturer in a way that ensures the preservation of the Air Solo under normal transport conditions. The Air Solo must not be dropped, tossed or stored under heavy goods. Store the Air Solo in a dry room that is protected from weather effects.



INSTRUCTIONS **FOR USE**

The Air Solo is designed for harmonizing the climate of the sauna room during a sauna session.

Before using the Air Solo for the first time, check:

- compliance of the wiring with the requirements;
- compliance of the supply voltage with the rated voltage of the Device
- the condition of the protective grounding (GND);
- the mountings on the Air Solo housing;
- the wall mountings of the Air Solo;
- the condition / presence of overcurrent and residual-current protection devices;
- if the heat equalizing module can rotate freely;
- if all tools and residues of the materials used during installation are removed from the housing of the Air Solo.

When starting the Air Solo, check:

- the direction of air flow – air must be drawn from the upper and blown out from the lower opening;
- for abnormal vibration or noise when the heat equalizing module is running;
- the lighting stability for LED equipped devices.

SAUNA CLIMATE **CONTROL**

The volume of air circulated by the Air Solo can be regulated by a rotary switch located on the lower right side of the Air Solo.

The climate control has four positions and can be turned both clockwise and counter-clockwise. When the bar on the climate control button points to the left, the heat equalizing module is turned off. Airflow speed increases by turning the climate control clockwise, you can choose between three different speeds. (Except AirSolo Wall with external climate control)

To control the air temperature in the sauna room, an air-cooling damper for sauna is located on the bottom front panel of the Device (see Figures 1C and 2B). The recommended setting is to keep the cooling damper 1/3 open. To cool the steam, try opening the damper incrementally. Try using different speeds to find the perfect indoor climate for your sauna.

USING THE AIR SOLO

The Air Solo is to be switched on immediately before entering the sauna room and switched off immediately. Air Solo may not be switched on when heating the sauna room or when there is no one in the sauna room, as the operation of the Air Solo will increase the temperature in the lower part of the



sauna room and the bench and floor may become too hot.

To ensure long service life of the Air Solo, make sure that the temperature in the sauna room at the lower part of the Air Solo does not exceed 176 °F. If this temperature is exceeded, the thermal protection will activate and the fan will stop; once the temperature falls below the activation level of the protection, the fan will automatically be switched on again.

The manufacturer will not be held liable for equipment failures resulting from exceeding the permitted operating temperature.

If your Air Solo is equipped with internal lights, the lights will activate at the same time as the heat equalizing module (see the marking on the packaging of the Air Solo) when the Air Solo is switched on.

If your Air Solo is wall-integrated and equipped with an external climate control switch for speed control, please keep in mind the following requirements:

- The external climate control may only be installed outside the sauna and washing room, e.g. the changing room, preferably next to the door, so that the Air Solo can be conveniently switch on and off.

- The climate control has three positions for selecting the desired airflow intensity.
- If the Air Solo is equipped with internal lighting, a separate switch (optional) must be used to switch it on.

INSTRUCTIONS FOR USING HIMALAYAN SALT

The sauna climate unit comes with Himalayan salt. The use of Himalayan salt in the Air Solo is optional and does not affect the basic function of the Air Solo.

To use the Himalayan salt, they must be placed in the Himalayan salt tray located between the air output grille and the fan. Make sure that the Himalayan salt is placed correctly and do not impede the rotation of the air output.

To place or remove the Himalayan salt (see Figures 1D and 2C), loosen the two fastening bolts on the air output grille and lower the grille on its hinges. Do not use excessive force! After placing or removing the Himalayan salt, shut the air output grilles and fasten it with two bolts.

The Air Solo may only be used if the air output grille is installed!



WARNINGS

- Remaining in the sauna room for an extended period of time raises your body temperature, which can be dangerous to your health!
- Do not allow children, disabled or ill persons in the sauna room unattended!
- Consult a doctor regarding medical contraindications to sauna bathing!
- Consult your doctor regarding medical contraindications to salt treatment!
- Make sure you are not allergic to salt treatment. Saunum is not responsible for the side effects of salt treatment!
- Consult a pediatrician or family physician about allowing children to take a sauna bath!
- Use caution when moving in the sauna as the bench and floor can be slippery!
- Do not go to the sauna under the influence of alcohol, drugs, or narcotics!
- Do not sleep in a hot sauna room!
- Salt and humid climates may cause an oxide layer (rust) to form on the metal surfaces of the heater!
- Make sure you have proper ventilation in the sauna room. Saunum is not responsible for possible corrosion damage caused to the sauna equipment by salt. If necessary, consult a specialist!
- Do not hang towels and clothes to dry in the sauna room – this may cause a fire hazard!
- Excessive moisture can damage electrical equipment!
- Electrical components should not be exposed to water.
- Maintenance, and installation, should be performed in a cool and dry environment.

Caution! Do not leave the fan of the sauna climate unit running when you are not in the sauna room – doing so will result in excessive energy consumption and the bench may become too hot!



MAINTENANCE

AND REPAIR

CAUTION! Before servicing and cleaning the Air Solo, the power circuit of the Air Solo must be disconnected from the power and utilities and the moving parts of the device must come to a complete stop.

Before servicing and cleaning the Air Solo, make sure that:

- the Air Solo has been disconnected from the power and utilities (switched off at the overcurrent protection device in addition to the power switch of the Air Solo);
- the Air Solo's heat equalizing module has stopped completely;
- the required occupational safety and personal protective equipment is used when performing the maintenance;
- the connecting cables are undamaged. If any damage to cables is detected, the cables must be replaced by a qualified electrician in accordance with the applicable standards and requirements before continuing maintenance and cleaning work.

The Air Solo housing can be cleaned with a cloth dampened with water.

Do not use a pressure washer or running water to clean the Air Solo! Do not use chemical cleaners or solvents to clean the Device!

Excessive dirt can cause imbalance of the heat equalizing module which increase the noise level when the Air Solo is operating. Damaged or bent heat equalizing modules may also increase the noise level. Make sure that no foreign objects enter the operating area of the heat equalizing module.

Generally, the heat equalizing module does not need to be cleaned more than once a year. Only qualified persons may clean the fan.

Using compressed air to clean the fan may permanently damage the heat equalizing module!

Bearings are maintenance-free and must be replaced if malfunctions occur.

Make sure that there are no foreign objects in the air vents of the heat equalizing of the Air Solo. The Air Solo is not meant to be cleaned by children.

If Himalayan salt is used with the Air Solo, it is recommended that the state of wear of the Himalayan salt be checked once per year (see Figures 1D and 2C).

When the diameter of the salt has decreased by more than a half, the salt must be replaced. To replace the salt, remove the salt tray and wash the tray under running water to remove any salt residue. Install the container and place new salt in their slots.

In the event of any malfunctions involving the heat equalizing module and lighting, stop using the Air Solo immediately and have it inspected by a qualified person.



GENERAL WARRANTY CONDITIONS FOR SAUNUM PRODUCTS

With the Saunum Equipment Warranty, Saunum guarantees that the product will be free from materials and manufacturing defects for a specified period after the date of purchase. In the event of a defect in the Air Solo during the warranty period due to the use of low-quality materials or low quality of assembly, the recommended repair partners of Saunum will repair or replace the Air Solo or its defective part without charging for labor and spare parts under the conditions presented below. Saunum reserves the right to decide whether to replace the defective product component or replace the Air Solo with a new one. Replaced defective product components remain the property of Saunum.

Warranty conditions:

1. The warranty is only valid if a completed installation report is submitted with the claim;
2. A warranty period of two (2) years applies to the Air Solo if it is used in a residential sauna;
3. A warranty period of one (1) year applies to the Air Solo if it is used in a commercial sauna.

The warranty does not cover:

1. Routine maintenance and cleaning of the Air Solo, and replacing components due to normal wear and tear;
2. Adapting or modifying the Air Solo to use it for purposes other than those stated in the operating instructions;
3. Risks associated with transport;
4. Damage caused by misusing the Air Solo;
5. Damage caused by improper installation of the Air Solo;
6. Accidents, lightning, water, fire, improper ventilation or any other factor beyond the control of Saunum;
7. Faults caused by the use of Himalayan salt not recommended by Saunum;
8. Himalayan salt.



The maintenance instructions for the Air Solo are given in the user manual of the Air Solo.

Caution! The Air Solo may only be connected to the power and utilities by a professional electrician in accordance with the applicable regulations.

Read the entire user guide carefully and thoroughly before using the Air Solo and keep it in a safe and easily accessible place for future reference.



INSTALLATION

Caution! Read the Safety Information before beginning installation (see pp 6–7)!

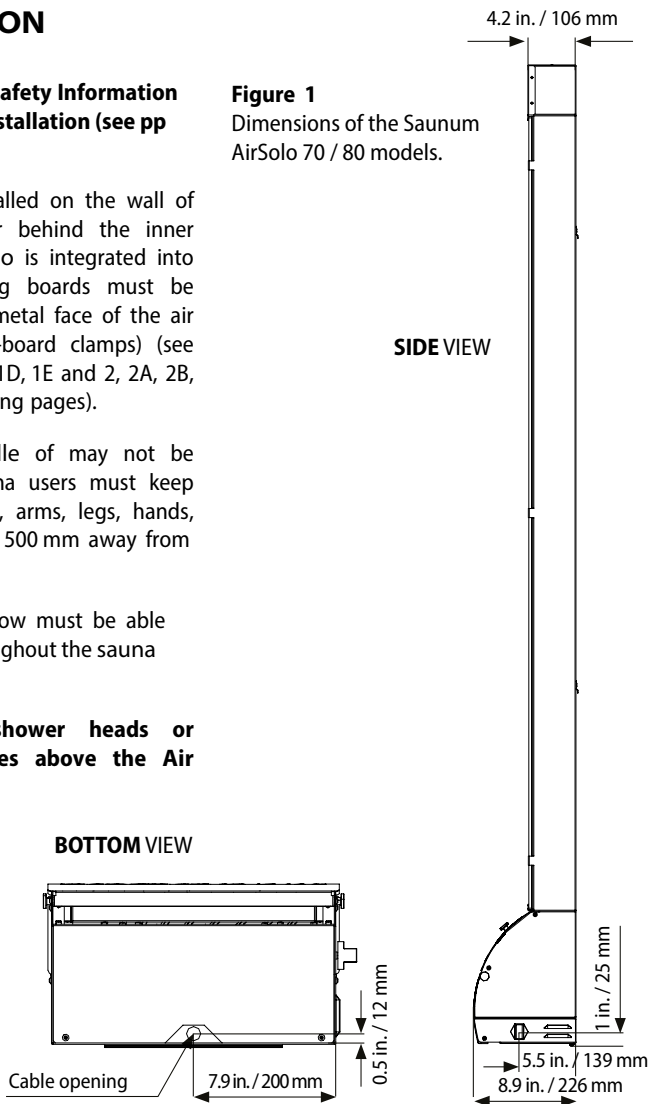
The Air Solo is installed on the wall of the sauna room or behind the inner lining (if the Air Solo is integrated into the wall, the lining boards must be secured to the sheet metal face of the air duct with weather-board clamps) (see Figures 1, 1A, 1B, 1C, 1D, 1E and 2, 2A, 2B, and 2C on the following pages).

The air output grille of may not be obstructed and sauna users must keep all body parts (feet, arms, legs, hands, etc.) at least 20 in. / 500 mm away from the fan.

The discharged air flow must be able to spread freely throughout the sauna room.

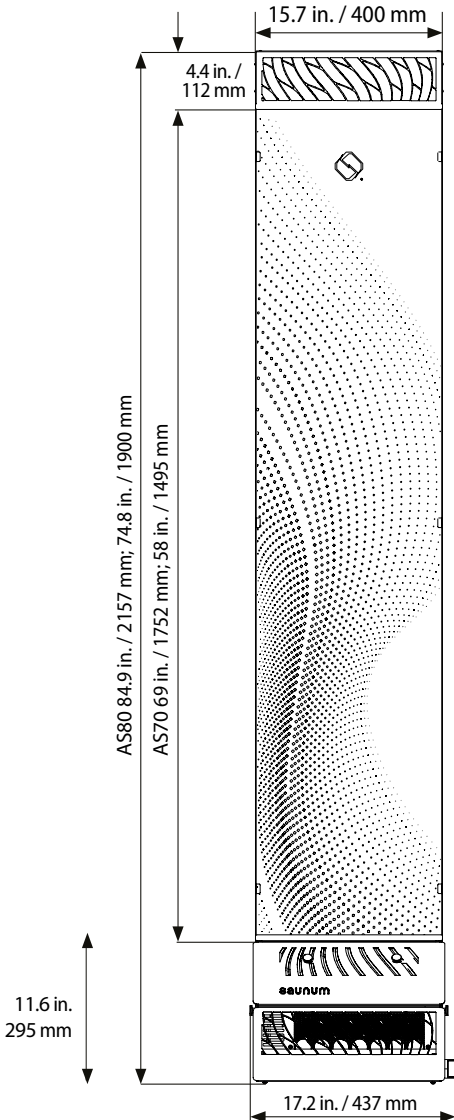
Do not install shower heads or water spray devices above the Air Solo!

Figure 1
Dimensions of the Saunum AirSolo 70 / 80 models.

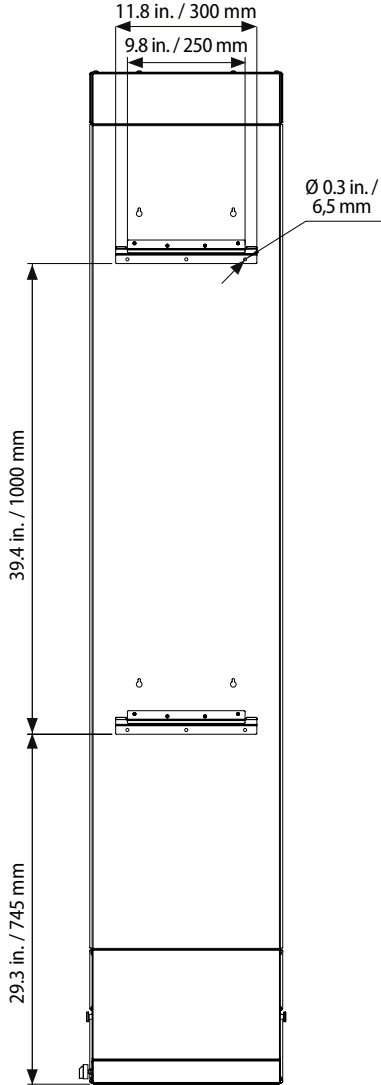




FRONT VIEW



REAR VIEW



DIMENSIONS OF THE AIRSOLO 70/80



Figure 1A – Saunum AirSolo 70 / 80 model installation distances.

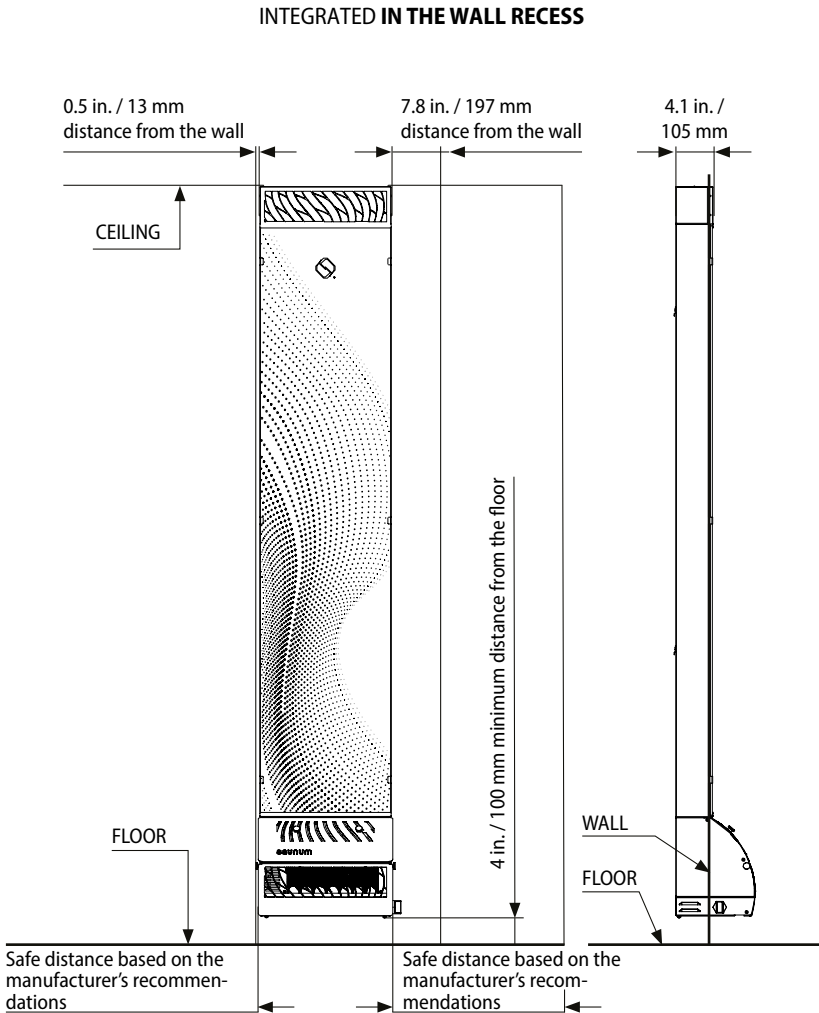




Figure 1B – Saunum AirSolo 70 / 80 model installation distances.

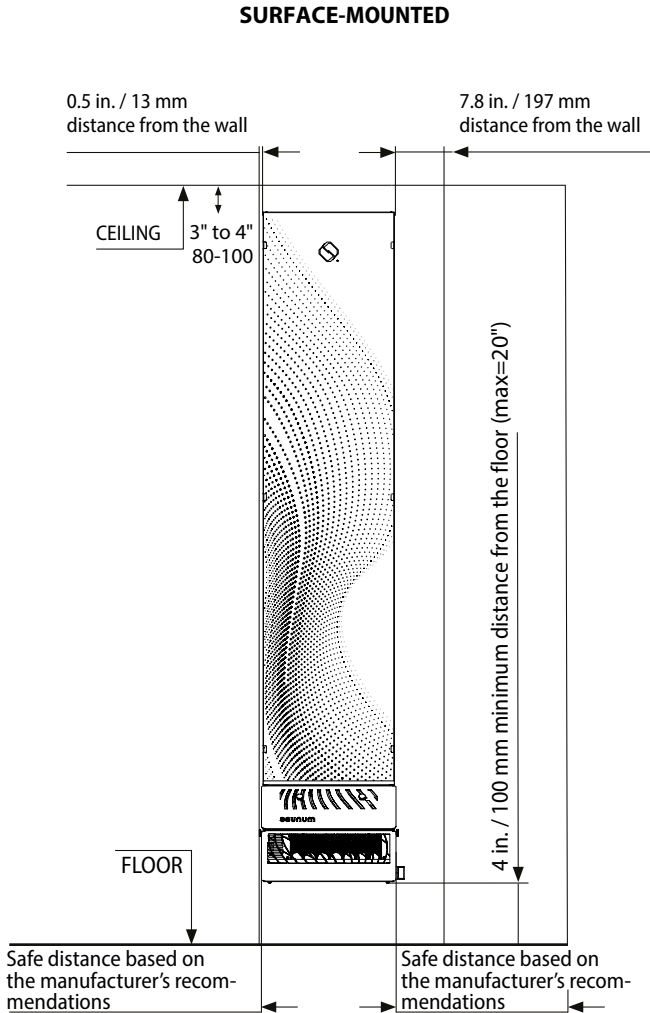
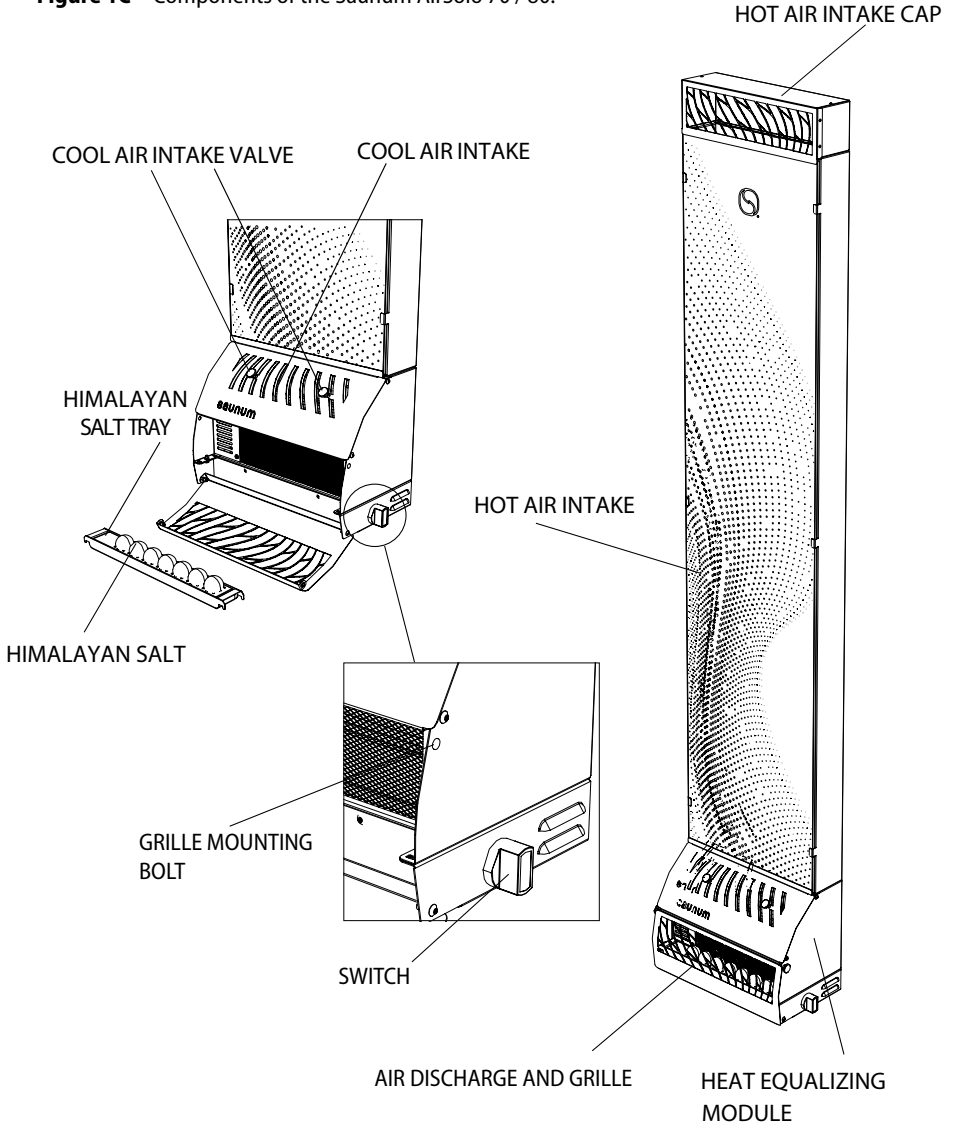




Figure 1C – Components of the Saunum AirSolo 70 / 80.





The Air Solo works most efficiently when the edge of the hot air intake opening is adjacent to the ceiling of the sauna room (model with a hot air intake cap). If the Air Solo is not equipped with a hot air intake cap, the Air Solo should be installed so that the upper edge remains 3–4 in. / 80–100 mm below the ceiling. The lower edge may not be closer than 4 in. / 100 mm. to the floor to prevent the water on the floor from coming into contact with the electrical wiring of the Air Solo.

The Air Solo is designed for wall mounting using the hanging strips included in the set. The wall in the installation spot must be able to carry the weight of at least 77 lb / 35 kg and allow the supplied hanging strips to be fastened with screws. The hanging strips are attached to the wall of the sauna room, each with at least two screws. The Air Solo is then lifted onto the wall so that both the upper and lower strips slide between the strips attached to the back of the Air Solo.

Figure 1D – Saunum AirSolo 70 / 80 model installation.

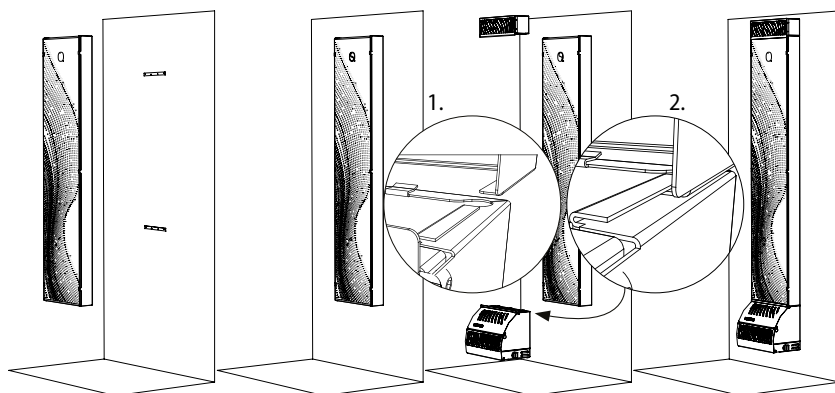
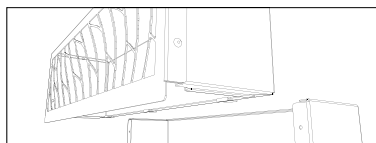
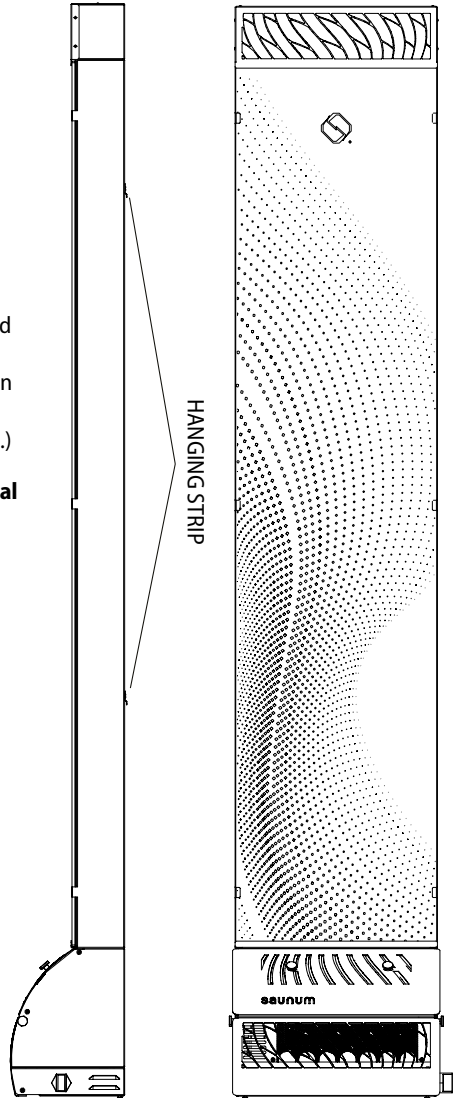




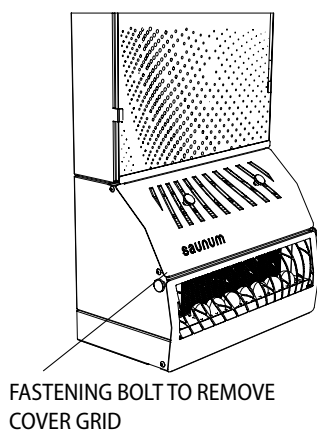
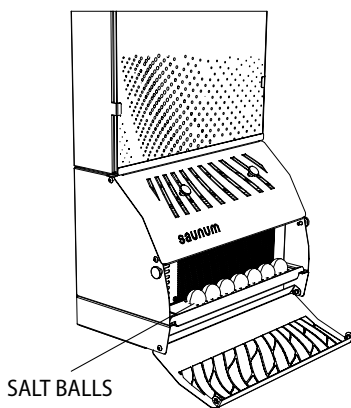
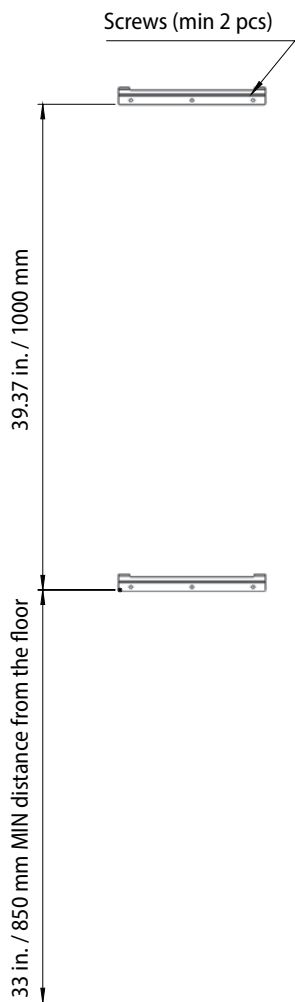
Figure 1E – Recommended installation of the Saunum AirSolo 70 / 80 model using a hanging strip.

1. Install the strips supplied with the Air Solo on the wall. Use anchors if necessary.
2. Hang the Air Solo on the wall-mounted strips. Make sure that the eyelets on the back of the Air Solo rest equally on both slats. (If necessary, use a spirit level to ensure that the Air Solo is level.)
3. **Check the Air Solo for any external damage. It is forbidden to use a damaged Air Solo!**





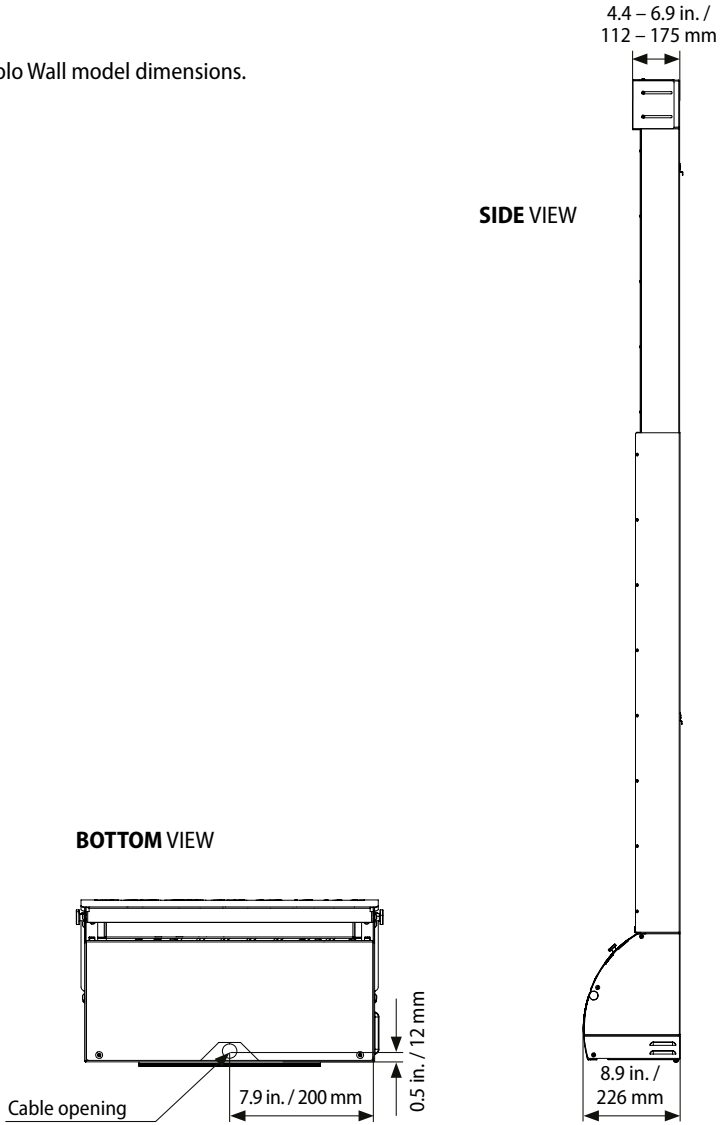
4. Install the salt balls. The salt balls are placed in the Device after it has been mounted on the wall. To install the balls, open the lower grille by removing the two hand-turned bolts. Place the balls in their slots on the tray.

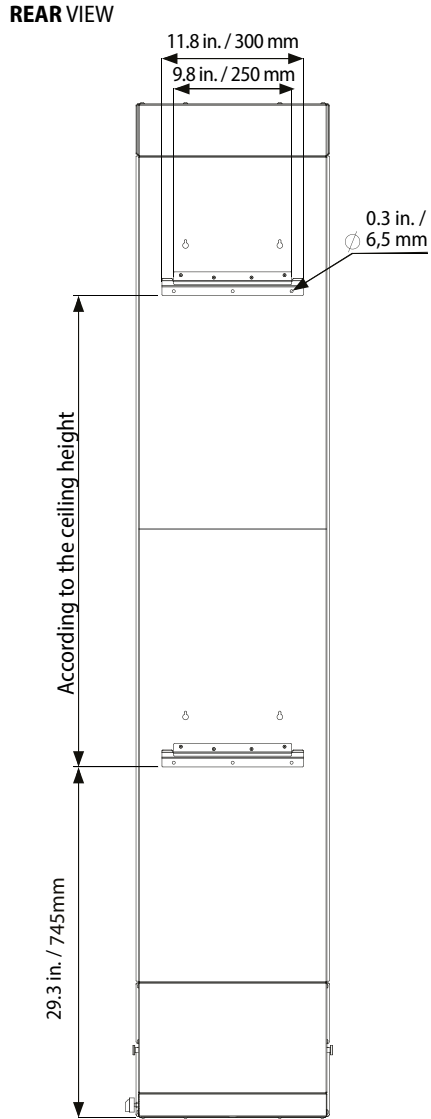
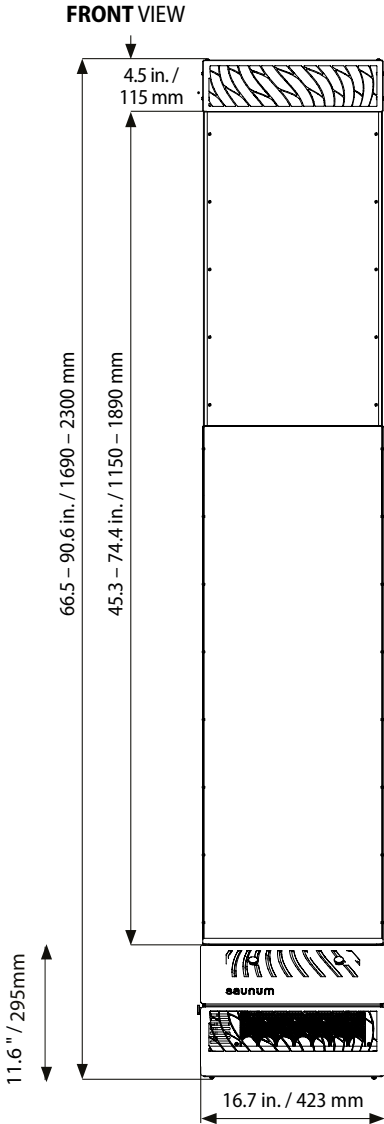


DIMENSIONS OF THE AIR SOLO WALL



Figure 2
Saunum AirSolo Wall model dimensions.





DIMENSIONS OF THE AIR SOLO WALL



Figure 2A – Saunum AirSolo Wall model installation distances.

WALL MOUNTED INSIDE OF WALL

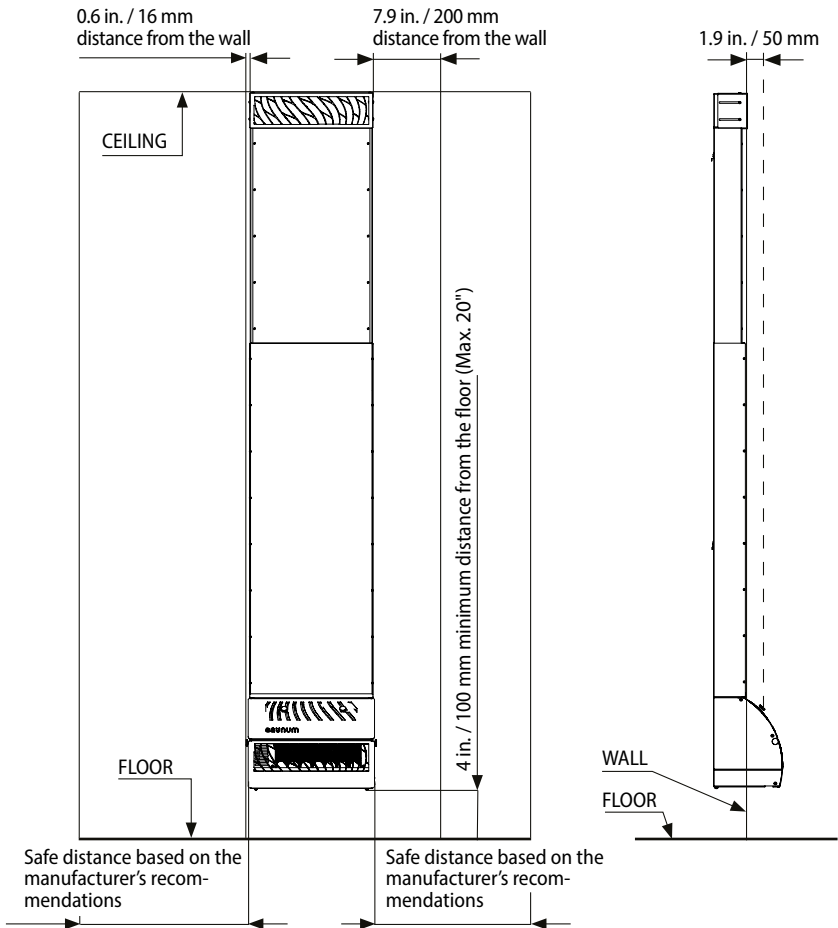




Figure 2B – Components of the Saunum AirSolo Wall model device.

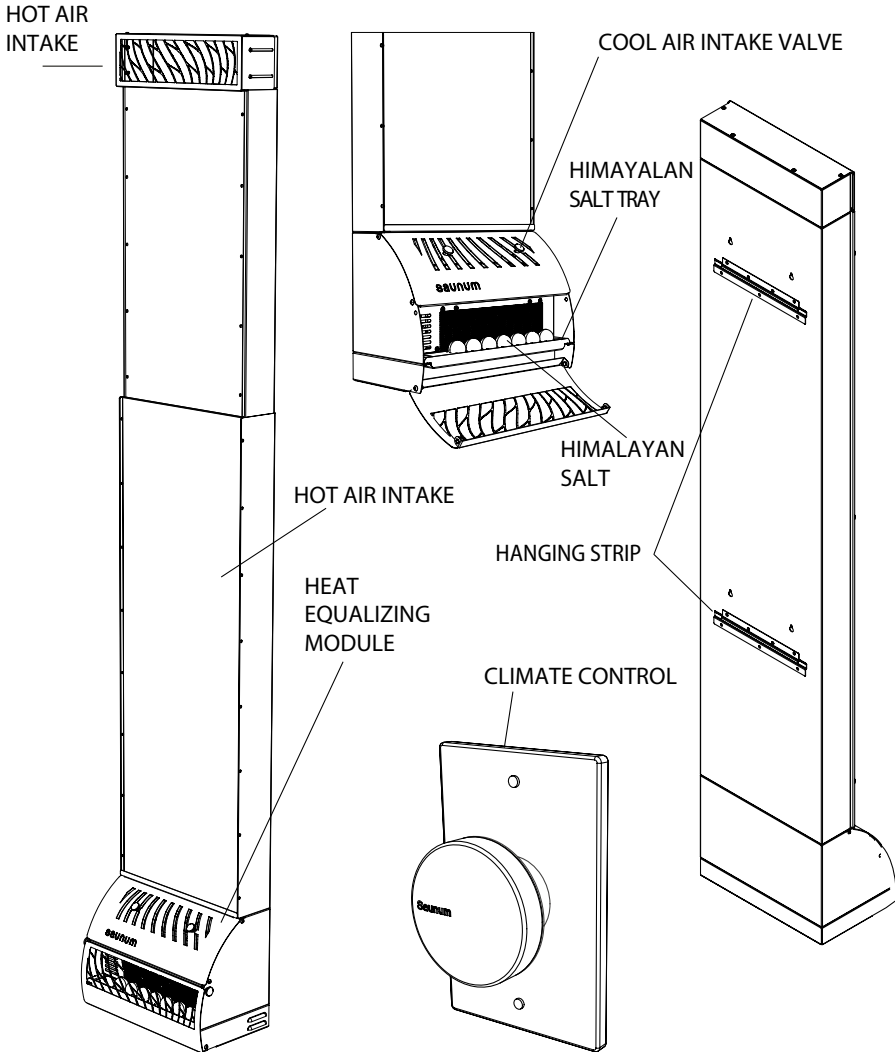
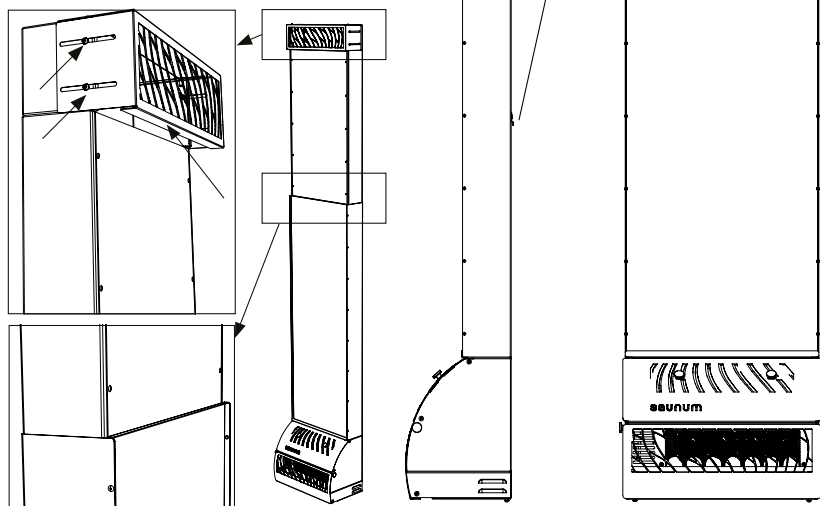




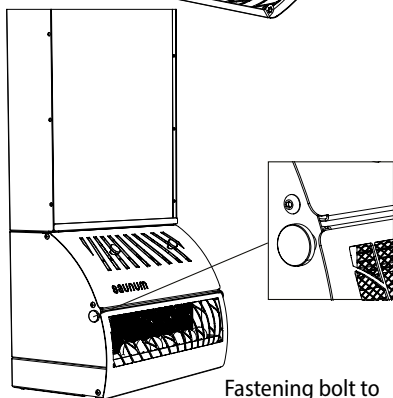
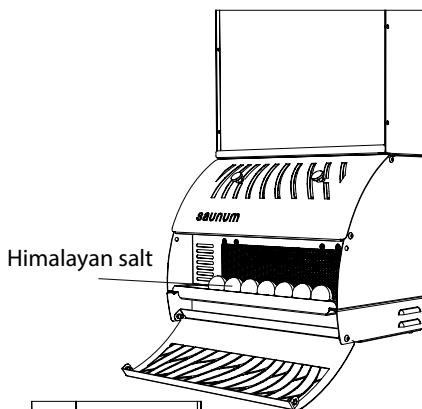
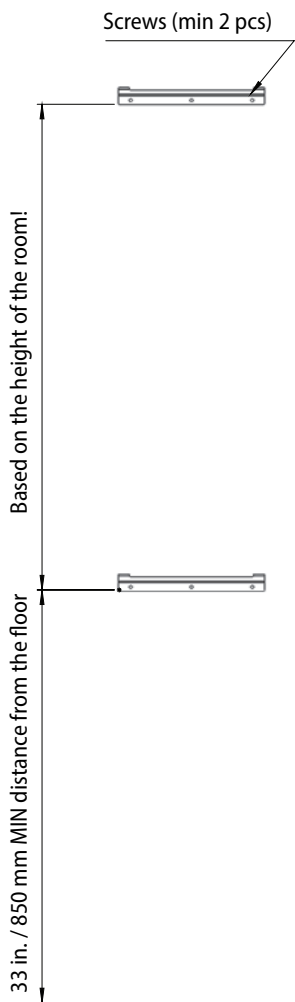
Figure 2C – Recommended installation of the Saunum AirSolo Wall model using a hanging strip.

1. Install the strips supplied with the Air Solo on the wall. Use anchors if necessary.
2. Hang the Air Solo on the wall-mounted strips. Make sure that the eyelets on the back of the Air Solo rest equally on both slats. (If necessary, use a level to ensure that the Air Solo is level.)
3. **Check the Air Solo for any external damage. It is forbidden to use a damaged Device!**
4. Before using the Air Solo, cover all un-covered openings using the specified aluminum tape to do so.





5. Place the Himalayan salt. The salt are placed in the Air Solo after it has been mounted on the wall. To place the salt, open the lower grille by removing the two hand-turned bolts. Place the salt in their slots on the Himalayan salt tray.





ELECTRICAL CONNECTIONS

ATTENTION! The Air Solo must be installed by a person who is qualified to perform electrical work, in accordance with the applicable standards and requirements.

The Air Solo must be permanently connected to the power grid using a screw terminal and a cable that is suitable for the temperature conditions in compliance with the electrical connection diagrams presented in this manual (Figures 3, 3A, 4, 5 and 6 on the following pages).

The outer diameter of the cable must not exceed 0.4 in. The connection terminal of the Air Solo must be equipped with protective grounding

(GND) with a minimum cross-sectional area of the wire being 18-AWG/90°C. The Air Solo must be powered by a 120 VAC / 0,31 A 60 Hz supply circuit which is protected with a 1A overcurrent protection device, and the supply circuit of the Air Solo must also be equipped with a residual current device to ensure the safety of people in the sauna room.

The lighting of the sauna must be connected to either an external or internal switch. The power circuit for the external light switch must also be equipped with residual-current and overcurrent protection devices. The lighting and fan circuits of the Device are connected to external switches, the

supply circuits of which are equipped with residual-current and overcurrent protection devices. The power cable must enter the Air Solo housing vertically from below to prevent water from entering the Air Solo along the cable. The external insulation layer of the cable may only be peeled off in the section which remains inside the housing of the Air Solo.

The wiring diagram only applies to an illuminated Air Solo with an external switch!

Perform the wiring in accordance with the instructions provided for in the wiring diagram of the Air Solo.

The circuit must include overcurrent protection AirSolo!

Only connect via-current and overcurrent Air Solo!

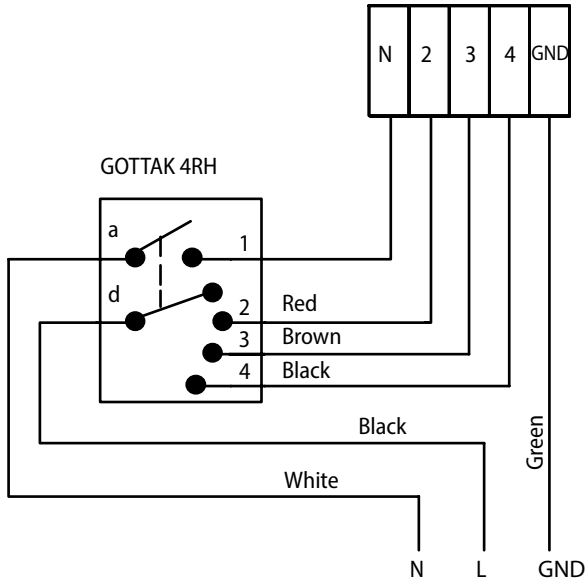
The power cable being used must be designed for stationary electrical installations and compliant with the requirements for the electrical installation installed in the steam room. The cross-section of the power cable must be 18-AWG/90°C.

Insert the power cable through the hole in the bottom of the Air Solo, in accordance with the installation instructions.

The power cable must not be left lying on the floor of the sauna room.



Figure 4 – Connecting the power cable to a Air Solo equipped with an external climate control.



The circuit must include GCFI and overcurrent protection devices!

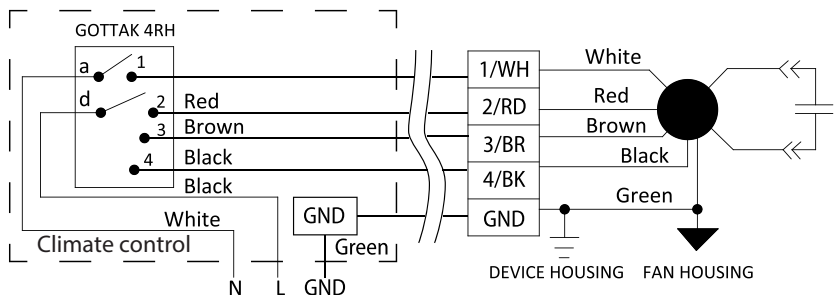
Heat equalizing module power supply. The circuit must include GCFI and overcurrent protection devices!

Perform the wiring in accordance with the instructions provided for in the wiring diagram of the Air Solo.

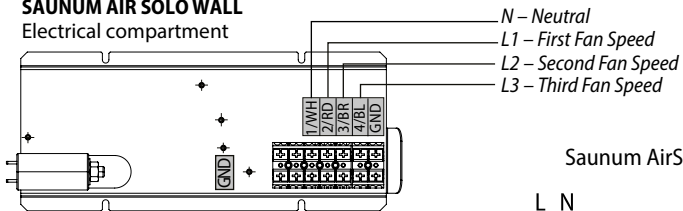


Figure 5 – Wiring diagram and electrical component board.

Saunum AirSolo Wall with external climate control

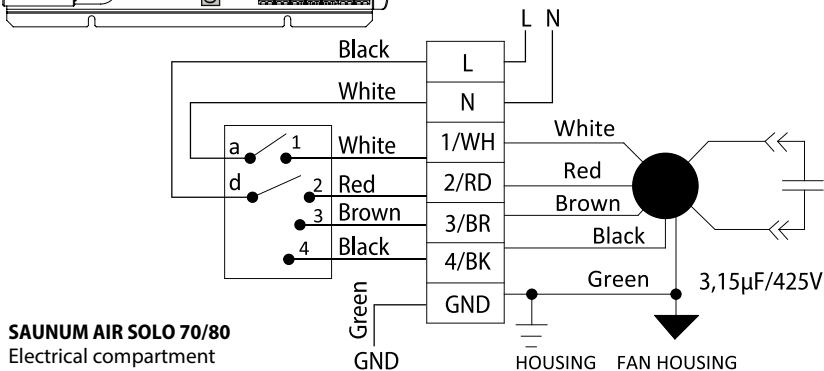


SAUNUM AIR SOLO WALL Electrical compartment

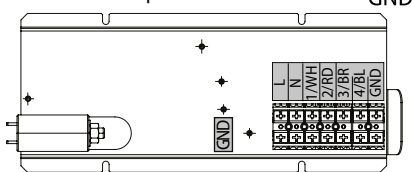


- N – Neutral
- L1 – First Fan Speed
- L2 – Second Fan Speed
- L3 – Third Fan Speed

Saunum AirSolo 70/80



SAUNUM AIR SOLO 70/80 Electrical compartment

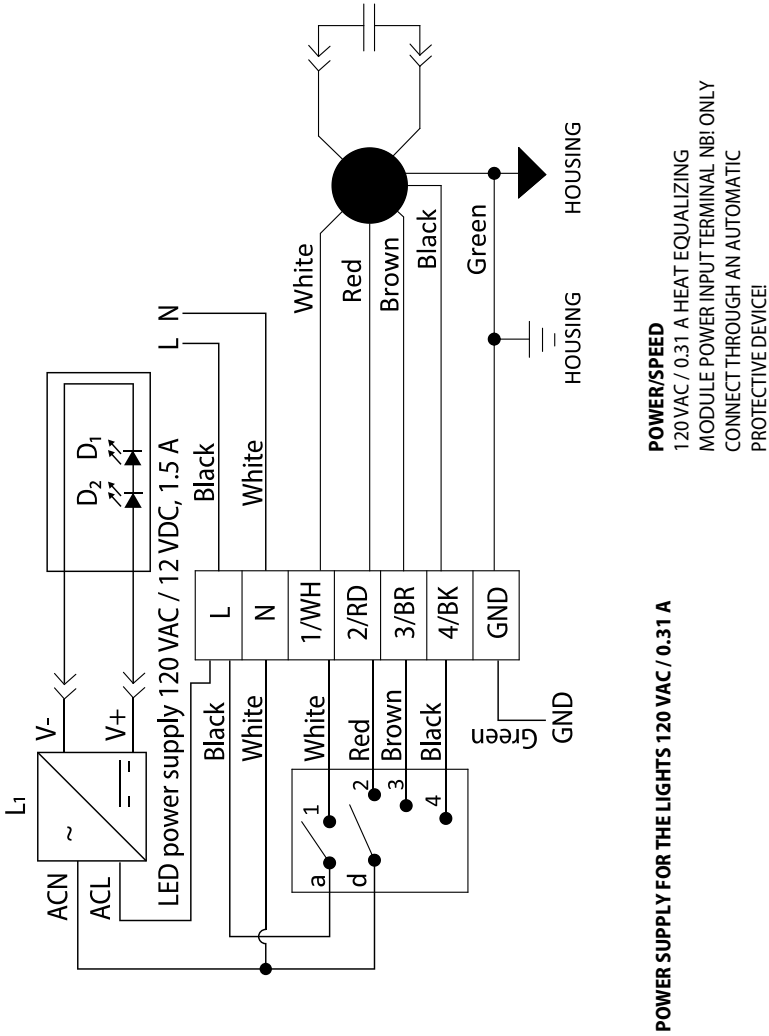


POWER/SPEED

120 VAC / 0.31 A FAN POWER INPUT TERMINAL CONNECTION ONLY PERMITTED THROUGH AN AUTOMATIC PROTECTIVE DEVICE!

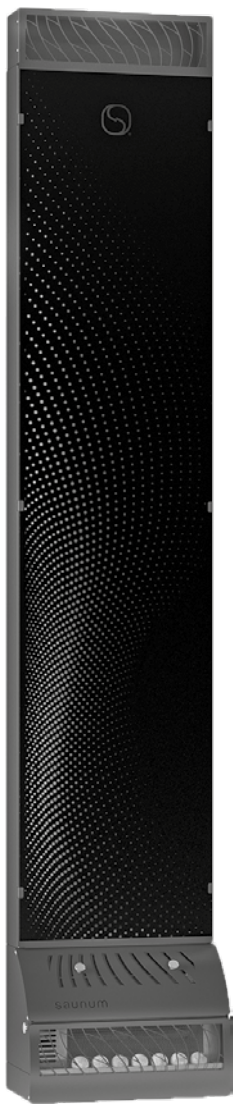


Figure 6 – Wiring diagram: Air Solo, equipped with illumination and a switch.





Air Solo - 70
Air Solo - 80



Air Solo - Wall





INSTALLATION REPORT

INSTALLATION REPORT

Purchase date: _____

Equipment _____

Sticker / serial number:

Place of installation: _____

Date of installation: _____

Installed by: _____

Checked: _____

Date, signature: _____

Description of work performed: _____

All details are available for installation _____

No color defects or dents _____

Mounted on the wall or floor according to the instructions _____

The electrical connections have been made in accordance with the installation instructions _____

The three stages of the climate control are running / in the correct order

NOTES: _____

Customer contact (name, e-mail): _____

Work accepted: _____

Warranty start date: _____

TO BE COMPLETED BY THE CUSTOMER



Manufacturer: Saunum Saunas OÜ
Address: Suur-Paala 19
11415 Tallinn, Estonia

certifies that the product:

Indoor climate unit in the sauna sauna room

complies with the requirements:

UL 875, Electric Dry-Bath Heaters, Edition 9, Revision Date 01/04/2021;
CSA C22.2 No. 164, Electric Sauna Heating Equipment, Edition 2,
Issue Date 02/2018.

These products do not contain hazardous substances in excess of 0.1% (SVHC) and meet the requirements of the REACH Regulation (1907/2006/EU REACH XVII) and comply with the requirements of the RoHS Directive (2011/65/EU, RoHS2 and 2015/863/EU, RoHS3)