

4FT 90" Eurofit Wall

Product Parts

- 1 - Top Corner Poles (x2)
- 2 - Left Side
- 3 - Right Side
- 4 - Bottom Corner Poles (x2)
- 5 - Top & Bottom Center Poles (x2)
- 6 - Graphic
- 7 - Middle 2-pc Pole
- 8 - Feet (x2)
- 9 - Plastic Hinge Connector

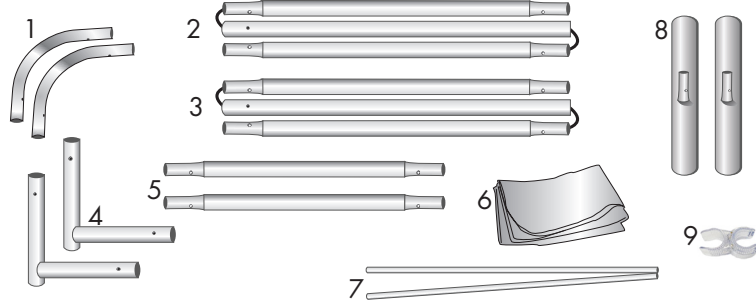

Display Set-Up

Step 1

Begin by removing all parts from the carry case and place on a clean, flat surface. Ensure you have all the components listed above.

Step 2

Assemble all the poles by connecting the corresponding numbers together while pressing the snap button as shown.

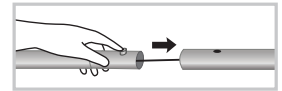
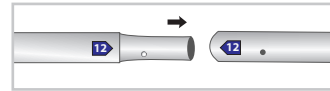

Step 3

Continue to connect the poles illustrated in the image below.

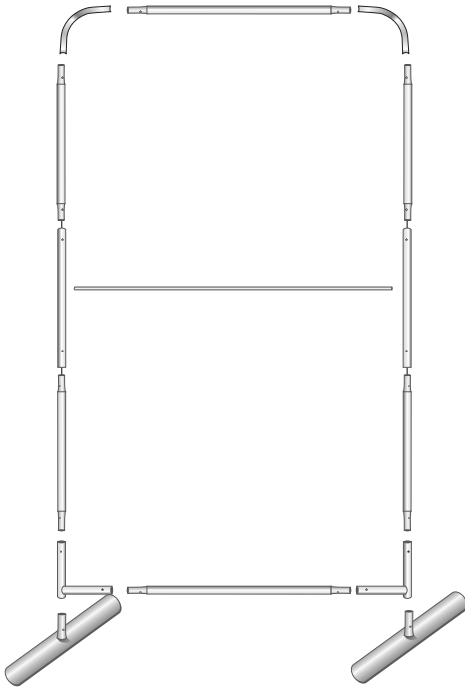

Step 4

Drape the Graphic (6) over the hardware as shown.

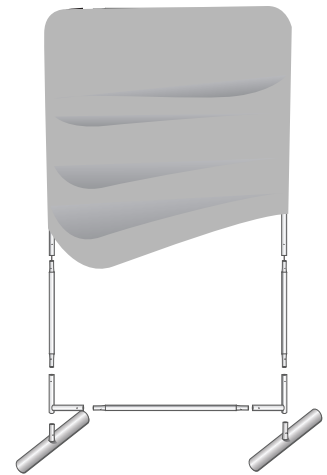

Plastic Hinge Connector

Used to connect all Eurofit Displays with 1.25" Diameter Poles.



Storage & Care

Place all product parts into Carry Case and store in a cool dry location. Recommended for indoor use only. Machine wash on gentle cycle using mild detergent. Tumble Dry No Heat. Do NOT dry clean, Do NOT Iron.