

Product Specifications Viewable Graphic Size: SEE PAGE 3

Item #	FRAME	**PLATES	SHELVES	Replacement Graphics-KIT	FABRIC GRAPHICS
342000	12 QUAD	40	2	342001	(4) C (1) E (1) G (2) H
342002	9 QUAD	32	3	342003	(4) A (3) H
342004	9 QUAD	32	3	342005	(2) A (2) H (2) I
342006	9 QUAD	32	2	342007	(1) E (1) F (1) G (1) H
342008	9 QUAD	32	3	342009	(1) D (2) H (1) I
342010	3 QUAD	16	1	342011	(2) A (1) H
342012	3 QUAD	16	NONE	342013	(3) A
342014	6 QUAD	24	NONE	342015	(2) A (1) F (1) G
342018	12 QUAD	40	2	342019	(2) B (1) F (2) H
342020	8 QUAD	32	2	342021	(2) B (2) C (1) F

Product Parts for HARDWARE

- 1 - Geometrix Face Plates**
- 2 - Soft Case
- 3 - Frame
- 4 - Shelf

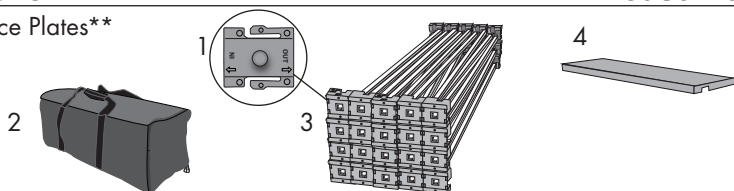

**Frame (3) should come with Face Plates already installed.

Product Parts for FABRIC GRAPHIC (skip to STEP 4)

- 5 - Fabric Graphics (qty varies)
see page 3 for layout of graphics



Optional Light Kit:

- 6 - LED Light Kit

- A. Light
- B. Plug
- C. hook/loop strips

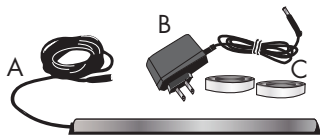

ALL PARTS COME IN THE KIT

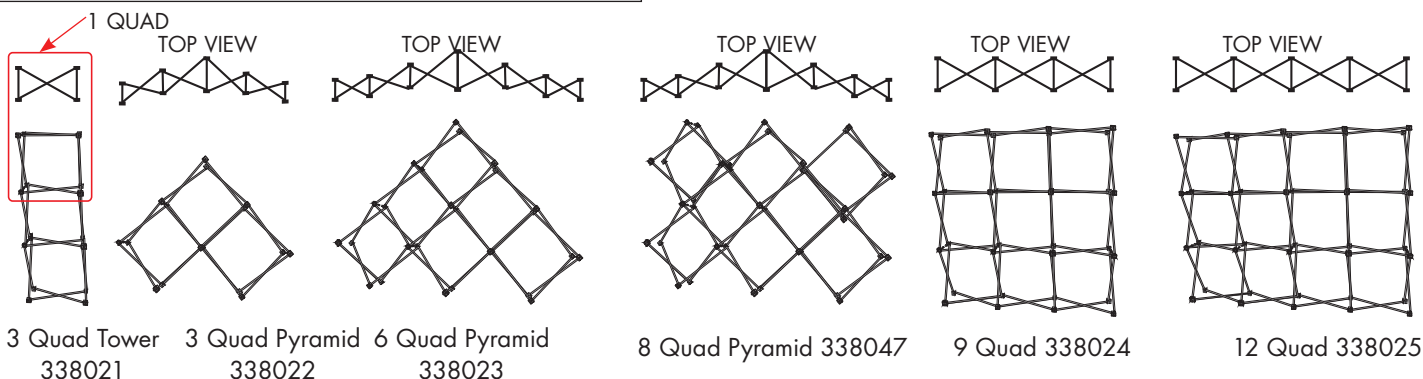

Display Set-Up

Step 1

Remove all parts from your Soft Carry Case (2) and place on a flat, clean surface. Review the Frame (3) and notice where the pivoting light clips are located. This will determine the TOP of the display.

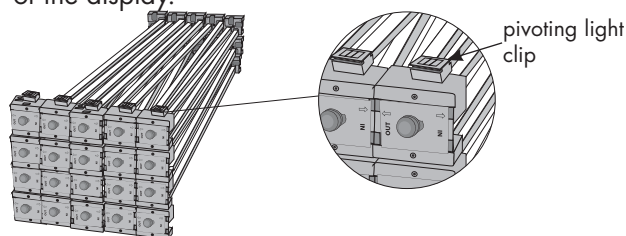

Step 2

Pull the Frame (3) up and out from the corners until it is fully expanded on the floor (or table).

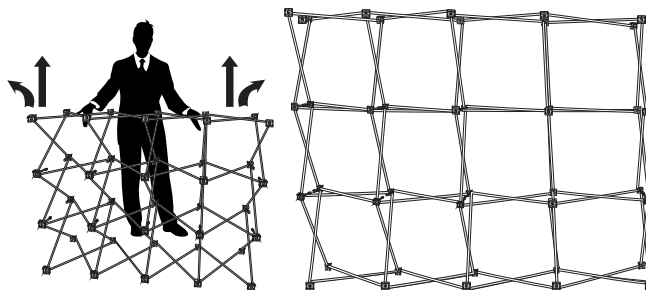

12 Quad (10' FRAME) shown

Step 3

Push all locking clips together to secure the Frame (3) in its expanded position.

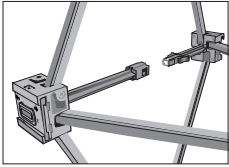

OPEN

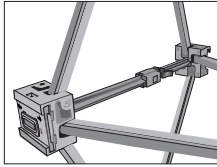

CLOSED

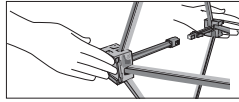

Pressure may need to be applied to secure.

Step 5

All shelves have an "X" shape on the underside that fits over the "X" shape on the Frame (3) "scissors".

Place the shelf notch (4) in its desired position making sure all four notches on the shelf sides fit over the Frame (3) "scissors".

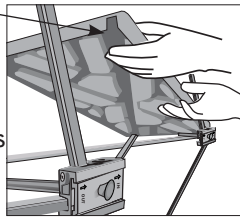

Step 4

Attach Fabric Graphics (5) to frame by locating hole slits in each corner and securing them around the plastic pin on the face plate. Repeat this step for each banner until all are secured to frame in desired locations (see pages 3 and 4)

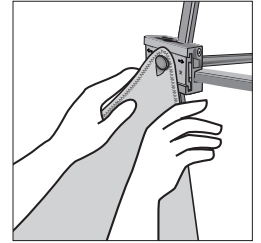

NOTE: STANDARD KITS SHOULD COME WITH FABRIC GRAPHICS ALREADY ATTACHED.

(Maximum Banners per peg is 6)

Optional Lighting:

Secure hook velcro to flat backside of LED light and loop velcro to under side of shelf. With both velcro strips secured, press light to underside of shelf-hook to loop attachment. Weave light cord to backside of frame and plug into on-site power source.

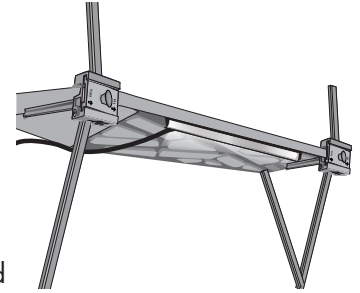

Frame Note:

TO REMOVE/REPLACE FACE PLATES:

If you need to replace or remove existing face plates, find the end of the Plate that is marked "OUT". **see NOTE if you cannot indicate which end is "OUT". Push Face Plate toward the "OUT" arrow.

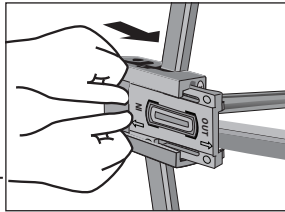

You may need to tap end with force to get it to start sliding.

** REMOVAL NOTE:

Most Graphic Face Plates (1) have arrows and the words "IN" and "OUT" stamped on them (all except the Splash Graphic Face Plates)

To Determine which end is "OUT", look at the end of the Face Plate. The "OUT" side has 2 bump outs. The "IN" side does not.

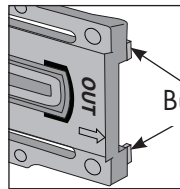
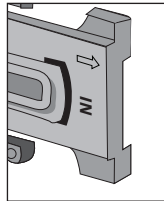

Bump outs

No "bump outs" indicates it is the "IN" side.

TO INSERT FACE PLATES:

Slide (with force) the Face Plates (1) into the hubs. Typically you will slide RIGHT to LEFT when looking at the face of the Frame.

Face Plates need to be installed on ALL front and back hubs for Deluxe Geometrix.

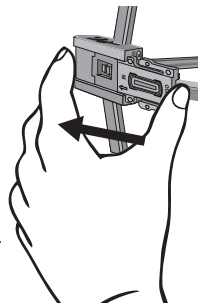

Disassembly Note:

For quick take down and future set up, you may leave graphic banners on Frame (3).

Unlock and **OPEN** all locking clips as shown in Step 3.

REMOVE ANY SHELVES then collapse Frame (3) will all Fabric Graphics (5) attached by pushing down and in on unit.

MAKE SURE ALL LOCKING CLIPS ARE IN OPEN POSITION before collapsing Frame (3)

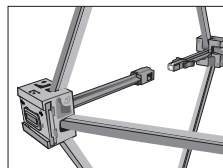

OPEN

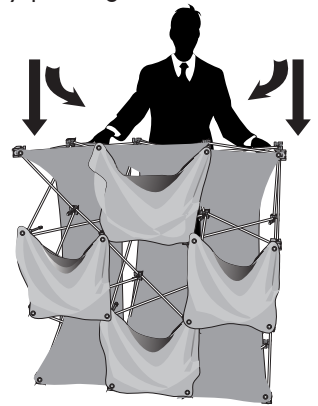

Storage and Care

Place all product parts into Carry Case and store in a cool dry location. Machine wash Cold gentle cycle. Machine Dry, NO HEAT, Do not Dry Clean, Do not iron.



Item# 342000, 342001

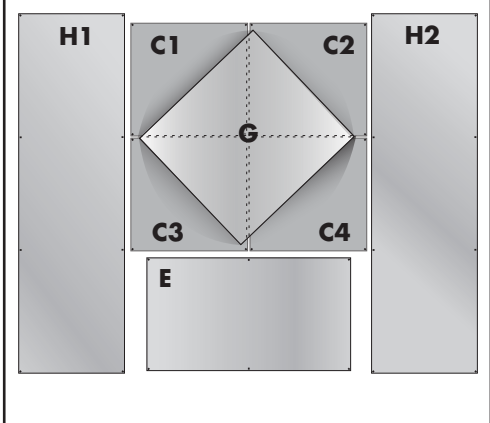

Item# 342002, 342003, 338084

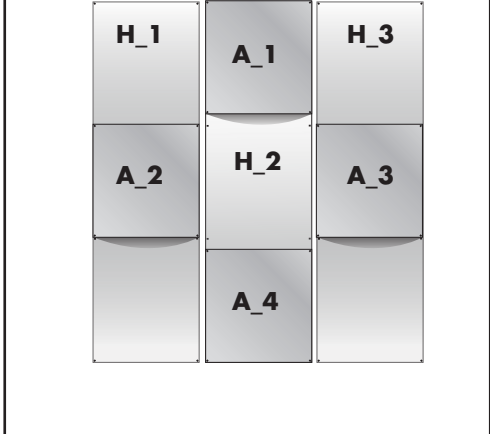

Item# 342004, 342005

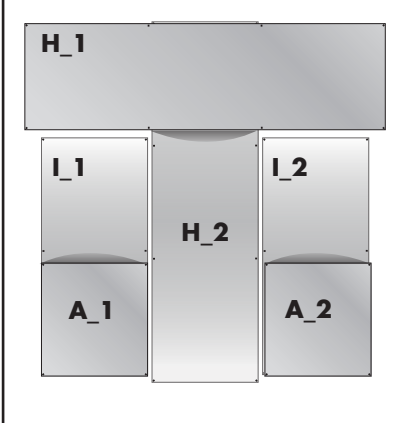

Item# 342006, 342007

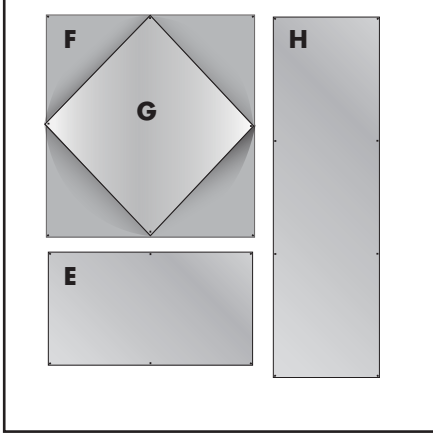

Item# 342008, 342009

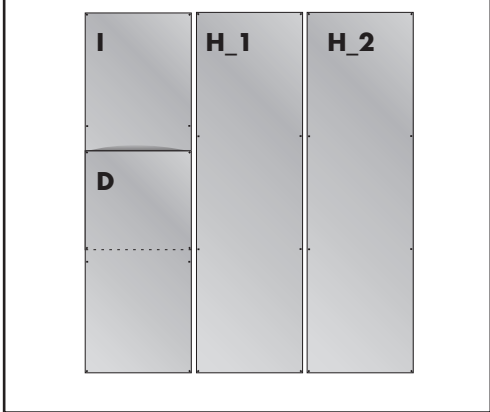

Item# 342010, 342011

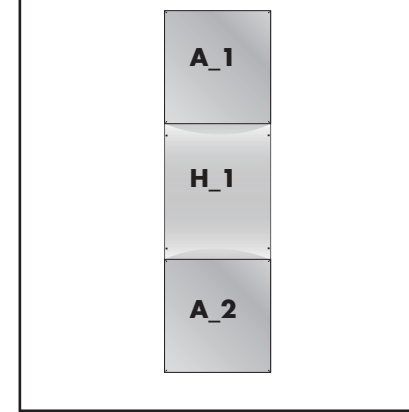

Item# 342012, 342013

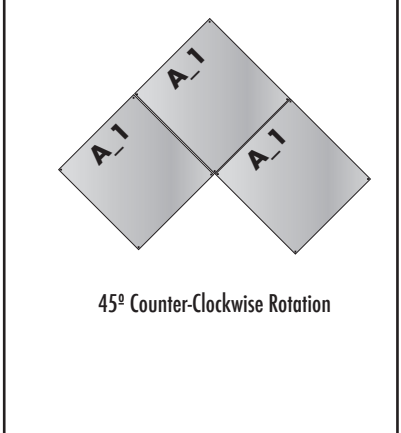

Item# 342014, 342015

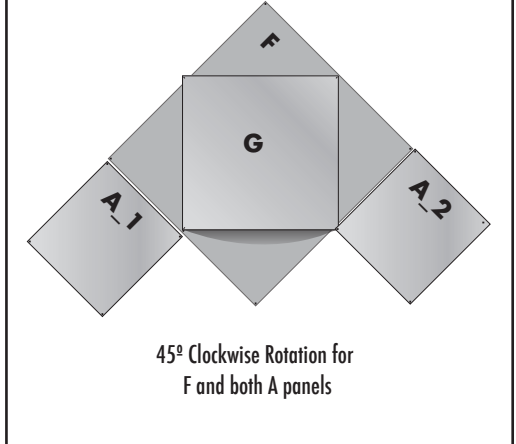

Item# 342018, 342019

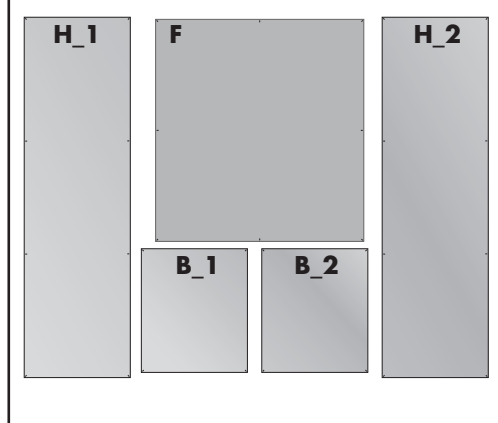

Item# 342020, 342021

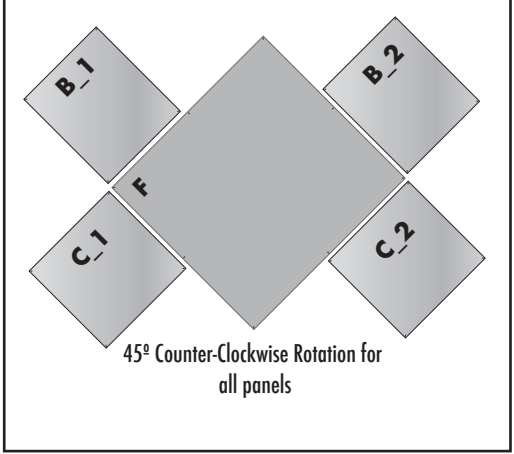

FRONT FRONT FRONT FRONT

Banner A attaches to the front of the frame on all four corners

OPTION: attach to all back corners

FRONT FRONT FRONT FRONT

Attaches to the front of the frame with the top two corners and the back of the frame on the bottom two corners.

OPTION: this can be reversed with the bottom two corners in the front and the top two corners in the back.

BACK FRONT BACK FRONT

Attaches to the front of the frame with the right two corners and the back of the frame with the left two corners.

OPTION: this can be reversed with the left two corners in the front and the right two corners in the back

FRONT FRONT FRONT FRONT

Attaches vertically to the front of the frame with all six peg holes.

OPTION: Attach to back pegs

Attaches horizontally to the front of the frame with all six peg holes.

FRONT FRONT FRONT FRONT FRONT FRONT

OPTION: Attach to all back pegs.

FRONT FRONT FRONT FRONT FRONT FRONT

Covers 4 quads and attaches to the front of the frame with all nine peg holes.

OPTION: with all nine peg holes in the back.

FRONT FRONT FRONT FRONT

Attaches diagonally to the front of the frame with all four peg holes.

OPTION: Attach to all back pegs.

The two sets of end peg holes attach to the front of the frame, the center (top and bottom) four peg holes attach to the back of the frame.

FRONT FRONT FRONT FRONT FRONT FRONT

OPTION: this can be reversed with the two sets of end peg holes attach to the back of the frame, the center (top and bottom) four peg holes attach to the front of the frame.

BOTH OPTIONS CAN BE USED VERTICAL

FRONT FRONT FRONT FRONT

Attaches vertically only to the frame, with the top four peg holes on the front of the frame, and with the bottom two peg holes attached to the back of the frame.

OTHER OPTIONS: