

DLB-1010-C

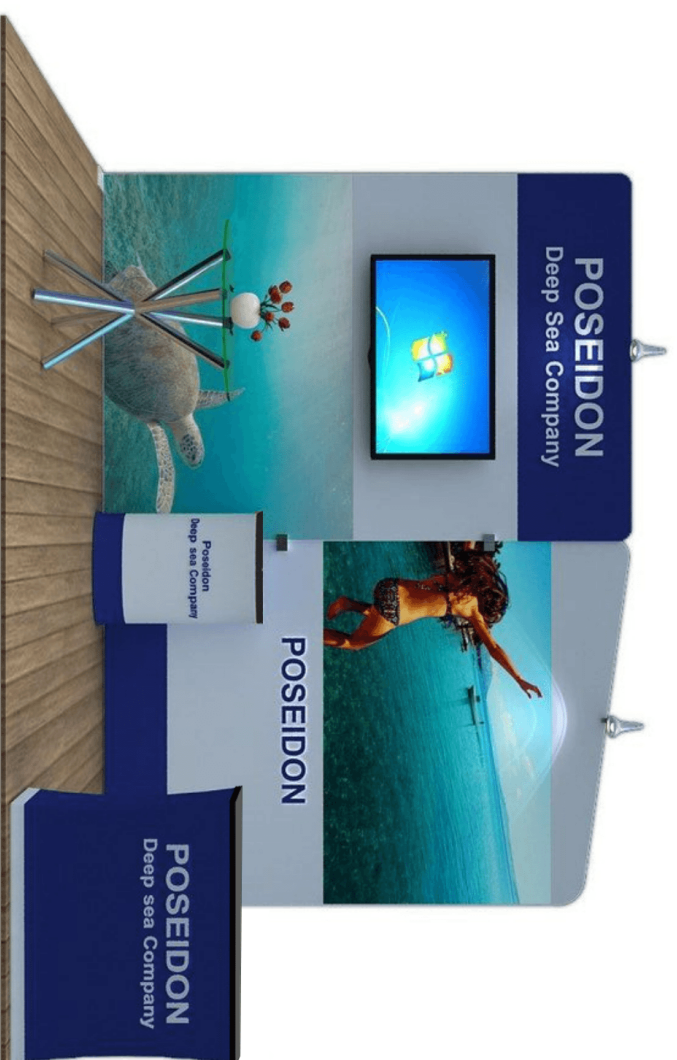

Setup Instructions

1. Take all the parts out of the bags and lay them on the ground according to the assembly diagram.
2. Make sure that all the corresponding numbers are correct.
3. Now start pushing the pipes together until they firmly click, if difficult you can slightly twist the parts together to make the locking spring pop up on place.
4. Its time to get your hands cleaned as now you are ready to handle the printed fabric. Feed the fabric from the round edges of the frame, feed only a few feet, then stand the frame up then slide the fabric to the bottom, now close the Zipper.
5. You can set up the feet in the position that you want to erect the stand, lift the fabric panels and fit on the feet.
6. To lock the frames together you can use the "S" shaped brackets, they are designed tight so they lock well.
7. If you have a header in the kit you can fix to the top by using the clear plastic clips.

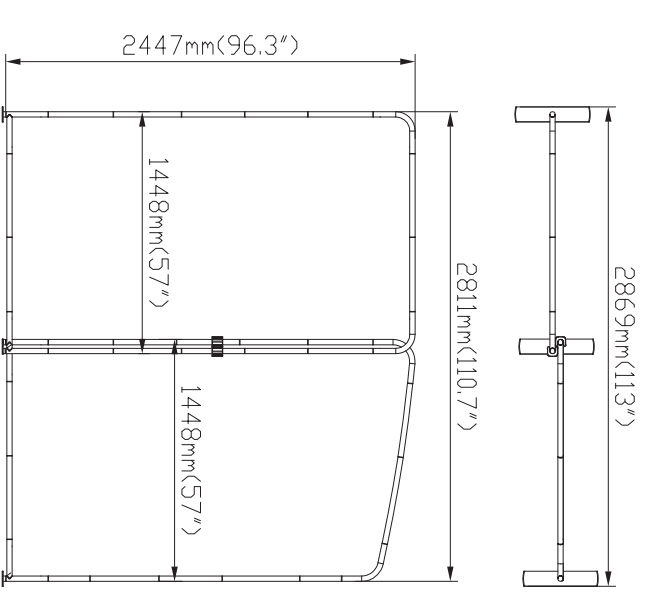
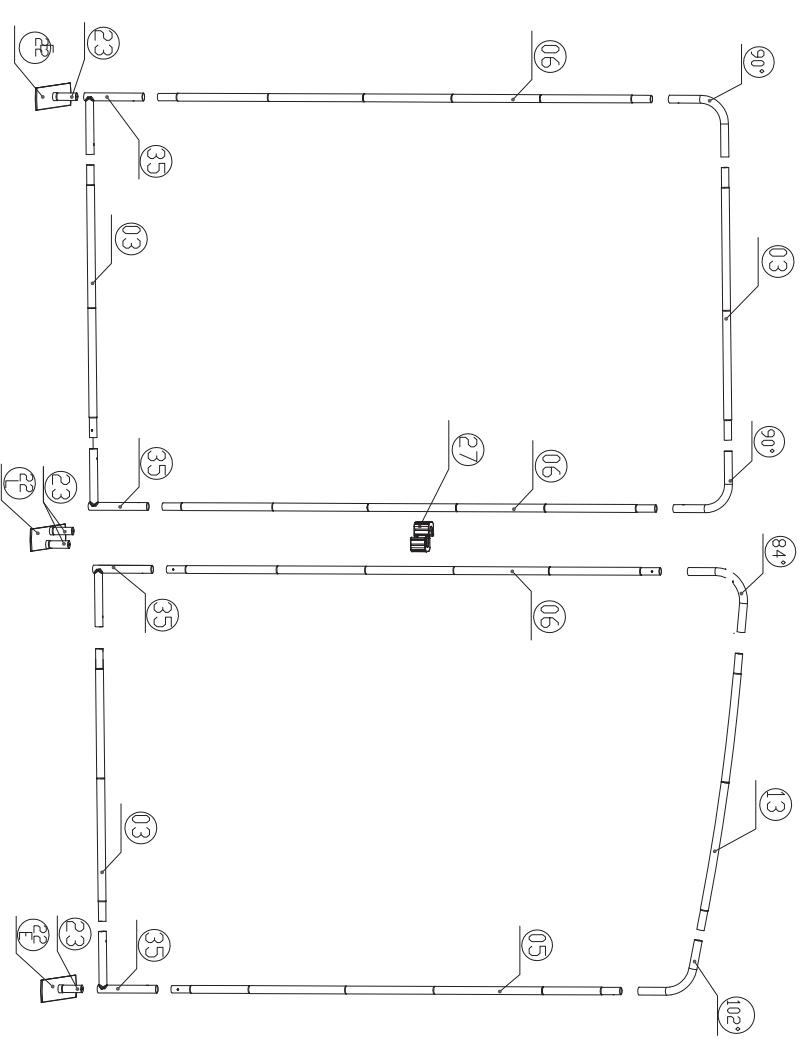



Large Monitor Mount Setup WLM-Mount-L



Description

Designed to fit any Waveline Display, these mounts achieve a "floating" screen experience. Simply slide the mount behind the display, and attach your screen on the front. Graphics can include a cut-out for easy access, or you can do your own cut as needed. Kit includes wooden base plate, aluminum post and mount.

Dimensions

Product Weight: 21lbs

Shipping Weight: 24lbs

Assembled Size: 27.5"w x 73"h x 13.7"d

Box Dimensions: 39" x 15" x 5"







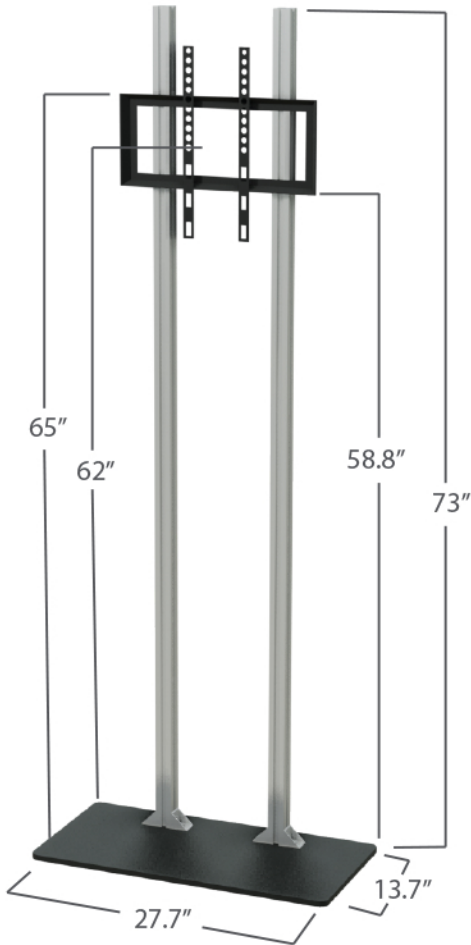

Monitor Specifications

Holds Monitors up to 55" or 50 lbs

Up to VESA 400x400



Parts

- A - x10 M8 Allen Screw 
- B - x8 Flat Gasket 
- C - x4 M8 Nut 
- D - x4 M8 Philips screw & Gasket 
- E - x2 M5 Philips Screw 
- F - x4 Bracket-to-Monitor Screws: M5, M6, & M8 screws included. Check your TV for specs 
- G - x4 L-Bracket & Cap 
- Allen Keys 
- Philips Screwdriver 



Monitor Brackets x2



Monitor Plate



Vertical Poles x4



Base



Carry Bag

*Note: Please check all pockets in the carry bag for parts.

Large Monitor Mount Setup

WLM-Mount-L

Lay poles on the floor and match the stickers together. You should see two perforations in the front of each of the top sections.

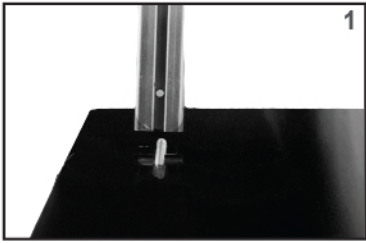
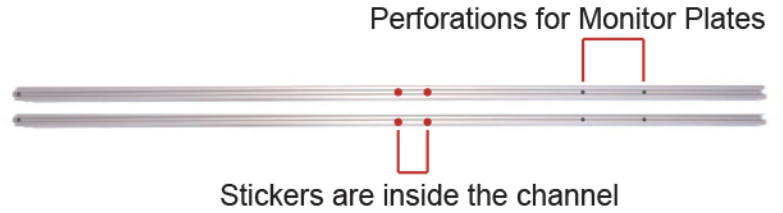

Secure each of the lower sections of the poles to the base with screw A.

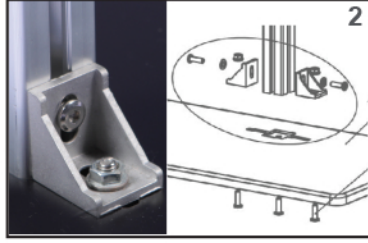

Attach the triangular supports to sides of poles, using **A** screws, **B** gasket and **C** nuts.

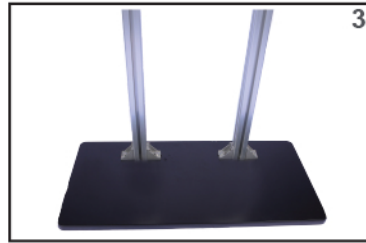

Secure screws with Allen wrench

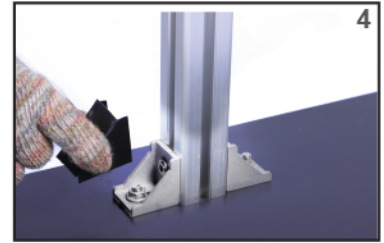

Attach caps to triangular supports

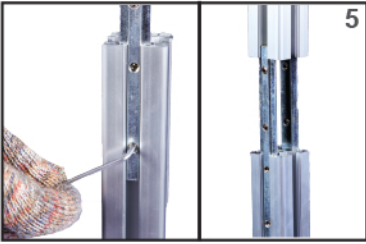

Connect the pole extension using allen key to secure connector insert



Attach the Mount Plate to the pole, use (4) Philips **D** screw



Place the Monitor Stand behind your display, slide the base forward

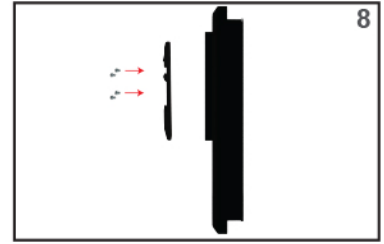

Mount the brackets to the back of the monitor with 4 **F** screws

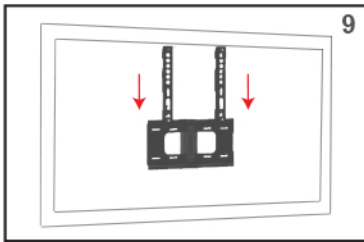

Slowly hang the Bracket onto the Monitor Plate through the opening on the graphic

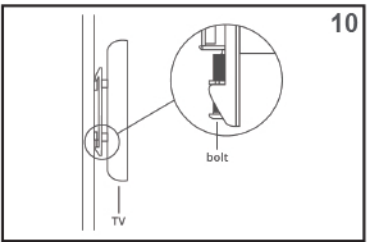

Secure the bracket to the Monitor Plate by tightening the safety screws **E**



Enjoy your display!

Case to Counter Setup Instructions



1. Hardcase with wheels and handle



2. Release fasteners



3. Get all parts out



4. Screw the poles into the case



5. Secure all 4 poles



6. Cover the black skirt or graphic on the bottom



7. Connect the top and poles



8. Place top on poles



9. Pull the black skirt or graphic up



10. Place countertop on display

***** Please Note: Fastening the poles into the base incorrectly may result in damage to the unit**

Counter Setup Instructions



1. Remove the counter from the molded bag.



2. Extend and lock the support poles



3. Place the 3 poles with the holes facing up.



4. Place counter top onto poles. Tap down with hand to secure.



5. Slide fabric graphic wrap onto hardware. Align seam to center of back of counter.



6. Angle and tuck gasket into channel in edge of counter top. Insert graphic gasket all the way around.



7. Turn counter upside-down.



8. Pull graphic taut and angle and tuck gasket into channel in edge of foot. Insert graphic gasket all the way around.



9. Turn counter back up

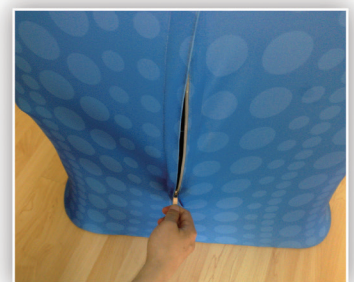

10. The zipper on the back is used to access in side the unit.