

NuWave Precision Pressure Cooker



Contents

Important safeguards	1
Safety systems and structure	3
Introduction and benefits	4
Operating instructions	4
Cleaning and maintenance	9
Troubleshooting	11
Cooking Guide	12

- ◇ Please read all instructions before use.
- ◇ Save instruction manual.

Production Information:

Item No.	31201
Body Diameter	22cm
Nominal Capacity	7.6 Liter
Working Pressure (kPa)	50~90

IMPORTANT SAFEGUARDS

When using pressure cookers, basic safety precautions should always be followed:

- Read all instructions carefully before using your pressure cooker. Do not permit anyone who is not familiar with these instructions to use the cooker.
- Keep children away from the pressure cooker when it is in operation. Close supervision is necessary when the pressure cooker is used.
- Never place the pressure cooker into the oven or microwave.
- Move the pressure cooker carefully when in operation. Do not touch hot surface, as this could result in burns. When the pressure cooker is heated, only touch lift with handles and always use protective gloves. Extreme caution must be used when moving a pressure cooker containing hot liquids.
- Do not use pressure cooker for other than intended use. Only use the pressure cooker for the purposes described in these instructions.
- Do not use pressure cooker for frying oil.
- This appliance cooks under pressure. Improper use can lead to burns and scalding. Make sure the pressure cooker is properly closed before operating. See “**Operating instructions**”.
- Your NuWave Precision Pressure Cooker is only suitable for use with the following heating sources: gas, electric, ceramic, induction. Do not attempt to use other sources.



Gas



Electric



Ceramic

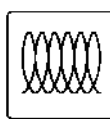

Induction

- Before using the pressure cooker, check it to make sure the safety mechanisms are not damaged or dirty and valves are not obstructed. Always check the pressure release device for clogging before use. See “**operating instructions**”.
- Do not open the pressure cooker until it has cooled and all internal pressure has been released. If the handles are difficult to push apart, this indicates that the cooker is still pressurized – do not force it open. Any pressure in the cooker can be hazardous. For releasing the pressure, please see “**Operating Instructions**”.
- Never using the pressure cooker without liquid, as this could result in damage.

Adhere strictly to the following content amounts:

Minimum: 0.26 Qt (1/4 Liter) of liquid

Maximum: 2/3 of the pressure cooker

For foods which foam or rise (e.g. rice, legumes, broths, or dried vegetable), do not fill the cooker more than half full. Over filling may risk clogging the vent pipe and the development of excess pressure.

- Be aware that certain foods, such as applesauce, cranberries, pearl barley, oatmeal or other cereals, split peas, noodles, macaroni, rhubarb, or spaghetti can foam, froth, and sputter, and may also clog the pressure release device (vent pipe). These foods should not be cooked in NuWave Precision Pressure Cooker.

-
- When cooking doughy food, gently shake the cooker before opening the lid to avoid food ejection.
 - If you cook meat with skin or sausage with casing, which can swell when under pressure, do not pierce the skin as long as it is swollen. This could result in scalding.
 - When the normal operating pressure is reached, turn the heat down so all the liquid, which creates the steam, does not evaporate.
 - Pressure cooker cannot be used for medical purposes, especially for sterilization, as the pressure cooker is not designed to reach the required temperature.
 - Do not alter the safety mechanisms or repair the pressure cooker by yourself. Please contact the store where it was purchased for details.
 - Use only the appropriate NuWave Precision Pressure Cooker replacement parts, to ensure your pressure cooker will function properly and safety.
 - Do not tamper with any of the safety systems beyond the maintenance instructions specified in the instructions for use.

- **SAVE THESE INSTRUCTIONS.**

SAFETY SYSTEMS AND STRUCTURE

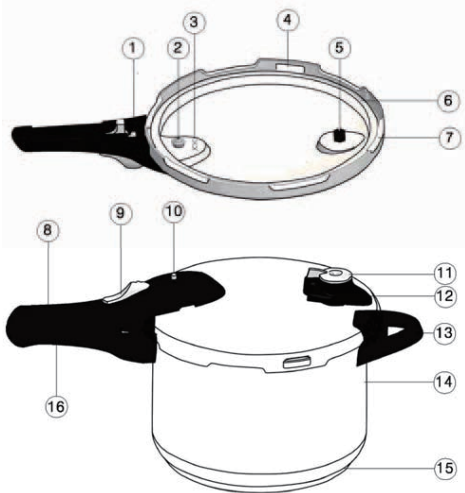

1, **Safety Plate:** This is activated with the locking valve to avoid opening the lid when there is pressure in the cooker.

2, **Safety Valve:** A safety device opens and closes automatically to avoid excess pressure within the cooker.

2a, Safety valve

2b, O-Ring for safety valve

3, **Batch Number.**

4, **Safety Window:** A safety device to release excess pressure by pushing the rubber gasket out when the cooking pressure is too high.

5, **Anti-Clogging Nut:** It effectively prevents food from plugging the steam outlet to avoid excess pressure within the pressure cooker.

6, **Rubber Gasket:** It must be completely clean.

7, **Lid:** Made of quality stainless steel.

8, **Lid Long Handle:** Used to remove the lid from the cooker, the lid handle contains important components vital to the use of pressure cooker.

9, **Push Plate:** When the lid is properly closed, push the push plate backwards to lock. Push the push plate forwards to unlock the lid.

10, **Pressure Indicator:** Pressure indicator moves up in a few minutes after heated and it returns to original place when pressure completely released.

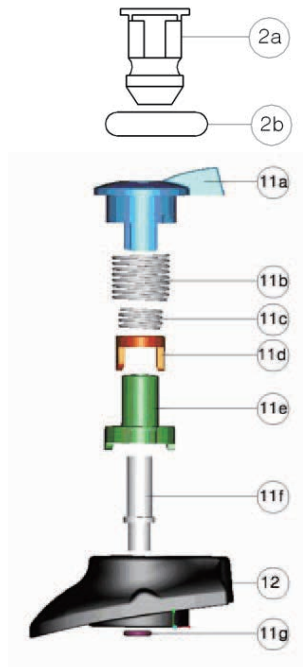

11, **Pressure Regulator:** Pressure setting device: “1”=low pressure level, “2”=high pressure level. This keeps the pressure within the normal operating level and keeps the pressure stable while cooking.

11a. Valve shaft

11b. Large spring

11c. Small spring

11d. Valve shaft cover

11e. Valve shaft core

11f. Ventilated pipe: the device for the releasing of steam in the cooker.

11g. Sealing ring for pressure regulator

12, **Pressure Regulator Base:** Part of pressure control device.

13, **Side Handle:** This functions as a helping handle when moving the cooker.

14, **Pressure Cooker Pot.**

15, **Body Base:** It's made up of three layers of material, with quick and even heat conduction and can be used on induction.

16, **Body Long Handle:** “△” marks the right position where lid and pot fits together.

INTRODUCTION AND BENEFITS

The structure of a pressure cooker consists of a regular cooking pot and a special lid that locks in place on the top of the cook pot. When the cooker is heated, steam is sealed inside and creates pressure. With this high pressure, the internal temperature of the cooker is raised above the normal boiling point of water, which leads to a faster and healthier cooking process.

1 Faster

- On average, the NuWave Precision Pressure Cooker prepares food up to 3 times faster than conventional cooking methods. Meals that can take up to one hour with conventional cooking can be ready in as little as 20 minutes with a NuWave Precision Pressure Cooker.

2 Tastier

- Food tastes better when prepared with a NuWave Precision Pressure Cooker. The shorter cooking time allows food to retain its full and natural flavor. Less seasoning is required, up to half of what you would normally use, and very little flavor is actually lost during the cooking process.
- Unlike microwave cooking, meat prepared in a NuWave Precision Pressure Cooker is golden brown. Simply sauté, then cook under pressure.

3 Healthier

- More Vitamins and minerals are retained in food prepared with a NuWave Precision Pressure Cooker. The NuWave Precision Pressure Cooker can help food retain more than twice their vitamins and nutrients compared to conventional stovetop cooking, by using less water.

4 Multi-Functional

- The NuWave Precision Pressure Cooker can be used for steaming, simmering, stewing, roasting and even defrosting. Cooking time is saved when preparing everything from delicate soups and desserts to hearty meat dishes.

OPERATING INSTRUCTIONS

1 Before first use

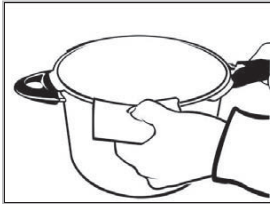

Figure 1

- Take time to **read all the instructions**
- Take all accessories out of the cooker pot.
- Season the cooker rim with a little cooking oil, in order to make opening and closing easier. See Figure 1.
- Fill the pressure cooker 1/2 full with cold water, and heat the pressure cooker for 10 minutes according to the operating instructions labeled **“checking before closing”, “the fitting of lid and pot” and “cooking”**.
- Open the pressure cooker after it is completely cold and all pressure has been released. Empty the pressure cooker and make it dry with soft cloth.

2 Safe Operation

Getting Started

(1) Adding food and liquid

- To cook with the commercial pressure cooker, it is important to fill with liquid that is capable of steam releasing after boiled. Water, soup, stock or wine is acceptable in this case.
Maximum Volume: **NEVER** fill the pressure cooker more than 2/3 of the cooker's capacity with liquid and food. See Figure 2.
- Fill only halfway of the cooker's capacity when cooking foods that will either expand in size and/or produce foam as they cook (such as rice, legumes, broths, or dried vegetable). See Figure 2.
Minimum Volume: The cooker must always contain at least 0.26Qt (1/4 liter, 2 cups) of liquid for cooking. See Figure 2.

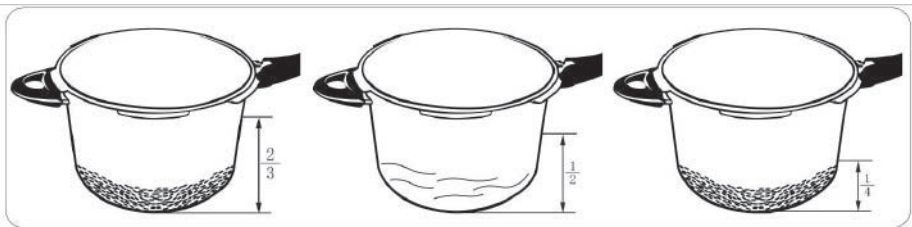

Figure 2

- Always add enough liquid for steam to form and make sure that the liquid in the pressure cooker does not evaporate completely.
- Never allow the cooker to 'cook until dry', as the resulting overheating could damage the cooker (e.g. melt the base, or damage the safety mechanisms) and the heat source.
- In case of overheating, never remove the cooker from the heat source. Simply turn off heat source and let the cooker cool down completely.

(2) Checking before closing

- Check and make sure the **O-ring** is on the groove. Do not use the cooker if the **O-ring** is not in the correct positions. See Figure 3.

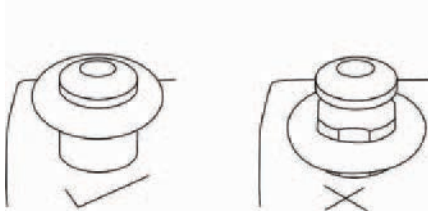

Figure 3

- Check to make sure that the indicator rod can move freely, by pushing it upwards. If it springs back easily, it will function properly.
- Remove the **pressure regulator**, make sure that the steam outlet is not blocked. You should be able to look through the steam outlet if it is clear. Clean the anti-clogging nut and safety valve with warm water. See Figure 4.

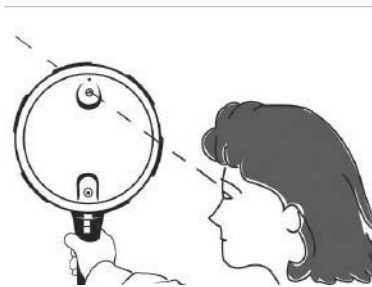

Figure 4

- Ensure that the O-ring for the **safety valve** is clean and not damaged.
- Check to see that the rubber gasket is correctly in place in the lid.

Fitting of Lid and Pot

- (1) Place the lid on the cooker body. Align the “O” mark on the lid with the “△” mark on the body handle. See Figure 5.
- (2) Press down slightly on the lid and turn clockwise just until the two handles match up and lock together. To ensure that the lid is properly closed, the lid handle and the body handle should align with each other. See Figure 6.
- (3) After locking the cooker, slide the pressure lock button down against the lid until the locking is heard. See Figure

7.

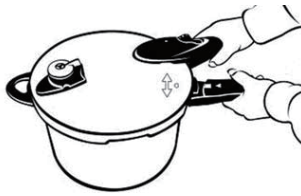

Figure 5

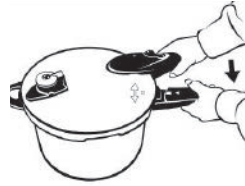

Figure 6

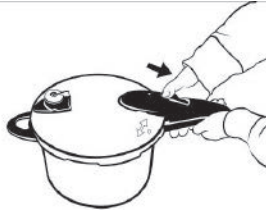

Figure 7

Cooking

(1) Moving and Positioning the NuWave Precision Pressure Cooker

Place NuWave Precision Pressure Cooker on a heat source with a diameter of at least to 18cm/7inches. When using a gas stove, make sure that the flame does not go beyond the edge of the pot base.

(2) Pressure setting

There are 4 positions for selector to set. You may use position 2 in normal cases and special position 1 for quick cooking of easily cooked food. See Figure 8 & 9

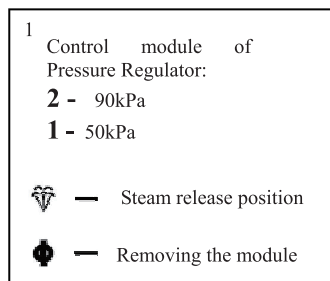

Figure 8



Figure 9

(3) Cooking

- Begin with the heat source at high. See figure 10.
- A small amount of steam may escape from the steam outlet.
- When cooking begins, the temperature rises and the pressure cooking process begins automatically.
- The **pressure indictor (red)** rises, which indicates the internal pressure is building up. See figure 11



Figure 10

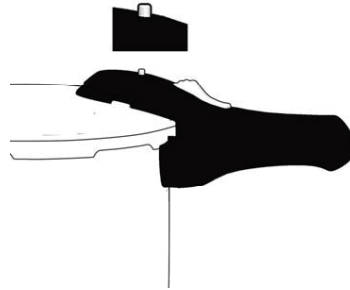

Figure 11

- When steam escapes steadily from the pressure regulator, reduce the heat and set your cooking time as indicated by your recipe or according to your own preferences. See figure 12.

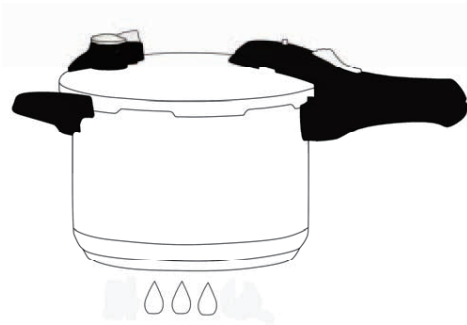

Figure 12

- Precautions must be taken to control the heat setting so that flames do not reach the wall of the cooker.
- When locking valve rises quickly, it's normal to have a small amount of steam escaping from the side of the handle.

Opening

(1) Cooling after cooking

- Turn off the heat source and let the pressure cooker cool down naturally.
- Do not cool the cooker with running water (Figure 13).

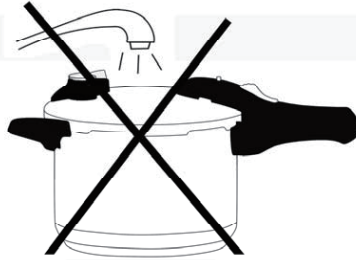

Figure 13

(2) When pressure indicator is down in the normal position, gently shake the cooker and turn the valve to the steam release position to release any remaining steam. After all steam is released, the lid can be opened.

- Push the **push plate** towards cover center. See Figure 14.
- Turn the lid handle counter-lockwise. See Figure 15.
- Match “O” on the lid and “△” on the body handle, then lift the lid handle to open. See Figure 16.

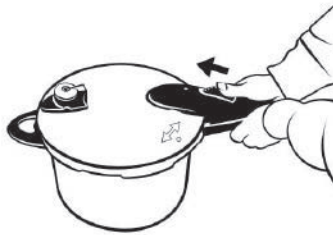

Figure 14

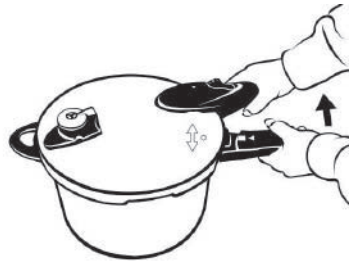

Figure 15



Figure 16

CLEANING AND MAINTENANCE

- Do not store food in pressure cooker when not in use.
- Clean and dry the cooker after each use. Warm water is recommended for cleaning.
- Do not wash the lid in a dishwasher.
- Before each use, ensure the cover of the **pressure indicator or safety valve** is not damaged and it fits well. If there is damage, replace the cover before using the cooker again.
- After each use, release and clean the **anti-clogging nut** and the **pressure regulator** completely. The steam discharging tube and the **anti-clogging nut** should not be filled or blocked by any substances, such as food residue.

When installing the **pressure regulator**, make sure that it is installed in the correct position.

- After each use, the safety valve should be examined to ensure it is clean. Clean with hot water if required.
- After each use, the rubber gasket should be cleaned thoroughly with warm water. It should be installed back in the lid after washing.
- Do not use steel wool, abrasive scouring powders or liquids.
- The rubber gasket will last longer if you place the lid upside down on top of the pressure cooker body after it has been washed.
- Depending on how often the pressure cooker is used, you should replace the **rubber gasket, the O-ring for the safety valve and sealing ring for pressure regulator** every 1-2 years. In case of damage (tears or cracks, deformation on the edges or hardening), these parts should be replaced immediately. Failure to do so may affect proper functioning and safety. For details on replacement parts for your pressure cooker please contact Hearthware's Customer Service at 1.888.689.2831.

Simple cleaning

To extend pressure cooker's life span, promptly remove excess foods after each use. Wash, clean and dry the pressure cooker making sure all the food residue is removed especially acid or alkali foods. The pressure cooker pot and lid should be washed with warm water and a mild detergent and a non-abrasive cleaning pad.

Special cautions must be taken to preserve the spare rubber parts in the lid.

Thorough cleaning

(1) Cleaning of pressure regulator

Remove the pressure regulator by pressing and rotating it after each use (See Figure 17). Turn counter-clockwise to remove. (Figure 18). Clean with warm water (Figure 19).



Figure 17



Figure 18

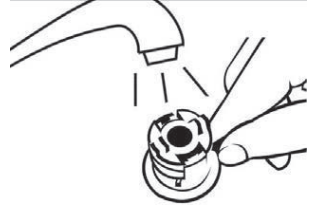

Figure 19

(2) Cleaning of anti-clogging nut and steam outlet

Make sure the anti-clogging nut and steam outlet are rinsed with running water after each use.

(3) Cleaning of Safety valve

Clean the safety valve by repeatedly pushing it up and down whilst running under water. See Figure 20.

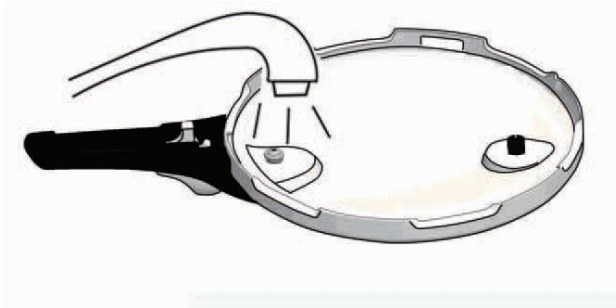

Figure 20

TROUBLE SHOOTING

Symptom	Cause	Solution
Steam escapes around the pressure regulator	This is normal. However, if a very large amount of steam escapes, you should reduce the temperature	Turn down the heat and then continue cooking as usual. Decrease liquid as instruction
No steam escapes from the pressure regulator	There is not enough liquid in the cooker	Add at least the minimum amount (0.25 liter) of liquid
A lot of steam leaks from the pressure indicator valve	The O-ring for the pressure indicator is not properly installed	Install the O-ring properly in the groove
Steam escapes at the edge of the lid	The rubber gasket is not properly in place The rubber gasket is dirty or damaged	Insert the gasket properly Clean and replace the gasket
The indicator rod does not rise	The heating temperature is too low The cooker is not closed properly There is not enough liquid in the cooker The rubber gasket is damaged or hardened The pressure regulator is not attached correctly and firmly The O-ring for the safety valve is missing, damaged or fitted incorrectly	Increase heat Close the cooker properly by making sure the push plate is in the locking position Add at least the minimum amount (0.26 Qt /0.25 Litre) of liquid Replace the gasket Insert the pressure regulator correctly and select a pressure setting by following step 2. Attach a new O-ring correctly on the valve base
The indicator rod does not move down	Pressure remains in the cooker	Wait until the pressure releases from the cooker and turn the pressure control device to <u>steam releasing setting</u>
Opening and closing system does not work	Marked 'O' on lid does not align with "△" on long handle	Make them align by making sure the push plate is in the locking position

Note: If you are unable to solve a problem or correct a defect, please contact Hearthware's Customer Service department for further assistance at (888) 689-2831.

Use only recommended spare parts for the NuWave Precision Pressure Cooker

Cooking Guide

The cooking times shown here are for guidelines only.

FOODS	Cook Time (Mins)	Level
Chicken	20-25	2
Beef Stroganoff	6-7	2
Ham, boiled	28-32	2
Pork roast	25-30	2
Turkey leg	25-30	2
Veal roast	15-20	2
Pork ribs	8-10	2
Fish	4-5	2
Cabbage stew	13-15	1
Irish stew	15-18	2
Mushrooms	6-8	1
Potato soup	4-5	1
Chicken soup	20-30	2
Tomato soup with rice	5-8	2
Vegetable soup	5-8	1
Cauliflower	3	1
Mixed vegetables	5-6	1
Raw brown rice, oats, wheat	8-9	2
Potatoes in jackets	7-10	2
Boiled potatoes (quartered)	4	2
Sliced potatoes	2	2

WARRANTY

The NuWave Precision Pressure Cooker has a 2 year warranty against material & manufacturing defects. The warranty only covers the body, it does not cover parts of the pressure cooker which are subject to wear (eg - rubber gasket and O-ring for Safety Valve).

Improper use will result in cancellation of the warranty. The warranty will only be considered valid if the product is used in accordance with Use & Care Instructions and upon presentation of a dated proof of purchase.

*Nu*PRECISION
WaveTM
INDUCTION COOKTOP

Hearthware[®]

Distributed by Hearthware, Inc.

1755 N. Butterfield Road, Libertyville, IL 60048, U.S.A.

Customer Service

1.888.689.2831 or picsupport@hearthware.com

Business Hours

Monday- Friday 8:00am - 4:30pm (CST)

www.NuWaveNow.com • www.NuWavePIC.com

© 2012 Hearthware, Inc. All Rights Reserved. Made in China.