

nuwave[®]
— LIVE WELL FOR LESS —

**RECIPES
INCLUDED!**

NuWave Brio[®] 3Q Digital Air Fryer



Owner's Manual & Complete Recipe Book

nuwave®

LIVE WELL FOR LESS



NuWave Brio® 6Qt Digital Air Fryer

Super-heated air cooks your food to crispy, tender perfection. The digital touch screen gives you precise temperature control.

NuWave Nutri-Pot® 6Q Digital Pressure Cooker

Easily cook rice, poultry, vegetables and more all with the press of a button! The Nutri-Pot's safety release valve and hinged lid make for convenient and safe operation.

For more about our innovative products, visit:



NuWave Primo™ Combo Grill

With the NuWave Primo™ Combo Grill, there's no need to worry about hot spots or dried-out leftovers. The intuitive controls of this countertop smart oven make it incredibly easy to cook like a professional chef. Everything from large family meals to frozen foods cook with ease, without preheating or defrosting.

NuWave PIC® (Precision Induction Cooktop)

Cook faster, safer, and more efficiently than you ever could on your gas or electric stovetop.

www.nuwavenow.com

 1-877-689-2838

nuwave®

LIVE WELL FOR LESS



NuWave BruHub® Coffee Maker

Quality and convenience at your fingertips. The NuWave BruHub accommodates virtually all of your favorite single-serve pods, but with more flavor. Makes an 8- or 12-ounce cup and full carafe. The thermal stainless steel carafe keeps coffee hot for hours.

NuWave Moxie® High-Performance Vacuum Blender

With the simple press of a button, the NuWave Moxie can remove all the excess air from the blender. By vacuuming the air out of the blender, you can ensure no air is being mixed with your ingredients during the blending process, maximizing the nutritional value and ensuring your blender creations will remain fresher longer.

For more about our innovative products, visit:



NuWave Duralon® Healthy Ceramic Non-Stick Cookware

Coated with Duralon Healthy Ceramic Non-Stick coating for easy cleanup, this versatile cookware is perfect for use in ovens or on gas, electric, and even induction cooktops.

NuWave Bravo™ XL





The NuWave Bravo™ XL Smart Oven is an air fryer, toaster, and convection oven all in one! The Bravo features an extra-large, 1-cubic-foot capacity. Includes 12 convenient, one-touch pre-programmed presets. Set precise temperatures from 100°F to 450°F.

www.nuwavenow.com

 1-877-689-2838

GUIDE

The following guide indicates the amount of time, temperature, and weight for the various food types that are listed below.

Food Type	Shake/ Flip	Time (min)	Temp (°F)	Suggested Amount	Additional Notes
Frozen French Toast Sticks	Flip	8-10	380	8 oz	/
Frozen Hash Brown Patties	Flip	18-25	360	1-3 patties	/
Cinnamon Rolls	/	10-12	350	1-4 rolls	Cover w/foil ½ way
Thin Frozen Fries	Shake	8-14	400	16 oz	/
 Frozen Fries	Shake	14-17	400	16 oz	Medium cut
 Homemade Fries	Shake	20-25	360	12 oz	Soak in water - 30 minutes
Homemade Potato Wedges	Shake	20-25	360	12 oz	Soak in water - 30 minutes
Homemade Potato Cubes	Shake	15-20	360	12 oz	Soak in water - 30 minutes
 Steak (½" ribeye)	Flip	12-18	360	1-2 (8 oz each)	/
Pork Chops (with bone)	Flip	15-20	375	1-2 (8 oz each)	/
Frozen Hamburgers	Flip	16-20	360	1-2 (5 oz each)	/
Fresh Hamburgers	Flip	12-16	360	1-3 (8 oz each)	/
Italian Sausage	Flip	13-15	400	1-4 (4 oz each)	/
Chicken Wings	Shake	20-25	390	12 oz	/
 Poultry	Flip	11-14	360	1-2 (8 oz each)	Chicken Breast
Frozen Tater Tots	Shake	6-8	360	12 oz	/
Spring Rolls	Shake	6-8	360	12 oz	/
 Chicken Nuggets	Shake	8-12	400	8 oz	/
 Fish	Shake	6-10	400	8 oz	Frozen Fish Sticks
Stuffed Poppers	Shake	8-10	360	8 oz	/
Onion Rings	Shake	12-16	360	12 oz	/
Breaded Mushrooms	Shake	8-10	390	8 oz	/
Mozz. Sticks/Zucchini	Shake	5-7	360	12 oz	/

Note: Actual cooking times may vary depending on the size and shape of the ingredients used. Listed cooking times should be used as a guide. Adjust the settings as necessary to suit your needs. According to the FDA, the safe internal temperature is 165°F for poultry and 160°F for pork.

TABLE OF CONTENTS

Guide	6	Roasted Cornish Game Hen w/Honey	
Important Safeguards	8-9	Mustard Glaze	33
Additional Safeguards	10	Cajun Shrimp	34
Parts Description	11	Chimichurri Skirt Steak	35
Operating Instructions	12-15	Grilled Ham and Cheese	36
Care & Maintenance	16	Tortilla Crusted Tilapia	37
Care & Use For Accessories	17	Tuna Sliders	38
Troubleshooting Guide	18-19	Turkey Sliders	39
Warranty	20	Pork Loin Sandwiches	40
Recipes		Citrus Green Beans	41
Baked Potato	22	Crispy Tofu	42
Roasted Brussel Sprouts	23	Air Fryer Curry Calamari	43
Home Fries	24	Party Meatballs	44
Air Baked Eggs	25	Kale Chips	45
Air Fried Tortilla Chips	26	Roasted Tomatoes	46
Sliders	27	Roasted Root Vegetables	47
Buffalo Wings	28	Apple Pie Egg Rolls	48
Chicken Kiev	29	Banana and Nutella Wontons	49
Chicken Satay	30	Pineapple Crescents	50
Grilled Chicken Tenders	31	Crescents Rolls	51
Parmesan Chicken Tenders	32	Spanish Manual	52-67



IMPORTANT SAFEGUARDS

READ ALL INSTRUCTIONS

When using electrical units, basic safety precautions should always be followed including the following:

1. Do not touch hot surfaces Use handles or knobs.
2. To protect against electrical shock, do not immerse cord, plugs, or the Brio in water or other liquids.
3. Do not operate any appliance with a damaged cord or plug or after the appliance malfunctions or has been damaged in any manner. Return appliance to the nearest authorized service facility for examination, repair, or adjustment.
4. If the power cord is damaged, do not attempt to operate the Brio.
5. Close supervision is necessary when any appliance is used near children. This appliance is not intended for use by persons (including children) with reduced physical, sensory or mental capabilities, or lack of experience and knowledge, unless they have been given supervision or instruction concerning use of the appliance by a person responsible for their safety.
6. The use of other accessories that are not intended to be used with the Brio is not recommended. Doing so may damage the Brio and can cause accidents.
7. NOT INTENDED FOR OUTDOOR USE. INTENDED FOR HOUSEHOLD USE ONLY.
8. Do not use appliance for other than intended use.
9. Do not let cord hang over edge of table or counter or touch hot surfaces.
10. Do not place on or near a hot gas, electric burner, and/or in a heated oven.
11. Extreme caution must be used when moving the Brio containing hot oil or other hot liquids.
12. To disconnect, turn the Brio "OFF", then remove plug from the wall outlet.
13. During air-frying, hot steam is released from the air outlet vent. Keep hands and face at a distance from the steam and from the air outlet vent. Also, be careful of hot steam and air when removing Fry Pan Basket.
14. Make sure the ingredients prepared in the Brio come out golden brown instead of dark brown and not burnt. Remove any burnt remnants from Fry Pan Basket during cleaning and before each use.
15. Never put the Brio against the wall or other appliances. There should be at least 3 inches of free space for the back side, left/right sides, and the upper side of the Brio. Do not place anything on top of the Brio.
16. Unplug the Brio from outlet when not in use and before cleaning. Allow the Brio to cool before cleaning, putting on or taking off parts.
17. The Brio is not intended to be operated by means of an external timer or separate remote-control system.
18. Keep manual handy for future reference.

IMPORTANT SAFEGUARDS (Continued)

SEE OPERATING INSTRUCTIONS BEFORE USE

Electrical Information

A short power-supply cord (or detachable power-supply cord) is provided to reduce the risk resulting from becoming entangled in or tripping over a longer cord. Longer detachable power-supply cords or extension cords are available and may be used if care is exercised in their use. If a longer detachable power-supply cord or extension cord is used:

1. The marked electrical rating of the extension cord should be at least as great as the electrical rating of the appliance.
2. The longer cord should be arranged so that it will not drape over the countertop or tabletop where it could be pulled on or tripped over unintentionally. The Brio should be operated on a separate electrical outlet from other operating appliances due to wattage limitations. The appliance has a polarized plug (one blade is wider than the other). To reduce the risk of electric shock, this plug is intended to fit into a polarized outlet only one way. If the plug does not fit fully into the outlet, reverse the plug. If it still does not fit, contact a qualified electrician. Do not attempt to modify the plug in any way.
3. If the appliance is of the grounded type, the cord set or extension cord should be a grounding-type 3-wire cord.

SAVE THESE INSTRUCTIONS

Read and understand the entire manual before using the Brio.

DO NOT USE THE UNIT FOR OTHER THAN INTENDED USE.

Note: Put the Brio on a surface that is horizontal, even, and stable.

This appliance is intended for normal household use. It is not intended to be used in environments such as a kitchen staff of shops, offices, farms, or other work environments. Nor is it intended to be used by clients in hotels, motels, bed and breakfasts, and non-residential environments.

NOTICE: THE FAILURE TO FOLLOW ANY OF THE IMPORTANT SAFEGUARDS, ADDITIONAL SAFEGUARDS, OR THE INSTRUCTIONS FOR SAFE USE IS A MISUSE OF YOUR BRIO THAT CAN VOID YOUR WARRANTY AND CREATE THE RISK OF SERIOUS INJURY.



WARNING

In case of other problems, immediately unplug and contact Customer Service Department.

1-877-689-2838 • help@nuwavenow.com

ADDITIONAL SAFEGUARDS

1. Do not place the Brio close to flammable materials, heating units, or wet environments.
2. Height of ingredients placed in the Fry Pan Basket should comply with the directions listed under “Operating Instructions”.
3. Do not put any other cooking pans in the Fry Pan Basket. Do not replace any parts with other containers.
4. It is normal for some smoke to escape the Brio when heating for the first time.
5. If a lot of smoke is escaping from the air vent during operation, unplug the Brio immediately and contact Customer Service.*
6. Do not move the Brio while in operation. Only after the Brio has completely cooled should moving be attempted. Always wait for the Air Fryer to cool down prior to handling it.
7. Children should be supervised to ensure that they do not play with the appliance.
8. Never use a towel or other material or object to block the air vents.
9. If any trouble arises during operation, any service MUST be done by NuWave, LLC or authorized by the manufacturer for repairs.
10. The appliance is not intended to be operated by means of an external timer or separate remote-control system.
11. Do not disassemble the Brio or replace any parts without prior written consent from the manufacturer.
12. Do not use metal utensils with the coated Fry Pan Basket or Fry Pan Basket Net as this can damage the surface.
13. Make sure the Brio is always clean prior to cooking.

*Customer Service Department: 1-877-689-2838 • help@nuwavenow.com

CAUTION



- Always put the ingredients to be fried in the Fry Pan Basket to prevent direct contact with the heating components.
- Do not cover the air inlet and outlet openings while the appliance is operating.
- Do not pour oil into the Base Tray or Fry Pan Basket, as this may create a fire hazard.
- Never touch the insides of the appliance while it is operating.

PARTS DESCRIPTION

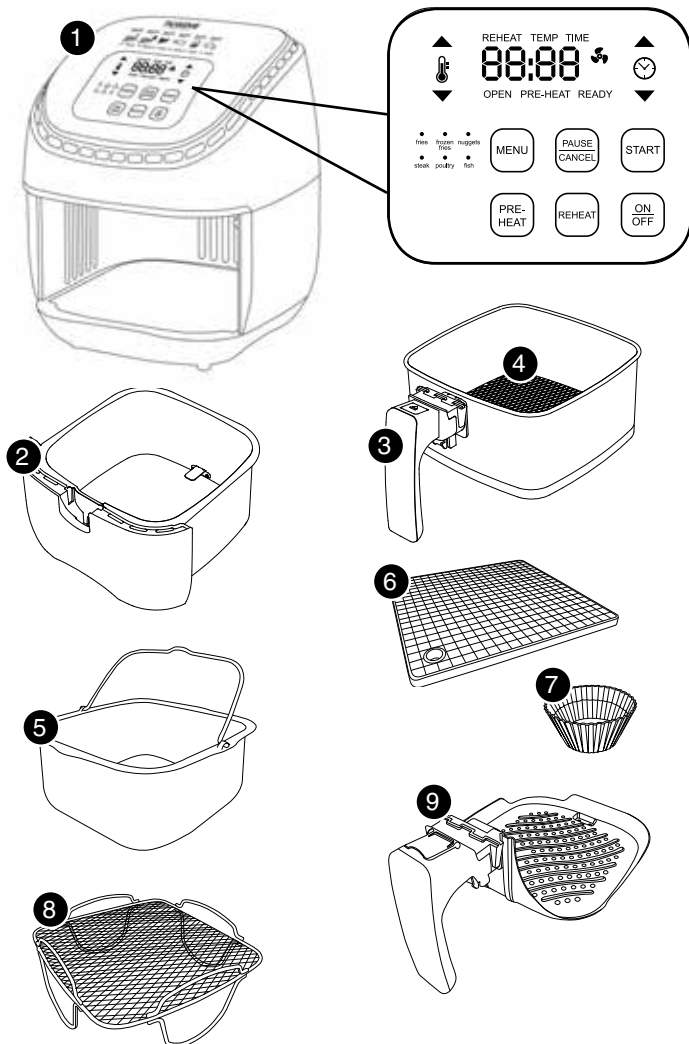

- | | | |
|--|---|---------------------------------|
| 1. Air Fryer Power Base
Part #: 36231 | 5. Baking Pan*
Part #: 36207 | 9. Grill Pan*
Part #: 36205 |
| 2. Base Tray
Part #: 36232 | 6. Silicone Mat*
Part #: 36208 | Carrying Case*
Part #: 26016 |
| 3. Fry Pan Basket
Part #: 36233 | 7. Silicone Cup Cake Liners*
Part #: 36209 (10 Pack) | |
| 4. Fry Pan Basket Net
Part #: 36204 | 8. Reversible Rack*
Part #: 36206 | |

*Optional

OPERATING INSTRUCTIONS

Before Use:

1. Remove all the packaging materials.
2. Remove the glue and labels on the appliance.
3. Clean the Fry Pan Basket, Base Tray, thoroughly with hot water, a nonabrasive sponge and a mild dish detergent, or in the dishwasher, top rack only.
4. Wipe the inside and outside of the appliance with a wet cloth. Do not immerse the appliance in water.
5. The NuWave Brio 3Q Digital Air Fryer comes with a special housing underneath for easy and convenient chord storage. You will see a portion sticking out and the rest of chord neatly wound in the housing.

Note: This appliance cooks using hot air. DO NOT fill the basket with oil.

Operation Preparation:

1. Place the appliance on a level, even, and stable heat-resistant surface.
2. Place the Base Tray and Fry Pan Basket in the NuWave Brio 3Q Digital Air Fryer
3. Plug the appliance into a standard wall socket.

Note: Do not cover or block the vent located on the back of the NuWave Brio 3Q Digital Air Fryer. Doing so can prevent proper ventilation and will adversely affect the cooking results.

Operation Functions - On/Off Function:



Press "On/Off" button once to turn the unit on. The control panel should display "0" indicating that no cooking time or temperature has been selected and the unit is powered on. Press "On/Off" button again to turn the unit off.

Start Function:



Press "Start" button once to begin cooking, ":15" will be displayed as well as a fan icon, and the NuWave Brio 3Q Digital Air Fryer will start to countdown. The default is 360°F for 15 minutes.

Pause/Clear Function:









- To interrupt the cooking or preheating process, press the "Pause/Clear" button once. "5" will be flashing on the display indicating a 5-minute countdown. If no other actions are taken during this countdown, "0" will be shown on the display. To resume after the unit has been paused, press the "Start" button once.
- To clear the programmed cooking time and temperature, press the "Pause/Clear" button a second time. This will erase the current cooking functions. "0" will be shown on the display.

OPERATING INSTRUCTIONS (Continued)

MENU

Menu Selection:

Press "Menu", the red light above fries will illuminate and "25" will be displayed. Press "Start" to begin cooking, the countdown will begin. To choose a different food from below, before you press "Start", simply press "Menu" to select the food. See chart below for pre-programmed "Menu" selections. To get out of the menu selection, press menu again until the red light above the food type is no longer lit. If using the Pre-Heat function, press "Pre-Heat" before "Menu" to ensure proper temperature. All menu selections default to 1300 watts.

Food Type	Time (minutes)	Temp	Food Amount (ounces)
 Fries (Homemade Thick cut)	25	360°F	12
 Frozen Fries (Medium cut)	15	400°F	16
 Chicken Nuggets	8	400°F	8
 Steak (1/2" ribeye)	12	360°F	8 oz each
 Poultry (Chicken breast)	12	360°F	8 oz each
 Fish (Frozen Fish Sticks)	8	400°F	8

PRE-HEAT

Pre-Heat Function:

The "Pre-Heat" function ensures that the NuWave 3Q Brio Digital Air Fryer reaches the desired temperature before you begin cooking your food. The "Pre-Heat" function is the perfect choice for foods that require a crispier finish, such as frozen appetizers, French fries, or chicken wings.

Press the "Pre-Heat" button. The control panel will display "Pre-Heat". Press the arrows above the temperature and time icons before pressing "Start". The default temperature is set to 360°F. If needed, you can manually adjust the cooking temperature and time by pressing the arrows above and below the temperature and time icon.

Once the NuWave 3Q Brio Digital Air Fryer reaches the set temperature, the control panel will display "Ready" and the NuWave 3Q Brio Digital Air Fryer will beep once. The NuWave 3Q Brio Digital Air Fryer will start a countdown of 5 minutes and the number "5" will start flashing. It will remain at this temperature for up to 5 minutes, or until you remove the Fry Pan Basket, whichever comes first. Once the food has been added to the Fry Pan Basket, insert the Fry Pan Basket back in place. This will start the countdown on the set cooking time.

Note: If you remove the Fry Pan Basket at any point during the preheating stage, the NuWave 3Q Brio Digital Air Fryer will automatically pause, start a countdown of 5 minutes until you replace the Fry Pan Basket. If you cook another batch of food shortly after cooking in the NuWave Brio 3Q Digital Air Fryer, you do not need to use the "Pre-Heat" Function as the NuWave 3Q Brio Digital Air Fryer will already be hot. If you wish to cook your food longer, simply place the Base Tray and Fry Pan Basket back into the appliance and continue cooking in 2-3 minute increments until desired consistency has been reached.

OPERATING INSTRUCTIONS (Continued)



Adjusting Temperature:

The NuWave 3Q Brio Digital Air Fryer is set to cook at 360°F by default. To set a different cooking temperature, press the arrows above and below Temp icon. The display will show “360F”. “Temp” will be flashing. To adjust the temperature, continue to press the “Up” and “Down” arrows. You can adjust your temperature in 5-degree increments between 100°F and 400°F.

To quickly adjust the temperature in large increments, simply **hold down** the “Up” or “Down” arrow to adjust the temperature by 50-degree increments. You can change the cooking temperature at any point during the cooking process. Press the arrows above and below the Temp icon. Programed temperature will be displayed. “Temp” will be flashing. Press the “Up” or “Down” arrow until you reach your desired temperature.

Once your temperature has been selected, the NuWave 3Q Brio Digital Air Fryer will automatically adjust to the new temperature and the display will show the remaining cooking time. If no new temperature has been selected within 3 seconds, the NuWave Brio Digital Air Fryer display will once again show the remaining cooking time.



Adjusting Time:

The NuWave 3Q Brio Digital Air Fryer is set to cook for 15 minutes by default. To set a different cooking time, press the up and down arrows above and below the Time icon. The display will show “15”. “Time” will be flashing. To adjust the time, continue to press the “Up” and “Down” arrows. You can adjust your cooking time in 1 minute increments.

To quickly adjust the time in large increments, simply **hold down** the “Up” or “Down” arrow to adjust the time by 10-minute increments, followed by 20-minute increments, followed by 30-minute increments. The minimum selectable cooking time is 1 minute. The maximum selectable cooking time differs depending on the selected cooking temperature.

- 100°F – 345°F maximum cooking time is 99:59 hours
- 350°F – 400°F maximum cooking time is 1 hour

You can change the cooking time at any point during the cooking process. Press the up and down arrows above and below the Time icon. The remaining cooking time will be displayed. Press the “Up” or “Down” arrow until you reach your desired cooking time. Once your cooking time has been selected, the display will show the new remaining cooking time.

Note: After timer reaches 1 minute, the display will begin showing the remaining time in seconds (59, 58, etc.).



Reheat Function:

The default setting is programmed at 360F for 4 minutes. This function is perfect for reheating single portion-sized foods. Press the “Reheat” button, then press “Start”. If needed, you can manually adjust the cooking temperature and time by pressing the arrows above and below the temperature and time icon. When using reheat, you can place the food directly in the basket, any oven safe dish or even foil.

OPERATING INSTRUCTIONS (Continued)

For Best Results

After you have selected your cooking time and temperature and you are ready to add your ingredients to the NuWave Brio Digital Air Fryer: Pull out the Base Tray and Fry Pan Basket from the NuWave Brio Digital Air Fryer. (Fig. 1)

Note: Do not fill more than 4/5 full. Slip the Fry Pan Basket in place in the NuWave Brio Digital Air Fryer. Do not use the Base Tray without the Fry Pan Basket in it. (Fig. 2)

Note: Do not touch the inside of the Base Tray immediately after cooking as the pan can become very hot. Only hold the pan by the handle.

Shaking Food:

Some foods require shaking halfway through cooking. To properly shake the food, hold the handle, remove the Base Tray from the appliance and shake. Once the food has been adequately shaken, slide the Base Tray and Fry Pan Basket back into the NuWave Brio Digital Air Fryer. (Fig. 3)

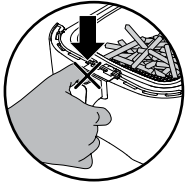

DO NOT PRESS THE DEMOUNTING BUTTON WHILE SHAKING.

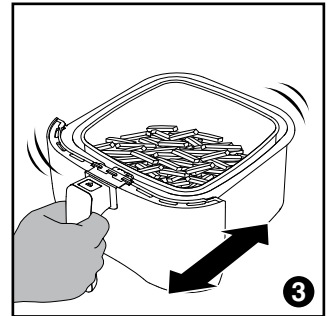
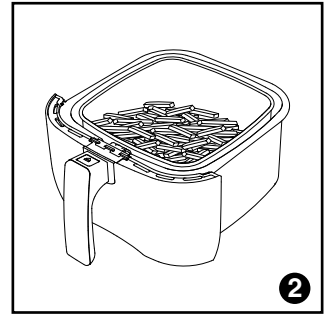
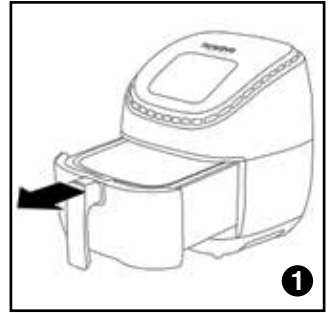

How To Use Grill Pan:

1. Pull out the Fry Pan Basket from the Base Tray and place it on a flat surface.
2. Lift up the safety cover and press the demounting button.
3. Lift the Fry Pan Basket, and replace this with the Grill Pan.
4. To remove Grill Pan or Fry Pan Basket from the Base Tray lift open the safety cover, press the demounting button.

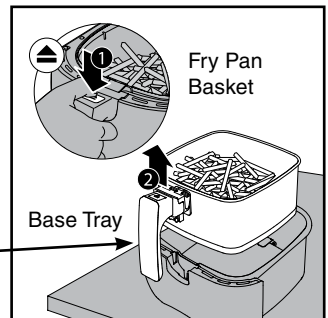
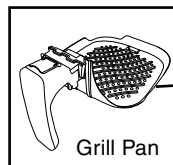

This will reduce the extra weight of the Base Tray and makes it easier to pour smaller foods, such as French fries.

CARE & MAINTENANCE

Cleaning:

Clean the appliance after every use or in between a large amount of batches. The Fry Pan Basket and the Base Tray have a non-stick coating with removable stainless steel basket net. Do not use metal utensils or harsh abrasives when cleaning as this can damage the coating.

- Unplug the appliance and make sure it cools completely.

Note: Remove the Base Tray and Fry Pan Basket, place on a heat resistant surface to help cool the appliance quicker.

- Use a damp cloth to wipe the outside of the appliance.
- Clean the Fry Pan Basket and inside components with a nonabrasive sponge, hot water and mild detergent.

Note: If you place the Base Tray and Fry Pan Basket into the dishwasher, use the top rack only.

Tip: If there is residual food in the Base Tray and Fry Pan Basket, add some hot water and let it soak separately for easier cleaning.

- Clean the inside of the appliance with a nonabrasive sponge and hot water.
- Clean the heating components with a cleaning brush to remove any lingering food.

Storage:

- Unplug the appliance and let it cool down completely.
- Make sure that all the parts are cleaned and dry.
- The NuWave Brio 3Q Digital Air Fryer comes with a special housing underneath for easy and convenient chord storage. You will see a portion sticking out and the rest of chord neatly wound in the housing.

IMPORTANT - Do not immerse unit in water or attempt to cycle through dishwasher. The outer surface may be cleaned by wiping carefully with a damp dishcloth or sponge. Make sure unit has cooled completely prior to cleaning.

Any other servicing should be performed by an authorized service representative.



CARE & USE FOR ACCESSORIES

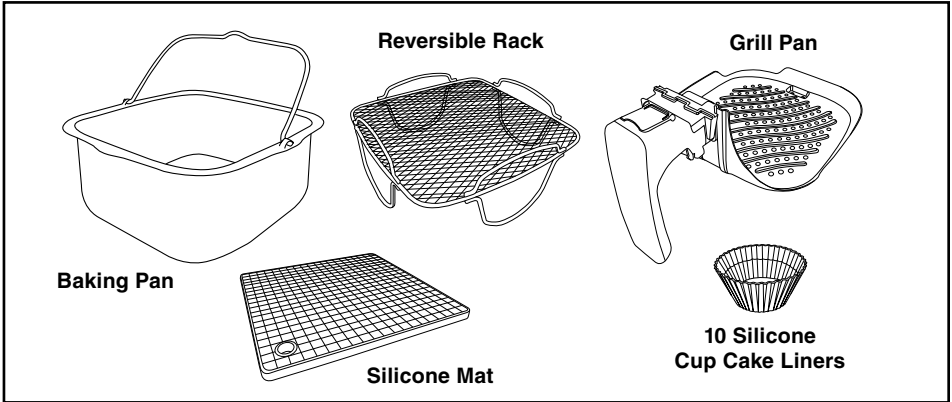

Care & Use:

Before use, wash with mild soap and water or in a dishwasher, top rack only. This should never be cleaned with harsh abrasives nor cut with any sharp objects.

- Do not use steel wool or any sharp objects that may scratch or damage the silicone.
- Do not place silicone products on the top rack of a nor cook on broil in a conventional oven.
- Do not attempt to cut foods while they are in the accessories. Any misuse of the accessories will void the warranty.

Our silicone material can withstand temperatures up to 500°F, but keep in mind that these temperatures are above and beyond the recommended use for this product. Damages caused by this type of usage will not be covered under warranty.

- Clean the Grill Pan, Baking Pan and Reversible Rack with hot soapy water and a non-abrasive sponge or in the dishwasher before first use and after each use. Dry thoroughly. Do not soak the accessories for long periods of time.
- Do not scrub the accessories with steel wool, oven cleaning solutions or use any harsh abrasive cleansers or materials as scratching may occur. Minor scratches or discolor will not impact the pans performance.
- Store in a cool dry place.

Note: Accessories are all optional.

TROUBLESHOOTING GUIDE

PROBLEM	POSSIBLE CAUSE(S)	RESOLUTION(S)
The NuWave Brio Digital Air Fryer does not work.	The appliance is not plugged in. Did not press On/OFF button. Fry Pan Basket is not in the NuWave Brio Digital Air Fryer.	Insert the plug into an appropriate grounded power socket. Press ON/OFF button after settings are selected. Place the Fry Pan Basket in the NuWave Brio Digital Air Fryer.
The ingredients fried in the Fry Pan Basket are not completely cooked.	Too many ingredients were used. The cooking temperature is too low. The cooking time is too short.	Remove some ingredients from the Fry Pan Basket. Smaller batches are fried more evenly. Fry at a higher temperature. Set the NuWave Brio Digital Air Fryer to fry for a longer time.
The food is fried unevenly.	Certain types of ingredients need to be shaken halfway through the preparation time.	Ingredients that are on the top need to be shaken halfway through the preparation time.
Fried snacks are not crispy when they come out of the NuWave Brio Digital Air Fryer.	You used a type of snack meant to be prepared in a traditional deep fryer.	Use snacks designed to be baked in a traditional oven, or lightly brush some olive oil onto the snacks for a crispier result.
I cannot slide the Fry Pan Basket into the appliance properly.	The Fry Pan Basket is overfilled. The Fry Pan Basket is not placed in the Base Tray correctly.	Do not fill the Fry Pan Basket more than 4/5. Push the Fry Pan Basket down into the Base Tray until you hear a click.
White smoke is coming out of the product.	You are frying greasy foods. The pan contains greasy residue from previous uses.	When you are preparing greasy ingredients in the NuWave Brio Digital Air Fryer, large amounts of oil can smoke and infiltrate into the pan. The oil will produce white smoke and the frying pan might become hotter than usual. This will not affect the final cooking effect. White smoke is caused by greasy heating up in the pan. Make sure you clean the frying pan properly after each use.
French fries are fried unevenly in the NuWave Brio Digital Air Fryer.	You did not soak the potato sticks properly before you fried them. You did not use the right potato type.	Soak potato sticks in a bowl of water for at least 30 minutes, take them out and dry them with paper towel. Use fresh potatoes and make sure they stay firm during frying.

TROUBLESHOOTING GUIDE (Continued)

French fries are not crispy when they come out of the NuWave Brio Digital Air Fryer.	The crispiness of the fries depends on the amount of oil and water in the fries.	Make sure you dry the potato sticks properly before you add the oil. Cut the potato sticks smaller for a crispier result. Add slightly more oil for a crispier result.
--	--	--

If the unit needs to be replaced or returned to the manufacturer, please contact our Customer Service Department at:

1-877-689-2838 or email at help@nuwavenow.com

Contact Customer Service if any of these errors occur

Code	E1	E2	E3
Error	Sensor open ended	Sensor short circuit	Over heat

LIMITED WARRANTY

The NuWave Brio® 3Q Digital Air Fryer

THE MANUFACTURER WARRANTIES

The NuWave Brio Digital Air Fryer, including the Base Tray, Fry Pan Basket, Fry Pan Basket Net, along with the optional Baking Pan, Silicone Mat, Silicone Cupcake Liners, Reversible Rack and Grill Pan are to be free from manufacturer defects. All electrical components are warranted for 1 year from the date of purchase, under normal household use, and when operated in accordance with the Manufacturer's written instructions.

The Manufacturer will provide the necessary parts and labor to repair any part of the NuWave Brio Digital Air Fryer at NuWave, LLC Service Department. After the expiration of the warranty, the cost of the labor and parts will be the responsibility of the owner.

THE WARRANTY DOES NOT COVER

The Limited Warranty is voided if repairs are made by an unauthorized dealer and/or the serial number data plate is removed and/or defaced. Normal deterioration of finish due to use or exposure is not covered by this Warranty. This Limited Warranty does not cover failure, damages or inadequate performance due to accident, acts of God (such as lightning), fluctuations in electric power, alterations, abuse, misuse, misapplications, corrosive-type atmospheres, improper installation, failure to operate in accordance with the Manufacturer's written instructions, abnormal use or commercial use. NuWave, LLC reserves the right to void the Limited Warranty, where allowable by law, for products purchased from an unauthorized dealer.

TO OBTAIN SERVICE

The owner shall have the obligation and responsibility to: pay for all services and parts not covered by the warranty; prepay the freight to and from Service Department for any part or system returned under this warranty; and carefully package the product using adequate padding material to prevent damage in transit. The original container is ideal for this purpose. Include in the package the owner's name, address, daytime telephone number, a detailed description of the problem, and your "RGA number." **Call 1-877-689-2838 or email help@nuwavenow.com** to obtain the RGA number (Return Goods Authorization number). Provide the cooking system model & serial number and proof of date of purchase (a copy of the receipt) when making claims under this warranty.

MANUFACTURER'S OBLIGATION

The Manufacturer's obligation under this Limited Warranty is limited, to the extent allowable by law, to repairing or replacing any part covered by this Limited Warranty which upon examination is found to be defective under normal use. The Limited Warranty is applicable only within the continental United States and only to the original purchaser of the manufacturer's authorized channels of distribution. **THE LIMITED WARRANTY MAY NOT BE ALTERED, VARIED OR EXTENDED EXCEPT BY A WRITTEN INSTRUMENT EXECUTED BY THE MANUFACTURER. THE REMEDY OF REPAIR OR REPLACEMENT AS PROVIDED UNDER THIS LIMITED WARRANTY IS EXCLUSIVE. IN NO EVENT SHALL THE MANUFACTURER BE LIABLE FOR ANY CONSEQUENTIAL OR INCIDENTAL DAMAGES TO ANY PERSON, WHETHER OR NOT OCCASIONED BY NEGLIGENCE OF THE MANUFACTURER, INCLUDING WITHOUT LIMITATION, DAMAGES FOR LOSS OF USE, COSTS OF SUBSTITUTION, PROPERTY DAMAGE, OR OTHER MONEY LOSS.**

Some states do not allow the exclusion or limitation of incidental or consequential damages, so the above limitation exclusions may not apply. This Limited Warranty gives specific legal rights, and there may also be other rights which vary from state to state. **EXCEPT AS OTHERWISE EXPRESSLY PROVIDED ABOVE, THE MANUFACTURER MAKES NO WARRANTIES EXPRESSED OR IMPLIED ARISING BY LAW OR OTHERWISE, INCLUDING WITHOUT LIMITATION, THE IMPLIED WARRANTIES OF MERCHANTABILITY AND FITNESS FOR A PARTICULAR PURPOSE TO ANY OTHER PERSON. READ YOUR OWNER'S MANUAL. IF YOU STILL HAVE ANY QUESTIONS ABOUT OPERATION OR WARRANTY OF THE PRODUCT, PLEASE CONTACT NUWAVE, LLC.**

READ YOUR OWNER'S MANUAL: If you still have any questions about operation or warranty of the product, please contact **NuWave, LLC at: 1-877-689-2838 or email help@nuwavenow.com.**

Recipes

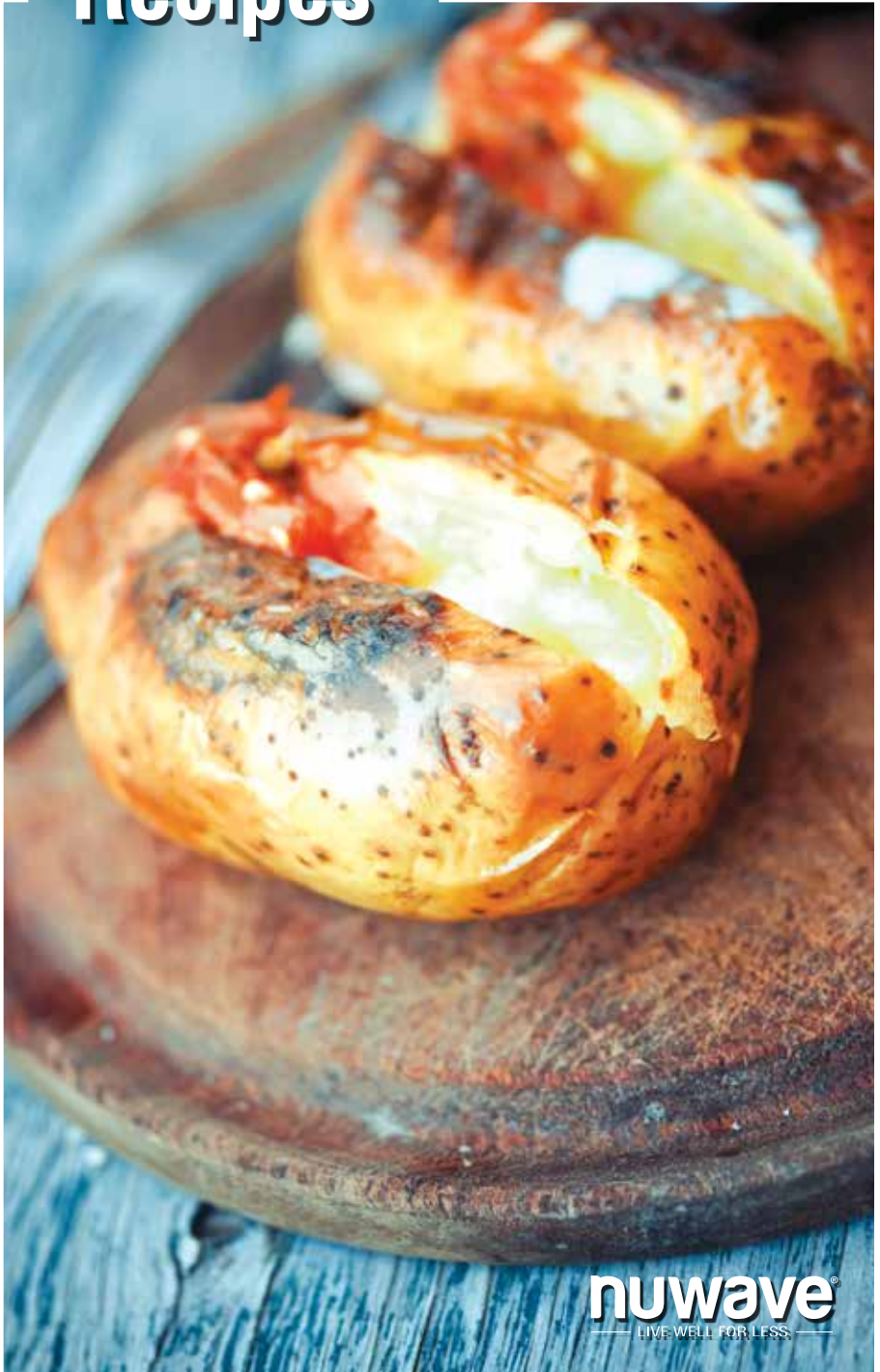

nuwave®
— LIVE WELL FOR LESS. —



Baked Potato (Serves 2)

Prep Time: 5 minutes

Cook Time: 40 minutes

Total: 45 minutes

Temp: 350°F

Ingredients:

2 idaho or russet baking potatoes

1-2 teaspoons olive oil

1 tablespoon salt

1 tablespoon granulated garlic

1 teaspoon parsley

Directions:

1. Wash potatoes and then pierce the skin with a fork.
2. Press "Pre-Heat", set temperature at 350°F and set cooking time at 40 minutes. Press "Start".
3. Drizzle olive oil onto potatoes and rub seasonings evenly over potatoes.
4. Once ready, place coated potatoes in Fry Pan Basket, and cook until fork tender.
5. Cook for an additional 5 minutes if necessary.



Roasted Brussels Sprouts (Serves 4)

Prep Time: 10 minutes

Cook Time: 10 minutes

Total: 20 minutes

Temp: 400°F

Ingredients:

1 pound fresh brussels sprouts

2 teaspoons olive oil

½ teaspoon kosher salt

½ teaspoon black pepper

½ teaspoon granulated garlic

Directions:

1. Remove any tough or bruised outer Brussels sprouts leaves.
2. Trim the stems on the sprouts and cut in half vertically.
3. Rinse sprouts, shake dry and set aside.
4. Press "Pre-Heat", set temperature at 400°F and set cooking time at 10 minutes. Press "Start".
5. Combined salt, pepper garlic and olive oil in bowl.
6. Add sprouts to bowl and toss to coat.
7. Once ready, place sprouts in Fry Pan Basket and cook, pausing occasionally to shake.

Tip: The sprouts are done when the centers are tender and the outsides are caramelized and a bit crispy.



Home Fries (Serves 6)

Prep Time: 40 minutes

Cook Time: 20-25 minutes

Total: 65 minutes

Temp: 360°F

Ingredients:

6 medium russet potatoes

2 tablespoons oil

½ tablespoon granulated garlic

1½ teaspoons paprika

½ teaspoon black pepper

½ teaspoon salt

Directions:

1. Cut potatoes into quarters, soak them in cold water for 20-30 minutes and then pat dry.
2. In a mixing bowl, mix oil, garlic, paprika, salt and pepper and then toss them well with the potato quarters.
3. Press "Pre-Heat", set temperature at 360°F and set cooking time at 20-25 minutes. Press "Start".
4. Once ready, add the potato wedges to Fry Pan Basket skin side down, being careful not to overcrowd.
5. Cook wedges until golden brown.



Air Baked Eggs (Serves 3)

Prep Time: 10 minutes

Cook Time: 7 minutes

Total: 17 minutes

Temp: 300°F

Ingredients:

3 ramekins

6 ounces diced ham

3 large eggs

3-6 spinach leaves (optional)

3 teaspoons milk, divided

non-stick cooking spray or butter

salt and pepper to taste

Directions:

1. Press "Pre-Heat", set temperature at 300°F and set cooking time at 7 minutes. Press "Start".
2. Spray ramekins with non-stick spray.
3. Add spinach, ham, 1 egg, 1 teaspoon milk, salt and pepper to each ramekin.
4. Once ready, place ramekins in Fry Pan Basket and cook.



Air Fried Tortilla Chips (Serves 4)

Prep: 5 minutes
Cook: 4 minutes
Total: 9 minutes
Temp: 390°F

Ingredients:
8 corn tortillas
1 teaspoon olive oil
salt to taste

Directions:

1. Press "Pre-Heat", set temperature at 390°F and set cooking time for 4 minutes. Press "Start".
2. Brush tortillas with olive oil.
3. Cut tortillas into triangles.
4. Once ready, place in Fry Pan Basket and cook.
5. Season with salt and enjoy.

Tip: Serve with your favorite salsa or guacamole.



Sliders (Serves 2)

Prep Time: 5 minutes

Cook Time: 10 minutes

Total: 15 minutes

Temp: 390°F

Ingredients:

8 oz ground beef

2 slices cheddar cheese

2 dinner rolls

¼ teaspoon granulated garlic powder

¼ teaspoon salt

¼ teaspoon pepper

Directions:

1. Press “Pre-Heat”, set temperature at 390°F and set cooking time at 10 minutes. Press “Start”.
2. Form the ground beef into 2 (4 oz). patties and season with salt pepper and garlic.
3. Once ready, add burgers to Fry Pan Basket and cook.
4. Open Air Fryer, top each burger with cheese, set cooking time for 1 minute and cook until cheese has melted.

Tip: You can adjust the cooking time, depending on the level of doneness you prefer your burgers.



Buffalo Wings (Serves 4)

Prep Time: 10 minutes

Cook Time: 20-25 minutes

Total: 35 minutes

Temp: 400°F

Ingredients:

2 pounds chicken wings
(tips removed and wings cut into
drumettes and flats)

½ teaspoon salt

½ teaspoon pepper

½ teaspoon granulated garlic

¼ cup your favorite wing sauce

½ c of vegetable oil

Directions:

1. Press “Pre-Heat”, set temperature at 400°F and set cooking time at 20-25 minutes. Press “Start”.
2. Combine salt, pepper, garlic and oil in bowl and mix well.
3. Add wings to bowl and toss until fully coated.
4. Once ready, place half of the chicken wings in the Fry Pan Basket, and cook, shake the Fry Pan Basket half way through to ensure that the wings are evenly cooking.
5. Transfer cooked wings to large bowl and toss with 2 tablespoons wing sauce.
6. Repeat steps 4-5 with remaining wings and sauce.



Chicken Kiev (Serves 2)

Prep Time: 10 minutes

Cook Time: 25 minutes

Total: 35 minutes

Temp: 350°F

Ingredients:

1 medium chicken breast

4 oz soft cheese

½ teaspoon chopped garlic

1 teaspoon parsley, divided

1 medium egg, beaten

Breadcrumbs

Salt and pepper to taste

Directions:

1. Combine cheese, garlic and ½ teaspoon parsley in small bowl; set aside.
2. Combine breadcrumbs, salt, pepper and remaining parsley.
3. Using meat tenderizer, pound chicken flat brush chicken with beaten egg, place cheese mixture in center of breast fold the chicken around cheese mixture to seal. Dip in the beaten egg. Roll in the prepared breadcrumbs ensuring all sides are coated. Place in freezer for 5 minutes.
4. Press "Pre-heat" 350°F and set for 25 minutes press start.
5. Place chicken in small, oven-safe dish or line Fry Pan Basket with foil before adding the chicken to the Fry Pan Basket.
6. Once ready, place chicken in Fry Pan Basket, and cook.

Tip: Use garlic and herb flavored cheese for maximum flavor. Wrap the chicken in plastic wrap when tenderizing to minimize the mess. Placing the chicken in a small, oven-safe dish inside the NuWave Brio Digital Air Fryer or lining the Fry Pan Basket with foil helps minimize the mess.



Chicken Satay (Serves 4)

Prep Time: 15 minutes
Cook Time: 6-8 minutes
Total: 25 minutes
Temp: 390°F

Ingredients:

1 pound boneless chicken thighs
½ cup soy sauce
½ cup pineapple juice
¼ cup sesame oil
4 garlic cloves, chopped fine
4 scallions, chopped
1 tablespoon grated ginger
2 teaspoons toasted sesame seeds
1 pinch black pepper

Directions:

1. Cut each thigh into strips, trim excess fat.
2. Combine all the other ingredients into a large mixing bowl and mix well.
3. Place chicken onto skewers.
4. Add skewered chicken to mixing bowl and spoon marinade onto chicken to coat all sides.
5. Cover and refrigerate chicken for at least 2 hours, up to 24 hours.
6. Press "Pre-Heat", set temperature at 390°F and set cooking time at 6-8 minutes. Press "Start".
7. Once ready place skewers in the Fry Pan Basket and cook.
8. Repeat steps 6-7 with remaining skewers.

Tip: If using wooden skewers, soak the skewers in water before adding chicken to keep them from burning.



Grilled Chicken Tenders (Serves 3)

Prep Time: 5 minutes

Cook Time: 15 minutes

Total: 20 minutes

Temp: 390°F

Ingredients:

½ pound boneless chicken tenderloins

¼ cup creamy caesar dressing

1 tablespoon olive oil

Dash garlic powder

½ teaspoon dried basil leaves

1 teaspoon dried minced onion

Dash pepper

Directions:

1. Rinse chicken and pat dry.
2. Combine chicken with all remaining ingredients in bowl or food storage bag.
3. Seal or cover chicken and refrigerate for 1-2 hours.
4. Press "Pre-Heat", set temperature at 390°F and set cooking time at 15 minutes. Press "Start".
5. Once ready, place chicken in Fry Pan Basket, and cook, halfway through to flip the tenders to ensure they are evenly cooked.



Parmesan Chicken Tenders (Serves 4)

Prep Time: 10 minutes

Cook Time: 8-12 minutes

Total: 22 minutes

Temp: 330°F

Ingredients:

non-stick cooking spray

¼ cup all-purpose flour

2 large eggs

½ cup finely shredded parmesan cheese

1 cup coarse dry breadcrumbs

1 pound chicken tenders

1 tablespoon Italian seasoning

1 teaspoon garlic powder

¼ teaspoon salt

Directions:

1. Press “Pre-Heat”, set temperature at 330°F and set cooking time at 8-12 minutes. Press “Start”.
2. Place flour in shallow dish.
3. Lightly beat eggs in separate shallow dish.
4. Combine Parmesan and breadcrumbs in separate shallow dish.
5. In medium bowl, toss chicken tenders in Italian seasoning, garlic powder and salt.
6. Coat each chicken tender in flour, shaking off any excess.
7. Dip tender in egg and let any excess drip off.
8. Roll tender in breadcrumb mixture.
9. Once ready, spray Fry Pan Basket with non-stick cooking spray and place half of the tenders in the Fry Pan Basket. Set remaining half aside for later.
10. Generously coat tops of each tender with non-stick cooking spray.
11. Halfway through carefully turn each tender and top with more cooking spray.
12. Ensure cooking time is 4 minutes, and cook until outside is crisp and tenders are cooked through.
13. Repeat steps 9-12 with remaining tenders.



Roasted Cornish Game Hen w/Honey Mustard Glaze (Serves 4)

Prep: 15 minutes

Cook: 20 minutes

Total: 35-40 minutes

Temp: 400°F

Ingredients:

1 (1½ pound) cornish hen

½ teaspoon kosher salt

½ teaspoon freshly ground black

Pepper

1 bay leaf

4 garlic cloves, peeled & smashed

2 teaspoon dried thyme

½ teaspoon chili flakes

2 tablespoons olive oil

¼ cup honey

¼ cup stone ground dijon mustard

1½ teaspoons balsamic vinegar

½ teaspoon ground cumin

1 tablespoon fresh cilantro, chopped
(optional)

Directions:

1. Press "Pre-Heat", set temperature at 400°F and set cooking time at 20 minutes. Press "Start".
2. Season hen inside and out with salt and pepper.
3. Place bay leaf, garlic, thyme and chili flakes inside the cavity of the hen.
4. Brush hen with oil.
5. Once ready, place hen, breast side down, in Fry Pan Basket and roast.
6. Meanwhile, combine the honey, mustard, vinegar, cumin and cilantro in a bowl.
7. Brush over the hen.
8. Continue cooking for an additional 5 minutes.

Tip: Check the hen after roasting to see if the leg pulls away easily from the body and the meat is no longer pink. Cover with foil, and flip half way through. If the meat is still pink, roast for an additional 5-10 minutes.



Cajun Shrimp (Serves 2)

Prep Time: 5 minutes

Cook Time: 6 minutes

Total: 11 minutes

Temp: 390°F

Ingredients:

½ pound shrimp, peeled and deveined

¼ teaspoon cayenne pepper

½ teaspoon old bay seasoning

¼ teaspoon smoked paprika

1 tablespoon olive oil

pinch of salt

Directions:

1. Press “Pre-Heat”, set temperature at 390°F and set cooking time at 6 minutes. Press “Start”.
2. Add all ingredients to mixing bowl and mix until shrimp is completely coated.
3. Once ready, place shrimp in Fry Pan Basket and cook.



Chimichurri Skirt Steak (Serves 2)

Prep Time: 1 hr 30 minutes

Cook Time: 10 minutes with 5 minutes rest

Total: 1 hr 45 minutes

Temp: 390°F

Sauce Ingredients:

1 bunch flat leaf parsley, roughly chopped
(about 1 cup, packed)

5 large garlic cloves, roughly chopped
(about 3 tablespoons)

1 tablespoon dried oregano

1 teaspoon crushed red pepper flakes

½ cup distilled white vinegar

½ cup extra virgin olive oil

1 teaspoon salt

1 teaspoon pepper

Steak Ingredients:

1 pound skirt steak

salt and pepper to taste

Directions:

1. Place all sauce ingredients in food processor or blender and blend until just combined; set aside.
2. Place steak in bowl or container.
3. Add 4 tablespoons chimichurri sauce to container, spreading evenly on all sides of the steak
4. Let steak marinate at room temperature for 1 hour, or in the refrigerator for at least 2 hours, or overnight.
5. Press “Pre-Heat”, set temperature at 390°F and set cooking time at 8-10 minutes. Press “Start”.
6. Once ready, season steak with salt and pepper and place in Fry Pan Basket.
7. Press Start cook steak. Add additional time if you prefer your steak more done.
8. Let steak rest for 5 minutes, then slice against the grain.
9. Serve steak with remaining chimichurri sauce.

Tip: Marinate the steak in a container made from non-reactive materials, such as plastic, enamel, glass or stainless steel. If you marinate the steak in the refrigerator, allow the steak to return to room temperature before cooking. This should take about 30 minutes. Chimichurri sauce is best served at room temperature.



Grilled Ham and Cheese (Serves 2)

Prep Time: 10 minutes
Cook Time: 4-5 minutes
Total: 15 minutes
Temp: 360°F

Ingredients:
4 slices white bread
2 slices American cheese
2 slices of thinly sliced ham
¼ cup melted butter

Directions:

1. Press “Pre-Heat”, set temperature at 360°F and set cooking time at 4-5 minutes. Press “Start”.
2. Brush each bread slice with butter on one side.
3. Layer ham and cheese on bread and assemble sandwiches with the buttered sides of the bread out.
4. One ready, place sandwiches in Fry Pan Basket and cook until golden brown.

Tip: Use precooked bacon or sliced turkey instead of ham for a different flavor.



Tortilla Crusted Tilapia (Serves 2)

Prep Time: 5 minutes

Cook Time: 15 minutes

Total: 20 minutes

Temp: 375°F

Ingredients:

1 whole jalapeño, seeded & deveined

$\frac{3}{4}$ cup cilantro

$\frac{1}{2}$ teaspoon chili powder

$\frac{1}{4}$ teaspoon cumin

$\frac{1}{4}$ teaspoon onion powder

1 teaspoon seasoning salt

18 whole tortilla chips

1 whole large egg, beaten

2 whole tilapia fillets

Directions:

1. Press "Pre-Heat", set temperature at 375°F and set cooking time at 12-15 minutes. Press "Start".
2. Add jalapeño, cilantro, chili powder, cumin, onion powder and salt to food processor and mix to combine.
3. Add tortilla chips to food processor and mix until mixture forms small chunks.
4. Transfer chip mixture to plate.
5. Place beaten egg in small dish.
6. Dredge each tilapia filet in egg, then chip mixture, ensuring mixture adheres to each side.
7. Once ready, spray Fry Pan Basket with non-stick cooking spray and place breaded filets in Fry Pan Basket and cook till golden.



Tuna Sliders (Serves 2)

Prep: 25 minutes

Cook: 6-10 minutes

Total: 35 minutes

Temp: 390°F

Ingredients:

2 (6.4-oz) pouches chunk light tuna in Water

1 Egg

¼ teaspoon black pepper

¼ teaspoon granulated garlic

¼ cup dry, unseasoned breadcrumbs

Directions:

1. Press "Pre-Heat", set temperature at 390°F and set cooking time at 6-10 minutes. Press "Start".
2. Combine all ingredients in medium bowl and mix to combine.
3. Shape tuna mixture into 8 (½-inch thick) patties.
4. Once ready, add patties to Fry Pan Basket, press Start and cook, halfway through to flip the sliders to ensure they are evenly cooked.



Turkey Sliders (Serves 2)

Prep Time: 5 minutes

Cook Time: 10 minutes

Total: 15 minutes

Temp: 390°F

Ingredients:

1 pound ground turkey

2 slices colby jack cheese, cut in half

4 mini rolls

½ teaspoon granulated garlic powder

½ teaspoon salt

½ teaspoon pepper

Directions:

1. Press “Pre-Heat”, set temperature at 390°F and set cooking time at 10 minutes. Press “Start”.
2. Form ground turkey into 4 (4-ounce) patties and season with salt, pepper and garlic.
3. Once ready, add burgers to Fry Pan Basket and cook. Halfway through to flip the tenders to ensure they are evenly cooked.
4. Open Air Fryer and top each burger with cheese.
5. Set cooking time at 1 minute, press Start and cook burgers until cheese has melted.



Pork Loin Sandwiches (Serves 4)

Prep: 20 minutes

Cook: 15 minutes

Total: 35 minutes

Temp: 350°F

Ingredients:

1 (1½ pounds) pork loin

4 buns, toasted

1 teaspoon salt

1 teaspoon pepper

½ teaspoon granulated garlic

½ teaspoon crushed red pepper

Non-stick cooking spray

Directions:

1. Cut pork loin in half to fit in the Fry Pan Basket.
2. Combine all seasonings in bowl.
3. Press "Pre-Heat", set temperature at 350°F and set cooking time at 15 minutes. Press "Start".
4. Once ready, arrange pork loin halves in Fry Pan Basket.
5. Spray pork with non-stick spray and apply seasonings.
6. Cook pork, halfway through to flip the pork loins to ensure they are evenly cooked.
7. After cooking is complete, allow pork loin to rest for 5-10 minutes.
8. Slice pork loin against the grain and assemble sandwiches on toasted buns.



Citrus Green Beans (Serves 4)

Prep Time: 10 minutes

Cook Time: 10 minutes

Total: 20 minutes

Temp: 390°F

Ingredients:

1 pound green beans, washed
& de-stemmed

Juice from 1 lemon

Pinch salt

Black pepper to taste

¼ teaspoon olive oil

Directions:

1. Press "Pre-Heat", set temperature at 390°F and set cooking time at 10 minutes. Press "Start".
2. Once ready, place green beans in Fry Pan Basket
3. Squeeze lemon juice onto green beans.
4. Season green beans with salt and pepper and top with oil.



Crispy Tofu (Serves 6)

Prep: 10 minutes

Cook: 8 minutes

Total: 18 minutes

Temp: 350°F

Ingredients:

12 ounces low fat, extra firm tofu

1 teaspoon sesame oil

1 teaspoon teriyaki sauce

1 tablespoon honey

2 tablespoons Sriracha sauce

2 tablespoons low sodium soy sauce

1 teaspoon oil

Directions:

1. Cut tofu into 1-inch cubes; set aside in medium bowl.
2. Combine all remaining ingredients and pour over tofu, mixing to combine.
3. Let tofu marinate for at least 30 minutes, tossing a few times.
4. Press "Pre-Heat", set temperature at 350°F and set cooking time at 8 minutes. Press "Start".
5. Once ready, add marinated tofu to Fry Pan Basket, and cook, halfway through to flip the tofu to ensure they are evenly cooked.



Air Fryer Curry Calamari (Serves 4)

Prep: 15 minutes

Cook: 8-10 minutes

Total: 25 minutes

Temp: 390°F

Ingredients:

16 ounces Raw, Boneless Squid

½ cup cornstarch

¼ cup olive oil

½ teaspoon paprika

½ teaspoon curry powder

1 cup water

Non-stick cooking spray

Directions:

1. Cut squid into rings.
2. Combine all remaining ingredients and whisk together until smooth.
3. Add squid to cornstarch mixture and stir to coat.
4. Press “Pre-Heat”, set temperature at 390°F and set cooking time at 8-10 minutes. Press “Start”.
5. Spray Fry Pan Basket with non-stick spray and add one third of the squid to Fry Pan Basket.
6. Cook squid, halfway through to flip the calamari to ensure they are evenly cooked.
7. Repeat steps 5-6 for remaining batches.



Party Meatballs (Serves 4)

Prep: 20 minutes

Cook: 8-10 minutes

Total: 30 minutes

Temp: 400°F

Ingredients:

1 pound ground beef

¾ cup tomato ketchup

1 tablespoon tabasco sauce

2 teaspoons worcestershire sauce

¼ cup vinegar

1 tablespoon lemon juice

½ cup brown sugar

½ teaspoon dry mustard

3 gingersnaps, crushed

Directions:

1. Add all seasonings to large mixing bowl and mix to combine.
2. Add beef to bowl and mix well.
3. Press "Pre-Heat", set temperature at 400°F and set cooking time at 8-10 minutes. Press "Start".
4. Form beef into medium sized meatballs.
5. Once ready, place meatballs in Fry Pan Basket and cook.

Tip: Do not overcrowd the Fry Pan Basket. Cook in batches if you need to.



Kale Chips (Serves 4)

Prep: 5 minutes

Cook: 2-3 minutes

Total: 8 minutes

Temp: 390°F

Ingredients:

1 head kale

1 teaspoon olive oil

1 teaspoon soy sauce

Directions:

1. Press “Pre-Heat”, set temperature at 390°F and set cooking time at 2-3 minutes. Press “Start”.
2. Remove the center stem from kale and cut leaves into 1½-inch pieces.
3. Wash kale pieces and dry thoroughly.
4. Toss kale with the olive oil and soy sauce.
5. Once ready, place kale in Fry Pan Basket, and cook, halfway through to flip the kale chips to ensure they are evenly cooked.

Tip: Place the Reversible Rack on top of the kale to prevent the leaves from moving during the cooking process.



Roasted Tomatoes (Serves 4)

Prep: 5 minutes
Cook: 20 minutes
Total: 25 minutes
Temp: 320°F

Ingredients:

2 tomatoes
Parsley to taste
Oregano to taste
Basil to taste
Thyme to taste

Rosemary to taste
Sage to taste
Black pepper to taste
Non-stick cooking spray
½ tablespoon extra-virgin olive oil

Directions:

1. Press “Pre-Heat”, set temperature at 320°F and set cooking time at 20 minutes. Press “Start”.
2. Wash tomatoes and cut in half.
3. Once ready, spray bottoms of tomato halves with non-stick spray and place tomatoes in Fry Pan Basket.
5. Drizzle olive oil onto tomatoes and top with seasonings and cook.
6. Check for doneness and cook for additional 3-5 minutes if needed.



Roasted Root Vegetables (Serves 4)

Prep Time: 10 minutes

Cook Time: 20 minutes

Total: 30 minutes

Temp: 400°F

Ingredients:

2 carrots, peeled, halved & cut into chunks

2 parsnips, peeled, halved & cut into chunks

½ butternut squash, de-seeded, peeled & cut into chunks

4 celery stalks, peeled and cut into chunks

1 teaspoon ground cumin seeds

1 teaspoon ground coriander

1 tablespoon vegetable oil

1 teaspoon granulated garlic

Salt and pepper to taste

Directions:

1. Press “Pre-Heat”, set temperature at 400°F and set cooking time at 20 minutes. Press “Start”.
2. Place all vegetables into bowl and drizzle with vegetable oil.
3. Add cumin seeds, coriander, garlic, salt and pepper to bowl and stir well to combine.
4. Once ready, place vegetables in Fry Pan Basket, and cook, pausing halfway through to shake.



Apple Pie Egg Rolls (Yield 6 Egg Rolls)

Prep Time: 15 minutes

Cook Time: 8-10 minutes

Total: 25 minutes

Temp: 390°F

Ingredients:

8 tablespoons unsalted butter

3 granny smith apples, peeled, cored,
and cut into ¼-inch cubes

½ tablespoon vanilla extract

½ teaspoon cinnamon

½ cup sugar

Pinch salt

2 tablespoons all-purpose flour

2 tablespoons lemon juice

6 egg roll wrappers

¼ stick melted butter

Non-stick cooking spray

Directions:

1. Add unsalted butter, apples, vanilla, cinnamon, sugar, salt, flour, and lemon juice to saucepan bring to a simmer on medium-high heat and simmer for 2-3 minutes.
2. Reduce heat to medium-low and continue simmering for 2-3 minutes.
3. Remove pan from heat and let apple mixture cool; set aside.
4. Lay out egg roll wrappers on cutting board in a diamond shape.
5. Brush edges of wrappers with melted butter.
6. Place about 2 tablespoons of apple mixture in center of each wrapper, leaving about 1-inch of space along the edges.
7. Fold end of wrapper nearest to you over the filling to seal, then fold sides over and roll the wrapper into a tight cylinder shape.
8. Spray NuWave Brio Basket with non-stick cooking spray.
9. Place egg rolls in NuWave Brio Basket and cook at 390°F for 8-10 minutes. Serve immediately.

Tip: Sprinkle the egg rolls with powdered sugar for a nice final touch.



Banana and Nutella Wontons (Serves 2)

Prep Time: 10 minutes

Cook Time: 6-8 minutes

Total: 20 minutes

Temp: 350°F

Ingredients:

8 wonton wrappers
8 teaspoons nutella
1 banana

1 egg
1 teaspoon water
Cinnamon sugar or powdered sugar
for garnish

Directions:

1. Press “Pre-Heat”, set temperature at 350°F and set cooking time at 6-8 minutes. Press “Start”.
2. Add egg and water to small bowl and mix together to make egg wash.
3. Place 1 teaspoon Nutella in center of wonton wrapper.
4. Slice banana and place atop Nutella.
5. Brush egg wash along two sides of the wonton.
6. Seal wonton wrapper by folding the sides together.
7. Once ready, place wontons in Fry Pan Basket and cook.
8. Once the wontons have sufficiently browned, carefully remove from the Air Fryer and dust with cinnamon sugar or powdered sugar.



Pineapple Crescents (Serves 4)

Prep Time: 20 minutes

Cook Time: 10 minutes

Total: 30 minutes

Temp: 350°F

Ingredients:

½ pineapple

½ cup shredded coconut

1 small sprig fresh mint

1 cup vanilla yogurt

Directions:

1. Cut pineapple into ½-inch thick slices, then cut slices in half and remove the core.
2. Press “Pre-Heat”, set temperature at 350°F and set cooking time at 10 minutes. Press “Start”.
3. Dip pineapple slices into shredded coconut.
4. Once ready, gently place pineapple in Fry Pan Basket and cook.
5. While pineapple cooks, finely dice mint leaves and stir into vanilla yogurt.
6. Serve pineapple with yogurt dip.



Crescent Rolls (Serves 4)

Prep Time: 5 minutes

Cook Time: 7 minutes

Total: 12 minutes

Temp: 350°F

Ingredients:

1 Package refrigerator crescents

(8 Crescents)

Non-stick cooking spray

Directions:

1. Press “Pre-Heat”, set temperature at 350°F and set cooking time at 12 minutes. Press “Start”.
2. Place small square of aluminum foil on Fry Pan Basket.
3. Lightly spray foil with cooking spray.
4. Once ready, place crescent dough in Fry Pan Basket, and bake.
5. Remove rolls from Fry Pan Basket and enjoy.

nuwave[®]
— LIVE WELL FOR LESS —



NuWave Brio[®] 3Q Freidora Digital de Aire



Manual del Usuario

GUÍA

La siguiente guía indica la cantidad de tiempo, temperatura y peso para los diferentes tipos de comida que se enlistan a continuación:

Tipo de Comida	Mover/ Voltear	Tiempo (mins)	Temp (°F)	Cantidad Sugerida	Notas Adicionales
Barritas Congeladas de Pan Francés	Voltear	8-10	380	8 oz	/
Tortitas de Hash Brown Congeladas	Voltear	18-25	360	1-3 tortitas	/
Rollos de Canela	/	10-12	350	1-4 rollos	Cubrir con aluminio (a la ½ del tiempo)
Papas a la Francesa Delgadas Congeladas	Mover	8-14	400	16 oz	/
 Papas a la Francesa Congeladas	Mover	14-17	400	16 oz	Corte Medio
 Papas a la Francesa Caseras	Mover	20-25	360	12 oz	Remojar en Agua por 30 minutos
Gajos de Papa Caseros	Mover	20-25	360	12 oz	Remojar en Agua por 30 minutos
Cubos de Papa Caseros	Mover	15-20	360	12 oz	Remojar en Agua por 30 minutos
 Carne (½" ribeye)	Voltear	12-18	360	1-2 (8 oz c/u)	/
Chuletas de Cerdo (con hueso)	Voltear	15-20	375	1-2 (8-12 oz c/u)	/
Hamburguesas Congeladas	Voltear	16-20	360	1-2 (5 oz c/u)	/
Hamburguesas Frescas	Voltear	12-16	360	1-3 (8 oz c/u)	/
Salchicha Italiana	Voltear	13-15	400	1-4 (4 oz c/u)	/
Alitas de Pollo	Mover	20-25	390	12 oz	/
 Aves	Voltear	11-14	360	1-2 (8 oz c/u)	Pechuga de Pollo
Tater Tots Congeladas	Mover	6-8	360	12 oz	/
Rollos Primavera	Mover	6-8	360	12 oz	/
 Nuggets de Pollo	Mover	8-12	400	8 oz	/
 Pescado	Voltear	11-14	400	8 oz	Palitos de Pescado Congelados
Chiles Rellenos	Mover	8-10	360	8 oz	/
Aros de Cebolla	Mover	12-16	360	12 oz	/
Champiñones Empanizados	Mover	8-10	390	8 oz	/
Palitos de Mozzarella/ Calabacin	Mover	5-7	360	12 oz	/

Nota: Los tiempos de cocción actuales pueden variar dependiendo del tamaño y forma de los ingredientes utilizados. Los tiempos de cocción enlistados deberán ser utilizados como una guía. Ajuste los niveles cuanto sea necesario para cubrir sus necesidades. De acuerdo con la FDA, la temperatura interna segura es de 165°F para aves y de 160°F para cerdo.

MEDIDAS DE SEGURIDAD IMPORTANTES

LEE TODAS LAS INSTRUCCIONES

Al usar unidades eléctricas, siempre se deben seguir las precauciones básicas de seguridad, incluidas las siguientes:

1. No toque las superficies calientes. Utilice mangos o perillas.
2. Para protegerse contra descargas eléctricas, no sumerja el cable, los enchufes ni la Brio en agua u otros líquidos.
3. No opere ningún aparato con un cable o enchufe dañado o después de que el aparato funcione mal o haya sido dañado de alguna manera. Devuelva el aparato al centro de servicio autorizado más cercano para que lo examinen, reparen o ajusten.
4. Si el cable de alimentación está dañado, no intente utilizar la Brio.
5. Es necesaria una estrecha supervisión cuando se utiliza cualquier aparato cerca de niños. Este dispositivo no está diseñado para ser utilizado por personas (incluidos niños) con capacidades físicas, sensoriales o mentales reducidas, o con falta de experiencia y conocimiento, a menos que sean supervisados o instruidos sobre el uso del dispositivo por una persona responsable de su seguridad.
6. El uso de otros accesorios que no estén destinados a ser utilizados con la Brio no es recomendable. Hacerlo puede dañar la Brio y causar accidentes.
7. **NO APTO PARA USO EN EXTERIORES.**
8. No utilice el aparato para otro uso que no sea el previsto.
9. No deje que el cable cuelgue del borde de la mesa o mostrador ni que toque superficies calientes.
10. No lo coloque sobre ni cerca de un quemador caliente, de gas o eléctrico, ni en un horno caliente.
11. Se debe tener mucho cuidado al mover la Brio si contiene aceite caliente u otros líquidos calientes.
12. Para desconectarla, apague la Brio, luego retire el enchufe del contacto de pared.
13. Durante la fritura al aire, se libera vapor caliente de la salida de aire. Mantenga las manos y la cara alejadas del vapor y de la salida de aire. Además, tenga cuidado con el vapor caliente y el aire cuando retire la cacerola.
14. Asegúrese de que los ingredientes preparados en la Brio salgan de color marrón dorado en lugar de marrón oscuro y no se quemen. Retire cualquier resto quemado de la canastilla durante la limpieza y antes de cada uso.

MEDIDAS DE SEGURIDAD IMPORTANTES (Continuación)

15. Nunca ponga la Brio contra la pared u otros aparatos. Debe haber al menos 3 pulgadas de espacio libre para el lado posterior, los lados izquierdo/derecho y el lado superior de la Brio. No coloque nada encima de la Brio.
16. Desenchufe la Brio del contacto cuando no esté en uso y antes de limpiarla. Permita que la Brio se enfríe antes de limpiar, poner o quitar partes.
17. La Brio no está diseñada para ser operada por medio de un temporizador externo o un sistema de control remoto separado.
18. PARA USO DOMÉSTICO SOLAMENTE.
19. Mantenga el manual a la mano para futuras referencias.

VEA LAS INSTRUCCIONES DE OPERACIÓN ANTES DE USAR

Se proporciona un cable de suministro de energía corto (o cable de suministro de energía desmontable) para reducir el riesgo resultante de enredarse o tropezar con un cable más largo. Los cables de alimentación desmontables más largos o los cables de extensión están disponibles y se pueden usar si se tiene cuidado al hacerlo. Si se usa un cable de alimentación desmontable más largo o un cable de extensión:

1. La calificación eléctrica marcada del cable de extensión debe ser al menos tan grande como la calificación eléctrica del aparato.
2. El cable más largo debe estar dispuesto de modo que no se cuelgue sobre la encimera o sobre una mesa donde se pueda tirar o tropezar involuntariamente. La Brio debe operarse en una toma eléctrica separada de otros aparatos operativos debido a limitaciones del voltaje. El aparato tiene un enchufe polarizado (una cuchilla es más ancha que la otra). Para reducir el riesgo de descarga eléctrica, este enchufe está diseñado para encajar en una toma de corriente polarizada de una sola manera. Si el enchufe no encaja completamente en el tomacorriente, invierta el enchufe. Si aún así no encaja, comuníquese con un electricista calificado. No intente modificar el enchufe de ninguna manera.
3. Si el aparato es del tipo con conexión a tierra, el juego de cables o el cable de extensión debe ser un cable de 3 hilos con conexión a tierra.

MEDIDAS DE SEGURIDAD IMPORTANTES (Continuación)

GUARDE ESTAS INSTRUCCIONES

Lea y comprenda todo el manual antes de usar la Brio.

NO UTILICE LA UNIDAD PARA OTRO USO QUE NO SEA EL PREVISTO.

Nota: Coloque la Brio en una superficie que sea horizontal, uniforme y estable. Este aparato está diseñado para uso doméstico normal. No está diseñado para usarse en entornos como de personal de cocina de tiendas, oficinas, granjas u otros entornos de trabajo. Tampoco está destinado a ser utilizado por clientes en hoteles, moteles, bed and breakfast y entornos no residenciales.

AVISO: EL FALLO DE SEGUIR CUALQUIERA DE LAS MEDIDAS DE SEGURIDAD IMPORTANTES, ADICIONALES O LAS INSTRUCCIONES PARA UN USO SEGURO ES UN ABUSO DE SU BRIO QUE PUEDE ANULAR SU GARANTÍA Y CREAR EL RIESGO DE LESIONES GRAVES.

	⚠ ADVERTENCIA
	En caso de otros problemas, desenchúfela inmediatamente y comuníquese con el Departamento de Servicio al Cliente. 1-877-689-2838 * help@nuwavenow.com



MEDIDAS DE SEGURIDAD ADICIONALES

1. No coloque la Brio cerca de materiales inflamables, unidades de calefacción, o ambientes húmedos.
2. La altura de los ingredientes colocados en la canastilla debe cumplir con las instrucciones enumeradas en las "Instrucciones de Funcionamiento".
3. No coloque ningún otro recipiente en la cacerola. No reemplace ninguna parte con otros contenedores.
4. Es normal que algo de humo escape de la Brio cuando se calienta por primera vez.
5. Si sale mucho humo del respiradero de aire durante el funcionamiento, desenchufe la Brio de inmediato y comuníquese con Servicio al Cliente.*
6. No mueva la Brio mientras esté en funcionamiento. Sólo después de que la Brio se haya enfriado completamente debe intentarse moverla. Siempre espere a que la freidora de aire se enfríe antes de manipularla.
7. Los niños deben ser supervisados para asegurarse de que no jueguen con el aparato.
8. Nunca use una toalla u otro material u objeto para bloquear las salidas de aire.

MEDIDAS DE SEGURIDAD ADICIONALES (Continuación)

1. Si surge algún problema durante la operación, cualquier servicio DEBE ser realizado por NuWave, LLC o autorizado por el fabricante para reparaciones.
2. El aparato no está diseñado para ser operado por medio de un temporizador externo o un sistema de control remoto separado.
3. No desarme la Brio ni reemplace ninguna pieza sin el consentimiento previo por escrito del fabricante. Do not use metal utensils with the coated Fry Pan Basket or Fry Pan Basket Net as this can damage the surface.
4. No utilice utensilios de metal en la cacerola recubierta o en la canastilla, ya que esto puede dañar la superficie.
5. Asegúrese de que la Brio esté siempre limpia antes de cocinar.

***Departamento de Servicio al Cliente:
1-877-689-2838 • help@nuwavenow.com**

 PRECAUCIÓN	
	<ul style="list-style-type: none">• Siempre coloque los alimentos a cocinar en la canastilla para evitar que entren en contacto con los componentes de calor.• No tape las ventilaciones mientras esté funcionando.• No vierta aceite en la cacerola o en la canastilla, ya que podría generarse un riesgo de incendio.• Nunca toque el interior del aparato mientras esté funcionando.

DESCRIPCIÓN DE LAS PARTES

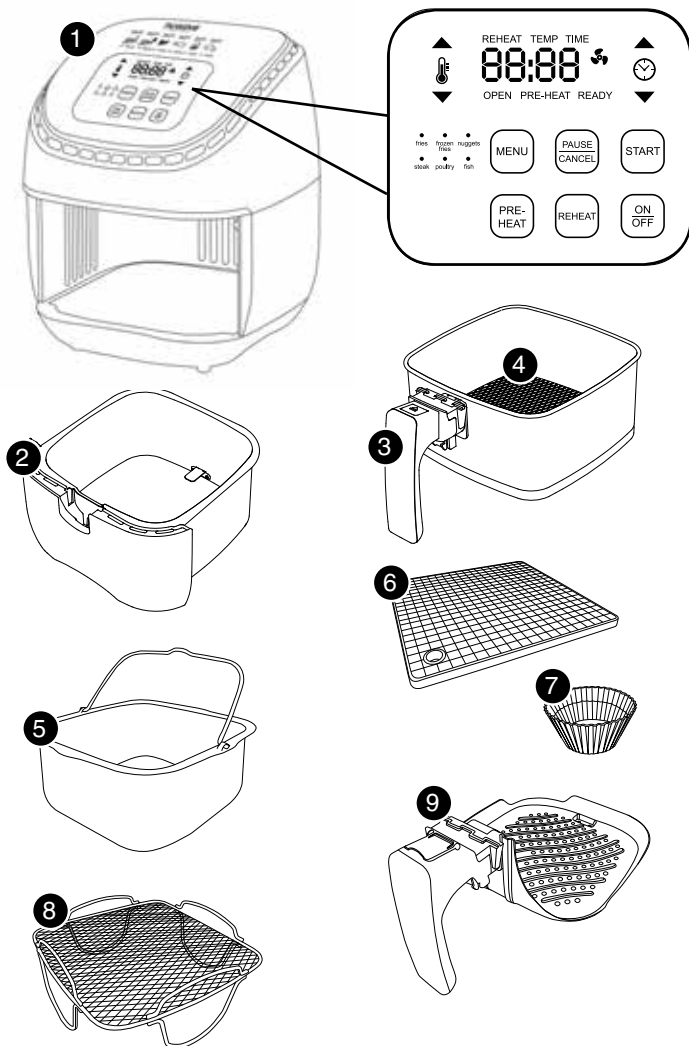

1. **La Base del La Freidora de Aire**
Parte #: 36231

2. **Sartén**
Parte #: 36232

3. **Canastilla**
Parte #: 36233

4. **Malla de la Canastilla**
Parte #: 36204

5. **Parrilla para Hornear***
Part #: 36207

6. **Tapete de Silicón***
Part #: 36208

7. **Molde de Silicón para Cup Cake ***
Part #: 36209

8. **Rejilla Reversible***
Part #: 36206

9. **Parrilla para Asado***
Part #: 36205

*Opcional

Estuche Portátil*
Parte #: 26016

INSTRUCCIONES DE FUNCIONAMIENTO

Antes de Usarse:

1. Retire todo el material de empaque.
2. Retire el pegamento y las etiquetas del aparato.
3. Limpie muy bien la Canastilla y la Cacerola con agua caliente, esponja y detergente suave o, en el lavavajillas, sólo en la parte superior.
4. Limpie con un trapo húmedo el interior y exterior del aparato. No lo sumerja en agua.
5. La Freidora de Aire Brio 3Q viene con una carcasa especial debajo para un almacenamiento del acorde fácil y conveniente. Usted verá una parte que sobresale, el resto del acorde se enrollara cuidadosamente en la caja.

Nota: Este aparato cocina usando aire caliente. NO llene la canastilla con aceite.

Preparación para el Uso:

1. Coloque el aparato en una superficie plana, estable y resistente al calor.
2. Coloque la Cacerola y la Canastilla en la NuWave Brio 3Q Freidora Digital de Aire
3. Conecte el aparato en un enchufe de pared estándar.

Nota: No cubra u obstruya el respiradero localizado en la parte de arriba de NuWave Brio 3Q Freidora Digital de Aire para que tenga buena ventilación y no afecte los resultados de cocción.



Función Encendido/Apagado:

Presione el botón "On/Off" una vez para encender el aparato. El panel de control mostrará "0" indicando que aún no se ha seleccionado tiempo o temperatura y el aparato está encendido. Presione "On/Off" otra vez para apagar la unidad.



Función de Rápido:

Presione el botón "Pause/Clear" una vez para empezar a cocinar, se mostrará un ":15" así como un ícono de ventilador y la NuWave Brio 3Q Freidora Digital de Aire comenzará la cuenta regresiva. Está automáticamente en 360°F por 15 minutos.



Función de Inicio Pausa/Borrar:

- Para interrumpir el proceso de cocción o precalentamiento, pulse una vez el botón "Pause/Clear". "5" aparecerá en la pantalla indicando una cuenta atrás de 5 minutos. Si no se toman otras acciones durante esta cuenta regresiva, "0" aparecerá en la pantalla. Para reanudar una vez que la unidad ha estado en pausa, presione el botón "Start" una vez.
- Para borrar el tiempo de cocción programado y la temperatura, pulse el botón "Pause/Clear" una segunda vez. Esto borrará las funciones actuales de cocción. "0" aparecerá en la pantalla.

INSTRUCCIONES DE FUNCIONAMIENTO (Continuación)

MENU

Selección de Menú:

Presione "Menu". La luz roja sobre las papas a la francesa se iluminará y se mostrará un "360". Presione "Start" para comenzar a cocinar. La cuenta regresiva iniciará. Para seleccionar un platillo diferente, presione "Menu" para elegirlo antes de presionar "Start". Vea la siguiente tabla de selecciones pre-programadas de "Menu".

Para salir de la selección de Menu, presione "Menu" otra vez hasta que la luz roja sobre los tipos de platillos ya no está iluminada. Si utiliza la función de Precalentar, presione "Pre-Heat" antes de "Menu" para asegurarse de usar la temperatura adecuada. Todas las selecciones de menú están automáticamente a 1300 watts.

Tipo de Platillo	Tiempo (minutos)	Temp	Cantidad (onzas)
 Papas a la Francesa (Caseras y gruesas)	25	360°F	12
 Papas a la Francesa Congeladas (corte medio)	15	400°F	16
 Nuggets de Pollo	8	400°F	8
 Carne (½" ribeye)	12	360°F	8 oz each
 Aves (Pechuga de pollo)	12	360°F	8 oz each
 Pescado (Palitos de Pescado Congelados)	8	400°F	8

PRE-HEAT

Función de Precalentar:

La función de Precalentar asegura que la NuWave Brio 3Q Freidora Digital de Aire alcance la temperatura deseada antes de que comience a cocinar sus alimentos. La función Precalentar es la opción perfecta para alimentos que requieren una textura más crujiente, como botanas congeladas, papas a la francesa o alitas de pollo.

Presione el botón de "Pre-Heat". La pantalla de control mostrará "Pre-Heat". Pulse las flechas por encima de los iconos de temperatura y el tiempo antes de pulsar "Pause/Clear". La temperatura predeterminada se establece en 360°F. Si es necesario, usted puede ajustar manualmente la temperatura y el tiempo de cocción pulsando las flechas arriba y abajo usando el icono de tiempo y temperatura.

Una vez que la NuWave Brio 3Q Freidora Digital de Aire alcanza la temperatura elegida, el panel de control mostrará "Ready" y NuWave Brio 3Q Freidora Digital de Aire sonará una vez. NuWave Brio 3Q Freidora Digital de Aire comenzará una cuenta regresiva de 5 minutos y el número "5" parpadeará. Se mantendrá a esta temperatura por hasta 5 minutos o hasta que se retire la Canastilla.

Una vez que los alimentos se hayan colocado en la Canastilla, insértela de regreso en su lugar. Así comenzará la cuenta regresiva del tiempo elegido.

INSTRUCCIONES DE FUNCIONAMIENTO (Continuación)

PRE-
HEAT

Nota: Si se retira la Canastilla en cualquier momento de la etapa de precalentamiento, la NuWave Brio 3Q Freidora Digital de Aire automáticamente se pausará y comenzará una cuenta de 5 minutos hasta que se vuelva a colocar la Canastilla.

Si usted cocinara otra porción de comida casi inmediatamente después de usar la NuWave Brio 3Q Freidora Digital de Aire no necesitará usar la función de Precalentar ya que la NuWave Brio 3Q Freidora Digital de Aire ya estará caliente. Si usted desea cocinar su comida más tiempo, solamente coloque la Cacerola y la Canastilla dentro del aparato y continúe cocinando por incrementos de 2-3 minutos hasta alcanzar la consistencia deseada.



Ajuste de Temperatura:

La NuWave Brio 3Q Freidora Digital de Aire está programada para cocinar automáticamente a 360°F. Para establecer una temperatura diferente, presione las flechas arriba y abajo del ícono Temp. la pantalla otra mostrará “360°F” y “Temp” parpadeará. Para ajustar la temperatura, continúe presionando las flechas de arriba o abajo. Se puede ajustar la temperatura en incrementos de 5 grados desde 100°F hasta 400°F.

Para ajustar rápidamente la temperatura en incrementos grandes, solamente **mantenga presionada** la flecha (de arriba o abajo) para ajustar la temperatura en incrementos de 10°. Se puede cambiar la temperatura en cualquier momento del proceso. Presione las flechas arriba y abajo del ícono Temp. La temperatura programada se mostrará y “Temp” parpadeará. Presione la flecha de arriba o la de abajo hasta alcanzar la temperatura deseada.

Una vez elegida la temperatura, la NuWave Brio 3Q Freidora Digital de Aire automáticamente se ajustará a la nueva temperatura y la pantalla mostrará el tiempo restante. Si no se selecciona una nueva temperatura en 3 segundos, la NuWave Brio 3Q Freidora Digital de Aire mostrará nuevamente el tiempo restante.



Ajuste de Tiempo:

La NuWave Brio 3Q Freidora Digital de Aire está programada para cocinar automáticamente por 15 minutos. Para establecer un tiempo diferente, presione las flechas arriba y abajo del ícono Time. La pantalla mostrará “15” y “Time” parpadeará. Para ajustar el tiempo continúe presionando las flechas “Up” (arriba) o “Down” (abajo). Se puede ajustar el tiempo en incrementos de 1 minuto.

Para ajustar rápidamente el tiempo en incrementos grandes, solamente mantenga **presionada** la flecha “Up” o “Down” (arriba o abajo) para ajustar en incrementos de 10 minutos, seguido por incrementos de 20 minutos, seguido por incrementos de 30 minutos. El tiempo mínimo a seleccionar es de 1 minuto y el máximo dependerá de la temperatura seleccionada.

- Para 100°F – 345°F, el tiempo máximo es de 99:59 horas
- Para 350°F – 400°F, el tiempo máximo es de 1 hora

Se puede cambiar el tiempo en cualquier momento del proceso. Presione las flechas arriba y abajo del ícono Time y el tiempo restante se mostrará. Presione la flecha de arriba o la de abajo hasta alcanzar el tiempo deseado. Una vez elegido el tiempo, la pantalla mostrará el nuevo tiempo restante

INSTRUCCIONES DE FUNCIONAMIENTO (Continuación)

Nota: Una vez que el tiempo alcance 1 minuto, la pantalla comenzará a mostrar el tiempo restante en segundos (59, 58, etc.).

MENU

Selección de Menú:

Presione "Menu". La luz roja sobre las papas a la francesa se iluminará y se mostrará un "360". Presione "Start" para comenzar a cocinar. La cuenta regresiva iniciará. Para seleccionar un platillo diferente, presione "Menu" para elegirlo antes de presionar "Start". Vea la siguiente tabla de selecciones pre-programadas de "Menu".

Para salir de la selección de Menu, presione "Menu" otra vez hasta que la luz roja sobre los tipos de platillos ya no está iluminada. Si utiliza la función de Precalentar, presione "Pre-Heat" antes de "Menu" para asegurarse de usar la temperatura adecuada. Todas las selecciones de menú están automáticamente a 1300 watts.

Para Mejor Resultados

Una vez seleccionado el tiempo y la temperatura y estar listo para colocar los alimentos en la Freidora de Aire NuWave Brio: Jale la Cacerola y la Canastilla de la Freidora de Aire NuWave Brio. (Fig. 1)

Nota: No llene más de 4/5. Deslice la cacerola de regreso a la Freidora de Aire NuWave Brio. No utilice la Cacerola sin la Canastilla adentro. (Fig. 2)

Nota: No toque la Cacerola inmediatamente después de cocinar, ya que puede estar muy caliente. Sólo tómla del mango.

Agitar los Alimentos:

Algunos alimentos necesitan agitarse a la mitad de la cocción. Para agitar los alimentos de la Canastilla tome el mango, jale la Cacerola fuera del aparato y mueva. Una vez que se haya realizado adecuadamente, deslice la Cacerola y la Canastilla dentro de la Freidora de Aire NuWave Brio. (Fig.3)

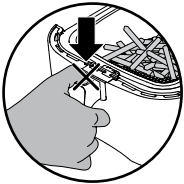

NO PRESIONE EL BOTÓN DE DESMONTAJE MIENTRAS AGITA.

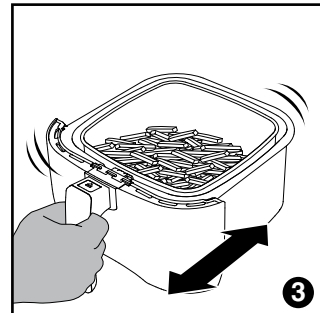
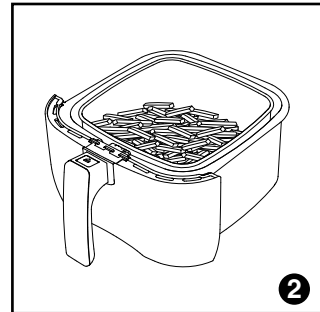
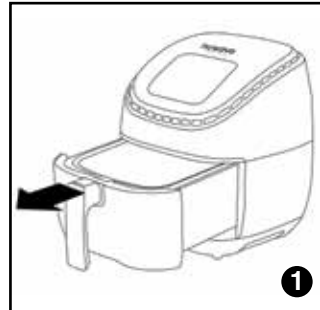

INSTRUCCIONES DE FUNCIONAMIENTO (Continuación)

Como Usar La Cacerola De La Parrilla:

1. Saque la cesta de la bandeja de la base y colóquela en una superficie plana.
2. Levante la tapa de seguridad y presione el botón de desmontaje.
3. Levante la cesta de el sartén y reemplácela por la bandeja de la parrilla
4. Para quitar la bandeja de la parrilla o cesto de la cacerola de la bandeja base, abra la tapa de seguridad y presione el botón de desmontaje.

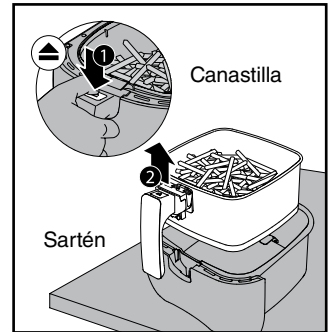

Esto reducirá el peso adicional de la bandeja base y hará que sea más fácil para verter alimentos mas pequeños, como las papas fritas.



CUIDADO & MANTENIMIENTO

Limpieza:

Limpie el aparato después de cada uso o entre una gran cantidad de lotes. La canasta de la freidora y la bandeja de la base tienen un revestimiento antiadherente con una cesta desmontable de acero inoxidable. No utilice utensilios de metal o abrasivos fuertes al limpiar, ya que esto puede dañar el revestimiento.

- Desconecte el aparato y asegúrese de que se enfríe completamente.

Note: Retire la Cacerola y la Canastilla y colóquelas sobre una superficie resistente al calor para ayudar a que se enfríen más rápido.

- Utilice un trapo húmedo para limpiar la parte exterior del aparato.
- Limpie la Canastilla y los componentes internos con una esponja y detergente suaves y agua caliente.

Note: Si coloca la Cacerola o la Canastilla en el lavavajillas, utilice sólo la parte superior.

Consejo: Si queda comida pegada en la Cacerola o la Canastilla, agregue un poco de agua caliente y deje remojar para limpiarla más fácilmente.

- Limpie el interior del aparato con una esponja suave y agua caliente.
- Limpie los componentes para calentar con un cepillo para quitar cualquier rastro de comida pegada.

Almacenamiento:

- Desconecte el aparato y déjelo enfriar completamente.
- Asegúrese de que todas las partes estén limpias y secas.
- La Freidora de Aire Brio 3Q viene con una carcasa especial debajo para un almacenaje del acorde fácil y conveniente. Usted verá una parte que sobresale, el resto del acorde se enrollará cuidadosamente en la caja.

IMPORTANTE - No sumerja la unidad en agua ni intente lavarla en el lavavajillas. La superficie exterior puede limpiarse cuidadosamente con un trapo húmedo o esponja. Asegurese de que la unidad se haya enfriado completamente antes de limpiarla.



USO & CUIDADO DE LOS ACCESORIOS

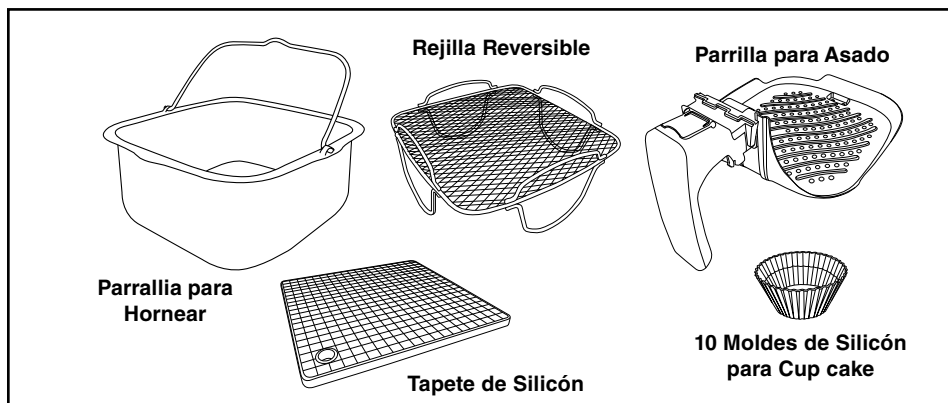

Uso & Cuidado:

Antes de usarse, lave con jabón suave y agua, o en un lavavajillas, sólo en la parte superior. Nunca deberá limpiarse con abrasivos o cortado con ningún objeto filoso.

- No utilice fibra metálica o algún otro objeto filoso que pueda rayar o dañar el silicón.
- No coloque los productos de silicón en la rejilla más alta o el asador de un horno convencional.
- No intente cortar alimentos que estén dentro de los accesorios. Cualquier mal uso de los accesorios invalidará la garantía.

Nuestro material de silicón puede resistir temperaturas de hasta 500°F, pero tenga en cuenta que esas temperaturas están por encima de las recomendadas para este producto. Los daños causados por este tipo de uso no estarán cubiertos por la garantía.

- Limpie la Parrilla para Asado, la Parrilla para Hornear y la Rejilla Reversible con agua caliente jabonosa y una esponja no abrasiva, o en el lavavajillas antes del primer uso y después de cada uso. Enjuague completamente. No remoje los accesorios por largos periodos de tiempo.
- No talle los accesorios con fibras metálicas, soluciones limpiadoras para horno, ni utilice limpiadores o materiales abrasivos, ya que podrían rayarse. Los raspones menores o la decoloración no impactará en el funcionamiento de las partes.
- Guarde en un lugar seco y fresco.

Nota: Los accesorios son opcionales

GUÍA DE SOLUCIÓN DE PROBLEMAS

PROBLEMA	POSIBLE CAUSAS(S)	SOLUCION
La Freidora de Aire NuWave Brio no funciona.	<p>El aparato no está conectado.</p> <p>No se presionó el botón ON/OFF.</p> <p>No está la Canastilla en la Freidora NuWave Brio.</p>	<p>Conecte la clavija en un contacto apropiado. Presione el botón ON/OFF después de seleccionar los ajustes. Coloque la Canastilla en la Freidora NuWave Brio.</p>
Los ingredientes en la Canastilla no están lo suficientemente fritos.	<p>Se usaron demasiados ingredientes.</p> <p>La temperatura es muy baja.</p> <p>El tiempo es muy corto.</p>	<p>Quite algunos ingredientes de la Canastilla. Las porciones pequeñas se fríen mejor. Fría a una temperatura más alta. Programe la Freidora por más tiempo.</p>
La comida no se fríe uniformemente.	<p>Algunos ingredientes necesitan agitarse a la mitad del tiempo de cocción.</p>	<p>Los ingredientes que se encuentran en la parte superior necesitan ser agitados a la mitad del tiempo de preparación.</p>
Las botanas fritas no salen crujientes de la Freidora de Aire NuWave Brio.	<p>Se utilizó un tipo de botana que está diseñada para prepararse en una freidora tradicional.</p>	<p>Utilice botanas hechas para hornos tradicionales o cepille las botanas con aceite de oliva para que queden crujientes.</p>
No se puede deslizar la Canastilla en el aparato.	<p>La Canastilla está muy llena.</p> <p>La Canastilla no está colocada correctamente en la Cacerola.</p>	<p>No llene la Canastilla más de un 4/5 partes. Presione la Canastilla hacia abajo en la Cacerola hasta que escuche un click.</p>
Sale humo blanco del aparato.	<p>Está friendo alimentos grasosos.</p> <p>La Cacerola tiene residuos grasosos de los usos anteriores.</p>	<p>Cuando se preparen alimentos grasosos en la Freidora de Aire Brio, pueden surgir grandes cantidades de humo y adherirse a la Cacerola. La grasa producirá humo blanco y la Cacerola puede calentarse más de lo habitual. Esto no afectará el efecto final. Asegúrese de limpiar la cacerola correctamente después de cada uso.</p>

GUÍA DE SOLUCIÓN DE PROBLEMAS (Continuación)

Las papas a la francesa no se fríen uniformemente en la Freidora de Aire NuWave Brio.	Las papas no se remojaron bien antes de freírlas. No uso el tipo de papa adecuada.	Remoje las papas en un recipiente por al menos 30 minutos, sáquelas y séquelas con una toalla de papel. Utilice papas frescas y asegúrese de que estén firmes durante su cocción.
Las papas a la francesa no salen crujientes de la Freidora de Aire NuWave Brio.	Lo crujiente de las papas depende de la cantidad de aceite y agua en ellas.	Asegúrese de secar bien las papas antes de ponerles aceite. Corte las papas más pequeñas o agregue un poco más de aceite para que queden más crujientes.
<p>Si la unidad necesita ser reemplazada o devuelta al fabricante, contacte a nuestro Departamento de Servicio al Cliente al 1-877-689-2838 o escriba a help@nuwavenow.com</p>		

Contacte a Servicio al Cliente si ocurre alguno de estos errores

Código Error	E1	E2	E3
	Un problema en el Sensor	Corto Circuito en el Sensor	Sobrecalentamiento

GARANTÍA LIMITADA

NuWave Brio® 3Q Freidora de Aire Digital

LAS GARANTÍAS DEL FABRICANTE

La Brio 3Q Freidora de Aire Digital, incluyendo la Base de Poder, Sartén, Canastilla, y La Malla de la Canastilla deben estar libres de defectos del fabricante. Todos los componentes eléctricos están garantizados por un año a partir de la fecha de compra, bajo uso doméstico normal y cuando son operados de acuerdo con las instrucciones escritas del fabricante.

El fabricante proporcionará las piezas y mano de obra necesarias para reparar cualquier parte de la Freidora de Aire Digital en el Departamento de Servicio de NuWave, LLC. Después de la expiración de la garantía, el costo de la mano de obra y las piezas serán responsabilidad del propietario.

LA GARANTÍA NO CUBRE

La Garantía Limitada se invalida si la reparación es hecha por un distribuidor no autorizado o si la placa del número de serie es retirada o maltratada. El deterioro normal del acabado, por uso o exposición, no está cubierto por esta Garantía. Esta Garantía Limitada tampoco cubre fallas, daños o desempeño inadecuado por accidentes, desastres naturales (como relámpagos), variaciones en la potencia eléctrica, alteraciones, abuso, mal uso, ambientes corrosivos, instalación inadecuada, o falla en la operación de acuerdo con las instrucciones escritas por el Fabricante, uso no normal o comercial.

GARANTÍA LIMITADA (Continuación)

PARA OBTENER EL SERVICIO

El propietario tendrá la obligación y responsabilidad de: Pagar por todos los servicios y partes no cubiertas por la garantía; Prepagar el envío al y desde el Departamento de Servicio para cualquier parte o sistema devuelto bajo esta garantía; Empacar cuidadosamente el producto utilizando el material de relleno adecuado para prevenir cualquier daño durante el tránsito. El empaque original es ideal para este propósito. Incluya en el empaque el nombre del propietario, dirección, teléfono durante el día, una descripción detallada del problema y su "número RGA" (**Llame al 1-877-689-2838o escriba a help@nuwavenow.com**) para obtener el RGA (Número de Autorización de Devolución del Producto). Proporcione el modelo del producto, el número de serie y comprobante de la fecha de compra (una copia del recibo) cuando reclame su garantía.

OBLIGACIONES DEL FABRICANTE

Las obligaciones del Fabricante bajo esta Garantía Limitada están restringidas a la reparación o reemplazo de cualquier parte cubierta por esta Garantía Limitada que sea encontrada defectuosa, una vez revisada, bajo un uso normal. La Garantía Limitada aplica únicamente en los Estados Unidos y sólo para el comprador original en los canales de distribución autorizados por el fabricante.

LA GARANTÍA LIMITADA NO PUEDE SER ALTERADA, CAMBIADA O EXTENDIDA EXCEPTO POR UN INSTRUMENTO POR ESCRITO REALIZADO POR EL FABRICANTE. LA SOLUCIÓN DE REPARACIÓN O REEMPLAZO INCLUIDA EN ESTA GARANTÍA ES EXCLUSIVA. EN NINGÚN CASO EL FABRICANTE SERÁ RESPONSABLE POR DAÑOS CONSECUENTES O INCIDENTALS A CUALQUIER PERSONA. SEA O NO OCASIONADO POR LA NEGLIGENCIA DEL FABRICANTE, INCLUYENDO SIN LIMITACION DAÑOS POR PÉRDIDA POR USO, COSTO DE REEMPLAZO, DAÑO A LA PROPIEDAD, U OTRAS PÉRDIDAS MONETARIAS.

Algunos estados no permiten la exclusión o limitación de daños relevantes o fortuitos, así que la exclusión mencionada podría no aplicar. Esta Garantía Limitada proporciona derechos legales específicos y podrían haber otros derechos que varíen entre estado y estado. EXCEPTO POR LO QUE YA SE EXPRESÓ DE FORMA DIFERENTE, EL FABRICANTE NO GARANTIZA EXPRESA O IMPLÍCITAMENTE POR LEY U OTRAS, INCLUYENDO SIN LIMITACIONES, LAS GARANTÍAS IMPLÍCITAS DE COMERCIALIZACIÓN Y EJERCICIO PARA UN PROPÓSITO PARTICULAR A CUALQUIER OTRA PERSONA. LEA EL MANUAL DEL USUARIO. SI TUVIERA ALGUNA DUDA SOBRE EL FUNCIONAMIENTO O LA GARANTÍA DEL PRODUCTO, CONTACTE A NUWAVE, LLC.

LEA EL MANUAL DEL PROPIETARIO: Si aún tiene alguna pregunta sobre el funcionamiento o la garantía del producto, comuníquese con NuWave, LLC al: 1-877-689-2838 o por correo electrónico help@nuwavenow.com.

**Brio® 6-Qt
Digital Air Fryer**



**Nutri-Pot® 6-Qt
Digital Pressure Cooker**



**NuWave Primo™
Combo Grill**



**NuWave PIC® Gold
Precision Induction Cooktop**



**BruHub®
Coffee Maker**



**Moxie® High-Performance
Vacuum Blender**



**Duralon® Healthy Ceramic
Non-Stick Cookware**

nuwave®

— LIVE WELL FOR LESS —

www.NuWaveNow.com

FOR HOUSEHOLD USE ONLY

Model: 36011,36012, 120V, 60Hz, 1300 Watts

For patent information please go to: www.nuwarennow.com/legal/patent

Designed & Developed in USA by:

NuWave, LLC

1795 N. Butterfield Road
Libertyville, IL 60048, U.S.A.

Customer Service:

help@nuwarennow.com • www.nuwarennow.com

Made in China

©2019 NuWave, LLC • All Rights Reserved.

Item No. BM 36011A

Rev. 09-OG

01-17-2019