

nuwave®

BRAVO® XL SMART OVEN

**Air Fryer and Oven
with Temperature Probe**

Owner's Manual

**Model: 20801 - 20803
Rev.02**



Questions or Concerns?

**Toll Free: 1-877-689-2838 • help@nuwavenow.com
(Mon-Fri 7:30am-4:30pm CST)**

PRODUCT REGISTRATION

Thank you for purchasing the NuWave Bravo XL Oven
and welcome to the NuWave Family!



WELCOME

Congratulations on getting your new Bravo XL! We are incredibly excited for you and want to make sure you get the most out of your new oven and your cooking experience.

That's what this manual is all about. In it, we have provided detailed operating and care instructions covering every aspect of your new oven to make sure it fully meets your needs.

NuWave prides itself on the relationships it builds with its customers - a relationship that only begins with the purchase. So, if you have any questions, comments, or concerns, please don't hesitate to contact Customer Service. We'll take good care of you!

We're glad you're with us, and we know that you will be, too!

The NuWave Team

Connect with Us!



#nuwavenow

Visit nuwavenow.com to see other great products and accessories.

REGISTER YOUR PURCHASE

1. Scan the QR code or visit www.nuwavenow.com/QR to Register.
2. Have your proof of purchase! you will need it to register your product.
3. Locate your serial and model numbers to have ready.

TECHNICAL SPECIFICATIONS

Voltage: 120V, 60Hz
Wattage: 1800 watts

Note: You can locate the model and serial numbers, as well as the QR code, on the label on the back of the unit.

CUSTOMER SERVICE

Phone: **1-877-689-2838**
(Mon-Fri 7:30am - 4:30pm CST)
Email: help@nuwavenow.com

TABLE OF CONTENTS

| | |
|---|--------------|
| Safeguards & Information | 4-5 |
| Power-Supply Cords..... | 5 |
| Parts & Accessories | 6 |
| Ordering Parts..... | 6 |
| Assembly Guide | 7 |
| Before First Use..... | 7 |
| Control Panel | 8-14 |
| Functions(LED Display)..... | 8 |
| Operating Buttons..... | 9 |
| Operating Buttons Functions..... | 10-13 |
| 2-Button Combination Functions..... | 13-14 |
| Temperature and Measure Charts | 15 |
| Using The Menu Functions | 16-21 |
| Air Fry..... | 16 |
| Bake..... | 16 |
| Broil..... | 17 |
| Dehydrate..... | 17 |
| Frozen..... | 18 |
| Grill..... | 18 |
| Pizza..... | 19 |
| Reheat..... | 19 |
| Roast..... | 20 |
| Slow Roast..... | 20 |
| Toast..... | 21 |
| Yogurt..... | 21 |
| Care & Maintenance | 22-23 |
| Replacing the Lightbulb..... | 23 |
| Troubleshooting | 24-25 |
| Limited Warranty | 26-27 |

Para la versión en español de este manual, visita www.nuwavenow.com

SAFEGUARDS & INFORMATION

ALWAYS KEEP THIS MANUAL HANDY FOR FUTURE REFERENCE.

READ ALL INSTRUCTIONS and WARNINGS Only use the appliance as intended and always follow basic safety precautions. Avoid any misuse of the Bravo XL that can void your warranty and create the risk of serious injury.

1. Read all instructions.
2. Ensure the Bravo XL and all parts are clean and dry before each use.
3. **Do not** touch hot surfaces. The appliance's surfaces may be hot during and after use. Use handles.
4. Discard the protective plastic covering the power plug before use.
5. **Do not** let the electrical cord touch hot surfaces or hang over any edge.
6. **Do not** immerse cord, plug, or appliance in water or other liquid.
7. Close supervision is necessary when any appliance is used near children. This appliance is not intended for use by persons with reduced physical, sensory or mental capabilities, children, or persons with a lack of experience or knowledge, unless supervised or instructed in the use of the appliance by one responsible for their safety.
8. **Do not** operate if the Bravo XL or cord malfunctions or has been damaged in any way. Return the unit to the nearest authorized service facility for examination, repair, or adjustment.
9. Use only on a clean, stable, dry, and level surface.
10. **Do not** use accessories or attachments not recommended by the manufacturer.
11. **DO NOT USE OUTDOORS. FOR INDOOR USE ONLY.**
12. **Do not** place on or near a hot gas or electric burner, or in a heated oven.
13. Unplug the appliance when not in use and allow the appliance to cool completely before cleaning or removing/replacing parts.
14. **Do not** cover or block the intake air vents located in the back and sides of the Bravo XL, as doing so can prevent proper ventilation. There should be at least 5 inches of free space behind, to the sides of, and on top of the Bravo XL.
15. Use aluminum foil to wrap foods that produce oil or juice when operating the Drip/Baking Pan to catch drippings and prevent fire.
16. To prevent fire, do not allow any foil to touch the heating elements.
17. **Do not** alter or modify any part of the Bravo XL or use attachments or accessories not recommended by the manufacturer.
18. It is normal for some smoke to escape the Bravo XL when heating for the first time.
19. If excess smoke is escaping from the air vent during operation, unplug the Bravo XL immediately and contact Nu-Wave Customer Service at **1-877-689-2838** or email help@nuwavenow.com
20. During use, steam may be released from the air outlet vents. Keep your hands and face away from these vents. Be careful of hot steam escaping when opening the Bravo XL.
21. Avoid placing your face near the glass door during use.

22. Never touch the insides of the Bravo XL while it is operating.
 23. Use extreme caution when moving an appliance containing hot oil or other hot liquids.
 24. Never leave the Bravo XL unattended during use.
 25. **Do not** disassemble the Bravo XL.
 26. Allow the Bravo XL to cool before putting in or pulling out items or before cleaning.
 27. Keep this manual handy for future reference.
 28. Always make sure your fingers are clean and dry when pressing the buttons.
7. **Do not** cover the crumb tray or any part of the oven with metal foil. This will cause overheating of the oven.
 8. Turn off the Bravo XL by pressing the **On/Off Button** before unplugging the unit from the wall socket.

Toaster Oven Warnings (UL Standard 1026, Section 71.7):

1. Oversize foods or metal utensils must not be inserted in a toaster oven as they may create a fire or risk of electric shock.
2. A fire may occur if the toaster-oven is covered or touching flammable material, including curtains, draperies, walls, and the like, when in operation. **Do not** store any item on top of the appliance when in operation.
3. **Do not** clean with metal scouring pads. Pieces can break off the pad and touch electrical parts creating a risk of electric shock.
4. Extreme caution should be exercised when using containers constructed of materials other than metal or glass.
5. **Do not** store any materials, other than the manufacturers recommended accessories, in this oven when not in use.
6. **Do not** place any of the following materials in the oven: paper, cardboard, plastic, cloth, wood, flammable materials, sealed containers, and the like.

Power-Supply Cords

A short power-supply cord (or detachable power-supply cord) is provided to reduce the risk of becoming entangled in, or tripping over, a longer cord. Longer detachable power-supply cords or extension cords are available and may be used if care is exercised in their use. If a longer detachable power-supply cord or extension cord is used:

1. The marked electrical rating of the extension cord should be at least as great as the electrical rating of the appliance.
2. The longer cord should be arranged so that it will not drape over any countertop or tabletop where it could be pulled on or tripped over unintentionally.
3. The Bravo XL should be operated on a separate electrical outlet from other operating appliances due to wattage limitations.

SAVE THESE INSTRUCTIONS

WARNING

To reduce the **risk of electric shock**, do not perform any servicing other than that which is contained in these instructions.

To disconnect the Bravo XL, turn it off by pressing the **ON/OFF** button and then remove the plug from the wall outlet.

NEVER use the Bravo XL with loose, damaged, or missing parts.

While cooking, **ALWAYS** use oven mitts and allow accessories to cool before washing.

PARTS & ACCESSORIES

- 1** Base
Part #: BRA10
- 2** Handle
- 3** Digital Display Menu
- 4a** Probe Input Jack
- 4b** Temperature Probe
Part #: BRP4
- 5** START/PAUSE Dial
- 6** Function Buttons
- 7** Pull-Out Crumb Tray
Part #: BRA17
- 8** 2 Heavy-Duty
Cooking Racks
Part #: BRA18
- 9** Enamel Baking Pan
and Enamel Broiler
Rack
Part #: BRA20
- 10** Air Fry Basket
Part #: BRA25
- 11** Light Bulb
Part#: BRP1
- 12** Light Bulb Cover
Part#: BRP2

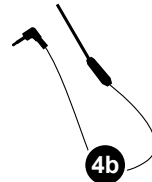
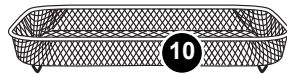
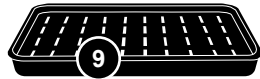
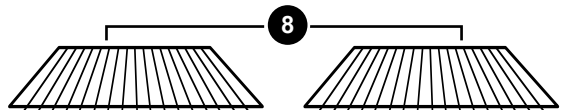
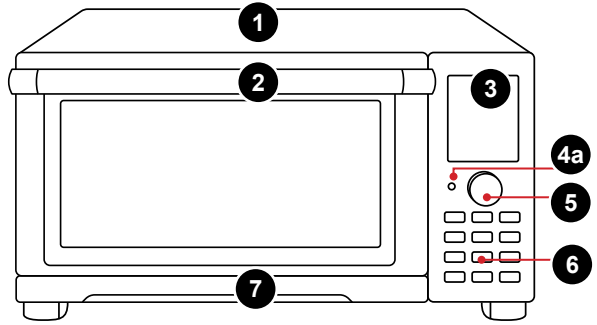

ORDERING PARTS

Over the lifetime of your Bravo XL, you may find yourself needing a new part or accessory, and if you do, NuWave has you covered.

Ordering new parts and accessories is quick and easy. Have ready down the name and number for the part you want, then contact Customer Service. You can do that by:

- Phone at **877-689-2838** (Mon-Fri 7:30am - 4:30pm CST), or
- Email at **help@nuwavenow.com**

You can even order directly online. Just visit **www.nuwavenow.com**

ASSEMBLY GUIDE

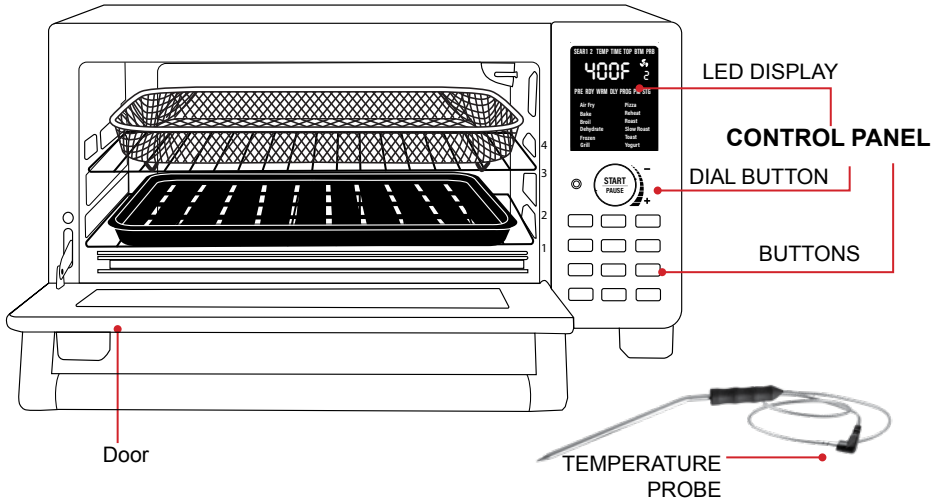

Before First Use

1. Remove and discard any packaging material from the unit.
2. Remove all accessories from their packaging and wash them in warm, soapy water or in the dishwasher, top rack only, except for the Probe. **NEVER** submerge the main unit in water.

While most of the accessories are dishwasher-safe, the Probe is not. Hand washing is recommended. Frequent dishwasher cleaning may lead to premature wear.

1. Place the Bravo on a level, even, and stable heat-resistant surface.
2. Slide the Cooking Rack(s) into Position 1, 2, 3, or 4 of the Bravo.
3. Place Baking Pan with Broiler Rack on Cooking Rack in Position 1.
4. Place the Air Fry Basket above the Baking Pan. We recommend you use the Air Fry Basket with the Baking Pan to optimize cooking results.
5. Place Crumb Tray into position by sliding it into slot at bottom of Oven. To remove, push down slightly and pull out.
6. Plug the appliance into a standard wall socket. The power plug is located in the rear of the unit.

Notes:

Do not cover or block the air vents on the Bravo, as doing so can prevent proper ventilation.

CONTROL PANEL

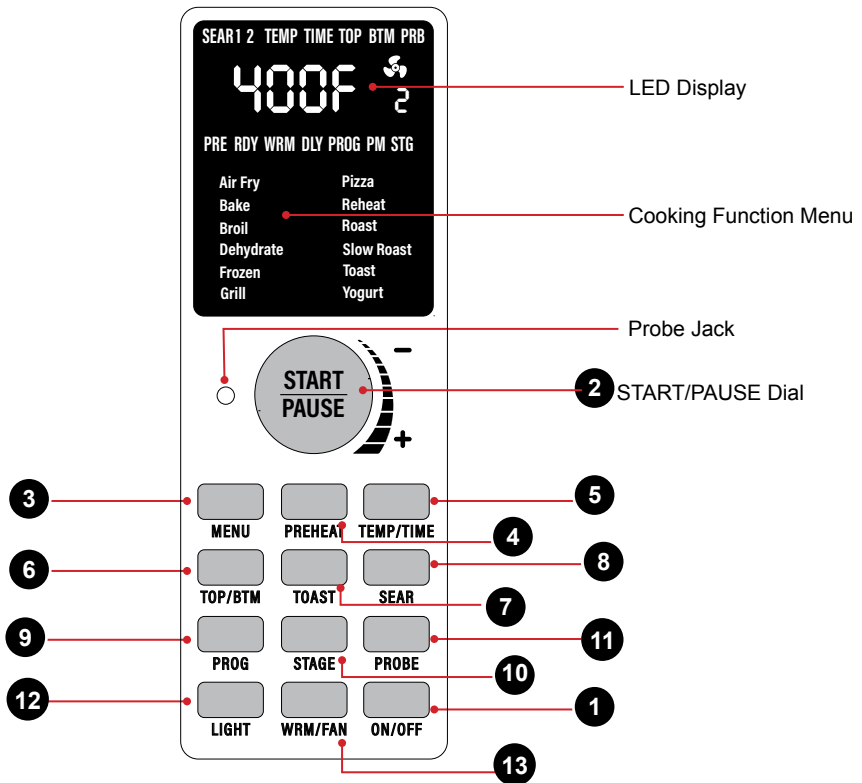

FUNCTIONS (LED DISPLAY)

AIR FRY: Produce foods that are crispy outside and moist and tender inside without actual frying.

BAKE: Evenly bakes cookies, brownies, cakes and more.

BROIL: Cooks your food with 100% top heat.

DEHYDRATE: Preserving fruits, vegetables, herbs, and meats by removing moisture.

FROZEN: Cooks frozen foods.

GRILL: Cooks your food using 50% top heat and 100% bottom heat.

PIZZA: Your pizza gets a crispy crust. You can also use the pizza setting for other dishes like a quiche.

REHEAT: Heat leftovers without over cooking.

ROAST: Cooking it evenly on all sides perfect for vegetables and meats.









SLOW ROAST: It's great for breaking down and tenderizing large pieces of meat like pot roasts or beef stews.

TOAST: Evenly toast bread, bagel, waffles and more.(9 slides of bread)

YOGURT: Make your own homemade yogurt.

CONTROL PANEL OPERATING BUTTONS

-  **ON/OFF**
Turns the Bravo® XL **ON** and **OFF**. This also cancels any cooking function.
-  **START/PAUSE**
Press to begin the cooking process, the fan icon will display and time the “:” will be flashing. Press to pause to stop cooking, no fan icon will be displayed and the “:” will not flash.

By turning the dial will adjust the TEMP/TIME, TOP/BTM. MENU, TOAST, PROG, or FAN.
-  **MENU**
Accesses the 12 cooking functions. by pressing **MENU** multiple times or by Turn **START/PAUSE** to select.
-  **PREHEAT**
Heats to a desired temperature. By default, the preheat temperature is set to 350F.
-  **TEMP/ TIME**
Press this button to change the display between the cooking temperature and time. Turn the **START/PAUSE** dial to change the temperature or time.
-  **TOP/BTM**
Adjusts the power to the top and bottom heating elements. Default is set to 100/100.
-  **TOAST**
Press to get direct access to the Toast menu function.
-  **SEAR**
Sears your food to preserve juices. Default is 450°F for 5 minutes.
-  **PROG**
Access to 100 preprogramed recipes. These are listed on the Quick Start Guide and the back of the recipe book.
There are 50 available slots for user created recipes.
-  **STAGE**
Lets you cook at different temperatures and times throughout the cooking process.
-  **PROBE**
Use the included Digital Probe for perfect results every time.
-  **LIGHT**
Turns the internal light on and off.
-  **WARM/FAN**
Keeps your favorite foods warm after cooking, or adjusts the fan speed with the press of a button.

Note: Refer to OPERATING BUTTONS FUNCTIONS for detail explanation for each button and features.

OPERATING BUTTON FUNCTIONS



ON/OFF

1. Press **ON/OFF** to turn the oven on.
2. While the oven is cooking, press **ON/OFF** to stop cooking and cancel all programmed functions.



START/PAUSE

1. Press **START/PAUSE** to begin cooking.
2. While cooking, press **START/PAUSE** once to pause the oven. Press it again to resume cooking.
3. The **START/PAUSE** dial can be turned to adjust the TEMP/TIME, TOP/BTM. MENU, TOAST, PROG, and FAN settings.
4. When the cooking cycle has completed, the Bravo XL will beep 3 times and display END.

3. Once the Bravo XL reaches the set temperature it will beep and show "RDY" on the display indicating it is time to place your food inside the oven.
4. Once your food is inside the Oven, press **START/PAUSE** to begin cooking. Alternatively, The Bravo will start cooking after 10 seconds regardless if food is placed or not.

NOTE:

- Press **PREHEAT** at any point to cancel the preheat process.
- Consult page 14 for instructions to disable **AUTO PREHEAT**.



MENU

Access 12 cooking functions by pressing **MENU** and turning the **START/PAUSE** dial to select your desired function, then press **START/PAUSE** to make your selection.

NOTE:

- Any function can be added to the Menu selections but will not remain permanent.



TEMP/ TIME

The default setting is 350°F for 15 minutes. Cooking temperature can be adjusted in 5°F increments and time in 1-minute increments. Adjustments can be made for all functions, before and during the cooking process.

1. Turn the **START/PAUSE** dial to adjust the cooking temperature
2. Press **TEMP/TIME** to switch the display from temperature to time. Turn the **START/PAUSE** dial to adjust the cooking time.
3. To change the default temperature, set the new temperature. Press and hold **START/PAUSE** until you hear two beeps Repeat to switch back. The same process works for changing the default time.
4. To change the display time to minutes (mm) and seconds (ss), press and hold **START/PAUSE** while the time is displayed.



PREHEAT

The Bravo XL automatically preheats to the set cooking temperature.

1. Set the cooking temperature and time.
2. Press **START/PAUSE** to begin the cooking cycle and the Bravo XL will begin preheating. The temperature will be flashing while preheating.

OPERATING BUTTONS FUNCTIONS



TOP/BTM

By default, both the top and bottom heaters are set to cook at 100%.

This can be independently adjusted for each set of heaters between 0 and 100%.

1. Press **TOP/BTM**, 100 and TOP will be displayed. Adjust the percentage using the **START/PAUSE** dial.
2. Press **TOP/BTM** again, and BTM and 100 will be displayed. Adjust the percentage using the **START/PAUSE** dial.

NOTE:

- When the temperature is set over 450°F, both the top and bottom heaters will operate while preheating. Once preheated, only the top heaters will operate. This is the only time the top middle heater operates .
- The heating percentages can be adjusted at any point before or during the cooking process.

SEAR 2 occurs at the end of the cooking process.

SEAR 1 2 occurs both at the beginning and end of the cooking process.

SEAR1 & SEAR 2

1. Set the cooking temperature and time.
2. Press **SEAR** until you reach your selected **SEAR** function and adjust the temperature and time if needed.
3. Press **START/PAUSE** to begin the cooking cycle.

SEAR 1 2

1. Set the cooking temperature and time.
2. Press **SEAR** once and adjust the temperature and time if needed. This will be your SEAR 1 setting.
3. Press **SEAR** again for SEAR 1 2 and adjust the temperature and time if needed. This will be your SEAR 2 setting.
4. Press **START/PAUSE** to begin the cooking cycle.

NOTE:

- The default SEAR setting is to cook at 450°F for 5 minutes.
- The temperature can be set up to 500°F and the time can be adjusted up to 30 minutes.
- Adjustments to the temperature and time can be made at any point. If the temperature probe reaches the set temperature before the end of the cooking cycle, SEAR 2 will not occur.
- Utilize the STAGE feature to set the cooking temperature and time after programming the SEAR function.



TOAST

1. Press **TOAST**. 5 will be shown on the display.
2. Turn the **START/PAUSE** dial to select your desired Toast setting and press **START/PAUSE** to begin.
3. Press and hold **TOAST** to begin toasting immediately.

NOTE:

- Consult the chart on page 21 for more information on the 10 Toast settings.



SEAR

SEAR 1 occurs at the start of the cooking process.

OPERATING BUTTONS FUNCTIONS

PROG

PROG

The Bravo XL has 100 pre-programmed recipes which can be found in the Quick Start Guide.

There are also 50 available preset slots for user-created recipes.

To recall the 100 preset recipes.:

1. Press **PROG**. 1 will be shown on the display.
2. Turn the **START/PAUSE** dial to select your desired preset.
3. Press **START/PAUSE** to begin cooking.

To program and save your own recipe:

1. Set the cooking temperature and time.
2. Select any desired cooking functions (Preheat, Sear, Delay, Warm).
3. Press and hold **PROG**, then choose from memory slots 101-150.
4. Press and hold **PROG** until you hear 2 beeps. This will save your program in your selected slot.
5. Press **START/PAUSE** to begin cooking if desired.

NOTE:

- You may save your programmed recipe at any point before, during or after cooking.
- If you want to save your recipe after cooking, follow steps 3 and 4 above.

STAGE

STAGE

there are 5 stages. Defaults, Stage 1 at 350°F for 15 mins, Stages 2-5 at 350°F for 00:00 min.

1. Press **STAGE** and STG 1 will display. Adjust the cooking temperature and time, if needed.

2. Press **STAGE** again for stage 2. Adjust the cooking temperature and time.
3. Press **STAGE** and set for all stages needed for the recipe.
4. Press the **START/PAUSE** to begin the cooking cycle.

NOTE:

- You may add the PROBE function to any stage.
- Other functions such as Preheat and Sear can be added to cooking stages but when doing so, the display will not show the stage number.
- If the time is not set for Stages 2-5, those stages will be skipped.
- The temperature and time can be adjusted for any stage while cooking.
- When using the probe, the Bravo XL will stop cooking when the target temperature has been reached regardless of the remaining stages.

PROBE

PROBE

The digital temperature probe can be inserted into your food to measure its internal temperature as it cooks.

1. Plug the probe into the jack on the Bravo XL control panel, then insert the other end into the thickest part of the food.
2. Set your desired cooking function. Press **PROBE** and hold **PROBE**. The default 165°F set temperature will be displayed.
3. Set the target internal temperature between 50°F and 212°F and press **START/PAUSE** to begin cooking.
4. When the probe's measured temperature reaches the target temperature, the Bravo XL will stop cooking.

CONTROL PANEL 2-BUTTON COMBINATION FUNCTIONS

NOTE:

- Ensure the probe does not touch any bones when inserted.
- Press **PROBE** at any time while cooking to display the current probe temperature.
- Press and hold **PROBE** at any time to view the target temperature.
- The Bravo XL will beep 3 times when the probe temperature is within 10°F of the target temperature. If the set cooking time has ended and the target temperature has not been reached, the Bravo XL will continue to cook until reached.

2 BUTTON FUNCTIONS

| | |
|------------------|---------------------|
| Set the Clock | PREHEAT + TEMP/TIME |
| Mute/Unmute | SEAR + STAGE |
| Change F° to C° | TEMP/TIME + SEAR |
| Independent Warm | WRM/FAN + TOP/BTM |
| Delay | PROG + TOP/BTM |
| Lock | PROG + STAGE |
| Auto Preheat Off | PROG + PREHEAT |
| Slow Cook | PROG + PROBE |



LIGHT

Turns the internal light on and off.



WARM/FAN

By default, this function keeps the Bravo XL at 140°F for 1 hour.

1. Set your desired cooking temperature and time
2. Press **WRM/FAN** and set the temperature between 140°F and 200°F and set the time between 1 minute and 3 hours as needed
3. Press **START/PAUSE** to begin cooking.
4. Once your set cooking cycle has ended, the Bravo XL will beep once and begin the programmed Warm cycle.

Independent Warm Function is used without cooking.

1. Press both the WRM/FAN and TOP/BTM .
2. The warming cycle will begin automatically.

CLOCK

1. Press **PREHEAT + TEMP/TIME**, 12:00 will be displayed.
2. The clock is set for AM time by default. To switch to PM, turn the **START/PAUSE** dial counterclockwise.

Press both buttons at once

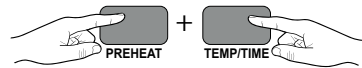

NOTE:

- The set time can be viewed any time by pressing **PREHEAT + TEMP/TIME**.
- When the time is displayed, the time can be changed.
- The clock does not save when the oven is unplugged.

MUTE/UNMUTE

1. Press **STAGE + SEAR** to mute the beep sounds. Repeat to reinstate the beeps.

Press both buttons at once

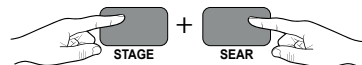

CONTROL PANEL

2-BUTTON COMBINATION FUNCTIONS

CHANGE BETWEEN FAHRENHEIT TO CELSIUS

1. Press **SEAR + TEMP/TIME**. Repeat to switch back.

Press both buttons at once

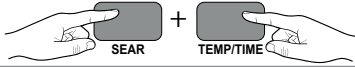

To turn off **AUTO PREHEAT**

1. Press and hold **PROG + PREHEAT** until you hear 2 beeps. Repeat to switch back.

Press both buttons at once

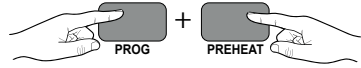

NOTE:

- Disabling Auto Preheat also disables it for any applicable Menu functions
- When disabled, Auto Preheat will remain disabled even after the Bravo XL is unplugged.
- You may still manually enable Preheat before cooking by pressing **PREHEAT** before pressing **START/PAUSE**.

INDEPENDENT WARM

1. Press both the **WRM/FAN + TOP/BTM**
2. The warming cycle will begin automatically.

Press both buttons at once

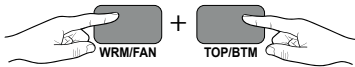

DELAY

1. Set the cooking temperature and time.
2. Press **PROG + TOP/BTM** and set the amount of time to delay the cooking process.
3. Press **START/PAUSE** to begin the delayed cooking cycle

Press both buttons at once

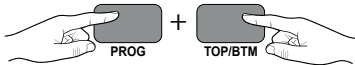

NOTE:

When in delay mode, the temperature and time cannot be adjusted.

SLOW COOK

1. Set your desired cooking function, adjusting the temperature as needed.
2. Set the probe target temperature.
3. Press **PROG + PROBE** to enable the slow cook function. The default 1 hour time will be displayed.
4. Make any adjustments to the cooking temperature and time.
5. Press **START/PAUSE** to begin cooking.

Press both buttons at once

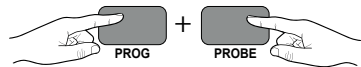

NOTE:

1. When the Slow Cook function is enabled, the cooking temperature will be no less than 25°F above the target probe temperature.

LOCK

1. Press **PROG + STAGE** to stop the function of the Bravo. While in lock mode, your Bravo's buttons will not respond to any action until the unit is unlocked

Press both buttons at once

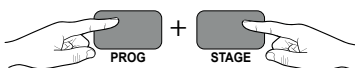

TEMPERATURE CHARTS

Probe Temperatures

| Meats | Oven Temp. | Rare | Med Rare | Med | Med Well | Well |
|---|------------|------|----------|------|----------|------|
| Chicken, breast Turkey, breast Duck, breast | 360 | | | | | 165* |
| Chicken, whole Turkey, whole Duck, whole | 360 | | | | | 165* |
| Chicken, thigh Turkey, thigh Duck, thigh | 360 | | | | | 165* |
| Steak 1" thick (25mm) | 450 | 125 | 135 | 145* | 150* | 160* |
| Burgers ½ lb (227g) | 450 | 125 | 135 | 145* | 155* | 160* |
| Roast Beef (bone-in) Roast Beef (boneless) | 350 | 125 | 135 | 145* | 150* | 160* |
| Roast Lamb (bone-in)Lamb (boneless) | 350 | 125 | 135 | 145* | 150* | 160* |
| Pork (bone-in) Pork (boneless) | 350 | | | 145* | 150* | 160* |
| Salmon, Tuna, Halibut, Swordfish | 450 | | | 145* | 150* | 160* |
| Fish Steaks 1" thick (25mm) | 450 | | | 145* | 150* | 160* |
| Sausage | 450 | | | | | 160* |

Note: Times may vary depending on cooking preference. Consuming raw or undercooked meats, poultry, or seafood may increase your risk of food borne illness. *To reduce the risk, cook your food to USDA-safe temperatures.

Cooking Time

| Cooking Temperature | Selectable Cooking Time |
|---------------------|-------------------------|
| 50°F–275°F | 00:01–99:59 |
| 280°F–350°F | 00:01–24:00 |
| 355°F–400°F | 00:01–04:00 |
| 405°F–450°F | 00:01–01:00 |
| 455°F–500°F | 00:01–00:30 |

Measurement Chart

| | | |
|----------------|----------------------|---------------|
| Teaspoon = t | Fahrenheit = °F | Minute = min |
| Tablespoon = T | Celsius = °C | Second = sec |
| Cup = c | Fluid Ounces = fl oz | Inch = in. |
| Ounce = oz | Liter = L | Dozen = doz |
| Pound = lb(s) | Milliliter = ml | Hour = hr |
| Quart = qt | Package = pkg. | Gram = g |
| Pint = pt | Gallon = gal | Kilogram = kg |

USING THE MENU FUNCTIONS

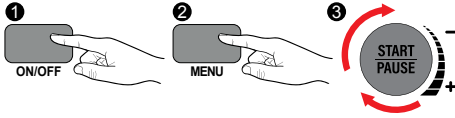

- 1 Press the **ON/OFF** button to turn the unit on.
- 2 Press the **MENU** button.
- 3 Turn the Dial to make a Function selection

AIR FRY

Automatic Preheats

- Default Temp: 360°F
- Default Time: 15 min.
- Heat Source: Top/Bottom (100/100 percent)
- Rack Position: 1 and 3

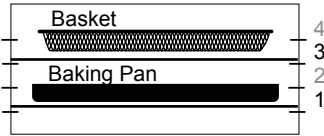

1. To change the temperature or time press **TEMP/TIME** to display the temperature or press again to see the time. To adjust the temperature or time, turn the **START/PAUSE** dial.
2. Press the **START/PAUSE** to begin the cooking cycle.

(Optional: if not press **PREHEAT** to cancel and may need to add more cooking time)

BAKE

Automatic Preheats

- Default Temp: 350°F
- Default Time: 25 min.
- Heat Source: Top/Bottom (100/100 percent)
- Will have a preheat
- Rack Position: 1, 2, or 3

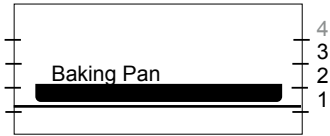

1. To change the temperature or time press **TEMP/TIME** to display the temperature or press again to see the time. To adjust the temperature or time, turn the **START/PAUSE** dial.
2. Press the **START/PAUSE** to begin the cooking cycle.
3. The oven will be preheating by default. When it's finished, insert your food.

OPTIONAL

- Flip food or rotate pans halfway through the cooking cycle.
- **PROBE**: is to be inserted in the food to cook to a set internal temperature.
- If not press **PREHEAT** to cancel and may need to add more cooking time.

USING THE MENU FUNCTIONS

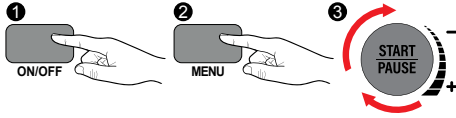

- 1 Press the **ON/OFF** button to turn the unit on.
- 2 Press the **MENU** button.
- 3 Turn the Dial to make a Function selection

BROIL

Automatic Preheats

- Default Temp: 500°F
- Default Time: 5 min.
- Heat Source: Top (100 percent)
- Rack Position: 2 or 3

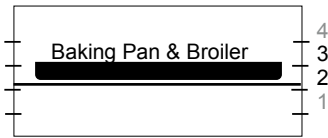

1. To change the temperature or time press **TEMP/TIME** to display the temperature or press again to see the time. To adjust the temperature or time, turn the **START/PAUSE** dial.
2. Press the **START/PAUSE** to begin the cooking cycle.
3. The oven will be preheating by default. When it's finished, insert your food.

OPTIONAL

- Flip food or rotate pans halfway through the cooking cycle.
- **PROBE**: is to be inserted in the food to cook to a set internal temperature.
- If not press **PREHEAT** to cancel and may need to add more cooking time

DEHYDRATE

- Default Temp: 100°F
- Default Time: 2 hours
- Heat Source: Top/Bottom (100/100 percent)
- Rack Position: Any

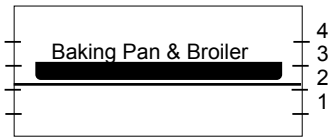

1. To change the temperature or time press **TEMP/TIME** to display the temperature or press again to see the time. To adjust the temperature or time, turn the **START/PAUSE** dial.
2. Press the **START/PAUSE** to begin the cooking cycle.
3. The oven will be preheating by default. When it's finished, insert your food.

OPTIONAL

- Flip food or rotate pans halfway through the cooking cycle.
- If not press **PREHEAT** to cancel and may need to add more cooking time.

USING THE MENU FUNCTIONS

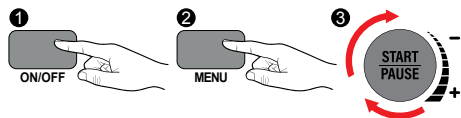

- 1 Press the **ON/OFF** button to turn the unit on.
- 2 Press the **MENU** button.
- 3 Turn the Dial to make a Function selection

FROZEN

Automatic Preheats

- Default Temp: 375°F
- Default Time: 30 min.
- Heat Source: Top/Bottom (100/100 percent)
- Rack Position: Any

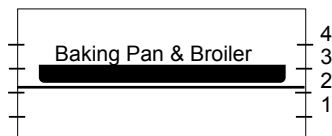

1. To change the temperature or time press **TEMP/TIME** to display the temperature or press again to see the time. To adjust the temperature or time, turn the **START/PAUSE** dial.
2. Press the **START/PAUSE** to begin the cooking cycle.
3. The oven will be preheating by default. When it's finished, insert your food.

OPTIONAL

- Flip food or rotate pans halfway through the cooking cycle.
- If not press **PREHEAT** to cancel and may need to add more cooking time.

GRILL

Automatic Preheats

- Default Temp: 425°F
- Default Time: 15 min.
- Heat Source: Top/Bottom (50/100 percent)
- Will have a preheat to 450°F
- Rack Position: 1

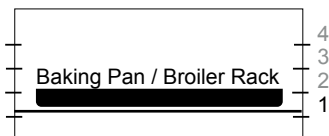

1. To change the temperature or time press **TEMP/TIME** to display the temperature or press again to see the time. To adjust the temperature or time, turn the **START/PAUSE** dial.
2. Press the **START/PAUSE** to begin the cooking cycle.
3. The oven will be preheating by default. When it's finished, insert your food.

OPTIONAL

- Flip food or rotate pans halfway through the cooking cycle.
- **PROBE**: is to be inserted in the food to cook to a set internal temperature.
- If not press **PREHEAT** to cancel and may need to add more cooking time.

USING THE MENU FUNCTIONS

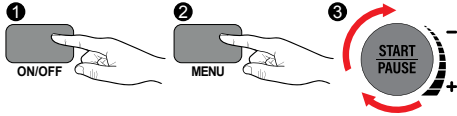

- 1 Press the **ON/OFF** button to turn the unit on.
- 2 Press the **MENU** button.
- 3 Turn the Dial to make a Function selection

PIZZA

Automatic Preheats

- Default Temp: 400°F
- Default Time: 15 min.
- Heat Source: Top/Bottom (30/100 percent)
- Will have a preheat
- Rack Position: 1 or 2. (For crispier results use position 1.)

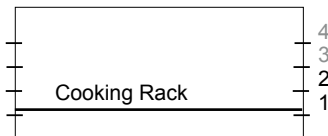

1. To change the temperature or time press **TEMP/TIME** to display the temperature or press again to see the time. To adjust the temperature or time, turn the **START/PAUSE** dial.
2. Press the **START/PAUSE** to begin the cooking cycle.
3. The oven will be preheating by default. When it's finished, insert your food.

OPTIONAL

- Rotate your pizza halfway through the cooking cycle.
- If not press **PREHEAT** to cancel and may need to add more cooking time.

REHEAT

- Default Temp: 350°F
- Default Time: 10 min.
- Heat Source: Top/Bottom (100/100 percent)
- Rack Position: Any

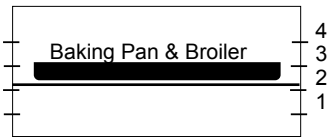

1. To change the temperature or time press **TEMP/TIME** to display the temperature or press again to see the time. To adjust the temperature or time, turn the **START/PAUSE** dial.
2. Press the **START/PAUSE** to begin the cooking cycle.
3. The oven will be preheating by default. When it's finished, insert your food.
4. Reheat leftovers to 165F internal temperature.

OPTIONAL

- Flip food or rotate pans halfway through the cooking cycle.
- If not press **PREHEAT** to cancel and may need to add more cooking time.

USING THE MENU FUNCTIONS

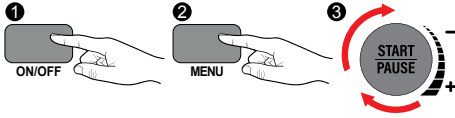

- 1 Press the **ON/OFF** button to turn the unit on.
- 2 Press the **MENU** button.
- 3 Turn the Dial to make a Function selection

ROAST

Automatic Preheats

- Default Temp: 375°F
- Default Time: 30 min.
- Heat Source: Top/Bottom (100/100 percent)
- Will have a preheat
- Rack Position: 1

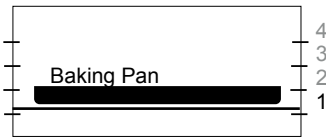

1. To change the temperature or time press **TEMP/TIME** to display the temperature or press again to see the time. To adjust the temperature or time, turn the **START/PAUSE** dial.
2. Press the **START/PAUSE** to begin the cooking cycle.
3. The oven will be preheating by default. When it's finished, insert your food.

OPTIONAL

- Flip food or rotate pans halfway through the cooking cycle.
- **PROBE**: is to be inserted in the food to cook to a set internal temperature.
- If not press **PREHEAT** to cancel and may need to add more cooking time.

SLOW ROAST

- Default Temp: 165°F
- Default Time: 1 hour
- Probe: 165°F
- Heat Source: Top/Bottom (100/100 percent)
- Rack Position: 1, 2, or 3

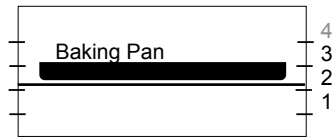

1. To change the temperature or time press **TEMP/TIME** to display the temperature or press again to see the time. To adjust the temperature or time, turn the **START/PAUSE** dial.
2. Press the **START/PAUSE** to begin the cooking cycle.
3. The oven will be preheating by default. When it's finished, insert your food.

OPTIONAL

- Flip food or rotate pans halfway through the cooking cycle.
- **PROBE**: is to be inserted in the food to cook to a set internal temperature.
- If not press **PREHEAT** to cancel and may need to add more cooking time.

USING THE MENU FUNCTIONS

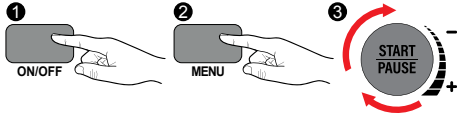

- 1 Press the **ON/OFF** button to turn the unit on.
- 2 Press the **MENU** button.
- 3 Turn the Dial to make a Function selection

TOAST

Automatic Preheats

- Default Temp: 425°F
- Default Time: 5 min.
- Heat Source: Top/Bottom (100/100 percent)
- Rack Position: 3

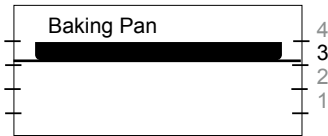

1. Press **TOAST**. The LED display will show "TOAST" and "5." To adjust the toasting level between "1" and "10," turn the **START/PAUSE** dial to the left for lighter toast, right for darker toast. Toasting levels in minutes and seconds are as follows at 425°F:
 - 1 – 03:00 • 6 – 05:30
 - 2 – 03:30 • 7 – 06:00
 - 3 – 04:00 • 8 – 06:30
 - 4 – 04:30 • 9 – 07:00
 - 5 – 05:00 • 10 – 07:30
2. To change the temperature or time press **TEMP/TIME** to display the temperature or press again to see the time. To adjust the temperature or time, turn the **START/PAUSE** dial.
3. Press the **START/PAUSE** to begin the cooking cycle.
4. The oven will be preheating by default. When it's finished, insert your food
5. When the toasting level, or the time and temperature, is selected, place toast into oven and press **START/PAUSE** button. When finished, the LED display will show "End" and will beep three (3) times.

YOGURT

- Default Temp: 275°F
- Default Time: 8 hours
- Probe: 185°F
- Heat Source: Top/Bottom (100/100 percent)
- Rack Position: 1

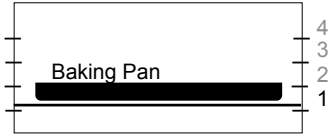

1. To change the temperature or time press **TEMP/TIME** to display the temperature or press again to see the time. To adjust the temperature or time, turn the **START/PAUSE** dial.
2. Insert the Probe into the milk and secure it with the probe clip. Probe's default is 185°F.
3. Place the bowl into the Bravo and hit **START/PAUSE**.
4. When the milk reaches 175°F: Bravo will sound two beep warning as it approaches 185°F.
5. Let it cool to 110°F.
6. To speed this process, open the Bravo's door or remove the bowl and place it in an ice water bath (leave the probe connected).
7. When the temp reaches 110°F, the Bravo will beep for 10 minutes, or until deactivated.
8. Place the bowl back into the Bravo and close the door and press **START/PAUSE**. The unit will maintain to 110°F for up 8 hours.

CARE & MAINTENANCE

BEFORE FIRST USE:

Wash all removable parts¹ in warm, soapy water or in the dishwasher, top rack only.

1. Remove all the packaging materials.
2. Remove the glue and labels on the appliance.
3. Clean the Cooking Racks, Baking Pan, Broiler Rack, Air Fry Basket and Crumb Tray thoroughly with hot water, a nonabrasive sponge, and mild dish detergent, or in the dishwasher, top rack only.
4. Wipe the insides and outside of the Bravo with a damp dishcloth or wet cloth and dry thoroughly.

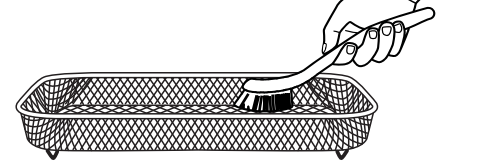
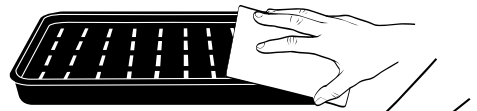
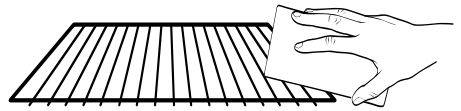
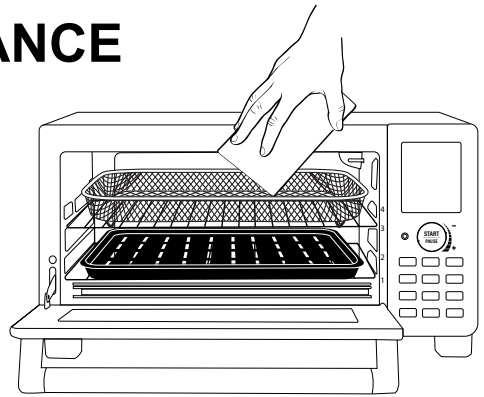

CLEAN AFTER EACH USE:

1. Allow the Bravo to cool completely before cleaning.
2. Always unplug the Bravo from the electrical outlet. NEVER clean the unit while it is plugged in.
3. Never use harsh abrasive or corrosive product cleaners, as they may damage the finish or oven surface. Wipe the exterior with a clean, damp cloth and dry thoroughly.
4. Apply the cleaning agent directly to a cloth towel, not directly to the unit, before cleaning.
5. To clean interior, use a damp cloth, mild liquid soap, and a clean cloth towel.
6. Never use steel wool pads, etc., on interior or exterior of the Bravo.
7. Once cooled, wipe the Stone with a clean damp towel then rinse in a sink with cool water and dry completely. **WARNING:** NEVER submerge or rinse a hot Pizza Stone in water. The hot Stone may crack and break underwater, causing injury.
8. When the glass window is completely cool, spray glass cleaner on a clean cloth towel. Clean both inside and outside of window. Use a damp cloth to rinse the window then dry completely with a clean dry towel.
9. To remove crumbs, slide out the Crumb Tray and discard crumbs. Wipe clean and replace. Crumb Tray should be emptied and cleaned after each use. Never operate the oven without the Crumb Tray in place.
10. To remove baked-on grease, soak Baking Pan, Broiler Rack, Air Fry Basket, Cooking Racks, and Crumb Tray, in hot, soapy water. Dry thoroughly. Never operate the oven without the Crumb Tray in place.

CARE & MAINTENANCE

Storage

- Unplug the Bravo and let unit cool down completely.
- Make sure that all parts are cleaned and dry.
- Never wrap the cord around the Bravo.

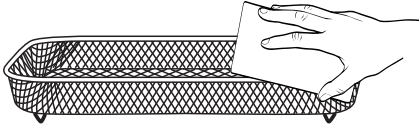

IMPORTANT - Do not immerse the Bravo in water or attempt to cycle through dishwasher. The outer surface may be cleaned by wiping carefully with a damp dishcloth or sponge. Make sure unit has cooled completely prior to cleaning.

REPLACING THE LIGHT BULB

Replacing the Light Bulb

1. Unscrew the light bulb cover turning counter-clockwise (turning to left).
2. Then unscrew the light bulb turning counter-clockwise (turning to left).
3. With the replacement bulb, screw turning clockwise (turning to the right) until tightened.
4. Then screw in the light bulb cover clockwise (turning to the right).

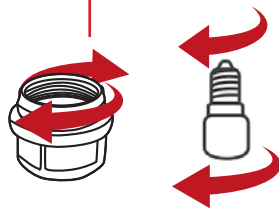
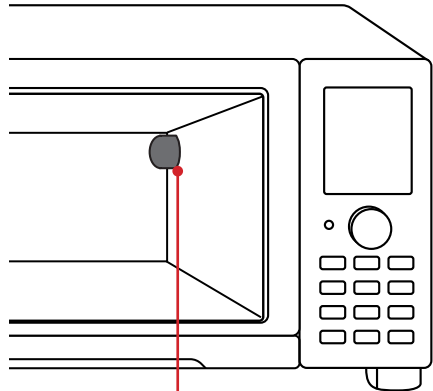

TROUBLESHOOTING GUIDE

The Bravo XL is engineered with an automatic shut-off feature to prevent overheating during use. If the Bravo XL shuts off to cool itself down, an odor may be detected. Unplug the Bravo XL and wait for it to completely cool down. To prevent the Bravo XL from overheating, do not cook foods at higher temperatures or for longer times than recommended.

The Bravo XL Does Not Work

The Bravo XL may not be plugged-in or turned on.

Insert the plug into an appropriate grounded power socket. Press **Power**. If the Bravo XL is still not working, contact Customer Service.

The Bravo XL Door Will Not Close Completely

The food item you are trying to cook is too large, or the Oven Racks or accessories are not properly set in place.

Decrease the size or amount of food being cooked. Make sure the Racks and Pans are properly placed and pushed to the back of the Bravo XL.

The Food is Fried Unevenly

The food you are cooking needs to be shaken or flipped halfway through the process.

Halfway through cooking, open the Oven and shake or flip your food.

The Crumb Tray Does Not Fit Properly in the Bravo XL

The Crumb Tray may not be correctly placed into the slot, or something may be blocking it.

Remove the Crumb Tray and clean away any food items that may have accumulated in the back of the Bravo XL.

White Smoke is Coming Out of the Bravo XL

You are cooking greasy foods, or the Cooking Rack, Chrome Mesh Rack and/or Grill/Griddle may be carrying greasy residue from previous uses.

Clean the Cooking Rack, Chrome Mesh Rack, Grill/Griddle and Crumb Tray regularly between uses.

The LED Display is Blank

The Bravo XL may have overheated and then shut down to cool off, or some required action was not taken and the Oven shut down. Finally, the Control Panel itself may not be working correctly.

Unplug the Bravo XL and allow it to completely cool. Plug it in and see if it is working. If the screen remains blank, contact Customer Service.

The Bravo XL is Not Heating

The Bravo XL may be unplugged. It may have also overheated or the heating elements may not be working.

Make sure the Bravo XL is plugged in and has completely cooled. Start a cooking cycle and see if the unit comes up to the correct temperature. If the Bravo XL still fails to heat up, contact Customer Service.

For further assistance, please contact NuWave's Customer Service Department at 1-877-689-2838 (Mon–Fri 7:30am–4:30pm CST), or at help@nuwavenow.com.

LIMITED WARRANTY

THE MANUFACTURER WARRANTS

NuWave, LLC warrants that Bravo XL will be free from manufacturer defects for 1 year from the date of purchase, under normal household use, and when operated in accordance with the Manufacturer's written instructions. The Limited Warranty covers the Original Purchaser only. The Manufacturer will provide the necessary parts and labor to repair the product at the NuWave LLC Service Department. After the expiration of the warranty, the cost of the parts and labor will be the responsibility of the owner.

THE WARRANTY DOES NOT COVER

The Limited Warranty is voided if repairs are made by an unauthorized dealer, or the serial number data plate is removed or defaced. Normal deterioration of finish due to use or exposure is not covered by this Warranty. This Limited Warranty does not cover failure, damages, or inadequate performance due to accident, acts of God (such as lightning), fluctuations in electric power, alterations, abuse, misuse, misapplications, corrosive-type atmospheres, improper installation, failure to operate in accordance with the Manufacturer's written instructions, abnormal use, commercial or rental uses, or resold units. NuWave LLC reserves the right to void the Limited Warranty, where allowable by law, for products purchased from an unauthorized dealer.

TO OBTAIN SERVICE

The owner shall have the obligation and responsibility to pay for all services and parts not covered by the warranty; prepay the freight to and from Service Department for any part or system returned under this warranty; and carefully package the product using adequate padding material to prevent damage in transit. The original container is ideal for this purpose. Include in the package the owner's name, address, daytime telephone number, a detailed description of the problem, and your Return Goods Authorization (RGA) number. Call 1-877-689-2838 or email help@nuwavenow.com to obtain the RGA number. Provide the cooking system model & serial number and proof of date of purchase (a copy of the receipt) when making claims under this warranty.

MANUFACTURER'S OBLIGATION

The Manufacturer's obligation under this Limited Warranty is limited, to the extent allowable by law, to repairing or replacing any part covered by this Limited Warranty which upon examination is found to be defective under normal use. The Limited Warranty is applicable only within the continental United States and only to the original purchaser of the manufacturer's authorized channels of distribution.

THE LIMITED WARRANTY MAY NOT BE ALTERED, VARIED OR EXTENDED EXCEPT BY A WRITTEN INSTRUMENT EXECUTED BY THE MANUFACTURER. THE REMEDY OF REPAIR OR REPLACEMENT AS PROVIDED UNDER THIS LIMITED WARRANTY IS EXCLUSIVE. IN NO EVENT SHALL THE MANUFACTURER BE LIABLE FOR ANY CONSEQUENTIAL OR INCIDENTAL DAMAGES TO ANY PERSON, WHETHER OR NOT OCCASIONED BY NEGLIGENCE OF THE MANUFACTURER, INCLUDING WITHOUT LIMITATION, DAMAGES FOR LOSS OF USE, COSTS OF SUBSTITUTION, PROPERTY DAMAGE, OR OTHER MONEY LOSS.

Some states do not allow the exclusion or limitation of incidental or consequential damages, so the above limitation exclusions may not apply. This Limited Warranty gives specific legal rights, and there may also be other rights which vary from state to state. **EXCEPT AS OTHERWISE EXPRESSLY PROVIDED ABOVE, THE MANUFACTURER MAKES NO WARRANTIES EXPRESSED OR IMPLIED ARISING BY LAW OR OTHERWISE, INCLUDING WITHOUT LIMITATION, THE IMPLIED WARRANTIES OF MERCHANTABILITY AND FITNESS FOR A PARTICULAR PURPOSE TO ANY OTHER PERSON. READ YOUR OWNER'S MANUAL. IF YOU STILL HAVE ANY QUESTIONS ABOUT OPERATION OR WARRANTY OF THE PRODUCT, PLEASE CONTACT NUWAVE LLC.**

DISPUTE RESOLUTION PROCEDURE

For disputes relating to use of the website or use or purchase of a NuWave product or service (collectively "Disputes"), you agree to first contact NuWave LLC at (877) 689-2838, or legal@nuwavenow.com. If we cannot resolve your dispute informally, any and all disputes shall be submitted to final and binding arbitration. You may start the arbitration process by submitting in writing a demand to the American Arbitration Association ("AAA") and sending a copy to NuWave. NuWave will pay all filing costs. A single arbitrator of the AAA will conduct the arbitration in a location convenient to you or by

LIMITED WARRANTY

phone. The arbitrator's award will be binding and may be entered as a judgment in a court of competent jurisdiction. The arbitration will be conducted in accordance with the provisions of AAA's Commercial Arbitration Rules and Mediation Procedures in effect at the time of submission of your demand for arbitration. See https://www.adr.org/sites/default/files/CommercialRules_Web.pdf. Except as may be required by law as determined by an arbitrator, no party or arbitrator may disclose the existence, content, or results of any arbitration hereunder without prior written consent of both parties.

- A. **WAIVER OF RIGHT TO SUE.** By agreeing to arbitration, you understand that, to the maximum extent permitted by law, you are agreeing to waive your right to file suit in any court, to a court hearing, a judge trial, or a jury trial.
- B. **CLASS ACTION WAIVER.** To the maximum extent permitted by law, you expressly agree to refrain from bringing or joining any claims in any representative or class-wide capacity, including but not limited to, bringing or joining any claims in any class action or class-wide arbitration.
- C. **OPT OUT PROCEDURE.** To request to opt out of arbitration you must contact NuWave LLC at 1-877-689-2838 (Mon–Fri 7:30am–4:30pm CST), or email help@nuwavenow.com. You will have 30 days from the date of product delivery to opt out of arbitration with respect to any dispute arising out of or relating to use or purchase of any NuWave product. If more than 30 days have passed, you are not eligible to opt out of arbitration and will have waived your right to sue or participate in a class action with respect to the dispute arising out of your purchase or use of a NuWave product. For any dispute arising out of your use of NuWave's website, you have 30 days from the date you provided information to the website to opt out of arbitration. If more than 30 days have passed, you are not eligible to opt out of arbitration and you will have waived your right to sue and participate in a class action with respect to the dispute arising out of your use of NuWave's website.
- D. **SOME MATTERS ARE NOT SUBJECT TO ARBITRATION.** Notwithstanding the foregoing, the following shall not be subject to arbitration and may be adjudicated only in the state and federal courts of Illinois: (i) any dispute, controversy, or claim relating to or contesting the validity of our intellectual property rights and proprietary rights, including without limitation, patents, trademarks, service marks, copyrights, or trade secrets; (ii) an action by a party for temporary, preliminary, or permanent injunctive relief, whether prohibitive or mandatory, or other provisional relief; or (iii) interactions with governmental and regulatory authorities. You expressly agree to refrain from bringing or joining any claims in any representative or class-wide capacity, including but not limited to, bringing or joining any claims in any class action or any class-wide arbitration.

STATE OF CALIFORNIA PROPOSITION 65

WARNING

This product can expose you to chemicals including Cadmium, which is known to the State of California to cause cancer, birth defects, and other reproductive harm.

For more information go to: www.P65Warnings.ca.gov.

ADVERTENCIA

Este producto puede exponerle a químicos, incluido el Cadmio, el cual es conocido en el Estado de California por causar cáncer y también defectos de nacimiento u otros daños reproductivos.

Para más información, vaya a www.P65Warnings.ca.gov

READ YOUR OWNER'S MANUAL

If you still have any questions about operation or warranty of this product, please contact NuWave LLC at 1-877-689-2838 (Mon–Fri 7:30am–4:30pm CST), or email help@nuwavenow.com.

nuwave®

BRAVO® XL SMART OVEN

Air Fryer and Oven with Temperature Probe

nuwavenow.com

FOR HOUSEHOLD USE ONLY

120VAC, 60Hz, 1800 Watts

Model: 20801 - 20803

Rev. 2

Para la versión en español de este manual,
visita www.nuwavenow.com.

For patent information please go to:
www.nuwavenow.com/legal/patent

Designed & Developed in USA
NuWave LLC
560 Bunker Ct.
Vernon Hills, IL 60061, U.S.A.

Tel: 1-877-689-2838
Mon - Fri 7:30 am to 4:30 pm (CST)

Email: help@nuwavenow.com

Made in China

©2022 NuWave LLC • All Rights Reserved.

Item No: BM20801

Rev.2-V6-CB

03-28-23