



CT - CLAMP USER MANUAL

CONTENT

About CT CLAMP 01

Model Selection 01

Working Scenario 02

Installation Guidance 04

Setting 08

Troubleshooting 12

1. About CT CLAMP

CT CLAMP is available with Advice Smart MINI series AC EV Charger for home use. When the load of household appliances increase, CT controller can adjust the charging current dynamically to avoid the overloading. In solar system, users can choose it powered by available solar electricity or Grid.

2. Model Selection

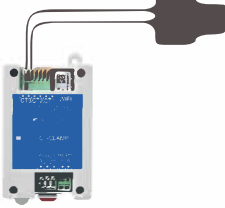
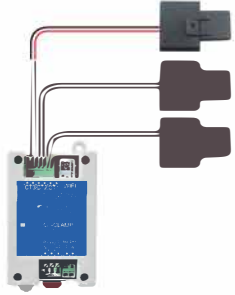
Model	OR CLAMP022-1PH-79	OR CLAMP022-3PH-79
Picture		
Phase	Single phase	Three phase
Number of Current Transformers	1	3
Input Voltage	AC 220V	
Working Frequency	45 - 65 HZ	
System Consumption	Standby: 3W, working: 10W (full function state)	
Display and Buttons	LED/button	
Wireless Connection	Bluetooth, WiFi (2.4GHz only)	
Protocol Connection	OCPP1.6J	
Application	Bluetooth control and configure to Internet	
Working Temperature	-40°C ~ +65°C	
Working Humidity	5%~95% (non-condensing)	
Elevation up to	≤4000M	
Size	92*54*32mm (L*W*H, host only)	
Net Weight	80±5g	

3. Working Scenario

CT CLAMP has two operating modes, one is normal mode and the other is solar mode.

3.1 Working principle of normal mode

- 1 Phase System with CT CLAMP: M51-CT-03-1P

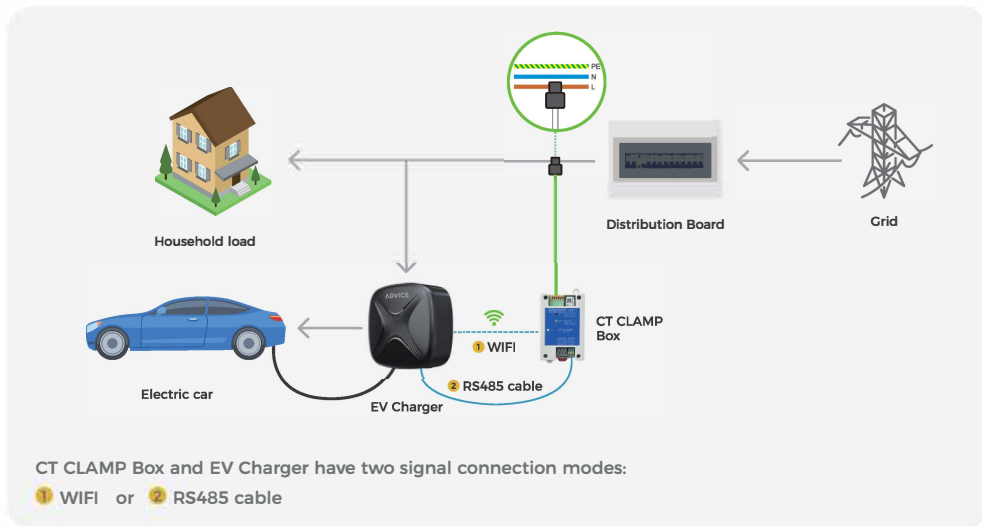

- 3 Phase System with CT CLAMP: M51-CT-03-3P

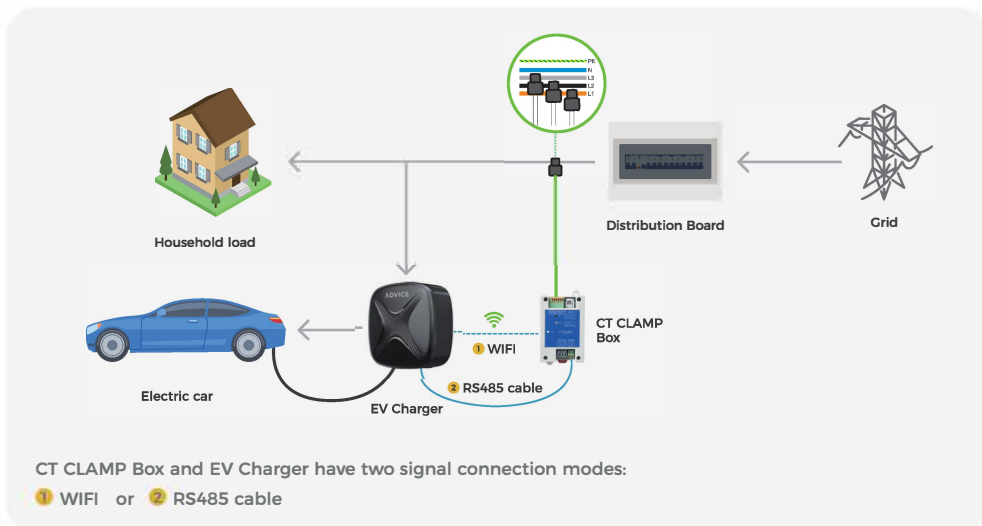

3.2 Working principle of solar mode

In this mode, when there is over 7A residual current transferred from solar system to Grid, Teison Smartmini wallbox will start to work. In the opposite scenario, the charger will stop charging.

Boost mode means that the charger will work with max current powered by both solar electricity and Grid.

- 1 Phase System with CT CLAMP: M51-CT-03-1P

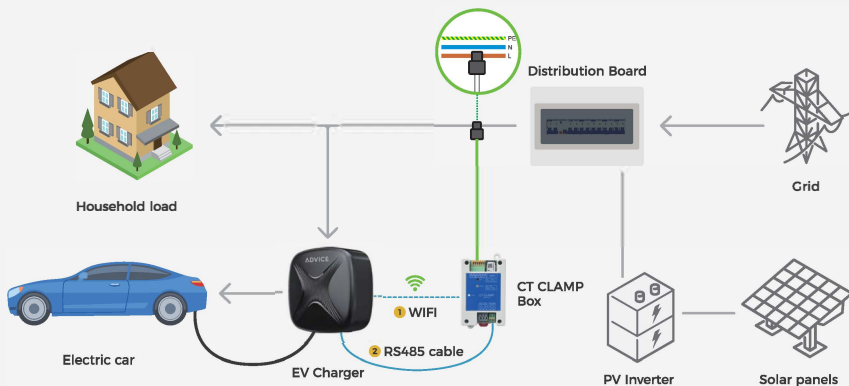

CT CLAMP Box and EV Charger have two signal connection modes:

- ① WIFI or ② RS485 cable

- 3 Phase System with CT CLAMP: M51-CT-03-3P

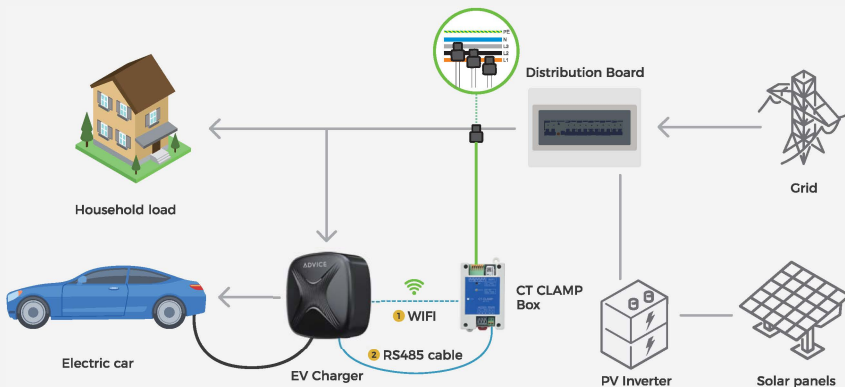

CT CLAMP Box and EV Charger have two signal connection modes:

- ① WIFI or ② RS485 cable

4. Installation Guidance

4.1 Installation method

- CT installation of single phase CT CLAMP Box (M51-CT-03-1P)

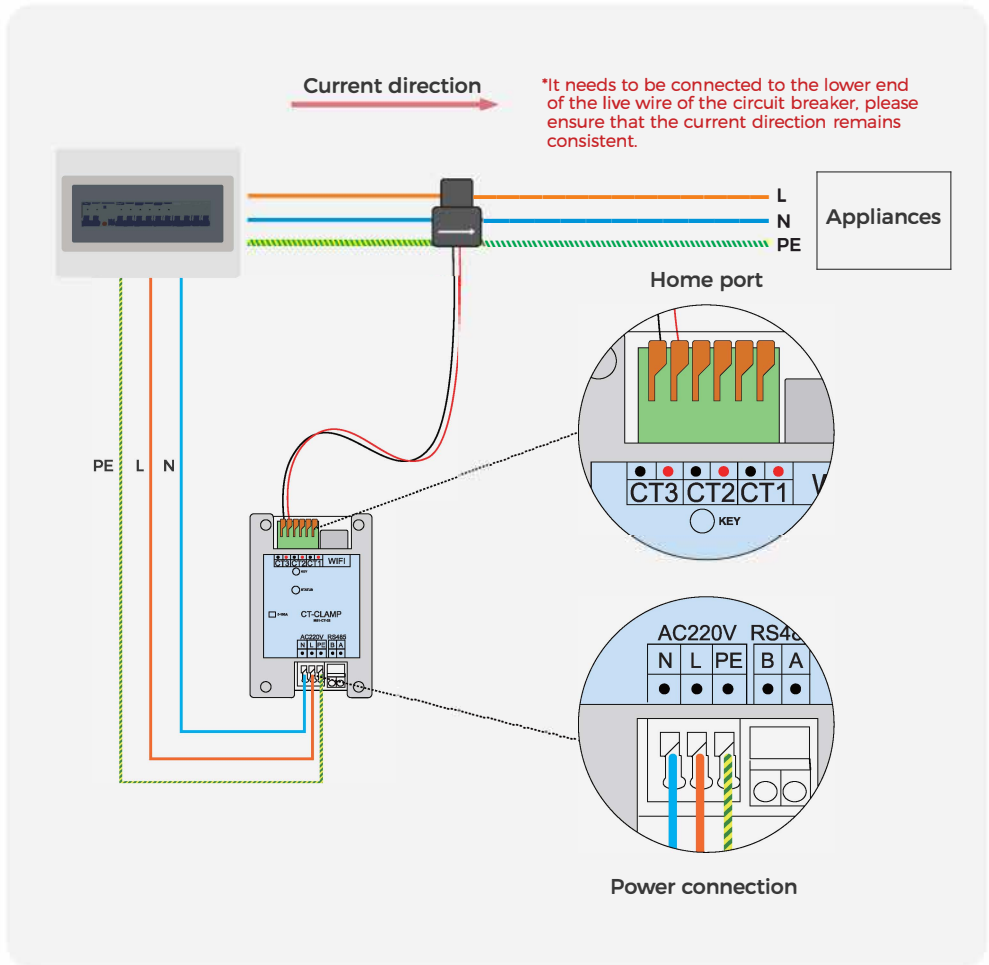

• CT installation of three phase CT CLAMP Box (M51-CT-03-3P)

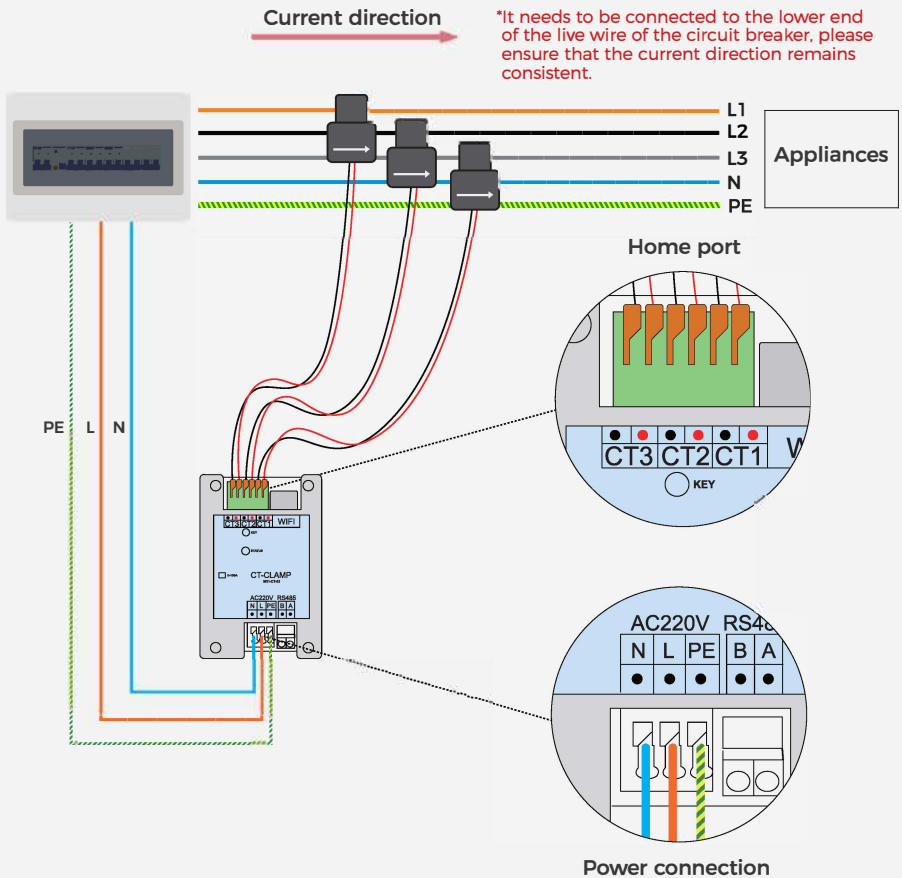

4.2. Communication connection method

- Option 1: RS485 Cable connection

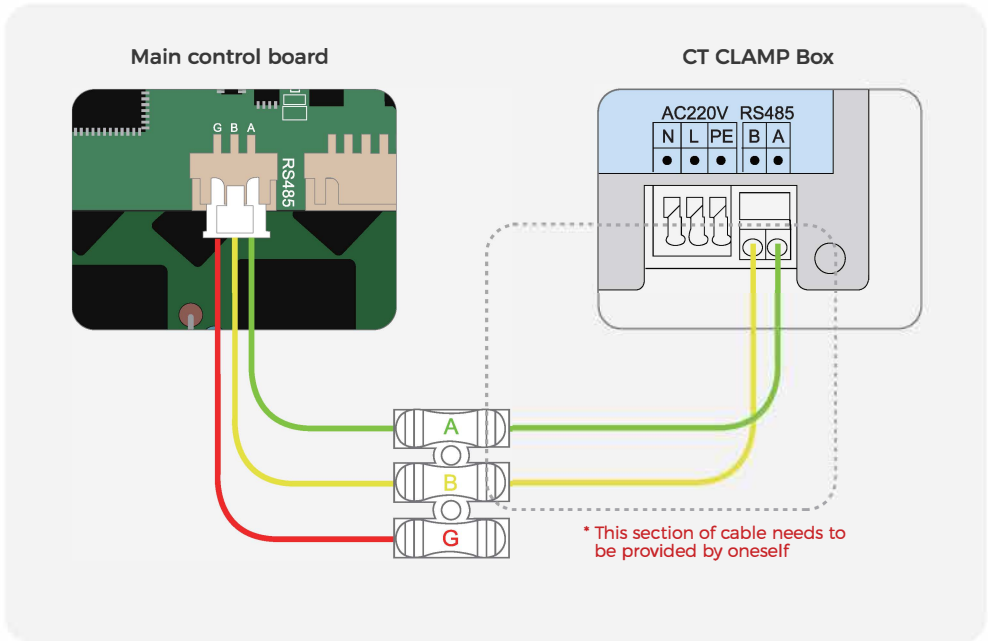

Find the RS485 interface on the main control board and connect it as shown in the figure above. The single-phase and three-phase connection methods are the same.

• Option 2: WIFI configuration instructions

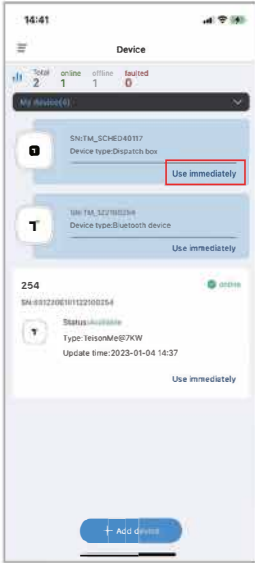

Press "Use immediately" to enter main interface

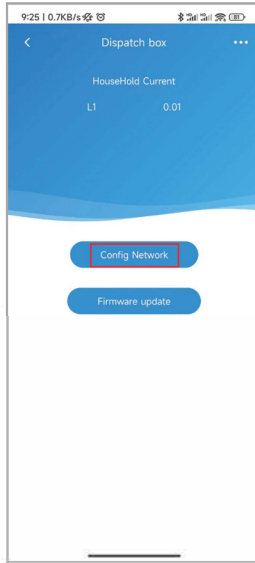

Press "Config Network", then go to the interface of Link Wifi network, remember to choose the wifi in 2.4G and type into the correct password, to link to router.

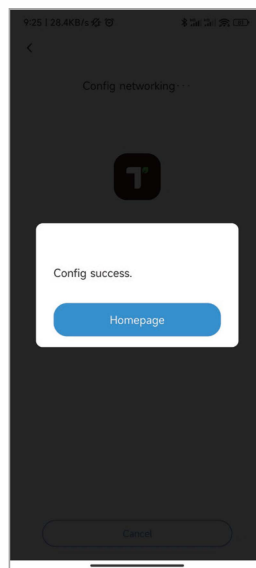
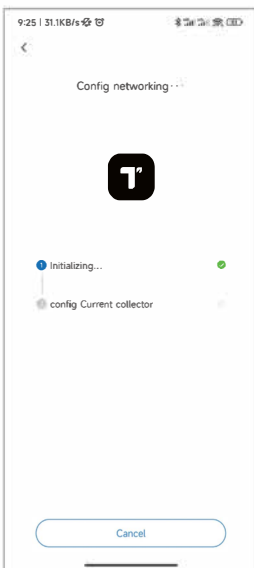
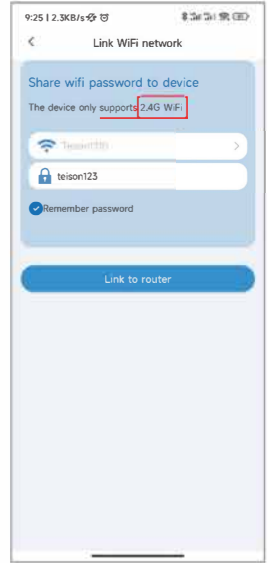

Wait for a while, when show "Config success" it means network successfully connected

5. Setting

5.1 Normal mode

EVC Charging current = maximum grid current (set on APP) - household load current



APP settings



Under this mode, the charger will adjust the real-time charging current according to limitation of 'Household current', which will avoid the overload.

When the residual available current in household supply is less than 6A, the charger will be stopped.

5.2 Solar mode

- 1 Solar power supply current - Household load current \geq EVC charging current (set on APP)

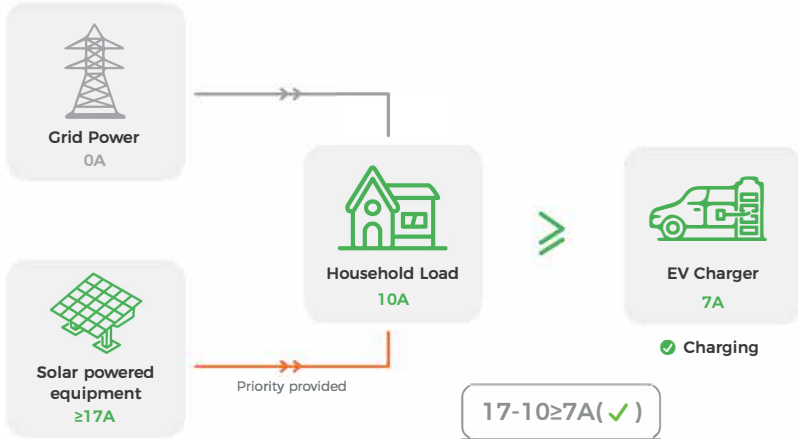

When solar energy is more than real-time household load and residual current over 7A, the charger will work by available solar current. No current comes from Grid.

- 2 Solar power supply current - Household load current $<$ EVC charging current (set on APP)

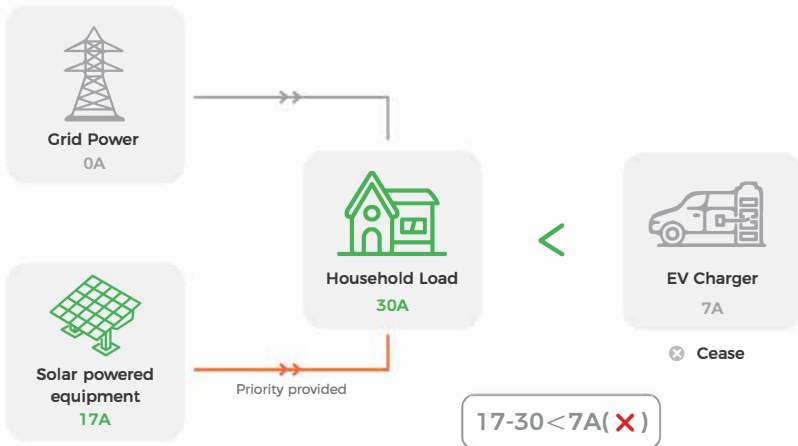

When solar energy is less than real-time household load or residual current lower than 7A, the charger will stop working until residual current over 7A.

Users can adjust the 'Solar Current Limit' on the APP to set the min starting current.

APP settings



5.3 Boost mode

Total supply current - Household load current \geq EVC charging current (full power)

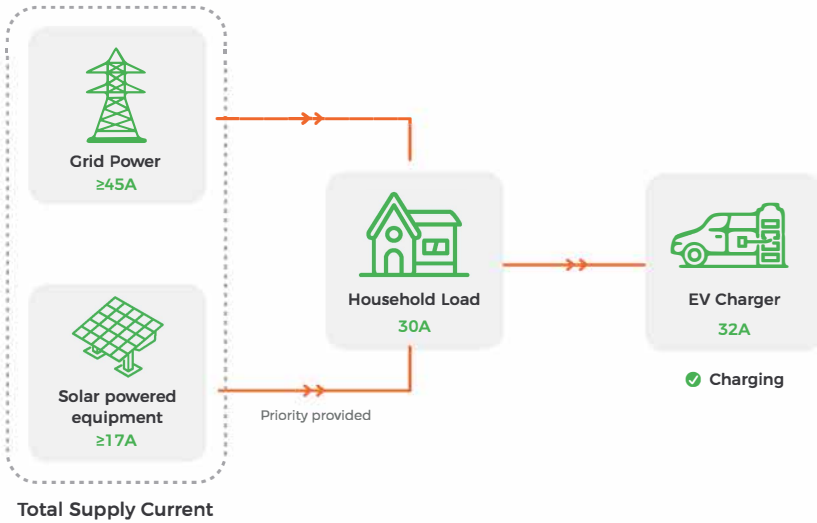







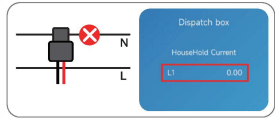

Under Boost mode, the charger will output max charging current and be prior to use residual solar current. If the residual solar current can't support the max charging current, It's allowed to be powered by Grid.

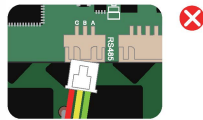
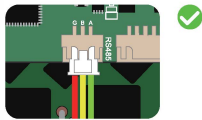
APP settings

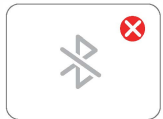
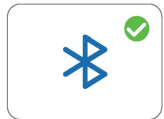

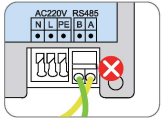
6. Troubleshooting

LED light status	Type	Potential Cause	Action
	online	 <p>CT is stuck on the wrong power line, and the APP detects that the current is displayed as 0</p>	 <p>Check if the CT position is correct, and the APP detects that the current is normal</p>
		 <p>Loose RS485 interface</p>	 <p>Ensure that the wiring is intact</p>
	offline	 <p>Bluetooth not connected</p>	 <p>Reconnect Bluetooth</p>
		 <p>WIFI not connected</p>	 <p>Reconnect WIFI</p>
		 <p>Communication line connection error</p>	 <p>Reconnect the communication line</p>
	fault		