

Installation Manual  
THM-0600 Touch Screen Programmable Thermostat  
Version 1.0.0



**HBX**

THM-0600

---

HBX Control Systems Inc.

# TABLE OF CONTENTS

<b>Introduction</b>	<b>Index</b>
Safety symbols and Warnings	Index
Receipt and Inspection	1
Description	1
Technical data and dimensions	1
<b>Programming THM-0600</b>	<b>2 - 15</b>
- Navigating the THM-0600	2
- Setting the THM-0600	2 - 5
- Special Functions	2 - 6
- Setup Menu	7 - 19
<b>Installation and Wiring</b>	<b>20-22</b>
<b>Troubleshooting Guide</b>	<b>23-24</b>
<b>Limited Warranty</b>	<b>25</b>

## INTRODUCTION

This manual will help with the installation, parameter setting, troubleshooting and general maintenance requirements for the controller. To guarantee the safe and reliable operation of this control, you must first read this manual in detail and take particular note to any and all warnings or caution directives prior to connecting to AC power. Only suitably qualified individuals with formal training in electrical and HVAC controls should attempt the installation of this equipment. Incorrect wiring and installation will affect the warranty provided with this unit. Wiring must be completed in accordance with the codes and practices applicable to the jurisdiction for the actual installation.

The HBX THM-0600 is a microprocessor based controller and as such is not to be regarded as a safety (limit) control. Please consult and install the heating or cooling appliance in accordance with the manufacturer's recommendations.

## SAFETY SYMBOLS



### **Precaution**

A measure taken in advance to prevent dangerous or an unpleasant event.



### **Drawing Reference**

Refer to the specified electrical or mechanical drawing at the back of the manual.



**WARNING:** This product can expose you to chemicals including lead, which is known to the State of California to cause cancer and birth defects or other reproductive harm. For more information go to [www.P65Warnings.ca.gov](http://www.P65Warnings.ca.gov).

# RECEIPT & INSPECTION

After receiving, inspect the unit for any possible physical damage that may have occurred during transportation. After unpacking the unit make sure the box contains:

- 1 x Universal sensor (Part #029-0045)
- 1 x Thermostat THM-0600
- 1 x Thermostat Wall Cutout Template
- Instruction Manual

## DESCRIPTION

The THM-0600 is a programmable thermostat designed to be used with the ZON-0600 Zone Control, and ThermoLinX mobile app.



**It is normal for the THM-0600 screen to remain off up to 120 seconds upon start-up.**

The THM-0600 has two external sensor inputs, multiple heating/cooling modes and can function as a digital setpoint/aquastat.

Some features of the THM-0600 are:

- Dual stage heating or cooling
- P.I.D. algorithm
- Large, full colour touch screen display
- Humidity Control
- Includes external sensor



**The THM-0600 is only compatible with the ZON-0600 Zone Control**

## TECHNICAL DATA AND DIMENSIONS

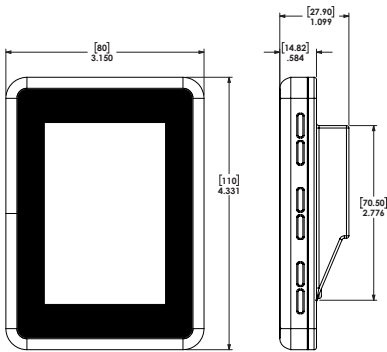

### Technical Data

2 x External Thermistor Input  
1 x Power and Communication  
1 x Humidity Sensor

**Input power:** 5VDC 120mA

**Dimensions:** 80 x 110 x 26mm

### ETL Listings:

Only used with ZON-0600  
ETL Control No. 3068143

**Storage:** +10C to +40C

**Languages:** English

# INSTALLATION AND WIRING

## Mounting Instructions

In order to assure proper room temperature, it is important to identify the ideal location of the thermostat. It should be approximately 5 feet from the floor and at least 1 foot from door openings on an interior wall. Avoid exposing the thermostat to direct sunlight, to air flows (doors, windows, etc.) as well as to heat sources. Ensure the cavity that the thermostat will be installed in is well insulated.

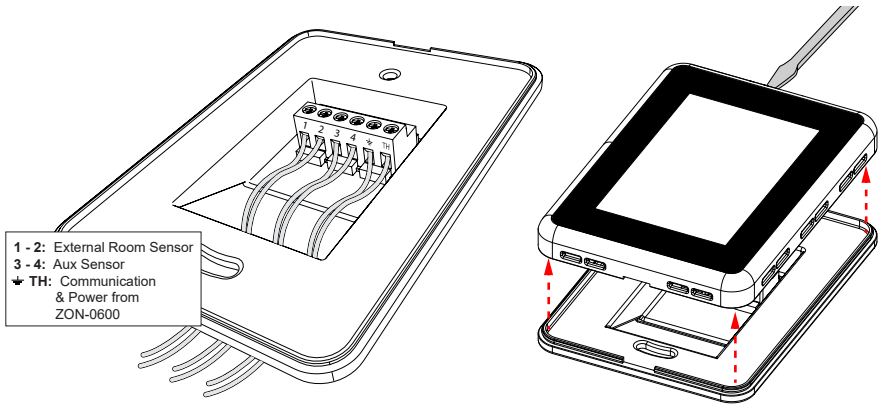

Use a screwdriver to gently pop the front cover off from the top of the thermostat, and then remove the front to expose wiring terminals.

**Do not use the screwdriver on the bottom of the thermostat. This can cause damage to the THM-0600**

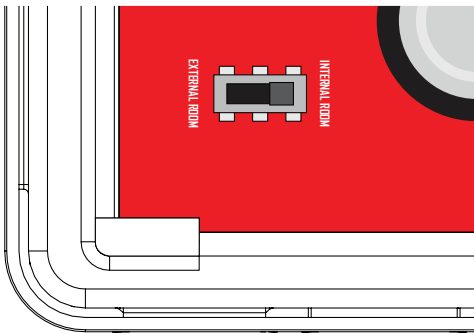

### External Room Thermistor

On the THM-0600, the room thermistor switch is located on the bottom left corner of the thermostat.

toggling this switch will allow the user to alternate between the built in room thermistor on the THM-0600, or an external room thermistor connected to pins 1 and 2 on the THM-0600.

# PROGRAMMING THM-0600

## Navigating the Thermostat

The touchscreen of this thermostat makes it easy to change used settings. Touch any item to adjust its setting excluding the time on the home screen.

Simply touch the temperature to adjust your desired target temperature. Pressing the  menu icon on top right corner allows you to view the main "Setup Menu" options. Pressing the back icon allows you to return to the home screen or setup menu.

Touching the area below the current temperature allows you to see what current demands are present.

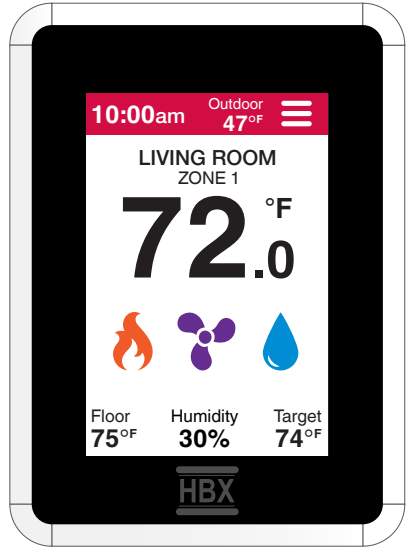

## How to set target temperature

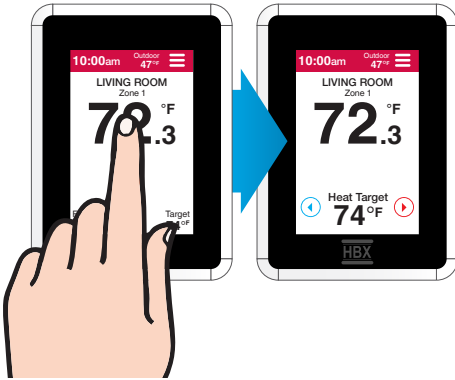

## How to see Current Demand

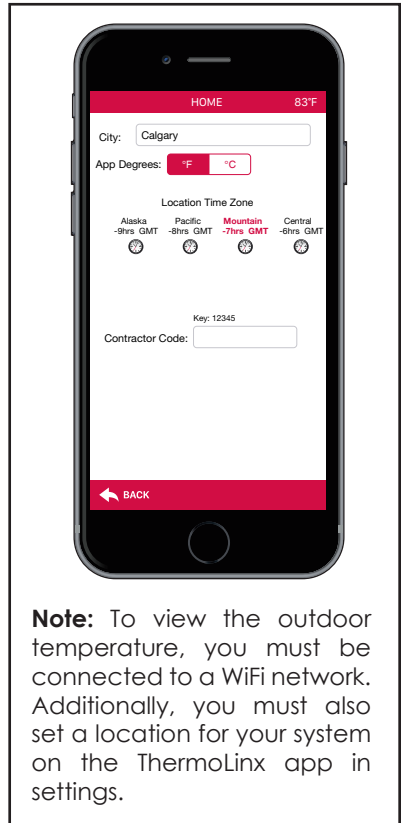

**Note:** To view the outdoor temperature, you must be connected to a WiFi network. Additionally, you must also set a location for your system on the ThermoLinx app in settings.

# Setting the Thermostat

## Special Functions

Enter the “**Special Functions**” screen by touching and holding down the  menu icon for 5 seconds (from the status screen). To select the desired option, simply touch any item to adjust it's setting.

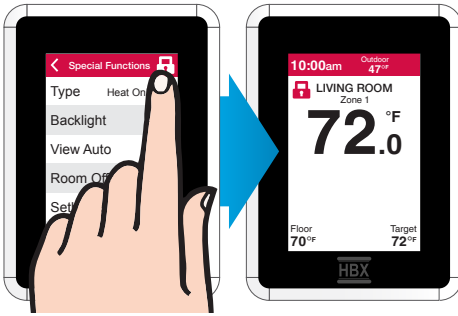

### Lockout Thermostat

In the special functions menu, press and hold the  lock icon on the top right corner for 20 seconds. The screen will automatically go to the main screen and the thermostat will display a lock icon.

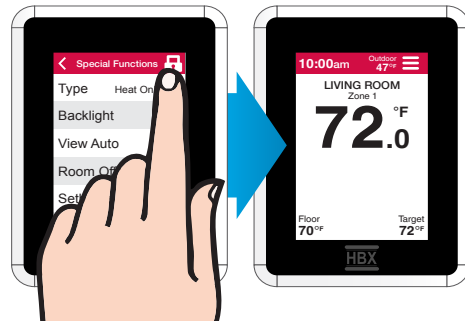

### Unlock Thermostat

Repeat the same process as locking the thermostat. Press and hold the time (clock) on the top left corner on the main screen for 20 seconds. The lock on the screen will go away.



When the thermostat is locked the menu bar is no longer displayed. To access special functions, hold the spot where the icon would appear (top right corner).



No settings will be able to be changed when the thermostat is locked. Only on the Thermolinx mobile app you will have the ability to still make changes. When the Thermostat is locked, only minimal temperature target adjustment can be made. 2°C/3°F above/under.

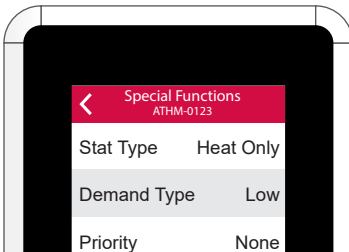

### Sync Code

This number is the identifier used in the HBX Thermolinx App to connect to your thermostat.

**Type** - Select between Heating, Cooling, and a variety of combined modes.

◀ Special Functions  
ATHM-0000

▶ Stat Type Heat Only

Demand Type Low

Priority None

THM Mode Air

Aux Sensor Floor

Room Offset 0°

Fancoil Setup >

### Heat Only Function

Select the "Heat Only Function" for applications using a single heating source.

◀ Special Functions  
ATHM-0000

▶ Stat Type Cool Only

Demand Type Low

Priority None

THM Mode Air

Aux Sensor Floor

Room Offset 0°

Fancoil Setup >

### Cool Only Function

Select the "Cool Only Function" for applications using a single cooling source.

◀ Special Functions  
ATHM-0000

▶ Stat Type Heat and Cool

Demand Type Low

Priority None

THM Mode Air

Aux Sensor Floor

Room Offset 0°

Fancoil Setup >

### Heat and Cool Function

Select the "Heat and Cool Function" for applications using a single heating source and a single cooling source.

◀ Special Functions  
ATHM-0000

▶ Stat Type 2 Stage Heat

Demand Type Low

Priority None

THM Mode Air

Aux Sensor Floor

Room Offset 0°

Fancoil Setup >

### 2 Stage Heat Function

Select the "2 Stage Heat Function" for applications using 2 stage heating.

◀ Special Functions  
ATHM-0000

▶ Stat Type 2 Stage Cool

Demand Type Low

Priority None

THM Mode Air

Aux Sensor Floor

Room Offset 0°

Fancoil Setup >

### 2 Stage Cool Function

Select the "2 Stage Cool Function" for applications using 2 stage cooling.

Special Functions ATHM-0000	
Stat Type	2 Heat with Cool
Demand Type	Low
Priority	None
THM Mode	Air
Aux Sensor	Floor
Room Offset	0°
Fancoil Setup	>

## 2 Heat with Cool Function

Select the “2 Heat with Cool Function” for applications using 2 stage heating and 1 stage cooling.

Special Functions ATHM-0000	
Stat Type	2 Cool with Heat
Demand Type	Low
Priority	None
THM Mode	Air
Aux Sensor	Floor
Room Offset	0°
Fancoil Setup	>

## 2 Cool with Heat Function

Select the “2 Cool with Heat Function” for applications using 2 stage cooling and 1 stage heating.

Special Functions ATHM-0000	
Stat Type	2 Heat and 2 Cool
Demand Type	Low
Priority	None
THM Mode	Air
Aux Sensor	Floor
Room Offset	0°
Fancoil Setup	>

## 2 Heat and 2 Cool Function

Select the “2 Heat and 2 Cool Function” for applications using 2 stage heating and 2 stage cooling.

This option is only available in Geo Mode. You must set Geo mode to  to enable this function.

**Demand** - This option allows the user to determine what happens when the thermostat makes a call.

Special Functions ATHM-0000	
Stat Type	Heat Only
Demand Type	Low
Priority	None
THM Mode	Air
Aux Sensor	Floor
Room Offset	0°
Fancoil Setup	>

**Low** - Low Temperature Demand

**High** - High Temperature Demand

**DHW** - Domestic Hot Water (Digital Aquastat)

**Fan** - Fancoil Demand

**Note: DHW only available in heat only type**



**Priority** - This option allows the user to set a priority on a zone(s) over other zone(s). Priorities range from 1 (highest) to 7 (lowest). Higher priorities will lock out lower priorities until the demand has been satisfied. Multiple zones can be given the same numbered priority.

Special Functions ATHM-0000	
Stat Type	Heat Only
Demand Type	Low
Priority	None
THM Mode	Air
Aux Sensor	Floor
Room Offset	0°
Fancoil Setup	>

The Priority Shield option allows a zone to ignore other priorities from other zones.

A priority set to none will have no priority and will be overridden by all other zone priorities.

Priority 1 is a timed priority of 60 minutes, generally used for DHW.

**Mode** - This option allows you to select between Air, Floor and Dual sensor modes. If you are setting your Thermostat as a DHW demand the thermostat will automatically configure your sensor to a digital Aquastat.

Special Functions ATHM-0000	
THM Mode	Air
Aux Sensor	Floor
Room Offset	0°
Fancoil Setup	>
4-Pipe Geo	OFF
Default Setup	>
Password	>

### Air

Thermistor within the thermostat sensing temperature providing feedback for the specific room or zone being controlled by the thermostat.

Special Functions ATHM-0000	
THM Mode	Floor
Aux Sensor	Floor
Differential	6°
Room Offset	0°
Fancoil Setup	>
4-Pipe Geo	OFF
Default Setup	>

### Floor

Sensor temperature providing feedback from the floor surface to the thermostat. This mode will run the thermostat on floor temperature only. Aux sensor will automatically be set to floor.



**Only available when heating modes are the primary function. Must have floor sensor connected.**

Special Functions ATHM-0000	
THM Mode	Floor
Aux Sensor	Floor
Differential	6°
Room Offset	0°
Fancoil Setup	>
4-Pipe Geo	OFF
Default Setup	>

### Floor Mode: Differential

When in floor mode, the differential option is set to allow a differential around the target to reduce the chances of short cycling.

*Ex. A differential of 4°F is 2°F above the setpoint and 2°F below the setpoint.*

Special Functions ATHM-0000	
THM Mode	Dual
Aux Sensor	Floor
Floor Min	70°
Floor Max	80°
Room Offset	-20°
Fancoil Setup	>
4-Pipe Geo	OFF

### Dual

Sensor temperature providing feedback for both the air temperature and floor sensor temperatures. Aux sensor will automatically be set to floor.



**Only available when heating modes are the primary function. Must have floor sensor connected.**

Special Functions ATHM-0000	
THM Mode	Dual
Aux Sensor	Floor
Floor Min	70°
Floor Max	80°
Room Offset	-20°
Fancoil Setup	>
4-Pipe Geo	OFF

### Dual Mode: Min/Max

**Max** - The thermostat will not allow the floor temperature to go above this value, protecting the integrity of the floor covering.

**Min** - The thermostat will not allow the floor temperature to go below this value.

## Aux Sensor - Auxiliary thermistor

Special Functions ATHM-0000	
Stat Type	Heat Only
Demand Type	Low
Priority	None
THM Mode	Air
Aux Sensor	Floor
Room Offset	0°
Fancoil Setup	>

**None** – No external thermistor attached.

**Floor** – Displays the floor temperature using external 1 sensor

**Room** - Disregards internal sensor, uses external

**Outdoor** – Uses external sensor to display outdoor temperature

**RM/Ave** – Averages auxiliary sensor and internal sensor, or optional external room sensor

**Floor Ave** – Averages auxiliary and optional external floor sensor in lieu of room sensor



**When using the external room/floor sensor on pins 1 and 2 ensure the dipswitch is set to external.**

**Room Offset** - This feature allows you to program an offset. In the case that the thermostat is not reading the same temperature as the actual temperature in the room.

Special Functions ATHM-0000	
Stat Type	Heat Only
Demand Type	Low
Priority	None
THM Mode	Air
Aux Sensor	Floor
Room Offset	0°
Fancoil Setup	>

**Example** Actual Room Temperature 72 °F.  
Direct Sunlight causes Thermostat to show 78 °F.  
The user can put an offset of -6 °F to get the temperatures to match.

**Minimum value** -20°F  
**Maximum value** 20°F

**Fancoil Setup** - This setting takes you to the Fancoil Setup Menu.

Special Functions ATHM-0000	
THM Mode	Air
Aux Sensor	Floor
Room Offset	0°
Fancoil Setup	>
4-Pipe Geo	OFF
Default Setup	>
Password	>

If you are utilizing a fancoil, you will have access to the following settings:

**Fan On Demand**  
**Zone On Demand**  
**Temperature Averaging**  
**Fan Mode**  
**Damper Mode**

Fancoil Setup	
Fan ON Demand	OFF
Zone ON Demand	OFF
Temp Average	None
Stage Delay	15 mins
Damper Mode	OFF

### Fancoil Setup: Fan On Demand

This option will turn the fan on with any fancoil demand.

Fancoil Setup	
Fan ON Demand	OFF
Zone ON Demand	OFF
Temp Average	None
Stage Delay	15 mins
Damper Mode	OFF

### Fancoil Setup: Zone On Demand

This option will turn the corresponding zone output on with a fancoil demand.

Fancoil Setup	
Fan ON Demand	OFF
Zone ON Demand	OFF
Temp Average	None
Stage Delay	15 mins
Damper Mode	OFF

### Fancoil Setup: Temperature Averaging

This option will average the temperature between thermostats (User Selectable), when that average falls below or above the setpoint, depending on if it's in heating or cooling, then the thermostat will make a call for heating or cooling on the fancoil.

**None** - No temperature averaging

**1-2** - Averaging between thermostats 1 and 2

**1-3** - Averaging between thermostats 1, 2 and 3

**1-4** - Averaging between thermostats 1, 2, 3 and 4

Fancoil Setup	
Fan ON Demand	OFF
Zone ON Demand	OFF
Temp Average	None
Stage Delay	15 mins
Damper Mode	OFF

### Fancoil Setup: Stage Delay

Use this setting to adjust the lagtime between stage 1 and stage 2. This option is only available when 2 heating or cooling stages are selected.

**Default** - 15m

**Range** - 1m - 240m

Fancoil Setup	
Fan ON Demand	OFF
Zone ON Demand	OFF
Temp Average	None
Stage Delay	15 mins
Damper Mode	OFF

### Fancoil Setup: Damper Mode

This option utilizes the zone output as a damper zone.

**OFF** - No damper being utilized in current setup.

**Single N/O**: Corresponding zone output is utilizing normally open dampers.

**Single N/C**: Corresponding zone output is utilizing normally closed dampers.

**2 Stage N/O** - 1st stage is radiant and the second stage is utilizing a normally open damper. This option will require to use the next corresponding zone output to accommodate for the second stage damper. This option is only available for Zones 1 and Zone 3.

**2 Stage N/C** - 1st stage is radiant and the second stage is utilizing a normally closed damper. This option will require to use the next corresponding zone output to accommodate for the second stage damper. This option is only available for Zone 1 and Zone 3.



**When damper mode is enabled you will not be able to utilize 4-Pipe Geo mode.**

**4-Pipe Geo** - Controls a 4 pipe system in a geothermal application. This option will require to use the next corresponding zone output to accommodate for cooling. This is only available for Zone 1 and 3.

Special Functions ATHM-0000	
THM Mode	Air
Aux Sensor	Floor
Room Offset	0°
Fancoil Setup	>
4-Pipe Geo	OFF
Default Setup	>
Password	>

**OFF** - 4-Pipe Geo is disabled  
**ON** - 4-Pipe Geo is enabled



**When 4-Pipe Geo is enabled you will not be able to utilize damper mode.**

**Default Setup** - Restores the thermostat to factory default settings or previously saved settings.

Special Functions ATHM-0000	
THM Mode	Air
Aux Sensor	Floor
Room Offset	0°
Fancoil Setup	>
4-Pipe Geo	OFF
Default Setup	>
Password	>

**Save Current Settings** - This option will save the current settings in the event the settings get changed in the future.  
**Load Current Settings** - This options will load the last saved current settings.  
**Factory Reset** - Reset all settings back to default.

**Password** - Displays the current password to connect to the ThermoLinx App.

Special Functions ATHM-0000	
THM Mode	Air
Aux Sensor	Floor
Room Offset	0°
Fancoil Setup	>
4-Pipe Geo	OFF
Default Setup	>
Password	>

Selecting this option allows you to change the password.  
**No** - Password will remain the same  
**Yes** - The Thermostat will randomly generate a new password



**Passwords should be updated when device ownership has changed.**

# Setting the Thermostat

## Setup Menu

Enter the “**Setup Menu**” screen by touching the  menu icon. To select the desired option, simply touch any item to adjust it's setting.

**Schedules** - Allows thermostat temperatures to be scheduled up to 4 time periods for weekdays and weekends.

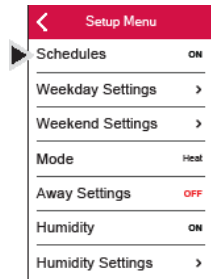

**OFF** - Disables scheduling  
**ON** - Enabled scheduling

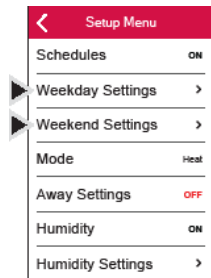

**Weekday Settings (Monday to Friday)** - Adjust four time periods within the weekday program menu.  
**Weekend Settings (Saturday to Sunday)** - Adjust four time periods within the weekend program menu.

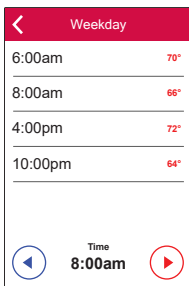

### Setting a schedule

**Time** - Select the time for the schedule to be started by pressing the time on the desired schedule event.

**Cooling Temperature (Blue)** - Select the cooling temperature and adjust accordingly for each schedule event.

**Heating Temperature (Red)** - Select the heating temperature and adjust accordingly for each schedule event.



**Heating/Cooling temperatures will only be displayed if thermostat has a heating/cooling type selected.**



**The cooling setting must be a minimum of 2°F higher than the heating setting.**

**Heating/Cooling Target** - The chosen setpoint for heating and cooling zones. Targets will be accessible in relation to the thermostat type chosen.

Weekday	
6:00am	70°
8:00am	66°
4:00pm	72°
10:00pm	64°

Heating  
**70**

**Heating Target** - Change the minimum temperature for your zone. If the temperature in the zone falls below this temperature, heating will come on.

**Cooling Target** - Change the maximum temperature for your zone. If the temperature in the zone increases above this temperature, cooling will come on.



**This feature is unavailable if schedules are enabled.**

**Mode** - This option allows setting of the thermostat mode to auto, heat, cool or off.

Setup Menu	
Schedules	ON
Weekday Settings	>
Weekend Settings	>
Mode	Heat
Away Settings	OFF
Humidity	ON
Humidity Settings	>

**Auto** - The thermostat maintains cooling and heating as needed

**Heat** - Overrides the thermostat to heat only mode

**Cool** - Overrides the thermostat to cool only mode

**Off** - Disable heating and cooling on the thermostat

**Away Settings** - Set the temperature for when the zone is in Away Mode. Away mode will override the schedule to a lower/higher temperature.

Setup Menu	
Schedules	ON
Weekday Settings	>
Weekend Settings	>
Mode	Heat
Away Settings	OFF
Humidity	ON
Humidity Settings	>

**Heat Target** - This allows the end user to select a heat target when away mode is enabled.

**Cool Target** - This allows the end user to select a cool target when away mode is enabled.



**Away heat target must never exceed thermostat target. Away cool target must never be below thermostat target.**

**Humidity** - Enable or disable humidity settings on the thermostat.

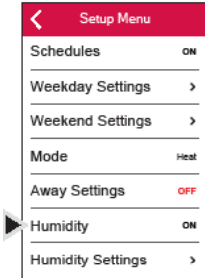

**ON** - Enables the thermostat zone to humidify or dehumidify.

**Auto** - Enables the thermostat to humidify or dehumidify to the target % automatically based on the outdoor temperature. No manual adjustment is required. The zoning system must be connected to a wifi network for this feature to be applicable or the thermostat must utilize an external sensor monitoring the outdoor temperature. You must enter your location on the ThermoLinx app for Auto Humidity to work.

**OFF** - Disables the Thermostat zone to humidify or dehumidify.

**Humidity Settings** - Configure humidity settings on the thermostat.

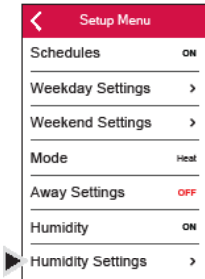

**Fan w/ Humidity** - This option will turn on your fan when there is a humidity demand.

**Target** - When humidity is set to ON, use this setting to manually adjust your humidity target.

**Type** - This option allows you to set the thermostat to humidify or dehumidify.

**Fan Settings** - Enable or disable fan settings on the thermostat.

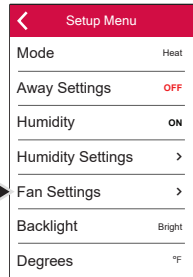

### Fan Settings: Fan Mode

**OFF** - Fan is off

**ON** - Enables the fan to run constantly, regardless of whether the thermostat is calling for heating or cooling

**INT** - This setting will set the ON/OFF time for the intermittent fan

*Ex: The fan will come on for **15 min** every **2H**. Set (Int Fan On: **15 min**) & (Int Fan Off: **2H**)*



**Backlight** - This option adjusts the brightness of the thermostat screen during idle.

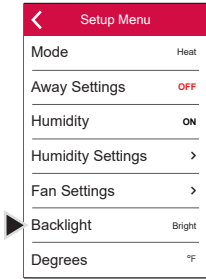

**OFF** - Screen backlight is off during idle  
**BRIGHT** - Screen backlight is at 100%  
**DIM** - Screen backlight is at 50%

**Degrees** - This option will change the thermostat temperature to either Celsius (°C) or Farenheit (°F).

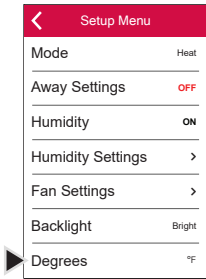

**°C** - Display temperatures in Celcius  
**°F** - Display temperatures in Farenheit

THM-0600 Drawing 1

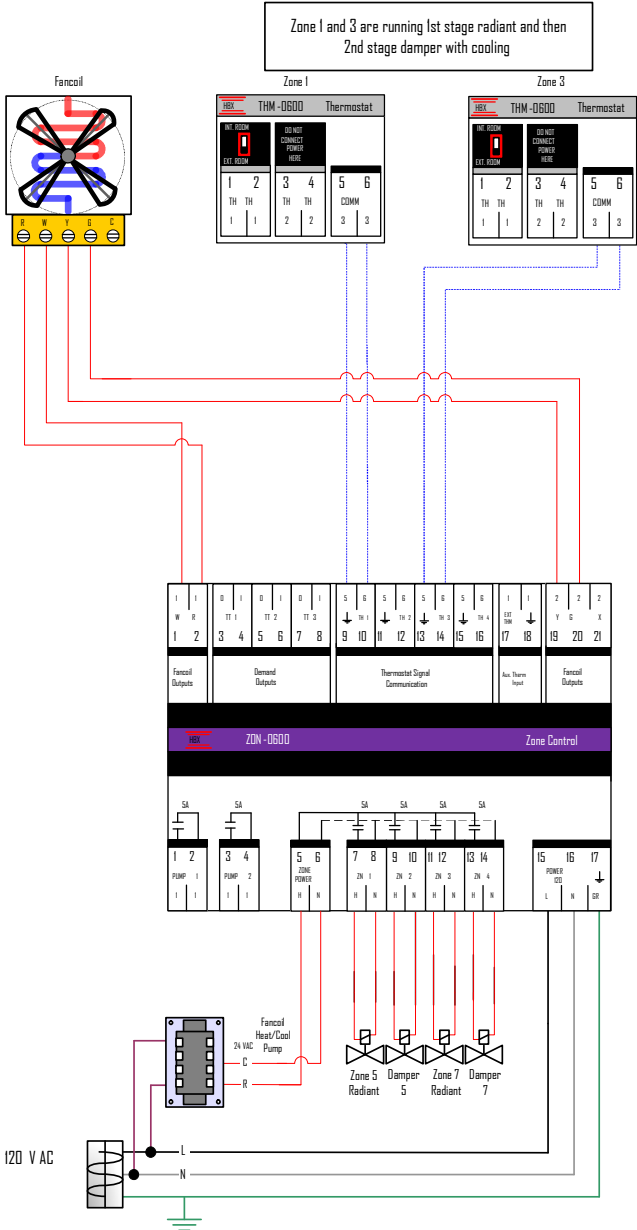

# THM-0600 Drawing 2

To use external room thermostat, toggle dip-switch from Internal to External on THM-0600

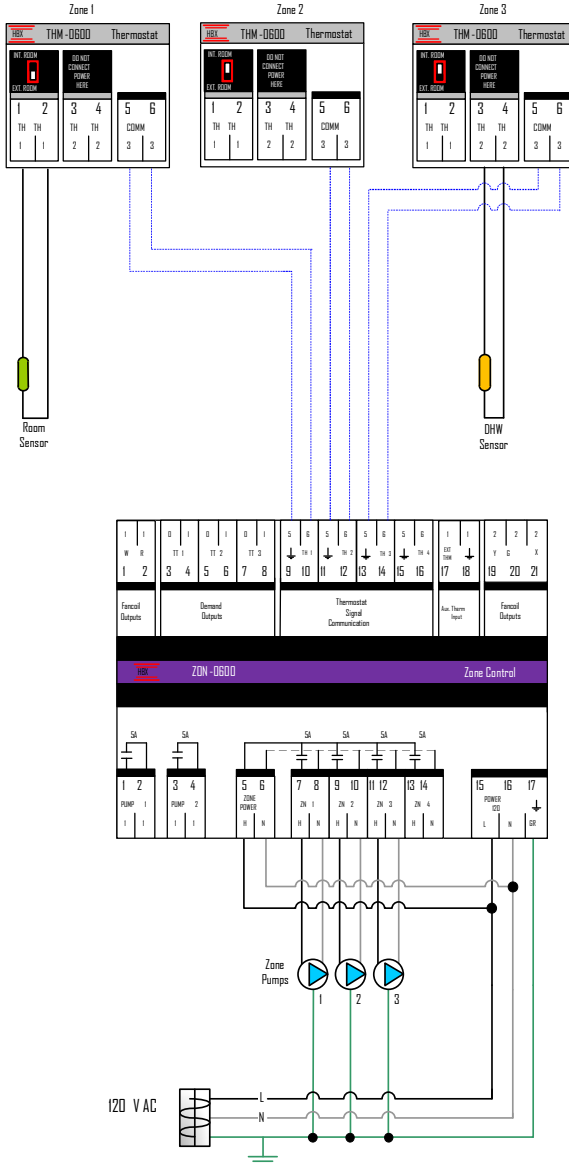

# THM-0600 Drawing 3

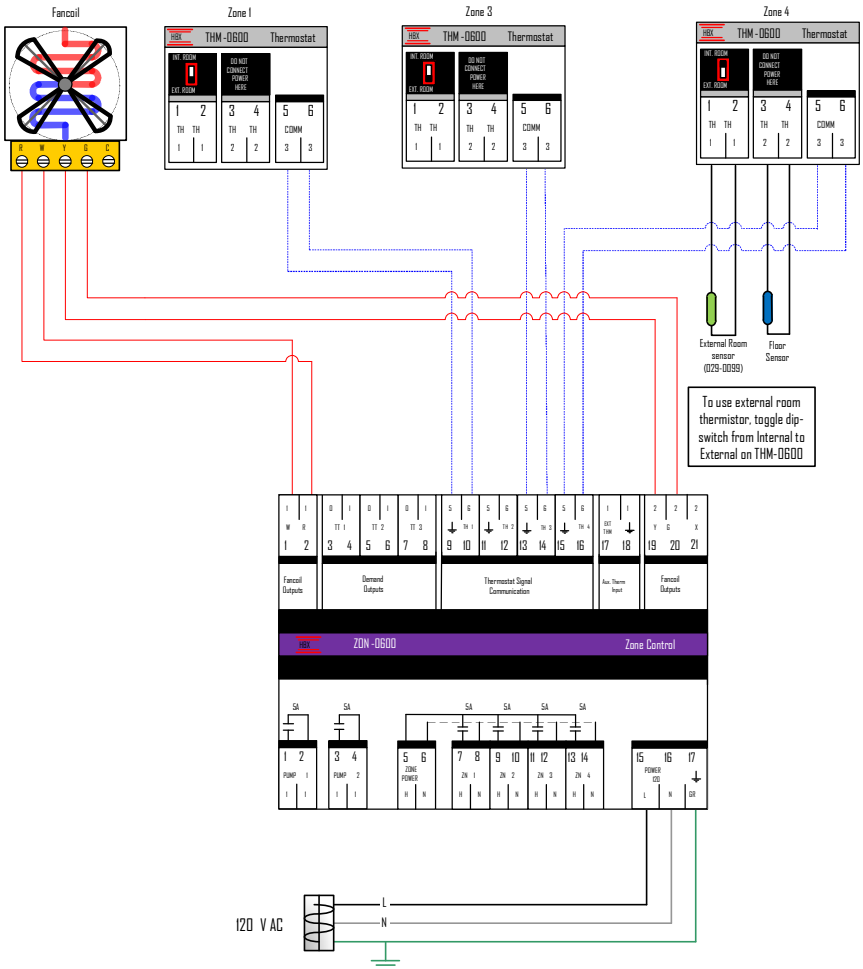

# TROUBLESHOOTING GUIDE

ISSUE	POSSIBLE CAUSES & RESOLUTIONS
<b>Blank Screen</b>	<ul style="list-style-type: none"><li>• Check the ZON-0600 power</li><li>• Check wiring polarity between the THM-0600 and ZON-0600 module.</li><li>• Ensure zones 1 and 3 damper/4-pipe is set correctly.</li></ul>
<b>Stage 2 won't come on</b>	<ul style="list-style-type: none"><li>• Check stage delay in fancoil setup for proper time.</li><li>• In special functions ensure you have selected correct thermostat type.</li></ul>
<b>Demand not coming on</b>	<ul style="list-style-type: none"><li>• Demands may take up to 5 minutes to operate due to P.I.D algorithm.</li><li>• Verify wiring on the ZON-0600 module.</li><li>• Check priorities settings in special functions.</li><li>• Check the mode settings</li></ul>
<b>Temperature not displaying correct value</b>	<ul style="list-style-type: none"><li>• If it is showing dash lines ensure that the proper thermostat mode is selected in special functions.</li><li>• Ensure aux sensor(s) is wired correctly.</li><li>• Make sure the external room dipswitch on the board is in the correct position.</li></ul>
<b>Target changing</b>	<ul style="list-style-type: none"><li>• Check the schedule</li><li>• If you're in auto changeover, then the target can change to either heating target or cooling target based on actual room temperature.</li></ul>

# TROUBLESHOOTING GUIDE

ISSUE	POSSIBLE CAUSES & RESOLUTIONS
<b>Thermostat(s) not showing up on ThermoLinX App</b>	<ul style="list-style-type: none"><li>• <i>Verify sync code and password on thermostat is correct when adding devices</i></li><li>• <i>Manually check in thermostat(s)</i></li><li>• <i>Ensure zone modules are linked</i></li><li>• <i>System is not connected to the internet</i></li></ul>
<b>Thermostat settings not all displayed on the ThermoLinX App</b>	<ul style="list-style-type: none"><li>• <i>Contact HBX Technical Support for contactor code to unlock advanced settings.</i></li></ul>

For additional assistance with the THM-0600, please contact our Technical Support Department toll free at:

**+1 (855) 410-2341**

## LIMITED WARRANTY

HBX Controls warrants each of its products to be free from defects in workmanship and materials under normal use and service for a period of 24 months from date of manufacture or 12 months from date of purchase from an HBX Authorized Dealer, if within the above documented period after date of manufacture.

If the product proves to be defective within the applicable warranty period, HBX on its sole discretion will repair or replace said product. Replacement product may be new or refurbished of equivalent or better specifications, relative to the defective product. Replacement product need not be of identical design or model. Any repair or replacement product pursuant to this warranty shall be warranted for not less than 90 days from date of such repair, irrespective of any earlier expiration of original warranty period. When HBX provides replacement, the defective product becomes the property of HBX Controls.

Warranty Service, within the applicable warranty period, may be obtained by contacting your nearest HBX Controls office via the original Authorized Agent and requesting a Return Material Authorization Number (RMA #). Proof of purchase in the form a dated invoice/receipt must be provided to expedite the issuance of a Factory RMA.

After an RMA number has been issued, the defective product must be packaged securely in the original or other suitable shipping package to ensure that it will not be damaged in transit. The RMA number must be visible on the outside of the package and a copy included inside the package. The package must be mailed or otherwise shipped back to HBX with all costs of mailing/shipping/insurance prepaid by the warranty claimant.

Any package/s returned to HBX without an approved and visible RMA number will be rejected and shipped back to purchaser at purchaser's expense. HBX reserves the right, if deemed necessary, to charge a reasonable levy for costs incurred, additional to mailing or shipping costs.

### Limitation of Warranties

If the HBX product does not operate as warranted above the purchasers sole remedy shall be, at HBX's option, repair or replacement. The foregoing warranties and remedies are exclusive and in lieu of all other warranties, expressed or implied, either in fact or by operation of law, statutory or otherwise, including warranties of merchantability and fitness for a particular purpose/application. HBX neither assumes nor authorizes any other person to assume for it any other liability in connection with the sale, installation maintenance or use of HBX Controls products.

HBX shall not be liable under this warranty; if its testing and examination discloses that the alleged defect in the product does not exist or was caused by the purchasers or third persons misuse, neglect, improper installation or testing, unauthorized attempts to repair or any other cause beyond the range of intended use, or by accident, fire, lightning or other hazard.

### Limitation of Liability

In no event will HBX be liable for any damages, including loss of data, loss of profits, costs of cover or other incidental, consequential or indirect damages arising out of the installation, maintenance, commissioning, performance, failure or interruption of an HBX product, however caused and on any theory of liability. This limitation will apply even if HBX has been advised of the possibility of such damage.

### Local Law

This limited warranty statement gives the purchaser specific legal rights. The purchaser may also have other rights which vary from state to state in the United States, from Province to Province in Canada and from Country to Country elsewhere in the world.

To the extent this Limited Warranty Statement is inconsistent with local law, this statement shall be deemed modified to be consistent with such local law. Under such local law, certain disclaimers and limitations of this statement may not apply to the purchaser. For example, some states in the United States, as well as some governments outside the United States (including Canadian Provinces), may: Preclude the disclaimers and limitations in this statement from limiting the statutory rights of a consumer (e.g. United Kingdom);

Otherwise restrict the ability of a manufacturer to enforce such disclaimers or limitations; or grant the purchaser additional warranty rights which the manufacturer cannot disclaim, or not allow limitations on the duration of implied warranties.

Phone: +1 (403) 720-0029 Fax: +1 (403) 720-0054  
Email: [info@hbxcontrols.com](mailto:info@hbxcontrols.com) Web: [www.hbxcontrols.com](http://www.hbxcontrols.com)

Toll Free Technical Support: +1 (855) 410 2341

