

UL 1686 C1 Pin and Sleeve

100A, 600/250V AC/DC, 2 Pole, 3 Wire

Reversed Service Insulgrip® Receptacle

Features

- Closure cap with neoprene gasket provides a 4X watertight seal while not in use
- All brass sleeve contacts provide reliable electrical contact with mating pins
- O-Rings provide a watertight and dust tight seal around sleeves negating contamination to the wire chamber
- Catalog number and rating are visible while in use, color coded for Style 1 or Style 2

Ordering Information

Description Watertight Insulgrip Receptacle, Reversed Service	UPC 783585012056	Catalog Number HBL3100RS2WR
Device Color Aluminum	Grounding Style Style 2	

Standards

UL Standard 1682
CSA Certified to CSA Spec. C22.2 No. 182.1
UL Listed and CSA Certified Type 4X

Specifications

Housing	Epoxy Painted Aluminum
Gaskets & Seals	Neoprene
Contact Carrier	Thermoset Polyester
Pin Spring	Beryllium Copper
Cover	Epoxy Painted Aluminum

Performance

Electrical	
Current Interrupting	Certified for current interrupting at full rated current
Dielectric Voltage	Withstands 3,000V AC
Max. Working Voltage	600V AC RMS
Mechanical	
Impact Resistance	Per CSA C22.2, No. 182.1, UL 1682
Product Identification	Identification and ratings are permanently fastened to the device housing
Terminal Identification	Terminals identified in accordance with UL 1686(1, 2, 3, Green)
Environmental	
Flammability (Enclosure)	UL 94V-0 and CSA C22.2 No. 0.17
Moisture Resistance	Type 3, 4, 4X per UL 50E and CSA 22.2, No. 94
Operating Temperatures	Max. Continuous 75°C; Min. -40°C w/o impact -25° with impact

Online Resources

Customer Use Drawing
eCatalog
Installation Instructions

HUBBELL

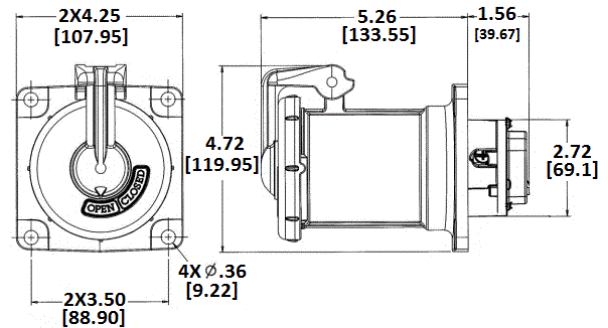

Dimensions in Inches (mm)

Hubbell Wiring Device-Kellems • Hubbell Incorporated (Delaware) • 40 Waterview Drive • Shelton, CT 06484

Phone (800) 288-6000 • Fax (800) 255-1031 • Specifications subject to change without notice.

