

SPECIFICATION

NEXLEDS[®]
NEXLEDS LTD

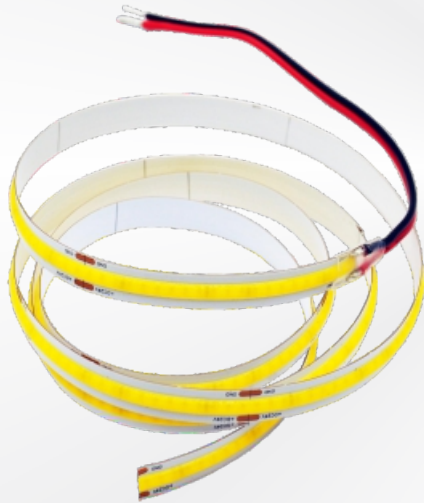

LED Strip Light

NX-08COB336-8W

Specification

PRODUCT NAME :	LED Strip Light		
MODEL NO. :	NX-08COB336-8W-xK-IPxx		
SPECIFICATION :	DC24V, 8W/M		
WORKING TEMP :	-20-50(°C)		
CRI(RA) :	>80		
COLOR :	White Color		
LIGHT SOURCE :	Sanan COB Chip		
LIFE TIME :	50000 hrs		
BEAM ANGLE :	120°		
PRODUCT SIZE :	5000*8mm		
CUTTING LENGTH :	62.5 mm		
IP :	IP20	IP 54	IP65 IP67
APPLICATION :	Residential lighting, decorative lighting; Home, Shop, Hotel.		
WARRANTY :	2 years		
STANDARD :	UL		
CCT & LUMEN:	3000K (730 LM/W)	4000K (770 LM/W)	5000K (770 LM/W)

* The above measurements of watts, brightness and efficiency allowance tolerance ±10%.

* The above measurements are based on IP20.

Feature:

1. Chip-on-board design, un up to 336 chips on single meter reaches even and uniform lighting.
2. Only 2.97mm distance between chips, 62.5mm cutting length.
3. New circuit design to reduce brightness difference from beginning and ending.
4. Double layer 2oz PCB balancing voltage dropping heat dissipations and flexibility.

Dimension:

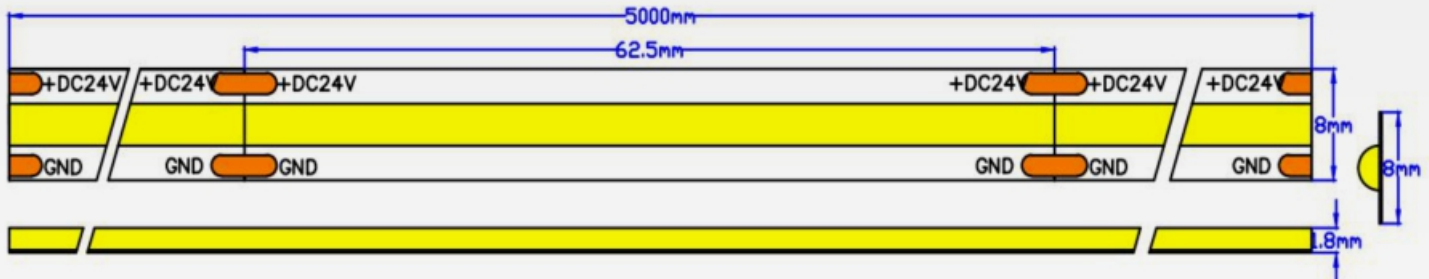

Temp. Curve:

- * The following curve based on 30 minutes testing data. The Temp. changes after powering within 30 minutes.
- * The x-axis indicates the minutes from 1 minutes to 30 minutes.
- * The y-axis indicates the changes of temperatures in Glue, PCB and Room.

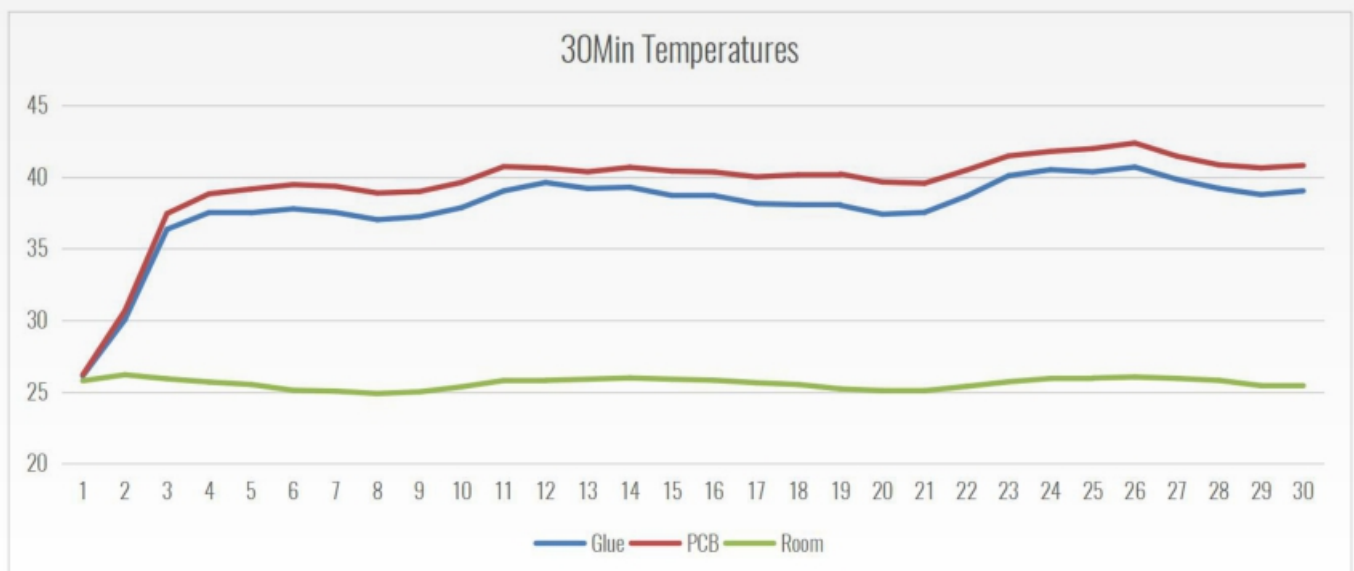

Waterproof Ways:

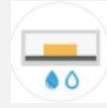
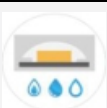
Waterproof Ways	IP Rating	Details
	IP 54	PU or Silicone glue on the surface of the led strips.
	IP 65	Injected with Silicone Tube.
	IP 67	IP67 Extrusion, Integrated Silicone.

Installation Way:

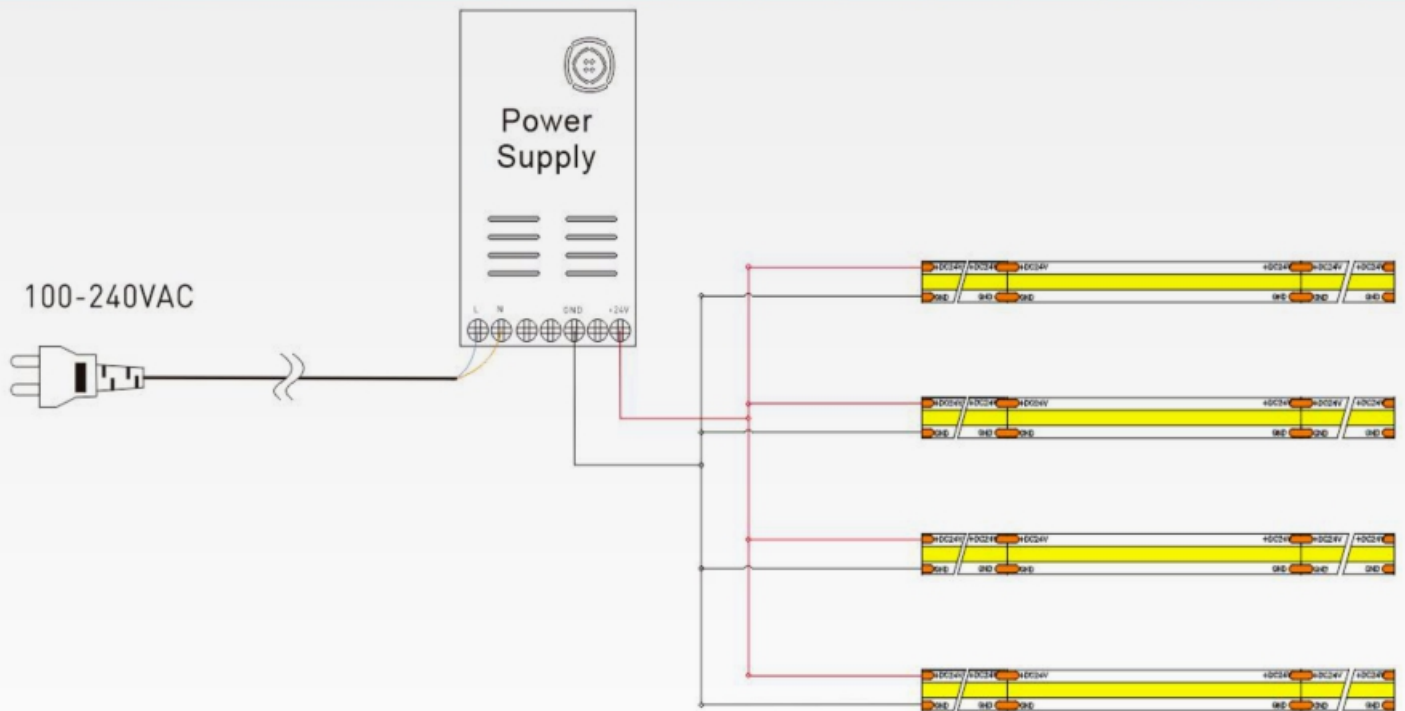

- * The max running length is 5 meters, for over 5 meters please connect in parallel.
- * Make sure of the total watts of COB Strip lights is less than 80% of the power supply's max output.
- * Match the polarities according to the mark ('+' and '-') in the PCB while connecting.