



MARCUS

Marcus Transformer LTD
 Phone: 1-800-267-7376
 Fax: 1-866-205-7526
 Email: Info@marcustransformer.com

TECHNICAL DATA

SINGLE PHASE CONTROL TRANSFORMER

DESCRIPTION	
MODEL	MO100H
Type	Open
VA	100
Primary (Volts)	347 / 380
Secondary (Volts)	120 / 240
Input / Output Amps	0.29 , 0.26 / 0.83 , 0.42
Temperature Rise	80°C
Insulation Class	B (130°C)
Frequency	50 / 60Hz
Polarity	additive
Noise level	less than 40DB
Winding	Copper
Approvals	CE compliant UL listed CSA approved

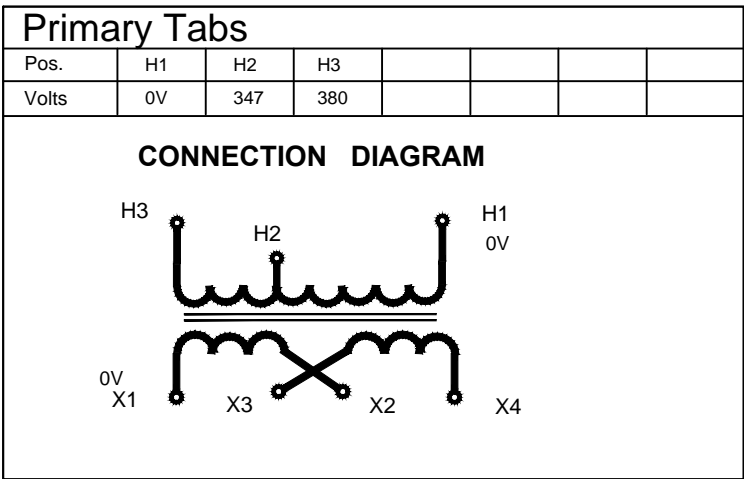

WIRING CONNECTION

PRIMARY :		
VOLTS	CONNECT LINES TO :	
347	H1-H2	
380	H1-H3	
SECONDARY :		
VOLTS	INTERCONNECT:	CONNECT LINES TO :
120	X1-X3 AND X2-X4	X1-X4
240	X2-X3	X1-X4

DIMENSIONS INCHES / MM

VA	A	B	C	D	E	MOUNTING HOLES INCHES / MM	SHIP WEIGHT LBS / KG
100	3.00 76.2	2.50 63.5	3.27 83.1	2.50 63.5	2.50 63.5	0.21 x 0.625 5.3 x 15.9	2.75 1.3

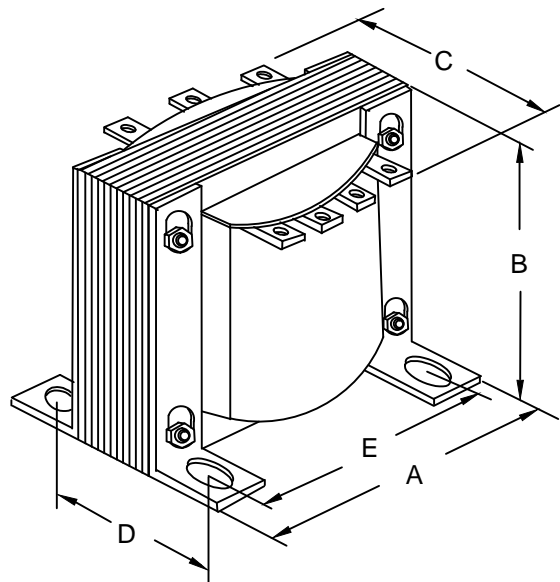

Notes: