

SPECIFICATION

NEXLEDS®

NEXLEDS LTD

ADJUSTABLE

LED Wall Pack

0-90°

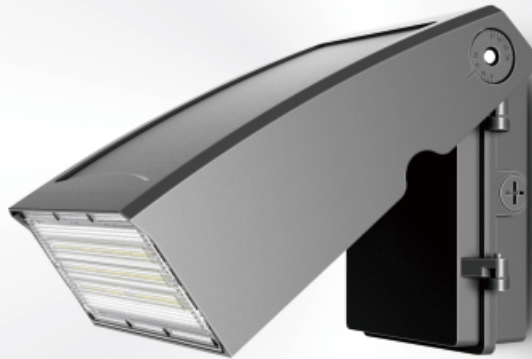

75W-60W-45W

3 WATT Choosable

3000K-4000K-5000K

3 CCT Choosable

Video

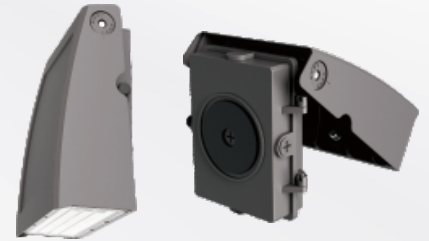

Adjustable LED Wall Pack

NX-FCWW-75WCS

Specification

Product Name :	Adjustable LED Wall Pack
Model NO. :	NX-FCWW-75WCS
Wattage :	75W / 60W / 45W Choosable
Specification :	AC120-347V; 50/60Hz; 900mA
Working Temp :	-40-50(°C)
Power Factor :	>0.9
CRI(ra) :	>80
Color :	Dark Bronze
Material :	Die-casting Aluminum
Light Source :	Lumileds2835
Lumen :	130 lm / W
Life Time :	50000 hrs
Beam Angle :	90 °
Adjustable Angle :	0-90 °
Product Size :	10.89x8.50x4.86 inch
IP :	IP65
Application :	General outdoor security lighting, pathways, loading docks, perimeters...etc
Warranty :	5 years
Standard :	UL, cUL, DLC, FCC
Color Temp :	3000K-4000K-5000K Choosable



www.nexleds.ca



Email: sales@nexleds.ca

NEXLEDS®

NEXLEDS LTD

Feature:

- Stylish slim profile design, available in black, white, bronze.
- 0-90° adjustable for semi and full cutoff application.
- Polycarbonate lens, anti-UV.
- Lumiled 2835 chips. 130lm/w @ 5000K (fixture)
- 120-347VAC, 12V output with 100mA.
- 0-10V dimming power supply.
- 3000K-4000K-5000K CCT selectable.
- Power selectable (75W-60W-45W).
- Photosensor optional.

Product Dimension

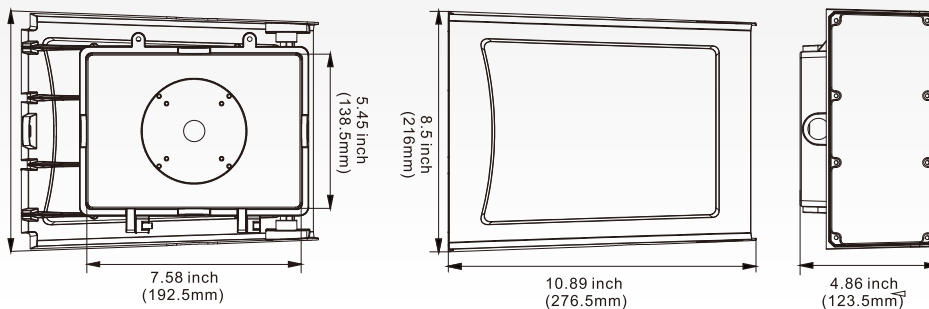

Installation Instructions:

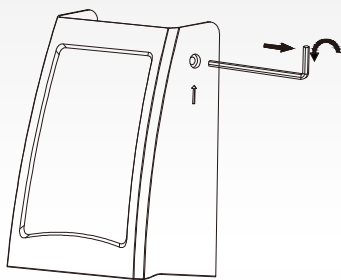

① Loosen the M6 Screw on the Fixture Housing.

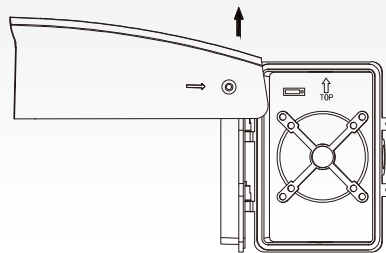

② Remove the Housing to install the Wall Mounting box.
a. Knock out appropriate holes when mounting to Junction Box(not provided)
b. Use the Level Bubble in the Wall Mounting Box, level the Fixture and secure to a sturdy wall. (shown as Fig3)

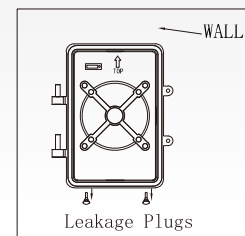

③ Place the Housing back to the Wall Mounting Box, and tighten the 2x M5 Flat Head Philips Screw. Remove Head Philips Screw. Remove the Leakage Plugs & check Door Gasket.

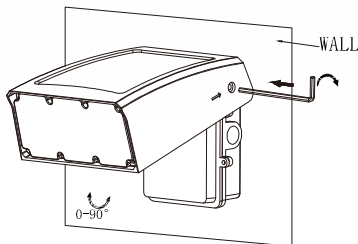

④ Adjust the Housing from 0-90° for desired beam angle via adjusting the M6 Screw.

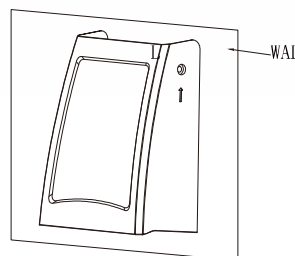

⑤ Connect the Fixture to main power.