

Saje[®]
NATURAL WELLNESS

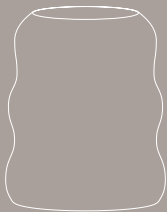

AROMA WAVE

ultrasonic diffuser
diffuseur ultrasonique

Please read and save this manual



A R O M A W A V E

ultrasonic diffuser

diffuseur ultrasonique



*Infuse your air with the vitality
and well-being of nature*

TABLE OF CONTENTS

| | |
|------------------------|----|
| BENEFITS OF DIFFUSING | 1 |
| PRODUCT FEATURES | 2 |
| SPECIFICATIONS | 3 |
| DIAGRAM OF PARTS | 5 |
| OPERATING INSTRUCTIONS | 6 |
| CARE & MAINTENANCE | 9 |
| CAUTIONS | 11 |
| FCC & IC STATEMENTS | 14 |
| FAQs | 16 |

BENEFITS OF DIFFUSING

Diffusing is an easy, heat-free way to enjoy Saje's 100% natural diffuser blends.

This ultrasonic technology, combined with water and essential oils, produces negative ions and aromas that elevate your well-being.

When used with your favorite Saje diffuser blend, the ultrasonic diffuser's refreshing mist brings nature's goodness into your space, supporting balance and harmony.

Transform your surroundings with revitalizing air that's reminiscent of fresh mist off a waterfall. Add the Saje diffuser blend of your choice and enjoy fresh, inviting aromas any time.

PRODUCT FEATURES

- Uses an ultrasonic, heat-free system to disperse essential oil molecules into the air.
- Gently humidifies your space.
- Whisper-quiet operation and auto shut-off.
- Continuous and intermittent mist settings.

SPECIFICATIONS

| | |
|----------------------------|-----------------------------------------------------------------------------------------------------------------------------------|
| PRODUCT NAME | Aroma Wave |
| INPUT VOLTAGE | AC220V |
| OUTPUT VOLTAGE | DC24V |
| RATING POWER | 12W |
| WATER TANK CAPACITY | 6.8 fl oz 200 ml |
| MISTING DURATION | approx. 6 hours continuous 12 hours intermittent |
| MIST OUTPUT | approx. 0.8 fl oz 25ml per hour on continuous (+/- 5ml); approx 0.4 fl oz 12.5 ml per hour on intermittent (+/- 5ml) |
| SETTINGS | mist continuous/ intermittent/off |
| COVERAGE AREA | approx. 500 sq ft |
| DIMENSIONS | approx. (D) 4.5" x (H) 9.0" or (D) 114 mm x (H) 229 mm |

| | |
|-----------------------|---------------------------------------------|
| NET WEIGHT | 44.3 oz 1257 g |
| MAIN MATERIALS | cover: cement; base: ABS; water tank: PP |

DIAGRAM OF PARTS

- A. MIST OUTLET
- B. CEMENT COVER
- C. WATER TANK COVER
- D. WATER TANK
- E. MAXIMUM WATER LEVEL LINE
- F. VENTILATION HOLE
- G. CERAMIC DISC
- H. BASE
- I. UNIT BOTTOM
- J. DC POWER JACK
- K. POWER ADAPTOR
- L. MIST POWER BUTTON

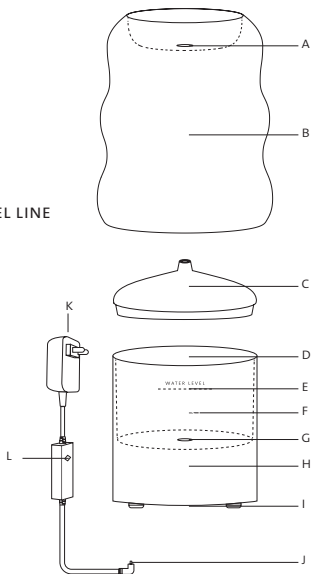

OPERATING INSTRUCTIONS

1. Remove the cement cover from the unit, then remove the water tank cover to expose the water tank.
2. Connect power adaptor to DC power jack underneath unit.
3. Fill water tank with room temperature tap water to no higher than max. water level line (6.8 fl oz | 200 ml) by bringing water to the unit.
4. Add 10-15 drops (depending on preference) of your favorite Saje diffuser blend to the water. Tilting the unit can cause water to run into the diffuser's ventilation system and out the bottom — to ensure correct usage, always bring water to your ultrasonic diffuser and not the other way around.

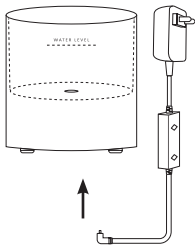
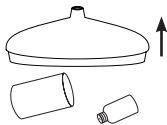
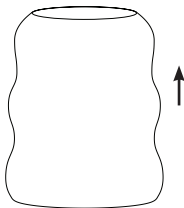

5. Replace the water tank cover and then the cement cover, ensuring that it fits properly onto the water tank and the base.
6. Plug power adaptor into electrical outlet.
7. Press the mist power button to turn the unit on. Press once to mist continuously, twice for intermittent and a third time to turn the unit off.

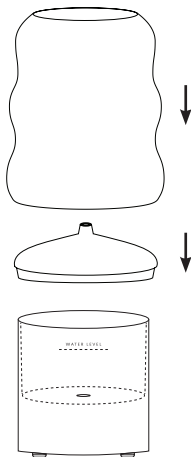

BUTTON INDICATORS:



press once:
Continuous mist



press a second time:
Intermittent mist



press a third time:
Off

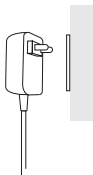

8. Unit will shut off automatically after 6 hours on continuous, or 12 hours on intermittent. Note that the water level remaining in the tank after shut-off will vary. For next use, fill up water level to the max. water level line with new water supply.
9. A filled unit should never be moved. Always wait until water reaches minimum levels to change diffuser's location; this will deter water from entering the ventilation system.
10. Use only Saje diffuser blends; other oils may contain fragrances, base oils or synthetics that could result in malfunction. Some single note essential oils are also too thick or heavy for use in the ultrasonic diffuser. See FAQs for more information.

PLEASE NOTE: RUN TIMES AND AMOUNT OF WATER LEFT IN THE TANK AFTER AUTO SHUT-OFF WILL VARY DUE TO CLIMATE, ENVIRONMENT AND OTHER FACTORS.

FOR OPTIMAL OPERATION, ENSURE MIST IS UNOBSTRUCTED BY OVERHANGING OBJECTS.

CARE & MAINTENANCE

- If the unit is knocked over while in operation, water could leak into the internal mechanism of the unit; if this occurs, unplug from power, empty water and let unit dry out in well-ventilated area for at least three days.
- Turn off unit and unplug from the power adaptor prior to cleaning.
- Remove cover and empty water from the water tank, carefully avoiding the air outlet.
- To clean exterior of unit, wipe outer lid with a dry cloth. Do not allow essential oils to spill on outer lid.
- Clean inner lid with a damp cloth. Do not submerge or wash entire lid under water.
- If required, use a clean, soft, damp cloth to wipe down exterior of unit.
- If oils are spilled on the diffuser's surface, clean immediately to prevent surface damage.

- Frequency of necessary water tank cleaning is dependent upon usage and types of diffuser blends used (i.e. how thick the essential oils are in the diffuser blend).
- To clean inside water tank, pour a few drops of rubbing alcohol into tank and wipe with a clean, soft cloth.
- To clean the disc, pour a few drops of rubbing alcohol onto a clean cotton swab and wipe the disc. The disc can be accessed by inserting the swab in the hole at the center/bottom of the water tank. Repeat this process with a new cotton swab until the cotton swab comes out clean.
- The ceramic disc should be kept clean of mineral deposits and other debris for optimal misting. Never use any sharp objects to clean the ceramic disc as this will damage the disc permanently.
- For optimum results, clean the water tank before changing diffuser blends.
- Do not disassemble or attempt to repair unit; in the event of a problem, please contact 1-877-ASK-SAJE.

CAUTIONS

- Only use the power adaptor supplied with the device. Never operate the device if the power adaptor is damaged.
- Do not attempt to use the device if any part is damaged or broken.
- To reduce the risk of electric shock: do not attempt to service the device in any way other than as described in the “Care & Maintenance” section of this manual; do not plug the unit into the wall socket with wet hands. In case of smoke, unusual aromas, noises or other malfunctions, unplug the unit immediately and discontinue use.
- Do not place unit directly below or beside electrical outlets or other electrical devices that are susceptible to water damage.
- Do not place the unit on carpet or fabric surfaces that may obstruct the fan on the bottom of the unit, causing overheating.

- When moving the device, hold securely by the base. Always place the unit on a stable, level surface. Do not tilt, move or attempt to empty or refill unit while in use.
- Do not touch the highly sensitive ceramic disc with bare fingers when the ultrasonic diffuser is in use or plugged in. To prevent clogging or damaging the ceramic disc when operating, use clean tap water at room temperature.
- Do not fill water tank directly from tap as water could spill into the internal mechanism and cause damage. Fill only to the water level line and do not overfill or immerse the unit in water.
- Do not pour water or other liquid into the air outlet. Ensure that no essential oils or water leak into the air outlets on either side of the water tank. After each use, remove any liquid left in the water tank.
- Always turn off and unplug the device during maintenance or when not in use. Ensure that the power adaptor is not covered or blocked when

plugged in; it must be able to dissipate the heat properly.

- Never leave diffuser unattended while turned on, especially in children's rooms. Keep device out of child's reach
- Use only Saje diffuser blends in device: other oils may contain fragrances, base oils or synthetics that could result in malfunction. Some single note essential oils are also too thick or heavy for use in the ultrasonic diffuser. See FAQs for more information.
- Always keep unit out of reach of small children and pets.
- Lid is made of fragile materials and can be easily scuffed or damaged if dropped. Handle with care.

FCC & IC STATEMENTS

This device complies with Part 15 of the FCC rules. Operation is subject to the following two conditions:

- 1) This device may not cause harmful interference, and
- 2) This device must accept any interference received, including interference that may cause undesired operation.

This equipment has been tested and found to comply with the limits for a Class B digital device, pursuant to part 15 of the FCC Rules. These limits are designed to provide reasonable protection against harmful interference in a residential installation. This equipment generates, uses and can radiate radio frequency energy and, if not installed and used in accordance with the instructions, may cause harmful interference to radio communications. However, there is no guarantee that interference will not occur in a particular installation. If this equipment does cause harmful interference to radio or television reception,

which can be determined by turning the equipment off and on, the user is encouraged to try to correct the interference by one or more of the following measures:

- Reorient or relocate the receiving antenna.
- Increase the separation between the equipment and receiver.
- Connect the equipment into an outlet on a circuit different from that to which the receiver is connected.
- Consult the dealer or an experienced radio/TV technician for help.

Changes or modifications not expressly approved by Saje Natural Wellness Canada could void the user's authority to operate this equipment. This device complies with Part 18 of the FCC Rules and ICES 001. Although this product is tested and complies with FCC, it may interfere with other devices. If this product is found to interfere with another device, separate the other device and this product. Conduct only the user maintenance found in this instruction manual. Other maintenance and servicing may cause harmful interference and can void the required FCC compliance.

FAQs

Q: WHAT IF MY UNIT DOES NOT TURN ON?

The power adaptor may not be properly plugged in; ensure that the power adaptor is properly plugged into the DC power jack and the electrical source.

Q: WHAT IF MY UNIT DOES NOT MIST OR THERE IS ALMOST NO MIST?

- A. There may not be enough water in the water tank; ensure that the water tank is filled to the maximum water level line.

- B. The water level may be too high (higher than the maximum water level line); turn off unit, pour out excess water and try again.

- c. The ceramic disc may require cleaning. Please see “Care & Maintenance” instructions.

Q: WHAT TYPE OF WATER SHOULD GO INTO MY ULTRASONIC DIFFUSER?

To prevent clogging or damage to the unit or disc, it's recommended to use clean tap water at room temperature.

Q: WHAT CAN I PUT IN MY ULTRASONIC DIFFUSER?

We recommend using 100% natural Saje diffuser blends, as they have been carefully blended for safe and easy use in your ultrasonic diffuser. Other blends and oils may contain fragrances, base oils or synthetics that have a thick and heavy consistency and could result in your unit's malfunction.

All Saje 100% Pure Single Note Essential Oils may be diffused, except the following:

- Ylang Ylang
- Patchouli
- Sandalwood
- Jasmine
- Rose

Imported and distributed by / Importé et distribué par :

SAJE NATURAL WELLNESS

22 EAST 5TH AVE VANCOUVER, BC CANADA

V5T 1G8 | SAJE.COM | 1-877-ASK-SAJE | @SAJEWELLNESS

MADE BY OUR FRIENDS IN CHINA. FABRIQUÉ EN CHINE

I'M MADE FROM RECYCLED PAPER. *please recycle where possible*