

ASSEMBLY INSTRUCTION

1

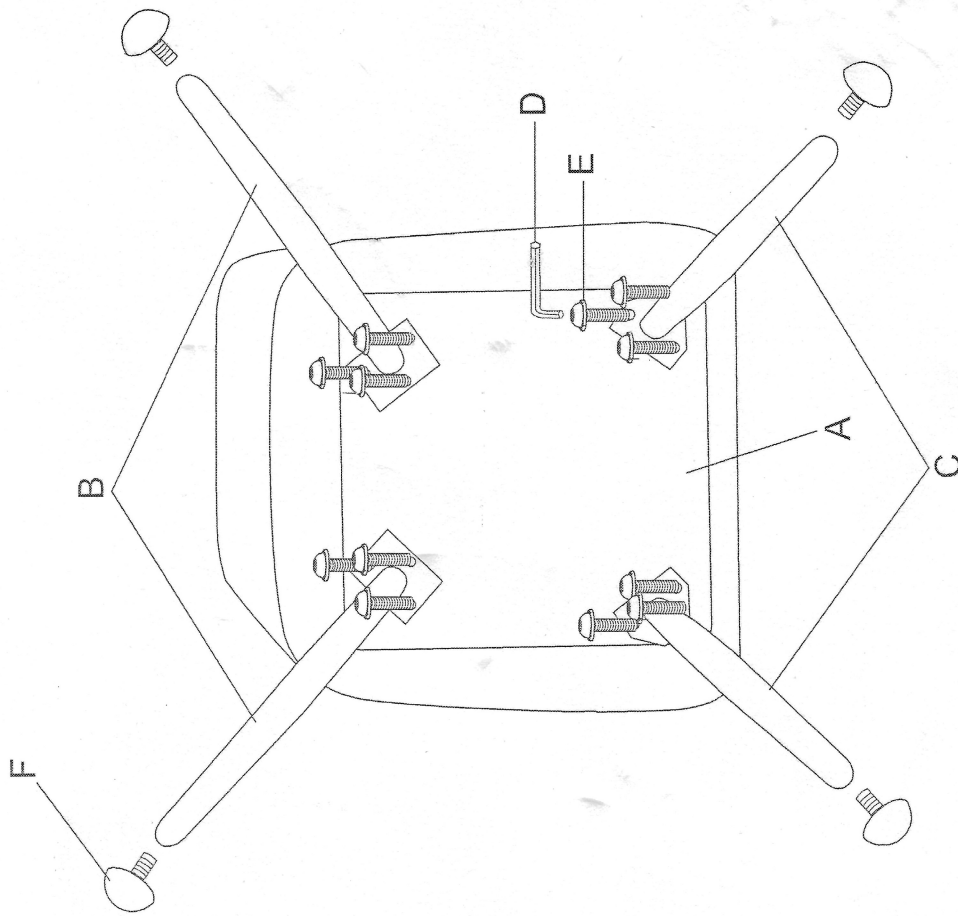

2

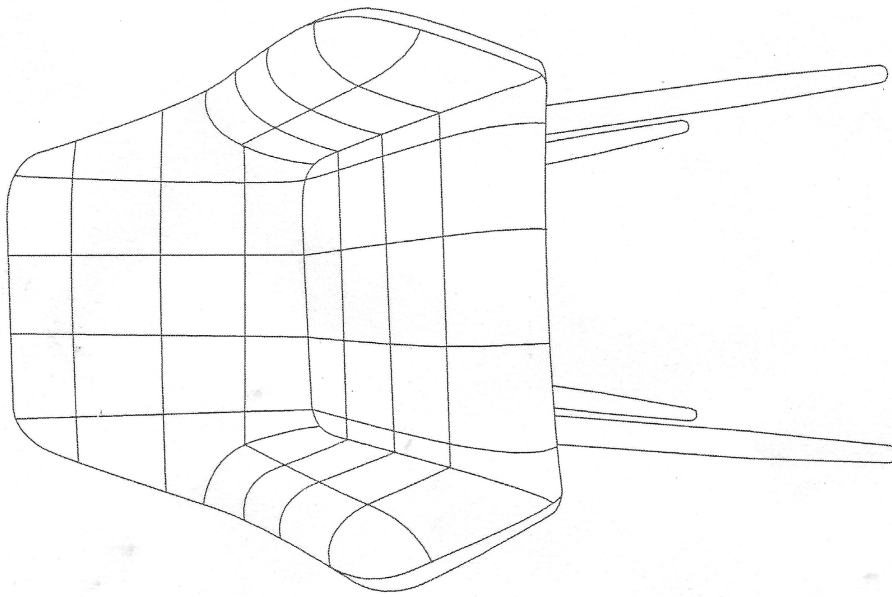

AX1

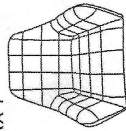

Bx2 (Back Leg)

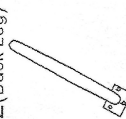

Cx2 (Front Leg)

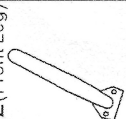

Dx1

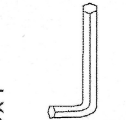

Ex12

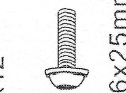

M6x25mm

Fx4

