



# POWERSHRED®

## 425Ci/425i/485Ci/485i

THE WORLD'S **TOUGHEST** SHREDDERS™



Please read these instructions before use.  
Do not discard: keep for future reference.

**Fellowes**

Quality Office Products Since 1917

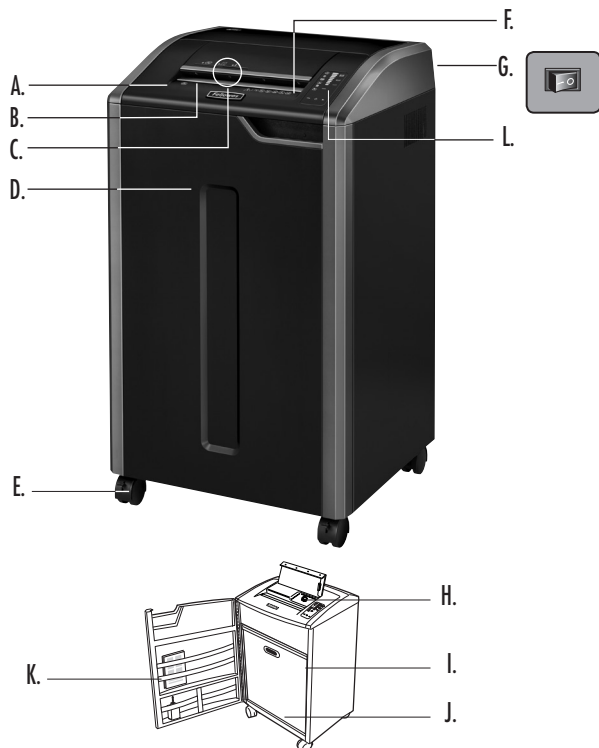

### KEY

- |   |   |
|---|---|
| A. SafeSense® Technology                                  | L. Control panel  |
| B. Paper entry  | 1. Sheet capacity indicator                               |
| C. CD, credit card and junk mail entry                    | 2. Low oil indicator (red)<br><i>425Ci and 485Ci only</i> |
| D. Door   | 3. Bin full (red)   |
| E. Casters  | 4. SafeSense® (yellow)                                    |
| F. See safety instructions                                | 5. Remove paper (red)                                     |
| G. Disconnect power switch                                | 6. Door open (red)  |
| H. Oil reservoir  | 7. Straight feed (red)                                    |
| I. Oil drain plug (inside)<br><i>425Ci and 485Ci only</i> | 8. Auto button  |
| J. Basket   | 9. Reverse  |
| K. Accessory tray   | 10. ON/OFF  |
|   | 11. Forward   |

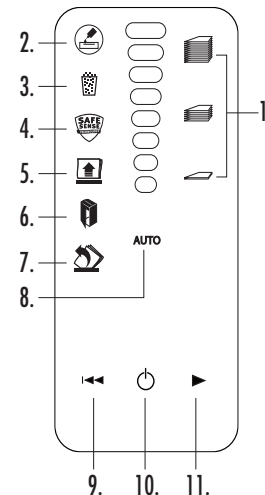

## CAPABILITIES

**Will shred:** Paper, 132 column continuous form, credit cards, CD/DVDs, staples, paper clips and junk mail

**Will not shred:** Adhesive labels, transparencies, newspaper, cardboard, large paper clips, laminates, file folders, X-rays or plastic other than noted above

**Paper shred size:**

Cross-Cut (425Ci, 485Ci).....5/32 in. x 1-1/8 in. (3.9mm x 30mm)  
Strip-Cut (425i, 485i).....1/4 in. (5.8mm)

**Maximum:**

Sheets per pass (Cross-cut)..... 28\*  
Sheets per pass (Strip-cut) ..... 38\*  
CDs/Cards per pass ..... 1\*  
Paper entry width (485Ci, 485i) ..... 16 in. (407mm)  
Paper entry width (425Ci, 425i) ..... 12 in. (305mm)

\*8.5"x11", 20lb., (75g) paper at 120V, 60 Hz, 12Amps; heavier paper, humidity or other than rated voltage may reduce capacity. Recommended daily usage rates: 10,000 sheets per day, 500 credit cards; 50 CDs.

Follows SafeSense® shredders are designed to be operated in office environments ranging between 50 – 80 degrees Fahrenheit (10 – 26 degrees Celsius) and 40 – 80% relative humidity.

## ⚠ WARNING: IMPORTANT SAFETY INSTRUCTIONS — Read Before Using!



- Keep away from children and pets. Keep hands away from paper entry. Always set to off or unplug when not in use.
- Keep foreign objects – gloves, jewelry, clothing, hair, etc. – away from shredder openings. If object enters top opening, switch to Reverse (←) to back out object.
- Never use aerosol products, petroleum based lubricants or other flammable products on or near shredder. Do not use canned air on shredder.
- Do not use if damaged or defective. Do not disassemble shredder. Do not place near or over heat source or water.
- Operation, maintenance, and service requirements are covered in the instruction manual. Read the entire instruction manual before operating shredders.

- This shredder has a Disconnect Power Switch (G) that must be in the ON (I) position to operate shredder. In case of emergency, move switch to OFF (O) position. This action will stop shredder immediately.
- Avoid touching exposed cutting blades under shredder head.
- Use only designated entry for CDs/cards. Keep fingers away from CD entry.
- Do not put foreign objects in paper entry.
- Shredder must be plugged into a properly grounded wall outlet or socket of the voltage and amperage designated on the label. The grounded outlet or socket must be installed near the equipment and easily accessible. Energy converters, transformers, or extension cords should not be used with this product.
- FIRE HAZARD – Do NOT shred greeting cards with sound chips or batteries.
- For indoor use only.
- Unplug shredder before cleaning or servicing.

## BASIC SHREDDING OPERATION

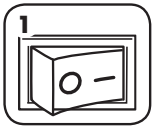

1 Plug in and put disconnect power switch in ON (I) position

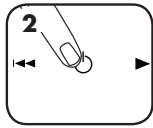

2 Press (ON/OFF) button to activate (blue)

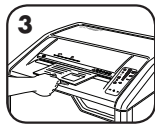

3 Feed paper into paper entry and release



4 Feed CD, credit card or junk mail into designated entry and release

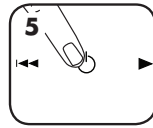

5 Set to Off (O) or shredder will automatically go into sleep mode after 2 minutes of inactivity

## ADVANCED PRODUCT FEATURES



**Jam Proof System**  
Eliminates paper jams and powers through tough jobs.



**Auto Oil™**  
Lubricates the cutters automatically to enhance performance and extend shredder life.



**Patented SafeSense® Technology**  
Automatically stops when hands touch the paper opening.



**Energy Saving System**  
Reduces energy consumption by up to 70%.\*

\*Compared to conventional shredders during normal usage.



## JAM PROOF SYSTEM OPERATION\*

Eliminates paper jams and powers through tough jobs.

1 Advanced Jam Prevention- Electronically measures paper thickness to prevent paper jams:

Up to RED: Too many sheets have been inserted.

Up to YELLOW: Productivity is optimized.

Up to GREEN: More sheets can be added.

2 Remove several sheets until indicator is below red.

3 Continue 100% Jam Proof Shredding



If a misfeed occurs: All indicators light up and shredder pauses for 3-6 seconds

Wait for flashing to stop after automatic correction is complete. Regular shredding will resume.

If illuminates after paper has been reversed, press reverse and remove paper. Otherwise, regular shredding will resume.

## STRAIGHT FEED



If Straight Feed indicator illuminates, remove paper and feed straight into shredder.

\*100% Jam Proof when used in accordance with user manual

## AUTO OIL™ OPERATION

Lubricates the cutters automatically to enhance performance and extend shredder life  
(Auto oil system is only included on cross-cut models - 425Ci and 485Ci.)

### SET-UP AND TESTING

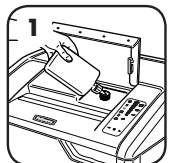

1 Before using, fill oil reservoir with 12 oz. (355 ml.) of Fellowes shredder oil



2 Press the auto and forward buttons at the same time for 3 seconds to manually oil shredder

### REFILLING OIL

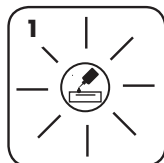

1 Low oil indicator will signal when your reservoir needs refilling

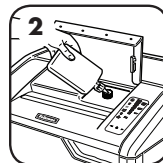

2 To maintain shredder performance, refill oil reservoir with up to 12 oz. (355 ml.) of shredder oil (Fellowes #35250)



3 Once refilled, automatic oiling will resume

## ADVANCED PRODUCT FEATURES



### SAFESENSE® TECHNOLOGY OPERATION

Automatically stops when hands touch the paper opening.

#### SET-UP AND TESTING

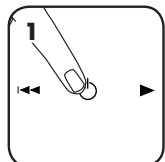

1 Turn the shredder on to activate SafeSense®

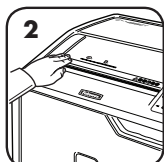

2 Touch test area and look for the SafeSense® indicator to illuminate

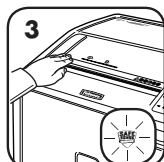

3 SafeSense® is active and working properly



### SLEEP MODE OPERATION

Energy saving feature shuts down the shredder after 2 minutes of inactivity

#### WHEN IN SLEEP MODE



1 In sleep mode

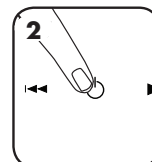

2 To get out of sleep mode or insert paper touch control panel

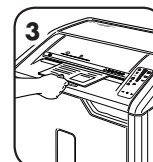

3 insert paper

## PRODUCT MAINTENANCE

### CLEANING AUTO-START INFRARED SENSORS

Paper detection sensors are designed for maintenance free operation. However, on rare occasions, the sensors may become blocked by paper dust causing the motor to run even if there is no paper present. (Note: two paper detection sensors are located in the center of the paper entry.)

#### TO CLEAN THE SENSORS

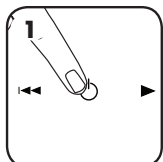

1 Turn off and unplug shredder

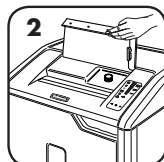

2 Lift CD flap



3 Locate Auto-start infrared sensor

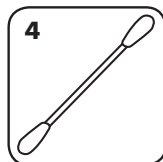

4 Dip cotton swab in rubbing alcohol



5 Using cotton swab, wipe away any contamination from the paper sensors

### AUTO OIL™

Automatically oils the cutters to enhance performance and extend shredder life. (Auto oil system is only included on cross-cut models - 425Ci and 485Ci)

#### REFILLING THE OIL

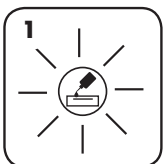

1 Low oil indicator will signal when your reservoir needs refilling

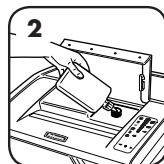

2 To maintain shredder performance, refill oil reservoir with up to 12 oz. (355 ml.) of shredder oil (Fellowes 35250)



3 Once refilled, automatic oiling will resume

- All cross-cut shredders require oil for peak performance. If not oiled, a machine may experience diminished sheet capacity, intrusive noise when shredding and could ultimately stop running. We recommend that you refill the Auto Oil™ reservoir as instructed for optimum performance.
- If shipping shredder, oil must be drained. Open cabinet door and remove basket to access oil drain plug. Place suitable container under drain, remove plug and let oil drain out. Replace plug.

## TROUBLESHOOTING



**Low Oil Indicator:** When illuminated, the shredder is out of oil and needs to be refilled. See the Product Maintenance section for refill instructions. For optimum performance, use Fellowes oil (35250). \*Auto Oil™ is only featured on cross cut models – 425Ci and 485Ci.



**Bin Full Indicator:** When illuminated, the shredder waste bin is full and needs to be emptied. Use Fellowes waste bag 3605801.



**SafeSense® Indicator:** If hands are too close to the paper entry, the SafeSense® indicator will illuminate and the shredder will stop shredding. If SafeSense® is active for 3 seconds, the shredder will automatically turn off and the user must press the power button on the control panel to resume shredding.



**Remove Paper Indicator:** When illuminated, press reverse (←) and remove paper. Reduce paper quantity to an acceptable amount and refeed into paper entry.



**Door Open Indicator:** The shredder will not run if the cabinet door is open. When illuminated, close the door to resume shredding.



**Straight Feed Indicator:** When illuminated, remove paper and feed straight into paper entry.



### JAM PROOF SYSTEM\*

Eliminates paper jams and powers through tough jobs.

#### DISABLING THE FEATURE



Should you choose to disable the system, press and hold the auto and reverse (←) buttons at the same time

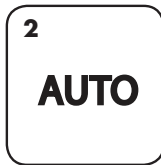

Once disabled, the blue Auto light is no longer illuminated (To re-engage, repeat step 1)

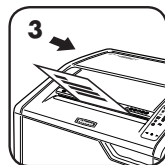

Shredding can continue with the system disabled; however, a paper jam may occur with too many sheets and Remove Paper icon (↑) will illuminate

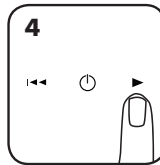

If jam occurs, press and hold forward (→) button until the document is completely through the shredder

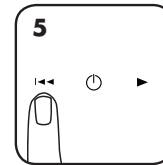

If not cleared, press reverse (←) briefly (repeat steps 4 and 5 until shredded)

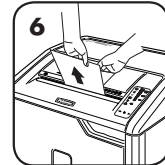

If steps 4 and 5 do not clear jam, reverse paper all the way out, remove several sheets and refeed

\*100% Jam Proof when used in accordance with user manual

## LIMITED PRODUCT WARRANTY

Limited Warranty: Fellowes, Inc. ("Fellowes") warrants the parts of the machine to be free of defects in material and workmanship and provides service and support for 2 years from the date of purchase by the original consumer. Fellowes warrants the cutting blades of the machine to be free from defects in material and workmanship for the lifetime of the shredder. If any part is found to be defective during the warranty period, your sole and exclusive remedy will be repair or replacement, at Fellowes' option and expense, of the defective part. This warranty does not apply in cases of abuse, mishandling, failure to comply with product usage standards, shredder operation using an improper power supply (other than listed on the label), or unauthorized repair. Fellowes reserves the right to

charge the consumers for any additional costs incurred by Fellowes to provide parts or services outside of the country where the shredder is initially sold by an authorized reseller. ANY IMPLIED WARRANTY, INCLUDING THAT OF MERCHANTABILITY OR FITNESS FOR A PARTICULAR PURPOSE, IS HEREBY LIMITED IN DURATION TO THE APPROPRIATE WARRANTY PERIOD SET FORTH ABOVE. In no event shall Fellowes be liable for any consequential or incidental damages attributable to this product. This warranty gives you specific legal rights. The duration, terms, and conditions of this warranty are valid worldwide, except where different limitations, restrictions, or conditions may be required by local law. For more details or to obtain service under this warranty, please contact us or your dealer.



# POWERSHRED®

## 425Ci/425i/485Ci/485i

THE WORLD'S **TOUGHEST** SHREDDERS™

### Questions or Concerns?

---

#### www.fellowes.com

- Troubleshooting
- Registration
- Manuals

#### Customer Service & Support

- Troubleshooting
- Replacement parts
- General questions

---

Canada	+1-800-665-4339
Mexico	+1-800-234-1185
United States	+1-800-955-0959