

# USER MANUAL

PLEASE READ THE INSTRUCTIONS CAREFULLY BEFORE RIDING

# MUKUTA



 TEMPERATURE CONTROL

---

 NFC

---

 SINGLE MOTOR

---

 MECH DISC BRAKE

---

# CONTENT

GENERAL INFORMATION.....	1
MUKUTA RANGE-CONTROL LAYOUT, FUNCTIONS AND SPECIFICATIONS.....	2~3
INTELLIGENT TEMPERATURE CONTROL MANAGEMENT SYSTEM.....	4~5
MUKUTA DISPLAY OPERATION AND PROGRAMMING .....	6~15
FOLDING HANDLE BARS.....	16~17
BATTERY REMOVAL .....	18~19
ADJUSTING THE SUSPENSION .....	20
BATTERY AND CHARGING .....	21~22
PRE RIDE CHECKS .....	23
WARNING .....	24
LIMITED WARRANTY .....	25
ERROR CODES.....	26~27
INCLUDED IN THE BOX.....	28
AFTER-SALES SERVICE.....	29~31

# READ THIS MANUAL BEFORE USING

## IMPORTANT INFORMATION

### WHY IS IT NECESSARY TO READ THIS MANUAL BEFORE OPERATING?

This manual was written to help you understand the proper use and maintenance of the MUKUTA line of Electric Scooters.

It is important to understand the functions and features of the new MUKUTA before operating it as it will allow you to enjoy the most of it from the first and every ride.

It is also important for you to note that the first trial of the MUKUTA should be in a remote area where obstacles are minimal to none.

The MUKUTA unit will require some adjustments and a break-in period for all moving parts to adjust themselves into the correct position.

**BEFORE RIDING:** Please ensure that the folding mechanism is firmly locked in place and that the safety lock is engaged.



## DISCLAIMER & WARNING

The product and its brand MUKUTA are not liable for any accidental damages related to the usage of this product.

### **WARNING!**

The responsibility for MUKUTA maintenance is yours! Proper and frequent maintenance will reduce the risks of injuries.

- ALWAYS WEAR A HELMET WHEN RIDING
- ALWAYS FOLLOW LOCAL LAWS AND REGULATIONS
- NEVER RIDE THE SCOOTER IN POOR VISIBILITY
- DO NOT DO STUNTS, WHEELIES or JUMPS IF YOU DO NOT HAVE THE PROPER SAFETY GEARS.

# MUKUTA



- MAX SPEED: 38kmh
- ELECTRONIC BRAKE + MECH DISC BRAKE SYSTEM



- CONTROLLER: 48 V (23A)  
MAX RANGE:  
• SINGLE DRIVE 70km
- BATTERY: 48V 15.6Ah



- MECHANICAL BRAKE LEVERS
- NFC KEY LOCK
- ELECTRONIC HORN



- FOLDING SWITCH



- 600W REAR MOTOR
- ADJUSTABLE TWIST SUSPENSION
- 8 INCH SOLID TIRE
- REAR DISC BRAKE



- FRONT DISC BRAKE
- 600W FRONT MOTOR
- ADJUSTABLE TWIST SUSPENSION



---

Model	MUKUTA 8
Battery	48V 15.6Ah
Tire	8 INCH SOLID TIRE
Brakes	ELECTRIC BRAKE+FRONT AND REAR MECH DISC BRAKES
Max Range (Single Motor)	70km
Max Speed	38kmh
Weight	30kg
Suspension	ADJUSTABLE TWIST SUSPENSION
Motor Power	48V 600W BRUSHLESS MOTORS
Controller	48V (23A)
Max Load	120KG

---



Maximum load and speed may vary depending on the rider's weight, riding style and terrain.



## INTELLIGENT TEMPERATURE CONTROL MANAGEMENT SYSTEM

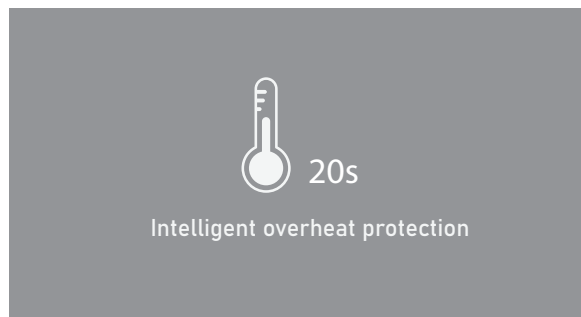

The motor controller/s fitted to your MUKUTA electric scooter feature overload protection. Should the controller temperature exceed the safety threshold, the management system will enter a 20s protection cycle. Should you experience a loss of power due to overload, please stop riding and allow the controller time to cool.



## MUKUTA series electric scooter intelligent temperature control system

(A 165LB load was tested according to the summer climate)

<b>Model</b>	MUKUTA 8
<b>Protection temperature</b> (According to the local topography $\pm$ 5°C)	100°C
<b>Protection time</b> (According to local climatic conditions $\pm$ 5s)	20s



## Basic operation:

### 1、 Function

#### 1. Displayed content

Speedometer / Voltage level / Odometer / Trip meter / Battery level / Cruise-control active light / Gear indicator / Fault warning light

#### 2. All content on display(power on within 1 second)

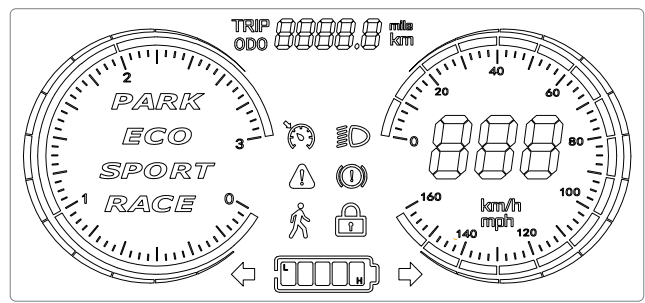



3.1 Speed display area

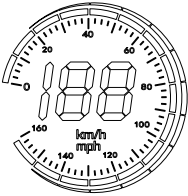

Unit: MPH, KM/H

The speed signal is taken from the Hall signal inside the motor. Sent to the controller by controller(Time of single Hall period,unit:1MS). The display calculate the true speed based on wheel diameter and signal data calculate the true speed(The motor Holzer also needs to set the number of magnetic steel)

3.2 Vehicle power gear adjustment,



PARK,ECO,SPORT,RACE digital display

3.3 vehicle status display area



Brake power off reminder;



The headlight turns on the prompt;



Constant speed cruise hint;



Communication fault prompt;







Pedestrian Mode;



Battery lock prompt;

Display P-Codes(programming codes)

To access this menu, long-press . Use  button to scroll through P-codes,  and  to change parameters

P01: Battery lock, 0 means locked, 1 means unlocked.

P02: Mileage: unit, 0: KM; 1: MILE; Default: KM

P03: Voltage level: 24V, 36V, 48V, 52V, 60V, 72V, Default:48V

P04: Dormancy time: 0 means no dormancy; Other numbers are dormant time. The range is 1-60 minute. Default:5

P05: Reserve

P06: Wheel diameter: The unit is the inch. The accuracy is 0.1; Default:8

P07: Speed measuring magnetic steel number.The range is 0-255. Default:28

P08: Rate-limiting: The range is 0-100km/h.Default: 100

P09: Zero start- no zero start setting; 0 means zero starts. 1 means no Zero starts. Default: 0

P10: Reserve

P11: EABS switch choose. The range is 1-5.0 means closing. 1 means weakest. 5 means strongest.

P12: Soft and hard start strength. The range is 1-5. The softest is 1. The hardest is 5. Default: 5



P13: Reserve

P14: Reserve

P15: Controller under-voltage

P16: ODO Zero setting: keep pressing + for 5 seconds, and ODO will zero clearing.

P17: When it shows 0, it can not use cruise. When it shows 1, it can use cruise.Default:0











P18: Bind and unbind NFC CARDS.Long press  to build the binding, long press  to build the unbinding

P19: Backlight brightness: The 1 level is the darkest, Level 3 brightest; Default: 3

P20: Communication protocol is default 4. It can not change.

## 2、 Introduction of buttons and interfaces



1. When it is shut down, long-press hold button continuously for 2s  to turn on the power. When it is powered on ,It can change interface between the ODO、 TRIP、 VOL, by pressing  for a short time.
2. When it is powered on, long-press hold button continuously for 2s  to turn off, press   to change gear.
3. Long-press  to enter P-code menu - refer to functions on page 8.  
Enter the menu setting interface, press  or  to increase or decrease the value , after the modification is finished;Press  to switch to the next parameter and save the value of the previous parameter;After parameter modification, long press  again to exit the setting interface, or wait for 8 seconds for automatic exit and save parameters.

## 3、 Card binding instructions

1.The instrument is not bound to NFC card:

After starting up, the LCD displays the normal contents, At this time, the meter can directly enter the working state.

The diagram below:



2.How to bind NFC card:

CARDS are bound by factory default

Late setting: When using a mobile phone or NFC functional card binding, refer to the following methods

Long press  for 5 seconds to display B 0. At this time, the NFC card is close to the card swiping area and B 1 is displayed, indicating that the card is tied successfully and the default is unlimited.

Press  for 5 seconds to display C 0. At this time, all NFC cards that have been unbound are displayed.

3. The instrument has been bound with NFC card: after starting up, the LCD displays card, the power voltage is not displayed in the card swiping area, and the swiping indicator flashes, indicating that the card needs to be swiped to start up. At this time, the accelerator does not work.

The diagram below:



**Note:** Due to the upgrade of the company's products, some of the displayed contents of the products you get may be different from the instructions, but it will not affect your normal use.

If the NFC cards are lost accidentally, you can try to contact the local agents. (each E-Scooter is equipped with 3 keys).



- |                                   |                                  |
|-----------------------------------|----------------------------------|
| 1. Power switch                   | 7. Toggle Switch for Turn signal |
| 2. Menu button                    | 8. Rear brake                    |
| 3. Toggle Switch for gear change. | 9. Handle folding mechanism      |
| 4. Front brake                    | 10. Displayer                    |
| 5. Speed handlebar                | 11. NFC card swiping area        |
| 6. Electric hooter                |                                  |

Power On/Off	Long-press the power button [1] for 2 seconds to turn on/off the scooter, then use NFC card to activate it. The scooter turns off automatically if not used for 90 seconds
Speed Control	Push the [3] Switch to cycle through the three different speed levels ECO to RACE .Use the [5] throttle to control the speed within each speed level.
Headlight	While power is on, push up (push and hold for 2s) [3] Switch to turn on or off headlight.
Mileage & Other data	While stationary, and with the power on, Long-press(press and hold for 2s) and release the [1] button to cycle through the following data: ODO (lifetime mileage),TRIP mileage, VOLTAGE level and ERROR CODE.

## TURNING IT ON

Press the  for 3 seconds and wait to be prompted for the Token (Card).

Tap the Token (Card)  to the IR reader NFC



---

## P-SETTING

Press and hold  simultaneously for 3 seconds to access the P Setting interface.

---

## CHANGING OF SPEED

Press the  once or the  to toggle between increasing between ECO to RACE.

Function is to limit max limit, RACE being the max speed able to achieve.



## UNLOCK THROTTLE MISAPPLICATION MODE

In the power-on state, the menu is displayed as Park-code by default. At this time, the scooter is locked and cannot be ridden, that is, the throttle misapplication mode; Pull  up, switch the Park-code to any one of the Eco-code, Sport-code, or Race-code, can unlock the throttle misapplication mode, and ride normally; If no operation is performed within 30 seconds, it will automatically switch to Park-code and activate throttle misapplication mode.

---

## Unlock Walk Assist Mode

In the power-on state, after unlocking the P-code, that is, unlocking the throttle misapplication mode, and long press  down to activate the walk assist mode.

# Folding handle bar

1

Turn the handle screw anti - clockwise to loose the mechanism



2

Once loosen, pull the screw catch away from each other



3

Simultaneously fold the handle bar down



4

Loosen the folding buckle



5

Take out the hook



6

Fold down the main pole



7

Snap the handlebar's safety hook into the rear shim

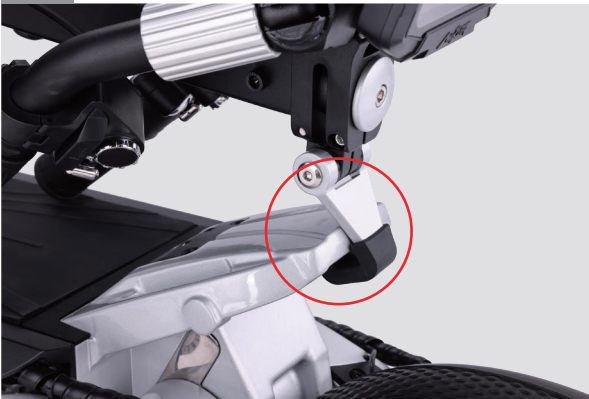

# Battery Removal

1

Press and hold the M to access the settings interface.



2

P01 will display 0, indicating that the battery is currently locked.



3

Push the aviation-style button on the right upwards to set the P01 to 1, indicating that the battery is unlocked.



4

Press and hold the power button to turn off  
*(Please note that the battery can only be removed when the scooter is turned off.)*



5

After shutting down, wait for 2 seconds for the battery to complete the unlocking process, then gently pull it out.



6

Once the battery is inserted back into the scooter, it will automatically lock after 2 seconds, allowing you to power on the scooter for normal use.



# Adjusting the suspension

1 Rotate the rear suspension to the left to tighten it.



2 Rotate the rear suspension to the right to release it.



3 Rotate the front suspension to the left to tighten it.



4 Rotate the front suspension to the right to release it.



## BATTERY

- Do not operate the scooter while charging
- Do not store the scooter over a long period of time with an almost empty battery.
- From time to time, discharge the battery by riding. Have the battery recharge again and make sure to not leave battery fully empty.

## DISABLE CHARGING IN THE FOLLOWING CIRCUMSTANCES:

- Is broken
- Emits an unusual odour or colorless liquid.
- The bottom of the deck or it as a whole gets into excessive heating
- Leakage is present.

Avoid contacting with substances or meddling with a bloated battery. Keep the battery away from children, pets or direct heat. Exposure to the battery voltage may cause death or serious injury.

The use, storage or charging of the MUKUTA battery outside specified limits may result in the annulment of the warranty, battery damage and an effective battery charging.



It is important to fully charge the battery before your first use of the scooter.

### First Charge

---

Your scooter's battery comes with these built-in features:

1. Balanced charging protection: During charging, the battery automatically balances the voltage among the internal cells to protect each cell.
  2. Over-charging protection: The battery stops charging automatically when full to protect against damage.
  3. Over-current protection: The battery automatically stops charging if the voltage is higher than prescribed voltage to protect the battery.
  4. Over-discharging protection: The battery automatically stops discharging when its voltage drops below Under voltage value to protect the battery.
  5. Short-circuit protection: the battery automatically stops output in the case of a short-circuit.
- 

### How to charge

1. Ensure that scooter is TURNED OFF. Connect external power charger to scooter.
2. Connect charger to electrical outlet, then turn on the power of electrical outlet.
3. Do not charge the batteries in temperatures below 5 °C or above 40 °C. The battery may stop the charging process.
4. Charging Light **RED** - Battery is charging.  
Charging Light **Green** - Battery is fully charged.



# PRE RIDE CHECKS

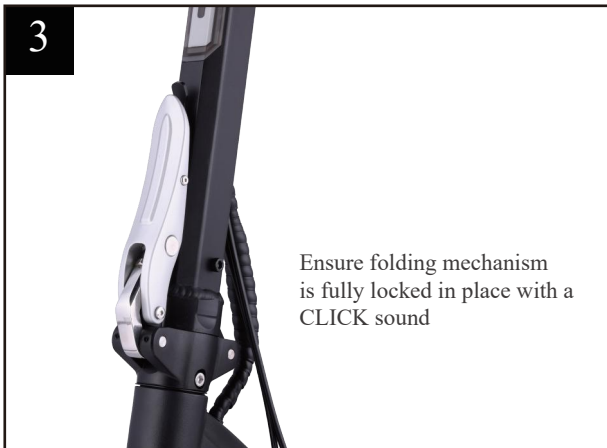



## WARNING!

Certain countries or regions require safety devices or gear. It is your responsibility to know the state laws and follow them. However, we strongly recommend using safety equipment correctly before riding scooter.

### SAFETY GEAR

Helmet: Most common and serious injuries from riding are head injuries. This can be prevented by adorning a helmet. You must wear a helmet when riding the MUKUTA. The helmet must be worn according to their instruction.

### MECHANICAL SAFETY

Before using the MUKUTA:

- 1) Always perform a visual inspection of all screws and nuts are tight and in place. If anything is amiss or missing and you are unsure, please bring it back to the authorized distributor or contact us via email.
- 2) Check the tires and wheels and that it is not showing signs of wear and tear; not in need of replacement. Always ensure that the brake mechanism is not touching the wheels and allows free spinning.
- 3) Always perform mechanical checks of brakes and other parts of the scooter that allows visibility, safety and functionality of the scooter.

**Disclaimer:**

1. The customer understands the risk of serious injury or death in the operation of such products and shall agree to take the **necessary precautions** and exercise **good judgment** to avoid hazards and dangerous situations which may result in serious injury or death.
2. The customer shall agree to indemnify and hold harmless MUKUTA from all injuries or death arising from the operation of the product.
3. The use of safety and protective gear such as bicycle helmets is strongly encouraged. And so is the use of Good Judgement.
4. The customer is advised to take the following precautions:
  - a. Do not ride on wet ground or in heavy rain;
  - b. Take corners slowly and look out for pedestrians;
  - c. Avoid potholes, curbs and debris on the ground;
  - d. Keep tires pumped to the specified pressure;
  - e. Dismount in places with heavy human traffic and push the scooter manually;
  - f. Service the product every 3 months on regular usage, 6 months for non-frequent usage;
  - g. Do not use product on public roads and respect local road regulations.

**How to request service under this Limited Warranty:**

To obtain performance of MUKUTA to repair and/or replace the Product or its Components under this Limited Warranty, the customer must, during the Warranty Period:

1. Bring this Limited Warranty, proof of purchase and the Product to MUKUTA.
2. Provide MUKUTA with a written description of the problem.

The average repair time is 1 to 3 days, not including shipping time to and from our service centre.

This warranty does not cover the shipping costs associated with the transportation of the scooter to and from our service centre, and a fee will be charged for return shipping or pick up and delivery service.

**What can the consumer do in case of a dispute with MUKUTA**

The consumer and MUKUTA agree that in the event of a dispute arising from the material and workmanship of the Product; or from this Limited Warranty, parties will attempt to first resolve the matter by negotiating in good faith.

## ERROR CODE

<b>Error Code</b>	<b>Fault</b>	<b>Diagnostic Step</b>	<b>Resolution</b>
00	Normal Status	Normally ok; Turn off and on the scooter to see if the error persists	Normally ok
02	Brake	Check brake lever on handlebar and see if brake springs back all the way	Give the brake lever a few hard presses to ensure that it is not stuck; If jammed, then unclog the source of the jam
		Check brake caliper to see if the brake line is springing back to original position	If brake caliper is not springing back, spray some WD40 to make sure it springs back to original position
06	Battery Undervoltage	Check LCD settings P03 and P15; Give battery a full charge to see if issue persists	P03 should be in accordance with the voltage specified in the user manual. P15 should be the specified voltage - 49V
07	Motor Fault	Unplug and plug motor connector back in to see if issue persists	If problem is resolved, then make sure connector is pushed in all the way.
		If issue persists; check motor wire and connector pins to see if there are any issues	Either replace the motor or replace motor wire.

# ERROR CODES

<b>Error Code</b>	<b>Fault</b>	<b>Diagnostic Step</b>	<b>Resolution</b>
08	Turnstile Fault	Check if back screw or magnet has come loose in the throttle/LCD	Tighten back screw or replace magnet in the throttle
09	Controller Fault	Replace controller	Replace controller
10	Communication Receiving Fault	Unplug and plug in LCD connector and see if issue persists; IF issue persists, then wiggle the LCD wire in different directions to see if problem persists	Change of wiring hardness from LCD to controller might be needed if the issue persists
11	Communication Transmission Fault	Unplug and plug in controller connector and see if issue persists; IF issue persists, then wiggle the LCD wire in different directions to see if problem persists	Change of wiring hardness from LCD to controller might be needed if the issue persists

# Included in the box

SERIAL NUMBER	ITEM	QUANTITY
1	Charger	1
2	Combination tool	1
3	NFC card	3

# Limited Warranty

BY USING THIS PRODUCT YOU AGREE TO THIS LIMITED WARRANTY. PLEASE READ THIS LIMITED WARRANTY CAREFULLY.

To benefit from the limited warranty, the customer is advised to read MUKUTA Warranty terms together with the “care and maintenance” sections provided in the user manual. This limited warranty applies to the extent permitted by law and unless restricted or prohibited by law.

## Limited Warranty Details

1. MUKUTA warrants that MUKUTA scooter products (“Products” or “Product”), are free from defects in material and workmanship, according to the following terms and conditions:
2. This Limited Warranty extends to the original purchaser of the Product warranted under this warranty and to each transferee of the Product during the first \_\_\_\_\_ months beginning on (date) \_\_\_\_\_ as stated below (“Warranty Period”).

This Limited Warranty covers the Product and each of its following component parts (“Components”) only:

- a. Hub motor;
  - b. Battery packs (except if battery was short-circuited or seals of the battery enclosure or cells were broken or were tempered or the battery was used in equipment other than its intended use);
  - c. Controller;
  - d. NFC Display;
  - e. Charger unit;
  - f. All other electrical wiring and components.
3. During the Warranty Period, MUKUTA or its authorized service centres will repair or replace, at MUKUTA’s option and without costs to the customer, any defective Components with new or factory rebuilt replacement items, and return the Products to the customer in working condition, provided that the terms and conditions of this Limited Warranty are met. All defective Products or Components that have been replaced shall become the properties of MUKUTA.
  4. Products and/or Components that have been repaired or replaced pursuant to the paragraph above will be covered by this Limited Warranty for the balance of the Warranty Period.
  5. This Limited Warranty will only be effective when presented together, to either MUKUTA or its authorised centres, with proof of date and place of purchase of Products such as the purchase receipt.

What this Limited Warranty does not cover:

1. Products used for commercial purpose(s) including but not limited to leasing/hiring, use in competitions, etc
2. Any logistical costs of returning the Product to MUKUTA or its authorised service centres for servicing or the cost of returning the Product to the customer after servicing.
3. Defects or damages resulting from use of the Product(s) other than its normal and customary manner as stated in the user manuals accompanying the Products.
4. Defects or damages from improper storage, exposure to moisture or dampness, modifications, connections, repairs (except as carried out by MUKUTA or its authorised centres), misuse, neglect, abuse, accident, alteration, improper installation, or other acts which are not the fault of MUKUTA, including damage caused by dropping, blown fuses, spills of food or liquid.
5. Defects or malfunctions of the product not notified by customer during the Warranty Period.
6. Products which have had their serial numbers removed or tampered with.
7. This Limited Warranty is in lieu of all other warranties, express or implied either in fact or by operations of law, statutory or otherwise, including, but not limited to any implied warranty of marketability or fitness for a particular use.

# After-sales service

For any problem listed in following table,our distributor will provide perfect after-sales service within the scope of warranty.

Part	Quality issue	Warranty period	Remarks
Motor	Seriously broken rubber wheel hub,faulty motor	14 months	Free repair
Accelerator	Unable to use with normal conditions (except damage caused by impact)	25 months	Free repair
Controller	Fault during normal use	14 months	Free repair
Charger	Fault during normal use	25 months	Free repair
Lithium battery	No output during normal use	14 months	Free repair
Framework	Deformation or fracture during normal use	25 months	Free repair

## Attentions for warranty

Faults caused by any of following causes are not within the scope of warranty:

1. Failed to maintain according to this user manual;
2. Damage caused by misuse, traffic accident or accidental collision;
3. Damage caused by riding on abnormal roads or accidental collision;
4. Please do not expose this product to the blazing sun or out doors for a long time, as that will speed up the aging process of the product and cause malfunction.
- 5.Quick aging and malfunction of the product caused by dangerous play with the electric scooter,such as acrobatic play;
6. Damage to the vehicle caused by natural disaster or irresistible force;
- 7.Aesthetic Damage Not Covered - Water Damage Not Covered

Note: Pleas refer to the our website for updated information about after-sales,replacement,payable and free warranty.



Start date of warramty extension	(DDMMYY)
Start date of warramty extension	(DDMMYY)
Start date of warramty extension	(DDMMYY)

### User information:

Name: \_\_\_\_\_

Contact number: \_\_\_\_\_

Email: \_\_\_\_\_

Address: \_\_\_\_\_

### Product information:

Mode: \_\_\_\_\_

Repair station: \_\_\_\_\_

Date of return: \_\_\_\_\_

Fault description: \_\_\_\_\_

Fault Cause: \_\_\_\_\_

Signature of the repairer: \_\_\_\_\_

NEW MODELS ARE COMING SOON

 Web: [www.mukutariding.com](http://www.mukutariding.com)

 Facebook: Mukuta

 Instagram: mukuta\_scooters

 YouTube: mukutariding

 E-mail: [Sales@mukutascooter.com](mailto:Sales@mukutascooter.com)  
[Sales@mukutariding.com](mailto:Sales@mukutariding.com)

**USER MANUAL**

NINGBO MUKUTA INTELLIGENT TECHNOLOGY CO., LTD

