



8400JF FOUNTAIN

OVERVIEW

- Complete package includes motor unit, control panel, float with screens, mooring lines, cable, five interchangeable nozzles.
- Cable is UL, CSA & NEC rated for underwater use.
- Total package Listed by ETL to UL/CSA standards.
- Intake near surface allows for shallow operation
- Saltwater compatible
- Packaged for convenient shipping
- Optional lighting available

FLOAT

- UV-resistant polyethylene
- Single-piece float
- Series 300 stainless steel hardware
- Series 300 stainless steel bottom screen
- Three 50' braided nylon mooring ropes

FOUNTAIN COMPONENTS

- Custom thermoplastic impeller
- UV-resistant thermoplastic cone and fountain housing
- Series 300 stainless steel hardware
- Five thermoplastic nozzles
- Twist on/off nozzles for easy pattern changes

POWER CABLE

- 3 wire (L1, L2, G)
- Quick Disconnect standard on 12+ AWG cords (otherwise optional)
- Stainless steel strain relief on 12+ AWG cords
- 6' flex sleeving protection standard (optional for entire cord length)

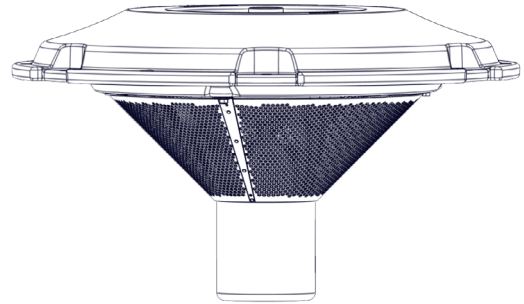

Dimensions

Float diameter: 37.5"

Unit height with float: 21.5"

MOTOR UNIT

- 2HP, 208-240Vac operating voltage range, single phase
- 1750 RPM
- Oil cooled
- Continuous duty rated
- 17mm top and 20mm bottom bearings
- Thermal overload protection
- Fully unitized heavy-duty carbon-ceramic mechanical seal
- Series 300 stainless steel can
- Engineering grade thermoplastic top
- Sacrificial anode installed on 316 stainless shaft

CONTROL PANEL

- UL 508 Listed
- UL type 3R/4X thermoplastic enclosure
- 20 amp breaker
- Human-rated GFCI protection
- Surge protector
- 24-hour mechanical fountain timer
- Terminal block wiring
- 24-hour mechanical timer for optional lighting
- 4-wire power required (L1, L2, N, G)

8400JF FOUNTAIN

OVERVIEW

HP	Voltage / Phase / Hz	Running Amps	Lock Rotor Amps	Suggested Pond Size (SA)	Min. Depth of Operation (in.)
2	208-240V / 1 / 60	10	40	Up to 1*	20"

*Surface Acreage; also consider pond shape, depth, and oxygen demand.

MODEL SPECIFICATIONS

Model	Cord Length (ft.)	Cord Gauge	Number of Boxes
8400JF050	50	14/3	3
8400JF100	100	12/3	4
8400JF150	150	12/3	4
8400JF200	200	12/3	4
8400JF250	250	12/3	4
8400JF300	300	10/3	4
8400JF400	400	8/3	4**
8400JF500	500*	8/3	4**

*500' and longer cords available by custom order only.

**Ships motor freight only.



INCLUDED PATTERNS

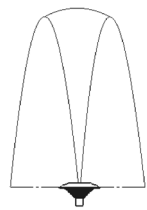

Birch
11' H x 10' W

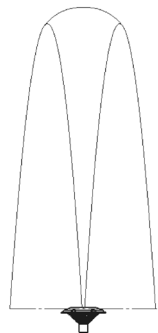

Spruce
21' H x 10' W

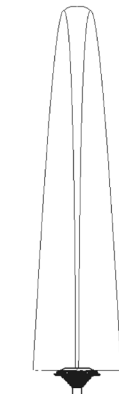

Redwood
22' H x 6' W

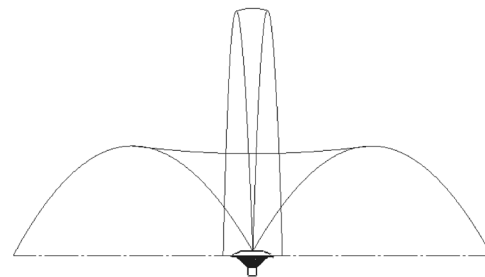

Linden
15.5' H x 38' W

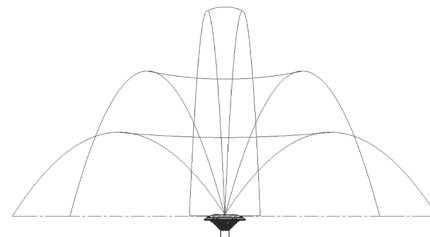

Balsam
14' H x 32' W

NOTE  For additional patterns, ask about Premium nozzles.

