



Innovator of Great Ideas

LTI TOOLS by MILTON™
4500 W. Cortland St., Chicago, IL 60639
Toll Free 1-800-421-7241
WEB: www.ltitools.com • E-mail: ltitools@ltitools.com

**LTI TOOLS by MILTON™ HAS AN AWARDS AND ROYALTY PROGRAM FOR YOUR
NEW HAND TOOL IDEAS. WE OFFER YOU INTERNATIONAL DISTRIBUTION.
IF YOU HAVE A NEW PRODUCT IDEA, PLEASE CONTACT US.**

WHEEL & BRAKE

LT830A Universal Hub Shocker

Safely remove all frozen hubs instantly without damaging the axle. Universal fit mounts to all axle bolted hubs - 5, 6 & 8 lug hubs. Mounts to two studs using the supplied flanged nuts in seconds. Use with 5 lb. hammer to knock frozen hubs out of axles. Flanged nuts included for improved safety and performance. Ideal for Dodge and other HD trucks. Two mounting holes in 3/4" steel back plate. 1/4" steel square tubing and striking plate.



Included flanged nut sizes - 2 each

- 12mm - 1.50
- 14mm - 1.50
- 7/16" - 20
- 1/2" - 20
- 9/16"
- 5/8" - 18



Scan to see tool work!



IN USE

LT993 Brake Re-threading Kit

The LT993 re-threads damaged brake wheel cylinders, master cylinder fittings, ABS control module fittings and brake line fittings on vehicles. Works on vehicle where stand alone tap and dies won't fit. Convenient, fast and easy vehicle applications. Compact design male/female combo sockets.

Includes most common SAE & Metric sizes

- 3/8 - 24
- 7/16 - 24
- 1/2 - 20
- 5/8 - 18
- 10mm - 1.0
- 12mm - 1.0



PTEN INNOVATION AWARDS 2016
BRAKE SERVICE

THE LT993 WORKS ON -

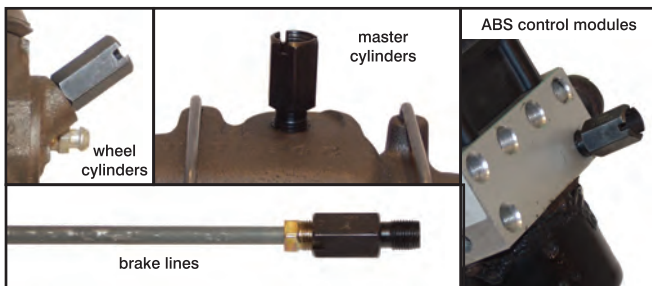

LT770 Universal Brake Piston Press

The LT770 Universal Brake Piston Press is for pressing in dual brake pistons and single brake pistons. Universal application for most cars, light and heavy trucks. Single piece operation - eliminates nuts and bolts to assemble and disassemble on brake assemblies.



IN USE - single piston

NEW & IMPROVED



IN USE - dual piston

LT4569 German Vehicle Rotating Ring Lug Nut Removal Kit

AUDI - BMW - PORSHCE - MERCEDES BENZ - VW

Easily removes rotating ring lug nut wheel locks. Use the heat resistant LT4569A Silicon Welding Shield to protect wheel from heat damage. Then a Mig welder is used to apply weld slag material at 4 front corners of lug nut. The extra weld material welded to face of lug nut will provide an ideal surface for the LT4569B Twist Socket to grab lug nut for easy removal. LT4569A consumable item with factory defect warranty only. LT4569B has a lifetime warranty for manufacturing defects only. Patent Pending on LT4569A Silicon Welding Shield.

TIRE & WHEEL SERVICE



LT4569A



LT4569B



Scan to see tool work!



LT1350 Lug Ripper II

Don't torch frozen/damaged lug nuts off - just drill out the lug nut threads and the wheel stud ONLY in 11 minutes or less. Easily replace damaged lug nut and wheel stud. Does not damage rim. **NEW & IMPROVED 16mm STEP UP COBALT DRILL BIT**. Comes with a locking collar clamp for safety. Includes 4 drill guides. Packaged in a custom blow molded carrying case. **LT1350-8 Water Bladder is NOW AVAILABLE AGAIN**. Conveniently portable coolant source. A must for keeping your Lug Ripper II cool. Hang it on the vehicle, no matter where you are, using the two included s-hooks. Keep coolant flowing when no water source is available. **ALLOWS FOR ONE PERSON OPERATION**. Includes 6' hose with water control valve. Patent #10,549,355 B1.

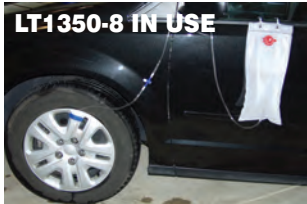

LT1350-8 WATER BLADDER

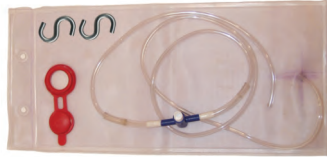

BACK BY POPULAR DEMAND!

Scan to see an instructional video for the new & improved LT1350-6 drill bit!



Drill guide sizes -
17mm - 11/16"
19mm - 3/4"
21mm - 13/16"
23mm - 7/8"



**NEW & IMPROVED LT1350-6
16mm STEP UP COBALT DRILL BIT**



**Drills out the lug nut threads
and the wheel stud only**

LT890 Truck Brake Spring Tool

The LT890 easily connects rear drum brake return springs. Easy one hand operation. Slotted ends on tool always hold spring at correct work angle. No need to leverage tool against a solid surface during spring installation. **FAST - EASY - SAFE**



Scan to see tool work!



**ADJUSTS
TO 3 SIZES**



BRAKE SERVICE

LT895 Eaton Truck Brake Spring Tool

The LT895 easily removes and installs Eaton air brake shoe anchor springs. Universal fit for all Eaton air brake shoe anchor springs. **FAST - EASY - SAFE**

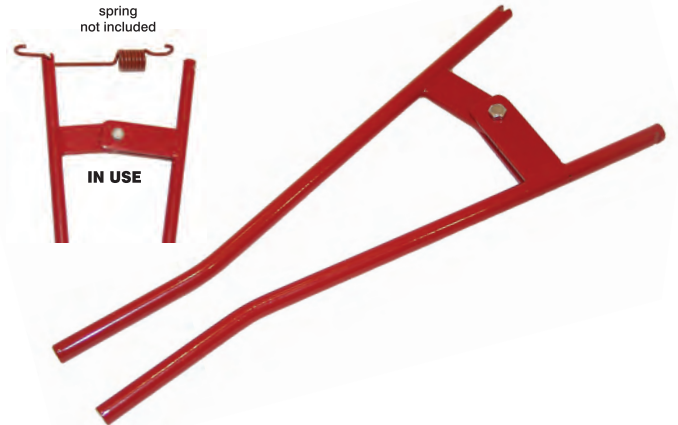

LT891 Bendix/Knorr-Bremse Air Disc Brake Pad Retainer Tool

The only tool made for servicing Bendix/Knorr-Bremse air disc brakes. No more using your hand to remove or install air disc brake pad retainers. Provides safer and easier way to remove pad retainer. Works with left and right side calipers. Heat treated for strength and durability. Designed to work with or without caliper shield. Easy grip handle. Patent pending.



Scan to see tool work!



**NEW
PRODUCT**



LT4150 VW/AUDI Wheel Lock Key Kit

The LT4150 is a 23 piece factory reproduced master wheel lug nut key/bolt kit for the removal of all 1st generation VW/Audi factory wheel lug nut locks. This kit includes 22 splined lug nut keys with a nylon sleeved 1/2" drive 17mm installer socket. Identical to factory set - uses same factory part numbers. Packaged in a custom blow molded carrying case.

WORKS ON 1ST GENERATION
VW/AUDI WHEEL LOCKS



INDIVIDUAL LT4150
WHEEL LOCK KEY



LT4155 VW 2nd Generation Wheel Lock Master Key Set

The LT4155 is a 20 piece factory reproduced master wheel lock key set for the removal of all 2nd generation 2009-present VW factory wheel lug nut locks. Identical to factory set - uses same factory part numbers. Packaged in a custom blow molded carrying case.

NO WARRANTY - CANNOT BE USED
WITH AN IMPACT GUN.

WORKS ON 2ND GENERATION
VW WHEEL LOCKS



INDIVIDUAL LT4155
WHEEL LOCK KEY



LT4160 BMW Wheel Lock Bolt Kit

The LT4160 is a 21 piece factory reproduced master wheel lug nut key/bolt kit for the removal of all 1st generation BMW internal spline drive wheel locks. This kit includes 20 splined lug nut keys with a nylon sleeved 1/2" drive 17mm installer socket. Identical to factory set - uses same factory part numbers. Packaged in a custom blow molded carrying case.

WORKS ON 1ST GENERATION
BMW WHEEL LOCKS



INDIVIDUAL LT4160
WHEEL LOCK KEY



LT4165 BMW 2nd Generation and Mercedes Benz "B" Wheel Lock Master Key Set

The LT4165 is a 20 piece factory reproduced master wheel lock key set for the removal of all 2nd generation 2011-present BMW factory wheel lug nut locks. Covers 20 of 60 Mercedes Benz master wheel lock keys. Identical to factory set - uses same factory part numbers. Packaged in a custom blow molded carrying case.

NO WARRANTY - CANNOT BE USED
WITH AN IMPACT GUN.

WORKS ON 2ND GENERATION
BMW WHEEL LOCKS



INDIVIDUAL LT4165
WHEEL LOCK KEY



LT4170 Porsche Wheel Master Lock Set

The LT4170 is a 20 piece factory duplicate master wheel lock key set for the removal of 2006-present Porsche factory wheel lug nut locks. Identical to factory set - uses same factory part numbers. Packaged in a custom blow molded carrying case.



INDIVIDUAL LT4170
WHEEL LOCK KEY



LT4175 Audi Wheel Master Lock Set

The LT4175 is a 20 piece factory duplicate master wheel lock key set for the removal of 2006-present Audi factory wheel lug nut locks. Identical to factory set - uses same factory part numbers. Packaged in a custom blow molded carrying case.

NO WARRANTY - CANNOT BE USED
WITH AN IMPACT GUN.



INDIVIDUAL LT4175
WHEEL LOCK KEY



LT4180 Mercedes Benz "A" Wheel Lock Master Key Set

The LT4180 is a 30 piece kit that works on 2006-present MERCEDES BENZ factory wheel lug nut locks. Factory duplicate - uses same factory part numbers. NOTE: Covers 30 of the 60 Mercedes factory master wheel lock keys. Packaged in a custom blow molded carrying case.



INDIVIDUAL LT4180 WHEEL LOCK KEY



NO WARRANTY - CANNOT BE USED WITH AN IMPACT GUN.

LT4181 Mercedes Benz "C" Wheel Lock Master Key Set

The LT4181 is a 10 piece factory duplicate master wheel lock key set for the removal of 10 of the 60 Mercedes Benz factory wheel lug nut locks. Identical to factory set - uses same factory part numbers. Packaged in a custom blow molded carrying case.



NO WARRANTY - CANNOT BE USED WITH AN IMPACT GUN.



INDIVIDUAL LT4181 WHEEL LOCK KEY

LT1230 5 Pc. 1/2" Drive Dual Sided Socket Lug Nut Removal Kit w/Punch

Use these dedicated sockets every time you remove damaged/distorted lug nuts with steel caps. These lug nuts become distorted due to improper leverage using the factory supplied tire iron. Removing over-torqued lug nuts during extreme cold/heat also distorts lug nut cap. Dual flip 1/2" drive impact socket design. Comes in a custom vinyl case. Includes 4 lug nut removal tools and an Extractor Punch.



Works on damaged/distorted lug nuts with steel caps



- | | |
|----------|----------------------------------|
| LT1240 | 21/21.5mm Chrome Cap Buster |
| LT1250 | 18.5/19.5mm Chrome Cap Buster |
| LT1260 | 22/22.5mm Chrome Cap Buster |
| LT1270 | 1 1/16"/27.5mm Chrome Cap Buster |
| LT-400-7 | Extractor Punch |

LT1233 4 Pc. 1/2" Drive Dual Sided Socket Lug Nut Removal Kit w/Punch

Use these dedicated sockets every time you remove damaged/distorted lug nuts with steel caps. These lug nuts become distorted due to improper leverage using the factory supplied tire iron. Removing over-torqued lug nuts during extreme cold/heat also distorts lug nut cap. Dual flip 1/2" drive impact socket design. Comes in a blow molded carrying case. Includes 3 lug nut removal tools and an Extractor Punch.



Works on damaged/distorted lug nuts with steel caps



- | | |
|----------|-------------------------------|
| LT1240 | 21/21.5mm Chrome Cap Buster |
| LT1250 | 18.5/19.5mm Chrome Cap Buster |
| LT1260 | 22/22.5mm Chrome Cap Buster |
| LT-400-7 | Extractor Punch |

LT1240 1/2" Drive Dual Sided Socket Lug Nut Remover Tool 21/21.5mm Chrome Cap Buster

Dual flip 1/2" drive impact design. Removes missing and distorted lug nuts with chrome caps. Works on Chrysler/Dodge 21mm chrome cap lug nuts. Use this dedicated socket every time you remove 21mm lug nuts.

LT1260 1/2" Drive Dual Sided Socket Lug Nut Remover Tool 22/22.5mm Chrome Cap Buster

Dual flip 1/2" drive impact design. Removes missing and distorted lug nuts with chrome caps. Works on all Chrysler/Dodge 22mm chrome cap lug nuts. Use this dedicated socket every time you remove 22mm lug nuts.

LT1250 1/2" Drive Dual Sided Socket Lug Nut Remover Tool 18.5/19.5mm Chrome Cap Buster

Dual flip 1/2" drive impact design. Removes missing and distorted lug nuts with chrome caps. Works on 19mm chrome caps found on many GM & Chrysler vehicles. Use this dedicated socket every time you remove 19mm lug nuts.

LT1270 1/2" Drive Dual Sided Socket Lug Nut Remover Tool 1 1/16"/27.5mm Chrome Cap Buster

Dual flip 1/2" drive impact design. Removes missing and distorted lug nuts with chrome caps. Works on Range Rover/Land Rover chrome cap lug nuts. Use this dedicated socket every time you remove 1 1/16" lug nuts.

LT2510

E-Z Loader Magazine Lug Nut Socket

The E-Z Loader is a magazine loading impact socket for multiple lug nut removal. The E-Z Loader removes up to 5 lug nuts at the wheel work site and allows the mechanic to release all of the lug nuts at once. No more rolling or lost lug nuts and wasted motion. The E-Z Loader also adjusts type 9, 12, and 16 cubic inch air chambers that are equipped with 1/2" 20 threaded rod and 3/4" nut. A "MUST" tool for tire shops, brake shops, and locations with high volume wheel removal.

LT2510 3/4", 19mm

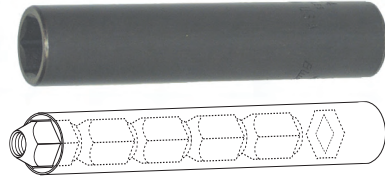

LT4996 17 Pc. Foreign and Domestic Brake Caliper Socket And Bit Kit

Increase applications for most domestic as well as foreign vehicle brake calipers. Most car brake caliper bits/sockets when you need them. Packaged in a custom blow molded case. LT4996 upgrades and replaces the LT4995. Individual parts for LT4995 are available as needed.

INCLUDES:

1/4" drive bit -	1/2" drive sockets -
9mm x 20mm	11.5mm x 50mm
3/8" drive bits -	AS22 x 48mm
7mm x 24mm	10PT x 15mm
8mm x 24mm	10PT x 20mm
9mm x 50mm	7pt
7mm x 65mm	PENT x 10mm
7mm x 92mm	PENT x 12.5mm
11mm x 100mm	PENT x 14mm
1/2" drive bit -	PENT x 19mm
10mm	

**NEW
PRODUCT**



LT4875, LT4875A, LT4876 & LT4876A Lug Nut Removal Flip Sockets

These Lug Nut Removal Flip Sockets are for the easy removal of lug nuts. The thin wall flip sockets allow for removal of lug nuts on specialty wheels and tight tolerances. Individually packaged.

Individual Lug Nut Flip Sockets:

LT4875	3/4", 19mm; 13/16"
LT4875A	3/4", 19mm; 13/16", THIN WALLED
LT4876	19mm; 21mm
LT4876A	19mm; 21mm, THIN WALLED



LT465 12MM & 14MM Wheel Hanger Guides

Wheel Hanger Guides slide into wheel lug nut holes without using threads aiding technicians during wheel mounting. Saves time - no threads, no turning wheel guides to install and remove. Works on Mercedes, Audi, BMW, Mini Cooper, SAAB and Volvo vehicles. Wheel Hanger Guides support wheel/tire so technician can easily thread lug nut bolts into brake rotor. Each kit includes one 12MM and one 14MM Wheel Hanger Guide. Easily slides in and out of rotor holes without using threads. Must have for removing wheels. Helps prevent scratches on expensive wheels. Made of durable bulletproof polycarbonate plastic. Purchase a LT465 kit for the price of one steel hanger pin.



LT-4000 Deluxe Hubcap & Wheel Lock Removal Kit

The LT-4000 safely removes and replaces GM, Ford, and Chrysler wire wheel hubcap locks on 1978-1997 vehicles. This kit also removes factory and most after market mag wheel locking nut locks. Includes the LT4200A Dual Sided Twist Socket Lug Nut Remover. Includes instructions and is packaged in a custom blow molded carrying case.



LT-760 Brake Shoe Adjuster Pin Installer

The LT-760 quickly and safely presses all 3 sizes of brake shoe adjuster lever posts into the brake shoes (using an air hammer). The narrow tapered end of the tool will easily clear the bent over webbing found on most brake shoes. A real time saver.



TORQUE SOCKETS

Wheel Torque Master Sockets will torque wheel nuts to the correct torque the first time, every time, on most makes and models of Foreign & Domestic cars, light trucks, SUV's and vans. Torque Master Sockets are easy to use and are color coded for quick identification. Using a torque socket avoids over-torquing wheel nuts and prevents Major wheel and Brake damage. These tools are designed for use with a 1/2" drive impact wrench.



Torque Master Sockets used with your 1/2" drive impact wrench

BROWN	LT1500A	13/16" - 100 Ft/Lbs., 135 N.M.
LEMON GREEN	LT1500AA	22mm - 80 Ft/Lbs., 110 N.M.
ORANGE	LT1500B	21mm - 80 Ft/Lbs., 110 N.M.
TURQUOISE	LT1500BB	21mm - 150 Ft/Lbs., 200 N.M.
GRAY	LT1500C	3/4"/19mm - 100 Ft/Lbs., 135 N.M.
PINK	LT1500CC	17mm - 90 Ft/Lbs., 120 N.M.
BLACK	LT1500D	21mm - 60 Ft/Lbs., 80 N.M.
SKY BLUE	LT1500DD	21mm - 100 Ft/Lbs., 135 N.M.
BLUE	LT1500E	3/4"/19mm - 80 Ft/Lbs., 110 N.M.
SAFETY PURPLE	LT1500EE	22mm - 140 Ft/Lbs., 190 N.M.
YELLOW	LT1500F	3/4"/19mm - 65 Ft/Lbs., 90 N.M.
RED	LT1500G	17mm - 80 Ft/Lbs., 110 N.M.
BEIGE	LT1500GG	1 1/16" - 80 Ft/Lbs., 110 N.M.
LIGHT ORANGE	LT1500HH	1 1/16" - 100 Ft/Lbs., 135 N.M.
WHITE	LT1500I	7/8" - 120 Ft/Lbs., 160 N.M.
TAN	LT1500J	1" - 140 Ft/Lbs., 190 N.M.
PURPLE	LT1500K	17mm - 110 Ft/Lbs., 150 N.M.
APPLE GREEN	LT1500L	1" - 170 Ft/Lbs., 230 N.M.
BUBBLE GUM	LT1500LL	22mm - 175 Ft/Lbs., 235 N.M.
GOLD	LT1500NN	3/4"/19mm - 90 Ft/Lbs., 120 N.M.
AQUA	LT1500Q	7/8" - 140 Ft/Lbs., 190 N.M.
SALMON	LT1500QQ	22mm - 95 Ft/Lbs., 130 N.M.
LIGHT BLUE	LT1500S	3/4"/19mm - 55 Ft/Lbs., 75 N.M.
SILVER	LT1500SS	21mm - 110 Ft/Lbs., 150 N.M.
LIME GREEN	LT1500TT	15/16" - 135 Ft/Lbs., 175 N.M.
COPPER	LT1500VV	22mm - 110 Ft/Lbs., 150 N.M.
VANILLA	LT1500XX	13/16" - 160 Ft/Lbs., 220 N.M.
NAVY BLUE	LT1500Y	7/8" - 100 Ft/Lbs., 135 N.M.



LT-1500-LWC Wheel Torque Socket Laminated Wall Chart ©April, 2022

The 28.25" x 34.25" Laminated Wheel Torque Chart is a must for any high volume tire or brake shop using Torque Master sockets. Easily allows many mechanics to quickly verify wheel torque values from a distance. Fully updated every year and includes 31 color coded Torque Master Socket specs and the thousands of vehicles that they work on.

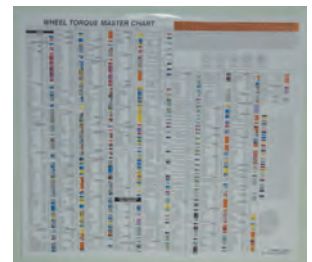

LT-1500WC Wheel Torque Socket Color Wall Chart ©April, 2022

The 13" x 15.75" Wheel Torque Socket Color Chart is a must for any high volume tire or brake shop using Wheel Torque Master Sockets. Small size of chart allows you to store chart in a tool box or at a service bay. Fully updated every year and includes 31 color coded Wheel Torque Master Socket specs and the thousands of vehicles that they work on.

LT-1400WC Wheel Torque Extension Color Wall Chart ©April, 2022

The 13" x 14.82" Wheel Torque Extension Color Chart is a must for any high volume tire or brake shop using Wheel Torque Extensions. Small size of chart allows you to store chart in a tool box or at a service bay. Fully updated every year and includes 7 color coded Wheel Torque Extension specs and the thousands of vehicles that they work on.

LT1500 8 Piece Wheel Torque Master Kit

The LT1500 is an 8 piece Wheel Torque Master Kit. These tools are designed for use with a ½" drive impact wrench and come in a custom molded case with a yearly updated color wall chart (LT-1500WC). (Includes sockets A, B, C, E, F, G, I & Q)



LT1510 10 Piece Wheel Torque Master Kit

The LT1510 is a 10 piece Wheel Torque Master Kit. These tools are designed for use with a ½" drive impact wrench and come in a custom molded case with a yearly updated color wall chart (LT-1500WC). (Includes sockets A, B, BB, C, E, F, G, I, K & Q)



LT1550 4 Piece Domestic Wheel Torque Master Kit

The LT1550 is a 4 piece Domestic Wheel Torque Master Kit. These tools are designed for use with a ½" drive impact wrench and come in a custom molded case with a yearly updated color wall chart (LT-1500WC). (Includes sockets A, C, E, & I)



LT1560 4 Piece Light Truck & SUV Wheel Torque Master Kit

The LT1560 is a 4 piece SUV, Light Truck & Van Wheel Torque Master Kit. Sockets are deep well forged to accommodate light trucks, SUV's and vans. These tools are designed for use with a ½" impact wrench and come in a custom molded case with a yearly updated color wall chart (LT-1500WC). (Includes sockets BB, I, Y & Q)



LT1590 & LT1593 9 Piece Wheel Torque Master Kits

The LT1590 & LT1593 are 9 piece Wheel Torque Master Kits. These tools are designed for use with a ½" drive impact wrench. These kits come with a yearly updated color wall chart (LT-1500WC) and are available with a custom rack (LT1590) or with a custom case (LT1593). (Includes sockets A, B, BB, C, E, F, G, I & Q)



LT1595 12 Piece Wheel Torque Master Kit

The LT1595 is a 12 piece Wheel Torque Master Kit. This is our most complete kit available today. These tools are designed for use with a ½" drive impact wrench and come in a wall mountable carrying case with a yearly updated color wall chart (LT-1500WC). (Includes sockets A, B, BB, C, DD, E, F, G, I, K, Q & TT)









TORQUE EXTENSIONS

The 1/2" Drive Wheel Torque Extensions will torque wheel nuts on most foreign and domestic cars and light trucks to the correct torque, the first time, every time, with your thin wall or regular lug nut sockets. Since more vehicles every year have tight tolerances around the wheel nuts, this kit will help eliminate damage to wheels when torquing the wheel nuts.



Torque Extensions used with your 1/2" drive impact wrench and lug nut sockets



NEW		ORANGE	LT1400BB - 160 Ft/Lbs., 215 N.M.
		GRAY	LT1400C - 100 Ft/Lbs., 135 N.M.
		BLUE	LT1400E - 80 Ft/Lbs., 110 N.M.
		YELLOW	LT1400F - 65 Ft/Lbs., 90 N.M.
		WHITE	LT1400I - 120 Ft/Lbs., 160 N.M.
		PURPLE	LT1400K - 110 Ft/Lbs., 150 N.M.
		AQUA	LT1400Q - 140 Ft/Lbs., 190 N.M.

LT1450 1/2" Drive 4 Piece Wheel Torque Extension Kit

The 4 piece extension kit does the work of 9 regular torque sockets. The 4 piece kit includes extensions C, E, F & I and comes in a custom molded carrying case with a yearly updated color wall chart (LT-1400WC).



LT1460 1/2" Drive Wheel Torque Extension Kits

The 5 piece extension kit does the work of 13 regular torque sockets. The 5 piece kit includes extensions C, E, F, I & Q and comes in a custom molded carrying case with a yearly updated color wall chart (LT-1400WC).



LT1470 1/2" Drive 7 Piece Wheel Torque Extension Kit

The 7 piece extension kit does the work of 16 regular torque sockets. The 7 piece kit includes extensions BB, C, E, F, I, K & Q and comes in a custom molded carrying case with a yearly updated color wall chart (LT-1400WC).



LT1600B, M, N, O, P, R, S, T, U, W & Y Heavy Duty 3/4" & 1" Drive Wheel Truck Extensions

These heavy duty truck extensions are designed to work with a 3/4" or 1" drive impact gun and your lug nut sockets on large truck wheel nuts.

3/4" Drive Truck Extensions:

LT1600O - 175 Ft/Lbs., LT1600N - 250 Ft/Lbs.,
LT1600U - 350 Ft/Lbs., LT1600M - 475 Ft/Lbs.,

1" Drive Truck Extensions:

LT1600T - 175 Ft/Lbs., LT1600R - 250 Ft/Lbs.,
LT1600S - 350 Ft/Lbs., LT1600B - 400 Ft/Lbs.,
LT1600P - 475 Ft/Lbs., LT1600Y - 550 Ft/Lbs.,
LT1600W - 650 Ft/Lbs.



TWIST SOCKETS

Twist Sockets have a fluted design which give the sockets a tight grip to remove the most difficult fasteners. Simply place the twist socket on and twist the damaged fastener off - it's that easy. No more pounding, chisels or torches. Safe and fast removal of damaged fasteners and easy removal of the fastener from the twist socket. Available in 3/8" and 1/2" drive sizes.

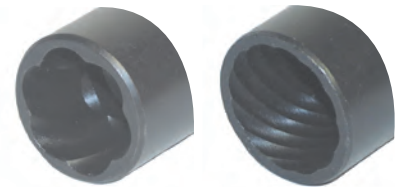

6 flute

12 flute

LT 4500, LT 4501 3/8" Drive 9 Piece Twist Socket Fastener Removal Systems

This kit easily removes damaged nuts, studs, pipe nipples and bolts. Available mounted on a 3/8" rail (LT 4500) or a custom blow molded case (LT 4501).



LT 4510	10mm	LT 4513	13mm	LT 4516	16mm, 5/8"
LT 4511	11mm, 7/16"	LT 4514	14mm	LT 4517	17mm
LT 4512	12mm	LT 4515	15mm	LT 4519	19mm, 3/4"



LT 4600 3/8" Drive 13 Piece Twist Socket Fastener Removal System

This kit easily removes damaged nuts, studs, pipe nipples and bolts. Comes mounted on a 3/8" rail, individually packaged.



LT 4510	10mm	LT 4515	15mm	LT 4620	3/8"
LT 4511	11mm, 7/16"	LT 4516	16mm, 5/8"	LT 4621	1/2"
LT 4512	12mm	LT 4517	17mm	LT 4622	9/16"
LT 4513	13mm	LT 4519	19mm, 3/4"	LT 4623	11/16"
LT 4514	14mm				

LT 4700 3/8" Drive DEEP WELL 13 Piece Twist Socket Damaged Fastener Removal System

This kit easily removes damaged nuts, studs, pipe nipples and bolts. Ideal for times when a deep well socket is needed. Comes mounted on a 3/8" rail, individually packaged.



LT 4510-D	10mm	LT 4515-D	15mm	LT 4620-D	3/8"
LT 4511-D	11mm, 7/16"	LT 4516-D	16mm, 5/8"	LT 4621-D	1/2"
LT 4512-D	12mm	LT 4517-D	17mm	LT 4622-D	9/16"
LT 4513-D	13mm	LT 4519-D	19mm, 3/4"	LT 4623-D	11/16"
LT 4514-D	14mm				

LT 4800 3/8" Drive 7 Piece Twist Socket Oil Drain Plug Removal System

This system easily removes the most commonly used damaged oil drain plugs. Comes mounted on a 3/8" rail, individually packaged.

LT 4513	13mm
LT 4515	15mm
LT 4516	16mm, 5/8"
LT 4517	17mm
LT 4519	19mm, 3/4"
LT 4622	9/16"
LT 4822	22mm



LT 4850 3/8" Drive 3 Piece Twist Socket Transmission Drain Plug Removal System

This system easily removes the most commonly used damaged transmission pan bolts. Comes mounted on a 3/8" rail, individually packaged.

LT 4510	10mm
LT 4621	1/2"
LT 4851	8mm



LT 4400 1/2" Drive 6 Piece Twist Socket Removal Kit

This kit easily removes damaged nuts, studs, pipe nipples and bolts. Comes mounted on a 1/2" rail, individually packaged.

LT 4400-30	19mm, 3/4"
LT 4400-35	13/16"
LT 4400-40	7/8"
LT 4400-45	15/16"
LT 4400-50	1"
LT-400-7	Extractor Punch



LT 4240 1/2" Drive 5 Pc. Locking Lug Nut Twist Socket Removal Kit

Removes locked or damaged lug nuts without a key. Now 4 sizes for maximum coverage. Lug nuts are usually reusable. Works with a breaker bar or other related tool. Comes mounted on a 1/2" rail, individually packaged.



LT 4400-30	19mm, 3/4"
LT 4400-35	13/16"
LT 4400-50	1"
LT 4400-70	1 3/16"
LT-400-7	Extractor Punch

LT 4300 3 Piece Twist Socket Lug Nut Removal System

The LT 4300 3 piece Twist Socket Lug Nut Removal System is for the removal of DAMAGED/ROUNDED 3/4"/19mm, 13/16" and 21mm lug nuts (LT4200A) and the majority of OEM and after market LOCKING LUG NUTS (LT400-25). These sockets are dual sided. Works with a breaker bar or other related tool. Includes an extractor punch (LT-400-7).

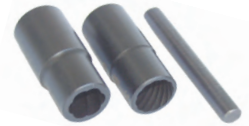

LT 4350 4 Piece Twist Socket Lug Nut Removal System

Removes DAMAGED/ROUNDED 3/4"/19mm, 13/16" and 21mm lug nuts (LT4200A). Removes the majority of OEM and aftermarket LOCKING LUG NUTS (LT400-25). Removes DAMAGED/ROUNDED 17mm lug nuts and OEM and aftermarket LOCKING LUG NUTS (LT400-17). These sockets are DUAL SIDED. Works with a breaker bar or other related tool. Includes an extractor punch (LT-400-7).



LT4200A Dual Sided Twist Socket Lug Nut Remover

The Dual Sided Twist Socket Lug Nut Remover is for the removal of damaged/rounded 3/4"/19mm, 13/16" and 21mm lug nuts because of unsuccessful removal, rust or other damage. Works with a breaker bar or other related tool.



LT400-17 Dual Sided Twist Socket Lug Nut Remover

The Dual Sided Twist Socket Remover is for the removal of DAMAGED/ROUNDED 17mm lug nuts and OEM and after market LOCKING LUG NUTS. Works with a breaker bar or other related tool.



LT400-25 Dual Sided Twist Socket Locking Lug Nut Remover

The Dual Sided Twist Socket Lug Nut Remover is for the removal of 3/4"/19mm, 13/16" and 21mm OEM and after market locking lug nuts. Works with a breaker bar or other related tool.



LOCK OUT KITS

LT-1000 Supreme Master Automotive Lock Out Kit

The Supreme Master Auto Lock Out Tool Kit contains 18 pieces and is the ultimate product available today to handle emergency lock outs. This kit is packaged in a custom heavy duty blow molded carrying case with vinyl inserts, and includes a fully illustrated instruction manual. The LT-1000 includes model no.'s: 40, 80A, 95, 99, 100, 101, 105, 106, 108, 110, 112, 113, 114, 116, 120 (118-1 & 120-2), 2-271's, 275.

INCLUDES THE LT275 INFLATE-A-WEDGE

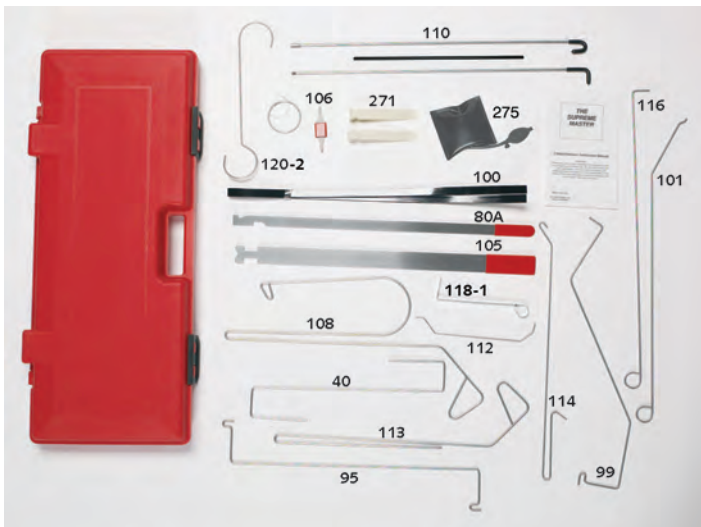

LT-500 Grand Master Automotive Lock Out Kit

The Grand Master is a comprehensive 14 piece automotive lock out tool kit. It has been updated to include new specialty tools. This kit includes a fully illustrated instruction manual and comes in a heavy duty vinyl carrying case. The LT-500 includes model no.'s: 40, 80A, 95, 100, 101, 105, 106, 108, 112, 114, 118-1, 118-2, 2-271's.



LT-450 Deluxe Master Automotive Lock Out Kit

The Deluxe Master includes the Lock Tech Tool (LT-108) and is a great value. Eliminates automotive lock out problems in emergency situations. This 11 piece tool kit unlocks most domestic and foreign cars and trucks on the road today. This kit includes a fully illustrated instruction manual and comes in a heavy duty vinyl carrying case. The LT-450 includes model no.'s: 40, 80A, 95, 100, 101, 105, 106, 108, 114, 2-271's.



LT-200 Mini Master Automotive Lock Out Kit

The Mini Master is the most comprehensive low cost kit available. Eliminates automotive lock out problems in emergency situations. This 9 piece tool kit unlocks most domestic and foreign cars and trucks on the road today. This kit includes a fully illustrated instruction manual and comes in a heavy duty vinyl carrying case. The LT-200 includes model no.'s: 40, 80A, 95, 100, 101, 105, 106, 114, 271.



LT-128 2 Pc. Skinny Rod Lock Out Kit

NEW PRODUCT

Designed and developed by a professional auto repossessor. Auto repossessors do not have the time to use air wedges, double sided tape, or pull wires to open car doors. Lift buttons have always been a problem to unlock using conventional door unlocking tools. U-shaped patent pending serrated knife-like work edges effortlessly grab and lift the slickest of lift buttons or can be maneuvered to activate power door locks. For quick easy entrance of tools, the LT-128A rod is 44" long x .187" thin. The LT-128B is 34" long x .125" super thin. To achieve maximum strength and rigidity the angled bend inflection points are stamped flat. Rods are zinc plated. Included in the kit is the LT276 Super Wedge. Its knife sharp edge and ribbed wash board surface ensure it is easy to insert and won't slide out of door during use. Also can be used to hold window in door channels during window regulator work and removes body moldings with sharp edge. Three tools in one wedge.

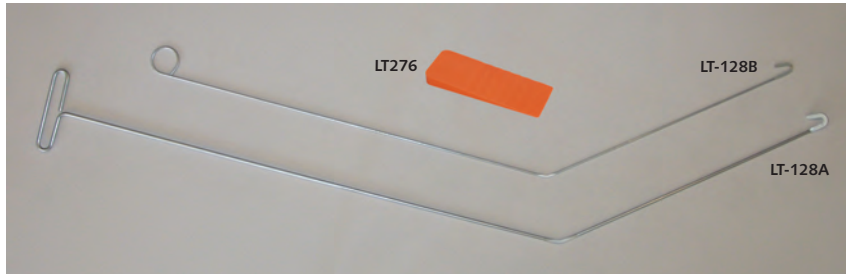

Scan to see tool work!

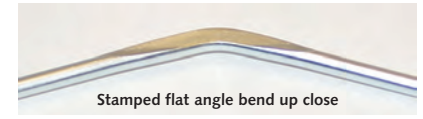

Stamped flat angle bend up close



LT-128A serrated U-shaped offset tip up close



LT-128B serrated U-shaped tip up close

LT-125 Easy Access Door Unlocking Kit

The LT-125 is dual sided - two tools in one - 54" long. **Whale tail tip** design places more working tip on lock surfaces. Grabs and catches lock more easily. Use with or without vinyl tips. Rods are zinc plated. Easy Access Door Unlocking Tool, two Plastic Door Wedges (LT271), and Plastic Slip Jim (LT-100). Comes packaged in a custom kraft cardboard box.



NEW & IMPROVED

WHALE TAIL TIPS UP-CLOSE

LT-130 Easy Access Door Unlocking System

The LT-130 is dual sided - two tools in one - 54" long. **Whale tail tip** design places more working tip on lock surfaces. Grabs and catches lock more easily. Use with or without vinyl tips. Rods are zinc plated. Easy Access Door Unlocking Tool, two Plastic Door Wedges (LT271), Inflate-A-Wedge (LT275) and Plastic Slip Jim (LT-100). Comes packaged in a custom kraft cardboard box.



WHALE TAIL TIPS

NEW & IMPROVED

LT135 2 Piece Easy Access Kit

The LT135 is a 2 piece Easy Access Tool that collapses for easy storage. It is 53" long with a rigid design for easy through the window reach. The LT135-3B now has **whale tail tip** design for more working tip on lock surfaces. Use with or without vinyl tips. Rods are green in color. Comes in a heavy duty vinyl bag. Also includes Plastic Slip Jim (LT-100) and two Plastic Door Wedges (LT271).

LT140 2 Piece Easy Access & Inflate-A-Wedge Kit

The LT140 is a 2 piece Easy Access Tool that collapses for easy storage. It is 53" long with a rigid design for easy through the window reach. The LT135-3B now has **whale tail tip** design for more working tip on lock surfaces. Use with or without the vinyl tips. Rods are green in color. Comes in a heavy duty vinyl bag. This kit also includes Plastic Slip Jim (LT-100), two Plastic Door Wedges (LT271) and Inflate-A-Wedge (LT275).



WHALE TAIL TIPS

NEW & IMPROVED

135-3A

135-3B



WHALE TAIL TIPS

NEW & IMPROVED

135-3A

135-3B

LT145 Super Multi-Purpose Easy Access & Inflate-A-Wedge Kit

The LT145 is a 4 piece Easy Access Tool that collapses for easy storage. This tool screws together **WITHOUT A COUPLER** for easier access. The LT135-3B now has **whale tail tip** design for more working tip on lock surfaces. Use with or without vinyl tips. Rods are green in color. Includes a middle extension piece (135-3D-1) to go across the car for long reach applications. Also includes a shorter tip (135-3C) for easier use with lock buttons. Rigid design for easy through-the-window reach. This kit also includes Plastic Slip Jim (LT-100), two Plastic Door Wedges (LT271) and Inflate-A-Wedge (LT275).

NEW & IMPROVED

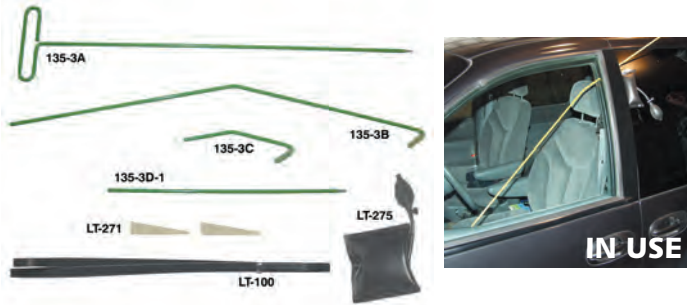

LT-148 Multi Piece Lock Out Kit

The LT-148 is a three piece easy storage lock out kit. Super strong 1/4" connector sleeve for long lasting durability. The LT-148-1B and LT-148-1C have whale tail tip design. Use with or without vinyl tips. The LT-148-1A handle works on lift buttons. Rods are zinc plated. This kit also includes Plastic Slip Jim (LT-100), two plastic door wedges (LT271) and Inflate-A-Wedge (LT275). Lifetime warranty. Rods made in USA.

NEW PRODUCT

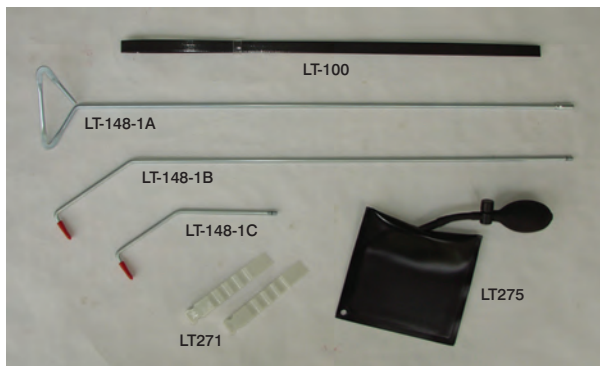

LT146 Quick Connect Lock Out Kit

The LT146 has a **super strong snap and lock design** that will not come apart during use. Fast quick connections in tough lockout situations. The LT146-QB & 146-QC now have **whale tail tip** design for more working tip on lock surfaces. Adjustable 5 piece kit for 33" reach to an amazing 53" reach. Rods are zinc plated. This kit also includes the Inflate-A-Wedge (LT275), Plastic Slip Jim (LT-100) and two Plastic Door Wedges (LT271). Also available is a 15" add-on extension - LT146-QD.

WHALE TAIL TIPS

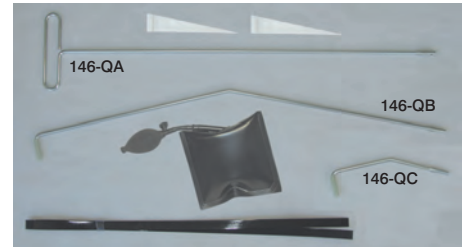

NEW & IMPROVED



LT271 Plastic Door Wedge

Dual use. Safely separates the door panel from the vehicle window. Holds door window during window regulator work.

LT275 Inflate-A-Wedge

The unique Inflate-A-Wedge allows you to safely separate the door frame from the vehicle body to insert a tool and unlock a vehicle.



LT276 Self Locking Door Wedge

The washboard design surface of wedge self locks in door. Its knife sharp edge and ribbed wash board surface ensure it is easy to insert and won't slide out of door during use. Great when inserting inflatable air wedges. Extra wide for extra leverage. Use it with or without an air wedge. Great for window regulator installation. Holds glass steady against window rubber stripping. Also removes body moldings with sharp edge. Three tools in one wedge.



LOCK OUT PICKS

LT-290 European & Asian Rocker Lock Pick Set

A six piece set of rocker picks designed for European and Japanese vehicles. Not for use on transponder based anti-theft ignition systems.



LT-310 Chrysler Automotive Rocker Lock Pick Set

A six piece pick set will open door & trunk locks and start Chrysler vehicles from 1969-1999, including tilt columns. Not for use with the Smart Key anti-theft ignition systems.



LT-300 Ford Automotive Rocker Lock Pick Set

A five piece pick set opens door and trunk locks of Ford, Lincoln and Mercury cars, vans & trucks for model years 1969-1999. To start ignitions with 10-cut locks (1984 1/2 - 1996) use the LT-78. Not for use on transponder based passive anti-theft systems.



LT-320 European & Asian Automotive Lock Pick Set

A six piece set designed for foreign wafer locks found in most Japanese and European vehicles. Includes Harpoon pick to remove broken keys from auto locks. Not for use on transponder based anti-theft ignition systems.



LT-620 Grand Master Lock Pick Set

The ultimate pick set containing 35 picks, including the LT-280, LT-290, LT-300, LT-310, LT-320, as well as the LT-330 tension wrench and LT-106 gas cap pick tool packaged in a custom leatherette case.



LT-340A AutoMaster Super Lock Pick Set

A complete master pick set containing 23 picks, including the LT-290, LT-300, LT-310, LT-320, as well as the LT-330 tension wrench and LT-106 gas cap pick tool packaged in a custom leatherette case.



LT-340 Master Lock Pick Set

A complete pick set containing 17 picks, including the LT-300, LT-310, LT-320, as well as the LT-330 tension wrench and LT-106 gas cap pick tool packaged in a custom leatherette case.



LT-280 GM Rocker Lock Pick Set

The GM Rocker Lock Pick Set consists of twelve double ended, single sided rocker picks. This creates 24 combinations covering the one-thousand plus possible key cut configurations for GM side bar locks. The LT-280 will work on many GM steering column, trunk and door locks. Not for use with 10-cut ignitions or ignition systems equipped with PassKey.



AIR HAMMERS & AIR HAMMER ACCESSORIES

LT855A Texas Twister™ Air Hammer Pulling Kit

Now you can convert your air hammer into a pneumatic slide hammer with the Texas Twister™. Simply snap the Texas Twister™ curved air bit into the collet of your hammer with one of the bits attached. Reverse the air hammer handle in your hand now using thumb to push the hammer trigger. Feel the 3000 air hammer blows per minute turning into new pulling power. One hand operation allows you to hold parts with your other hand. Safe controlled part removal without parts and fluids crashing to the floor. Use 21st century air hammer pulling power to get the job done SAFE, FAST & EFFICIENT instead of a slow, manually powered 19th century slide hammer. Extend the reach of the tool by using the 20" extension. Includes two puller connectors - 1/2"-20 to 5/8" and 1/2"-20 to 3/4" to connect the Texas Twister™ to your 5/8" & 3/4" slide hammer bits and pullers. Includes the LT855A-18 Vise Grip Adaptor to connect your 7/16-14 thread vise grips to the Texas Twister™. **NOW COMES PACKAGED IN A CUSTOM PLASTIC GRAY DISPLAY TRAY.** Includes a custom black ballistic nylon carrying case. Patent #7,036,211.

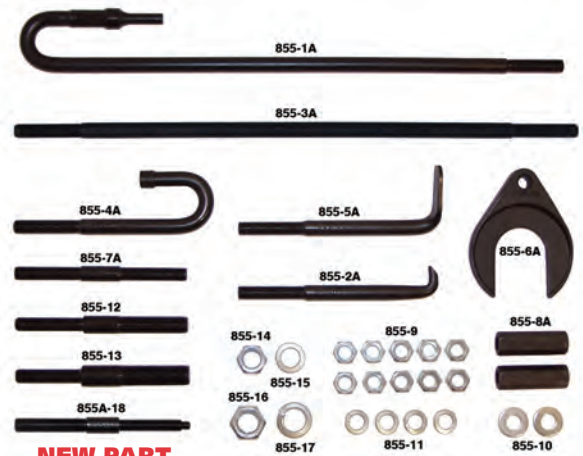

NEW PART ADDED



Scan to see tool work!

NEW GRAY DISPLAY TRAY

AIR HAMMER POWERED



TOOL ACCESSORIES

LT498 Big Nasty Texas Twister™ Air Hammer Pulling Kit

Use with any "Big Nasty" .498 locking chuck air hammer. The LT498 has maximum power for fleet, heavy equipment and industrial uses. Now you can convert your air hammer into a pneumatic slide hammer with the Big Nasty Texas Twister™. Simply snap the Big Nasty Texas Twister™ curved air bit into the collet of your hammer with one of the bits attached. Reverse the air hammer handle in your hand now using thumb to push the hammer trigger. Feel the 3000 air hammer blows per minute turning into new pulling power. One hand operation allows you to hold parts with your other hand. Safe controlled part removal without parts and fluids crashing to the floor. Use 21st century air hammer pulling power to get the job done SAFE, FAST & EFFICIENT instead of a slow, manually powered 19th century slide hammer. Extend the reach of the tool by using the 20" extension. Includes two puller connectors - 1/2"-20 to 5/8" and 1/2"-20 to 3/4" to connect the Big Nasty Texas Twister™ to your 5/8" & 3/4" slide hammer bits and pullers. Includes the LT855A-18 Vise Grip Adaptor to connect your 7/16-14 thread vise grips to the Big Nasty Texas Twister™. Comes packaged in a custom plastic red display tray with a custom black ballistic nylon carrying case. Patent #7,036,211.

NEW PRODUCT



NEW PART ADDED



AIR HAMMER POWERED



Scan to see tool work!

LT855-AH Texas Twister™ - Bidirectional Air Hammer

First new air hammer since the invention of the air hammer. Use as a hammer or use as a puller - double duty air hammer. Just install the included air lock plug into quick release chuck in front of air hammer to convert to pneumatic puller. Works great with LT855A Texas Twister™ - Air Hammer Pulling Kit accessories. Unlimited applications in automotive, aircraft, marine repair, farm implement maintenance, manufacturing industries. Packaged in blow molded storage/display case. Includes air lock plug, quick release chuck, 1/4" NPT adjustable brass air flow regulator. Vibration dampening system for reduced user discomfort and fatigue. Patent #7,036,211.



LT855-AH-SK Texas Twister™ - Bidirectional Air Hammer Starter Kit

Bidirectional - use as air hammer or pneumatic slide hammer - 2500 BPM. Texas Twister™ Air Hammer Pulling Kit accessories included: 855-2A - 7" Seal Remover - Pulls seals, bearings, brake hubs, axles, diesel injectors and axle pinion flanges and much more, 855-5A - 7" Universal Flat Blade Puller - Use on engine pulleys, speed sensors, distributors. Pull body panels without breaking clips, 855-12 - 6" Double Male 1/2-x 5/8-18 Thread Connector - Use to attach your specialty pullers directly to the Texas Twister™ Air Hammer. Just install the included air lock plug into quick release chuck in front of air hammer to convert to pneumatic puller. Unlimited applications in automotive, aircraft, marine repair, farm implement maintenance, manufacturing industries. Packaged in blow molded storage/display case. Includes air lock plug, quick release chuck, 1/4" NPT adjustable brass air flow regulator. Vibration dampening system for reduced user discomfort and fatigue. Patent #7,036,211.



LT856 Texas Twister™ Dedicated Single Rod Universal Seal/Bearing Puller

27" one piece designed for maximum strength and power. Tool tip has a radius curve design to hold seals securely during removal. **NO MORE RIPPED SEALS AND HOUSING MARRING.** Forged and machined alloy steel, heat treated with non turning slots Works on 90% of all seals and race bearings. Air hammer powered for easy user control. Easy one man operation. Easy on and off. Patent #7,036,211.

AIR HAMMER POWERED



LT-840 Air Hammer Wrench Driver

Use your air hammer to drive your wrenches in difficult and hard to reach areas. Long reach - 19 1/2". Fits any wrench. Use on crank pulley bolts, fan clutches, and any inaccessible bolt or fastener. New and improved with no welding. Fully machined from bar stock steel.

AIR HAMMER POWERED



AIR HAMMER POWERED SHOCKIT™ CROWS FOOT & LINE WRENCH SETS FOR EASY ACCESS

Uses the force and vibration of an air hammer. Air hammer powered offset punch allows for use in tight places. Indexed holes designed to keep Shockit™ Punches from slipping off crows foot and line wrenches. 30% more steel, 30% stronger. Built to precise ISO 1174-2 DIN tolerances. Patent #7,677,143 and other patents pending. **NOW each set includes non-turning offset 8mm radius tip LT1910P 11" Standard Shockit™ Punch.** Must be used with Shockit™ Punches for maximum performance and warranty coverage.



Scan to see tool work!

NEW PRODUCTS
AIR HAMMER POWERED

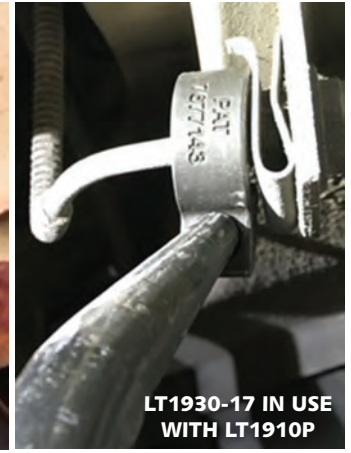

INDUSTRIAL/HYDRAULIC SHOCKIT™ CROWS FOOT SETS

Loosens hydraulic fittings on tractors, forklifts and heavy equipment. Fits into small spaces between hydraulic lines. Save time by only having to work on the hydraulic line that needs to be repaired. Hyper sonic vibration eliminates thread galling. NOW each set includes LT1910P 11" Standard Shockit™ Punch.

LT1900 10 Piece SAE Shockit™ Crows Foot Set

SET INCLUDES

- 3/4" 1-1/16"
- 13/16" 1-1/8"
- 7/8" 1-3/16"
- 15/16" 1-1/4"
- 1" 1-5/16"



NEW PRODUCT

LT1910 10 Piece Metric Shockit™ Crows Foot Set

SET INCLUDES

- 14mm 19mm
- 15mm 20mm
- 16mm 21mm
- 17mm 22mm
- 18mm 24mm



NEW PRODUCT

AUTOMOTIVE/HYDRAULIC SHOCKIT™ LINE WRENCH SETS

Loosens fittings on steering, brake, AC & fuel systems. No more subframe removal when working on steering rack hydraulic fittings or heat shield removal when working on ABS brake module hydraulic fittings. Hyper sonic vibration eliminates thread galling. NOW each set includes LT1910P 11" Standard Shockit™ Punch.

LT1920 13 Piece SAE Shockit™ Line Wrench Set

SET INCLUDES

- 1/4" 9/16" 13/16"
- 5/16" 5/8" 7/8"
- 3/8" 11/16" 15/16"
- 7/16" 3/4" 1"
- 1/2"



NEW PRODUCT

LT1930 12 Piece Metric Shockit™ Line Wrench Set

SET INCLUDES

- 6mm 10mm 14mm
- 7mm 11mm 15mm
- 8mm 12mm 16mm
- 9mm 13mm 17mm



NEW PRODUCT

LT1940 Series Kentucky Kicker Shockit™ Driver Kits

Apply air hammer vibration and torque to any impact socket. Utilize air hammer and punch to access inaccessible fasteners. Remove most stubborn nuts and bolts by repetitive hammering. Hyper sonic vibration eliminates thread galling. Square Drive Plug Breaker Bar allows breaker bar and air hammer simultaneous operation. Low Profile Drive Plug allows for use in tight spaces with an air hammer. Indexed holes designed to keep Shockit™ Punches from slipping off driver. **NOW each kit includes non-turning offset 8mm radius tip LT1910P 11" Standard Shockit™ Punch.** Patent #7,677,143 and other patents pending. Must be used with Shockit™ Punches for maximum performance & warranty coverage.

NEW PRODUCTS



Scan to see tool work!



AIR HAMMER POWERED



- LT1940-3/8 includes -**
- 3/8" Short Throw Shockit™ Driver
 - 3/8" Long Throw Shockit™ Driver
 - 3/8" Low Profile Drive Plug
 - 3/8" Drive Plug Breaker Bar
 - LT1910P 11" Standard Shockit™ Punch

- LT1940-1/2 includes -**
- 1/2" Short Throw Shockit™ Driver
 - 1/2" Long Throw Shockit™ Driver
 - 1/2" Low Profile Drive Plug
 - 1/2" Drive Plug Breaker Bar
 - LT1910P 11" Standard Shockit™ Punch

- LT1940-3/4 includes -**
- 3/4" Short Throw Shockit™ Driver
 - 3/4" Long Throw Shockit™ Driver
 - 3/4" Low Profile Drive Plug
 - 3/4" Drive Plug Breaker Bar
 - LT1910P 11" Standard Shockit™ Punch

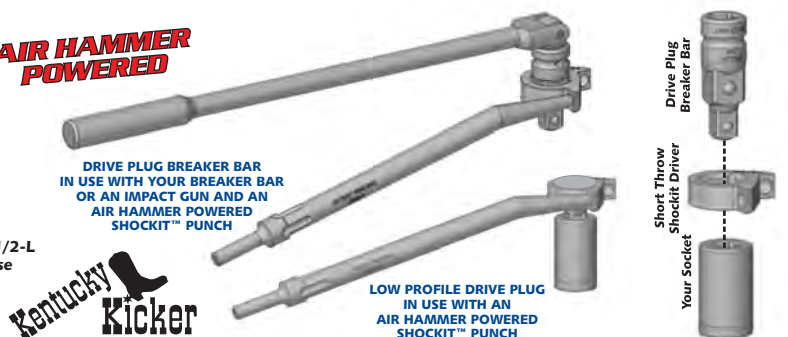

AIR HAMMER POWERED XL SHOCKIT™ CROWS FOOT & LINE WRENCH SETS FOR EASY ACCESS

Uses the force and vibration of an air hammer. Air hammer powered offset punch allows for use in tight places. XL sizes for XL applications. Indexed holes designed to keep Shockit™ Punches from slipping off crows foot and line wrenches. 30% more steel, 30% stronger. Built to precise ISO 1174-2 DIN tolerances. Each set includes non-turning offset 8mm radius tip LT1910P 11" Standard Shockit™ Punch. Must be used with Shockit™ Punches for maximum performance and warranty coverage. Additional Shockit™ Punches sold separately: LT1910PS - 5.5" Short and LT1910PL - 22" Long. Patent #7,677,143 & other patents pending.



XL SHOCKIT™ CROWS FOOT SETS INDUSTRIAL HYDRAULIC FITTINGS

Loosens hydraulic fittings on tractors, forklifts & heavy equipment "The Shockit™ Way"! Hyper sonic vibration eliminates thread galling. Fits into small spaces between hydraulic lines. Save time by only having to work on the hydraulic line that needs to be repaired. Reaches difficult line nuts with offset punch. Compact design fits where other wrenches won't.

XL SHOCKIT™ LINE WRENCH SETS INDUSTRIAL HYDRAULIC FITTINGS

Loosens hydraulic fittings on steering, brake, AC & fuel systems "The Shockit™ Way"! Hyper sonic vibration eliminates thread galling. Reaches difficult line nuts with offset punch. Compact design fits where other wrenches won't. No more subframe removal when working on steering rack hydraulic fittings. No more removing hydraulic fittings to work on the one that needs repair.

LT1900XL 16 Piece SAE Shockit™ Crows Foot Set



NEW PRODUCT

AIR HAMMER POWERED

INCLUDES SAE CROWS FOOT SIZES

1-3/8"	1-5/8"	1-7/8"	2-3/16"
1-7/16"	1-11/16"	1-15/16"	2-1/4"
1-1/2"	1-3/4"	2"	2-3/8"
1-9/16"	1-13/16"	2-1/8"	2-1/2"

LT1920XL 16 Piece SAE Shockit™ Line Wrench Set



NEW PRODUCT

AIR HAMMER POWERED

INCLUDES SAE LINE WRENCH SIZES

1-1/16"	1-5/16"	1-9/16"	1-13/16"
1-1/8"	1-3/8"	1-5/8"	1-7/8"
1-3/16"	1-7/16"	1-11/16"	1-15/16"
1-1/4"	1-1/2"	1-3/4"	2"

LT1910XL 16 Piece Metric Shockit™ Crows Foot Set



NEW PRODUCT

AIR HAMMER POWERED

INCLUDES METRIC CROWS FOOT SIZES

25mm	30mm	36mm	45mm
26mm	32mm	38mm	46mm
27mm	33mm	41mm	48mm
29mm	35mm	42mm	50mm

LT1930XL 16 Piece Metric Shockit™ Line Wrench Set



NEW PRODUCT

AIR HAMMER POWERED

INCLUDES METRIC LINE WRENCH SIZES

18mm	22mm	26mm	32mm
19mm	23mm	27mm	33mm
20mm	24mm	29mm	35mm
21mm	25mm	30mm	36mm

LT994 Shockit™ Socket O2 Sensor Removal Kit

Air hammer powered Shockit™ Sockets to access, loosen, and easily remove **frozen and obstructed O2 sensors and diesel NOx sensors**. Works when ratchets, wrenches and regular sockets don't fit. Hyper sonic vibration eliminates thread galling. **No more catalytic converter removal or dropping motor mounts to access O2 sensors**. Includes 22mm low profile design for limited access and 22mm long profile design for deep recessed Ford®, Toyota® and Lexus® applications. Removes 22mm diesel NOx sensors on Kenworth®, Cummins®, International®, Detroit and Volvo® diesel truck engines. Includes non-slip self centering air hammer powered offset 11" Standard Shockit™ Punch for limited access applications. Includes 18mm dual sided tap/bottoming die for O2 sensor and mounting hole threads. Dual ear socket design for 90° rotation without repositioning socket. Engineered to precise German DIN standards. Must be used with Shockit™ Punches for maximum performance and warranty coverage. Additional Shockit™ Punches sold separately: LT1910PS - 5.5" & LT1910PL - 22". Patent #7,677,143 & other patents pending.



AIR HAMMER POWERED

NEW PRODUCT

PARTS LIST & SIZES

LT994-1	22mm SHORT SOCKET
LT994-2	22mm DEEP SOCKET
LT994-3	18mm THREAD CHASER
LT1910P	11" STANDARD PUNCH



Scan to see tool work!



LT996D Shockit™ Socket Diesel Nox & Particulate Sensor Removal Kit

Removing rusted and obstructed diesel NOx and particulate sensors doesn't have to be an expensive and time consuming problem anymore. Air hammer powered Shockit™ Sockets for removing diesel exhaust sensors. Compact sizes for reaching sensors with restricted access. Uses the force and vibration of an air hammer to loosen the most rusted sensors. Includes non-turning offset 8mm radius tip LT1910P 11" Standard Shockit™ Punch. Force and vibration of air hammer allows most sensors to be removed without thread galling. Each Shockit™ Socket has 3 driving ears w/ 8mm indexed holes for delivering maximum rotational force. **Each Shockit™ Socket has 3 driving ears with 8mm indexed holes for tightening and loosening, allowing the most stubborn sensors to be worked back and forth during removal.** 22mm Shockit™ Socket removes NOx sensors on Chevy® Duramax, Dodge® Cummins, Ford® Power Stroke. Also removes most Semi Truck NOx sensors including Kenworth®, Cummins®, International®, Detroit & Volvo®. 22mm Low Profile Shockit™ Socket for delivering maximum rotational force and minimum side loading for extremely stuck NOx sensors. 22mm Thin Wall Deep Shockit™ Socket removes NOx sensors on Jeep® and RAM® ECO Diesel. 24mm Shockit™ Socket removes Particulate Sensors (Soot Sensors) on Chevy® Duramax, Dodge® Cummins and Ford® Power Stroke. 24mm Low Profile Shockit™ Socket for delivering maximum rotational force and minimum side loading for extremely stuck particulate sensors. 30mm Shockit™ Socket removes the NOx sensor lock nuts on Jeep® and RAM® ECO Diesel. Includes 20mm, 22mm & 27mm bottoming tap and dies for sensor and mounting hole threads. Must be used with Shockit™ Punches for maximum performance and warranty coverage. Additional Shockit™ Punches sold separately: LT1910PS - 5.5" & LT1910PL - 22". Patent #7,677,143 and other patents pending.

AIR HAMMER POWERED

NEW PRODUCT

PARTS LIST & SIZES

LT996-1	22mm SHOCKIT™ SOCKET
LT996-2	24mm SHOCKIT™ SOCKET
LT996-3	30mm SHOCKIT™ SOCKET
LT996-4	22MM THIN WALL DEEP SHOCKIT™ SOCKET
LT996-5	20MM THREAD CHASER
LT996-6	22MM THREAD CHASER
LT996-7	27MM THREAD CHASER
LT996-8	22MM LOW PROFILE SHOCKIT™ SOCKET
LT996-9	24MM LOW PROFILE SHOCKIT™ SOCKET
LT1910P	11" STANDARD SHOCKIT™ PUNCH

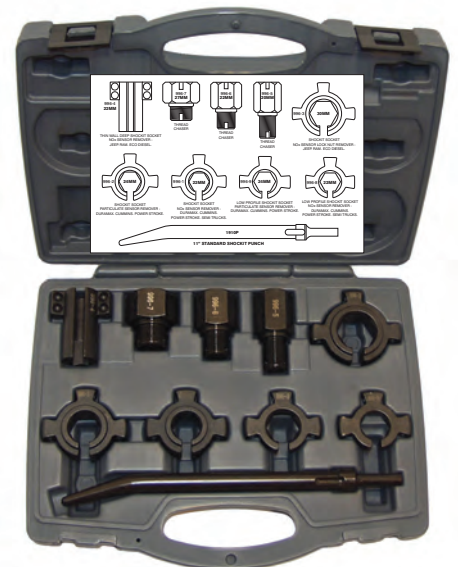

Scan to see tool work!



996-9



996-4



996-3

LT1910PK Shockit™ Punch Kit

8mm radius Shockit™ Punch tips are designed to fit precisely into indexed holes on all Shockit™ tools for maximum performance and warranty coverage. Non-turning slots. Offset design for greater access. Individual Shockit™ Punches also sold separately. Patent pending.



Kit includes: LT1910P 5.5" Short Shockit™ Punch
LT1910P 11" Standard Shockit™ Punch
LT1910PL 22" Long Shockit™ Punch

**AIR HAMMER
POWERED**

**NEW
PRODUCT**

LT1910PS 5.5" Short Shockit™ Punch



LT1910P 11" Standard Shockit™ Punch



**NEW
PRODUCTS**

LT1910PL 22" Long Shockit™ Punch



LT1800 4 Piece Offset Impact Driver Set

410, 530 & 725 drivers have a 15° offset angle for greater access in tight areas. Recessed non-turning well head prevents driver slipping off stud or fastener. 990 straight 8" extra-long non-turning straight hammer head won't rotate off stud. Great for strut work, hub work, front end, exhaust, spring and suspension repair. Comes packaged in a heavy duty roll-up cordura nylon storage bag. Includes 410, 530, 725 & 990.



LT1810 2 Piece Offset Impact Driver Set

Our two most popular impact drivers. 725 has 15° offset machined recessed well head to remove and install hard to reach stud and bolts. 990 straight 8" extra-long hammer head with non-turning slots won't rotate off work area. Ideal for under the car, struts, front end, exhaust, suspension and spring repair. Comes packaged in a heavy duty roll-up cordura nylon storage bag. Includes 725 & 990.

Individual Impact Drivers:

410 - Offset Shaft Impact Driver



530 - Offset Shaft Impact Driver



725 - Offset Shaft Impact Driver



990 - Straight Shaft Impact Driver



990SHT - Short Straight Shaft Impact Driver



LT1820 3 Piece Offset Impact Driver Set

990 straight 8" extra-long non-turning slotted air hammer. 990SHT 6" short non-turning slotted air hammer. 725 offset .812 machined recessed well head to remove/install hard to reach studs and bolts. Comes packaged in a heavy duty roll-up cordura nylon storage bag. Includes 725, 990 & 990SHT.

LT1830 2 Piece Non-Turning Hammer/Impact Hammer Driver Set

990 straight 8" long non-turning slotted air hammer and 990SHT straight 6" short non-turning slotted air hammer. Non-turning machined slots won't rotate off work area. Comes packaged in a heavy duty roll-up cordura nylon storage bag. Includes 990 & 990SHT.



AIR TOOLS

MISCELLANEOUS

LT886 Radiator Rocket Coil & Line Cleaner

Clean cooling coils for radiators, transmission lines, oil and fuel lines. Clean air to air aftercoolers, condensers, evaporators, fluid coolers and much more. Ideal for transport, municipal, agriculture, industrial, trailer truck, dump truck, HD trucks, earth moving and tractor vehicles. Use the Radiator Rocket and you will be surprised how dirty your "clean" radiator is. **CAN ALSO BE USED WITH WATER - NOW INCLUDES 3/4" X 1/4" NPT BRASS WATER HOSE ADAPTOR.** Can be configured in 3 foot or 2 foot lengths eliminating need for vehicle jacks or lifts to access buried coils. Four inch air slot for maximum air cleaning volume and pressure. Able to access gaps of 1" with brush, .7" without brush for access to space constrained coils. Use up-close without fear of air pressure bending fins. Designed for shop or field use. Includes 1/8" NPT air control valve. Patent Pending.



NEW PRODUCT



Scan to see tool work!

THIS ROCKET RUNS ON AIR POWER!

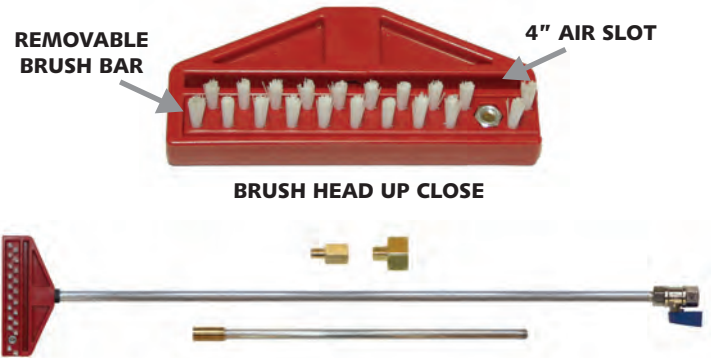

LT2650 Transmission Popper

Shifts transmissions into neutral from under hood with no key. Use pry bar fork end to separate transmission shift cable from transmission selector gear. Slide hole on end of pry bar over shift cable retaining pin on transmission selector gear to move selector gear into NEUTRAL position. Great for moving or towing vehicles with no key. Must have tool for auto recovery. 24" long with angled tip for easy operation. Two tools in one - use fork end of tool to pop out body panel grommets.



Scan to see tool work!



LT265 Dual Sided Universal Oil Cap Removal Tool

Oil caps on Toyota, Nissan, Hyundai and many imports are made of plastic and are the most difficult to remove. Easily removes oil caps without damaging them. Slotted end fits Toyota and most single fin caps. Double prong side fits into slotted notched sides of Nissan caps. Use it every day checking and changing oil.



LT-230 Magnetic Nut Holder

The LT-230 Magnetic Nut Holder has a flexible stainless steel body with pivoting magnetic head to reduce the risk of losing hard to reach nuts. Clips onto open and box end wrenches. The LT-230 Magnetic Nut Holder fits 3/8" - 3/4" and 10mm - 19mm wrenches. Also available in 12 pack display (LT-230-12).



LT991 Hollow End Line Taps

PROBLEM: A/C and hydraulic line fitting threads become corroded over time and are damaged in disconnect process requiring complete line removal to repair.

SOLUTION: Hollow end line taps rethread female fittings without line removal. Hollow end tap slides over flared end of line easily, rethreading female connector.

Use on A/C, brakes, oil, trans and heater lines and coils.



8 piece kit covers all popular sizes:

14MM	22MM
16MM	24MM
18MM	27MM
20MM	1 1/8"



A/C SERVICE



LT-860 Magnetic Rechargeable Screwdriver Holster

Holds two rechargeable screwdrivers. Conveniently store your rechargeable screwdrivers near work area at all times. Securely mounts to any metal surface. Holds up to two of any popular rechargeable screwdrivers. Readily access your rechargeable screwdrivers at any time.



LT-870 Magnetic Air Hose Holder

Holds 3/8" - 1/2" shop air hose. Attaches to any metal surface close to work area. No more air hoses on floor for car to run over. No more searching and reaching for air hose. Great aid for retractable air hoses.



LT998 Hose Clamp

PROBLEM: Most mechanics have hose clamp removal tools. However, they don't work if they can't reach the compression tips of the hose clamp. This occurs often when the clamp is put on erratically at the factory or by another mechanic.

SOLUTION: Our hose clamp pliers reach around the hose to encapsulate the clamp compression tips. Our tool allows the mechanic to easily rotate the clamp to a position where he can now use his clamp removal tool or remove clamp using our tool.



NEW & IMPROVED HANDLE



LT730 Subaru Axle Pin Removal Tool

The LT730 removes and installs roll pins for easy axle removal. This tool has a magnetized tip to help the roll pin from falling into hidden access areas around axle. The magnetized tip holds new roll pin for easy alignment and insertion into new axle. Works on all AWD Subaru trans-axle assemblies.



LT999 SAE Thread Chaser Socket Kit

NEW PRODUCT

Recondition threads on SAE high pressure male/female fittings. Hollow end tap slides over flared end of line for easy re-threading female connector. Compact design with pass through bored out center hole on each socket. Allows thread reconditioning with flared tip supply line inside pressure fitting. Ideal for gas, A/C, and liquid high pressure fittings common in heavy equipment, trucking, marine and aircraft industries. Easy hand operation with supplied handle.

INCLUDES SIZES:

- 5/8 - 18 UNF
- 3/4 - 16 UNF
- 7/8 - 14 UNF
- 1 - 14 UNF
- 1 1/16 - 14 UNF



LT999-5
up close



LT940 Gas Tank Fuel Pump Removal Tool

This tool removes plastic fuel pump retaining rings. Universal adjustable design fits most plastic retaining rings. **Increased length of ears and slots in ears allow for wider application for more secure fit when grabbing teeth around fuel pump retaining rings.** Prevents damage to original retaining ring. Use with a 1/2" drive extension and ratchet. Use to re-install old retaining ring.



LT740 Funnel Lok™

The Funnel Lok™ hands-free funnel holder is a simple, yet revolutionary tool designed to hold any standard-size funnel firmly in place--making it easy to transfer gasoline, oil, coolant, or any other fluids and powders without slipping or spilling. Provides a stable "third hand". Shaped like a pair of pliers with spring torque action, the Funnel Lok™ features four stabilizing prongs that can be inserted into any container or tank opening from 1 1/4" to 2 1/4" in size. This creates a steady base for the funnel to be held securely in place by the adjustable rings. Made of durable ABS material. Allows the air to vent, which eliminates the risk of blow back. It not only prevents spills of potentially hazardous chemicals, but its hands-free design allows containers to fully drain.



PAINT & BODY

LT-900 Magnetic Spray Gun Holder

The LT-900 Magnetic Spray Gun Holder will hold any cup or gravity fed spray gun without creating holes in your spray booth. The tubular design mounts to any flat steel surface with a 160 lb. magnetic force. The LT-900 is totally portable - hang it anywhere, move it any time and keep your spray booth brand new and hole free. Not just for spray booths. The LT-900 is an all purpose magnetic holder for use on your tool box or anywhere else in the shop.



LT790 Shape Tip™ Tool

The LT790 is designed to fit securely on most pry bars. Use to roll out high spots, creases and crowns around dents. Accurately roll and massage out dents and distortions without leaving tool marks. Excellent for use with today's thin alloy metal. Great for applying tape seam sealer. Repair bumpers, glue upholstery and patch tires.

