



SOLAR OVERLANDER

USER MANUAL

Model: SD-SO-27W-G1

20004

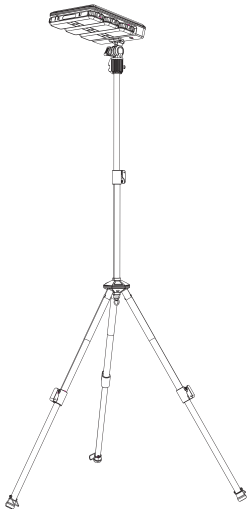

www.SeeDevil.com

info@SeeDevil.com

[877-659-5479](tel:877-659-5479)
TOLL FREE NUMBER

[@SeeDevilLights](https://www.facebook.com/SeeDevilLights)

[@SeeDevil.Lighting](https://www.instagram.com/SeeDevil.Lighting)

Introduction

Thank you for purchasing this Solar Overlander.

Functions and Applications

1. Outdoor

The whole lamp's overall lumen output is around 3500lm. Equipped with height adjustable tripod, it can provide lighting on demand for massive areas, such as work sites, camp sites, gardens and outdoor events.

2. Powerbank

Each portable light has a 5000mAh battery, and 1 USB port for power output, rated at DC5V 1A. The master charging station does not have any batteries, instead it has a USB output port (MAX.5V 1A). The charging mode for mobile device works only if it has external power input (Solar charging or DC12V adapter)

3. Working light

All portable lights can be operated as solo working lamps.

Technical Data

Battery Capacity:	Single portable lamp 3.7V 5000mAh Whole lamp*3=15000mAh
Power:	Single lamp 9W
Luminous Flux:	Single lamp 1150lm, whole lamp*3=3450lm
Light Power:	1.2W/2.5W/5W
Light Lumen:	1200lm/380lm/900lm
Spotlight Power:	4.5W
Spotlight Lumen:	520lm
USB input:	5V 3A
USB Charging Time:	12H
Solar Charging Time:	24H
Duration Time:	2H~14H
Operating Temperature:	0°C~45°C
Operating Humidity:	≤95%
Shell Material:	ABS
IP:	IP44
Lifespan:	20000Hours
CCT:	6500K
CRI:	Ra80

Product Diagram

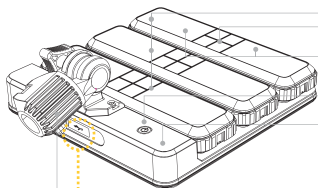

Detachable lamp (x3)

Spotlight

Flood light (x2 per light)

Master switch

Master charging station

The Master charging station does not have any batteries, instead it has one USB output port (MAX.5V 1A). The charging mode for mobile device works only if it has external power input (Solar charging or DC12V adapter)

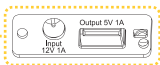

Charging indicator

Green - if charging via DC12V

Red - if charging via solar

Tripod adapter knob

Adjust the lighting angle by adjusting the knob. Please fasten the controller once lighting angle is in the desired position.

Solar Panel

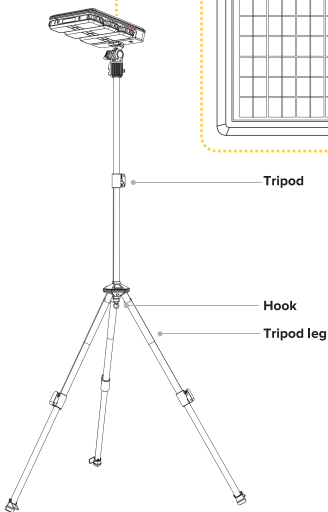
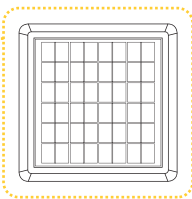

Tripod

Hook

Tripod leg

Hook

Hotshoe

Master switch

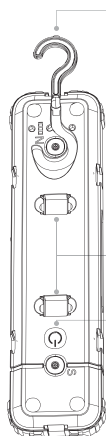

Package Contents:

Portable lamp (x3), master charging station, tripod adapter, tripod axis, tripod leg (x3) ground nails (x3), reinforced bag, USB adapter, hanging rope, user manual.

Installation — Hotshoe

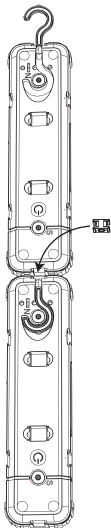
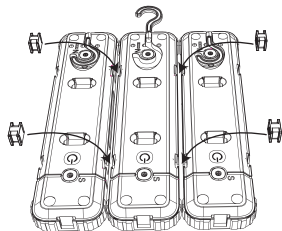

Installation — Hanging Rope

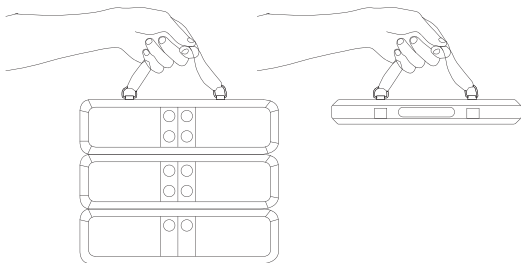

Installation — 1/4" Tripod Thread Adapter

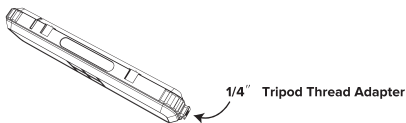

Installation — Tripod Assembly

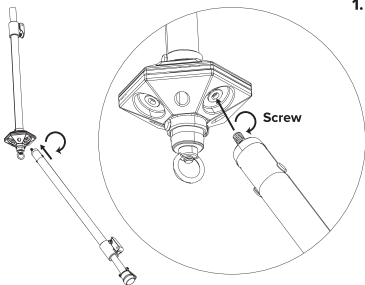

- 1. Assemble tripod** by screwing legs into tripod axis.

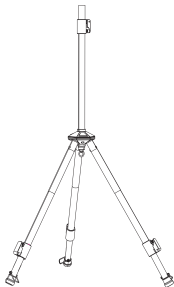

- 2. Tripoid installation complete.**

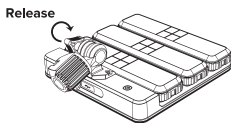

- 3. Adjust the lighting angle** to the ideal position, then fasten the knob.

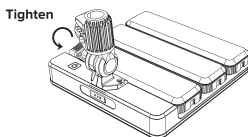

Installation — Tripod Assembly

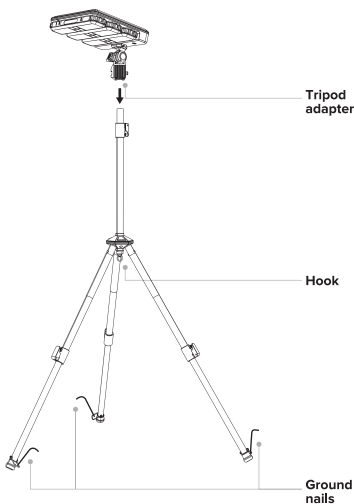

- 4. Place tripod adapter on tripod and tighten clasp. Adjust tripod height.**

- 5. Secure tripod with ground nails and/or hanging sandbags/heavy items on hook.**

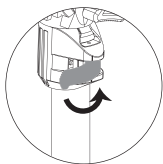

Open
Clasp

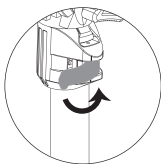

Tighten
Clasp

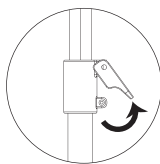

Adjust
tripod
height

Operation of Master Switch

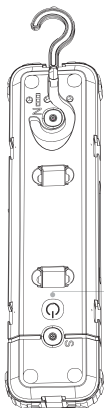

1. ON/OFF

Long press

2. Change Mode

Slow short press to change modes

1 x Short press: Flood light low

2 x Short press: Flood light medium

3 x Short press: Flood light high

4 x Short press: Spot light

5 x Short press: Spot light and flood light

3. SOS/Reset

Quick double press for SOS and reset all 3 lamps to the same lumen

Charging

1. Portable lights can be recharged on the Master Charging Station
2. DC 12V adapter
3. Solar Power charging, suitable for outdoor use
4. It has built-in micro-USB port for recharging, input rate DC 5V, 1A

* The charging indicator light flashes red on solar charging, and green on DC12V adapter. It stays green once fully charged.

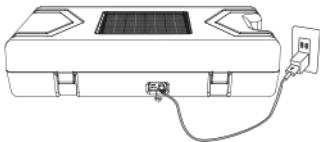
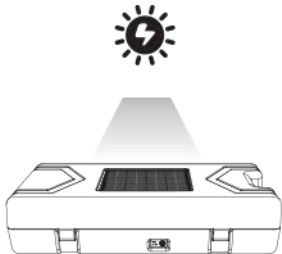

Warranty & Customer Service Support

Thanks for purchasing our Solar Overlander.



If you have any questions or issues, please email our customer service team at:

info@SeeDevil.com
Rezek Engineering
970 Reece Street, San Bernardino, CA 92411

The SD-SO-27W-G1 is covered with a warranty of 24 months from the date of its original purchase.

**For more information on applications
and Solar Overlander use visit SeeDevil.com**



 www.SeeDevil.com  info@SeeDevil.com  **877-659-5479**
TOLL FREE NUMBER

 @SeeDevilLights

 @SeeDevil.Lighting

CAUTION

1. Please use the appropriate power supply, do not use chargers that are not matched.
2. Be cautious when using adjustable tripod. Please use sandbags and ground nails to stabilize tripod and avoid collapse.
3. Please recharge the lamp every 3 months if not in use.
4. The waterproof cover for USB port must be closed if not in use.
5. Product contains Liquified Lithium-Ion battery, please do not put this product into fire.
6. When the lamp flashes 12 times per minute in lowest reading mode it means the battery is running low. Please recharge the lamp.

  **RoHS IP44**  

Made in China