

WiFi Digital Photo Frame with Touchscreen LCD Display

Instructional Manual



Table of Contents

Frame Features: 7" Frame	04
Frame Features: 8" / 10" Frame	06
Frame Features: 9" Frame	08
Frame Features: 15" Frame	10
Frame Features: 15.6" / 17.3" Frame	12
7" / 8" / 10" Frame Control Close-up	14
Package Contents	15
Getting Started	15

Operating Instructions

Configure Aluratek Smart Frame APP to Frame.....	16
Create Playlist / Folder	25
Multi Picture Slideshow Display	27
How to Email Photos to the Frame	28
Bind Additional Users to Your Frame Using the App	29
Link to Facebook	30
Link to Twitter	33
Transfer Pictures Directly From Your Computer To The Frame (Windows)	35

Table of Contents

Main Menu Function

Main Menu	37
-----------------	----

Album Function

Album Settings	38
----------------------	----

System Function

System Settings	40
-----------------------	----

Alarm Function

How To Set Alarm	42
------------------------	----

Technical Support	43
-------------------------	----

Radio and TV Interference Statement	44
---	----

Warranty	45
----------------	----

Frame Features: 7" Frame

- 1 7" IPS LCD Touchscreen
- 2 Frame
- 3 SD/SDHC Card Slot
- 4 Power Adapter Port
- 5 USB 2.0 Ports
- 6 Menu Button
- 7 Directional Keypad
- 8 Power Button
- 9 Wall Mount Hole
- 10 Speakers
- 11 Security Lock
- 12 Frame Stand

- A Connect a USB hard drive, USB flash drive or SD/SDHC card to easily access and share your favorite pictures, music, or videos.
- B Transfer and store files quickly and easily to the frame's 8GB built-in memory.

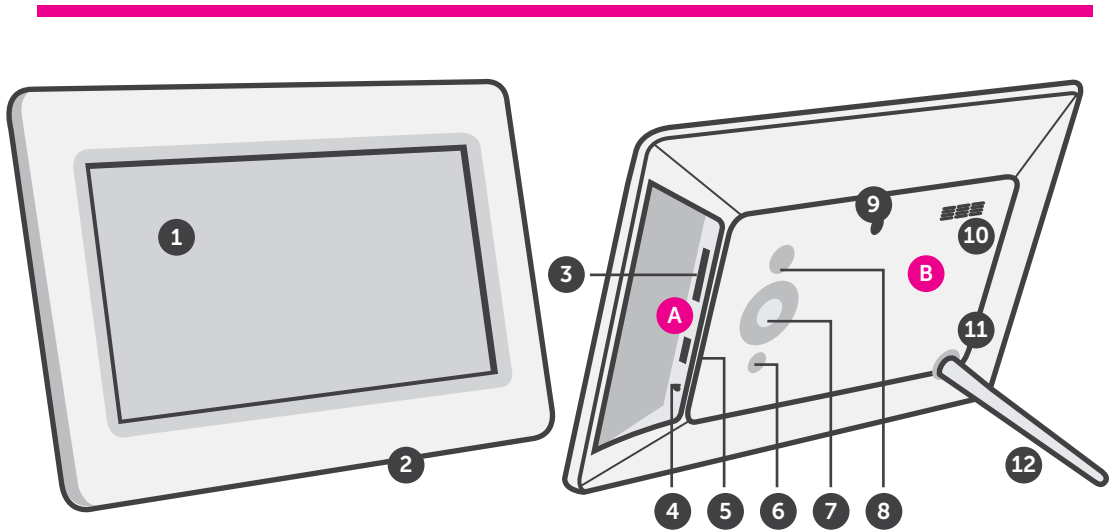

Frame Features: 8" / 10" Frame

- 1 8" / 10" IPS LCD Touchscreen
 - 2 Frame
 - 3 SD/SDHC Card Slot
 - 4 Power Adapter Port
 - 5 USB 2.0 Ports
 - 6 Menu Button
 - 7 Directional Keypad
 - 8 Power Button
 - 9 Wall Mount Hole
 - 10 Speakers
 - 11 Security Lock
 - 12 Frame Stand
- A** Connect a USB hard drive, USB flash drive or SD/SDHC card to easily access and share your favorite pictures, music, or videos.
- B** Transfer and store files quickly and easily to the frame's 16GB built-in memory.

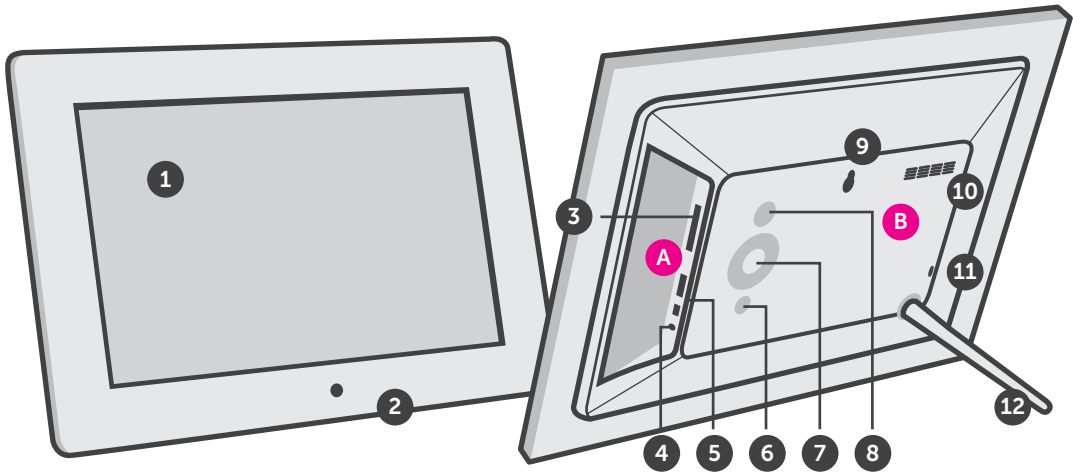

Frame Features: 9" Frame

- 1 9" IPS LCD Touchscreen
 - 2 Black Matte Frame
 - 3 Motion Sensor
 - 4 microSD Card Slot
 - 5 Power Adapter Port
 - 6 MicroUSB Port
 - 7 Speakers
- A** Insert a microSD card to easily access and share your favorite pictures, music, or videos.
- B** Transfer and store files quickly and easily to the frame's 16GB built-in memory.

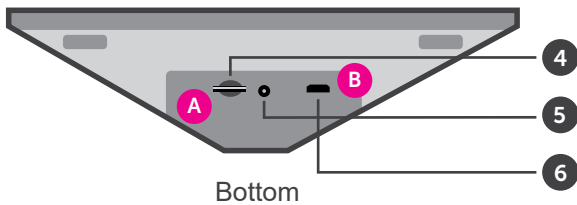
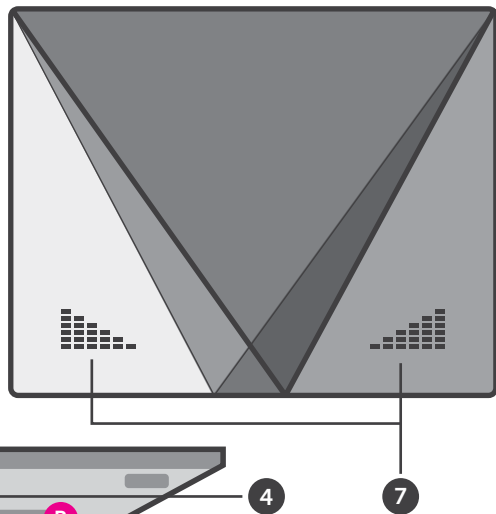
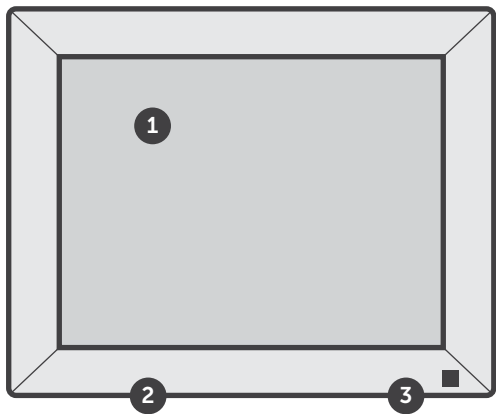

Frame Features: 15" Frame

- 1 15" LCD Touchscreen
- 2 Black Matte Frame
- 3 Motion Sensor
- 4 Speakers
- 5 Wall Mount Hole
- 6 Frame Stand
- 7 Security Lock
- 8 microSD Card Slot
- 9 Power Adapter Port
- 10 USB Port
- 11 MicroUSB Port

A Insert a microSD card to easily access and share your favorite pictures, music, or videos.

B Transfer and store files quickly and easily to the frame's 32GB built-in memory.

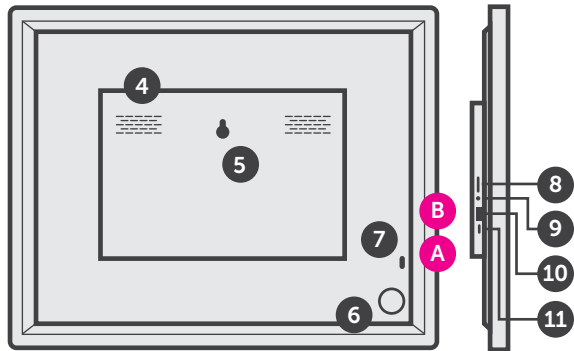
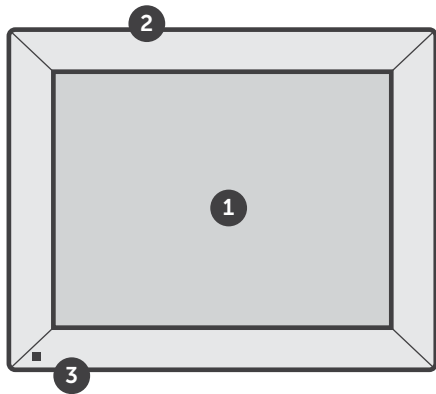

Frame Features: 15.6" / 17.3" Frame

- 1 15.6" / 17.3" IPS LCD Touchscreen
- 2 Frame
- 3 Power Button
- 4 Wall Mount
- 5 Speakers
- 6 SD/SDHC Card Slot
- 7 Headphone Jack
- 8 Power Adapter
- 9 Mini USB Port
- 10 USB 2.0 Port
- 11 Security Lock
- 12 Frame Stand
- 13 Wall / VESA Mount

A Connect a USB hard drive, USB flash drive or SD/SDHC card to easily access and share your favorite pictures, music, or videos.

B Transfer and store files quickly and easily to the frame's 16GB built-in memory.

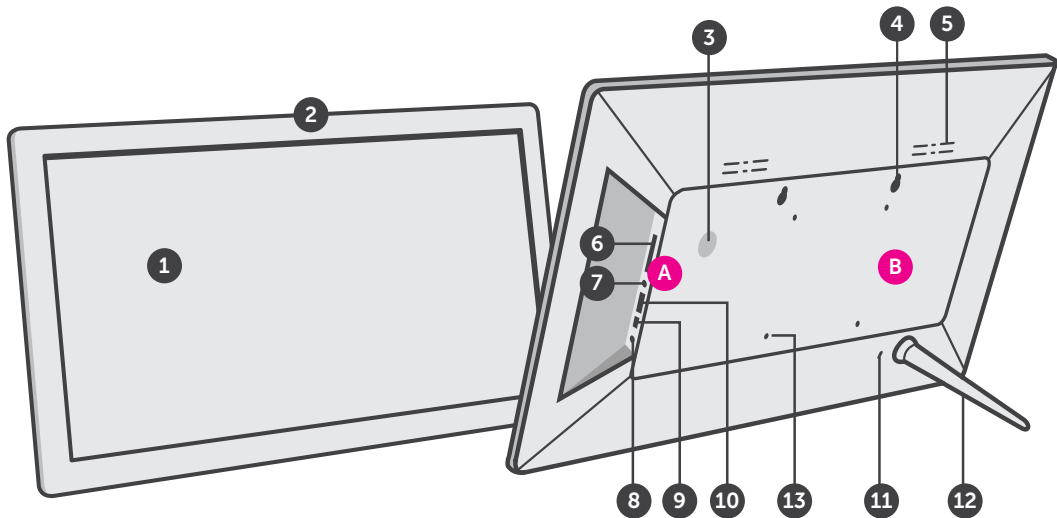

7" / 8" / 10" Frame Control Close-Up

1 -  Power On / Off

2 - Menu

(a) Press to return to previous screen

(b) Press & hold to return to Main Menu

3 -  Play / Pause

(a) Press to select option on Main Menu

(b) Press to pause slideshow, music or video

4 -  Up Arrow

(a) Press to navigate UP when selecting options

(b) Press to select Previous file (Photo & Music mode)

(c) Press & hold to Fast Forward

5 -  Down Arrow

(a) Press to navigate DOWN when selecting options

(b) Press to select Next file (Photo & Music mode)

(c) Press & hold to Scan Backward

6 -  Volume Up

(a) Press & hold to increase volume

7 -  Volume Down

(a) Press & hold to decrease volume

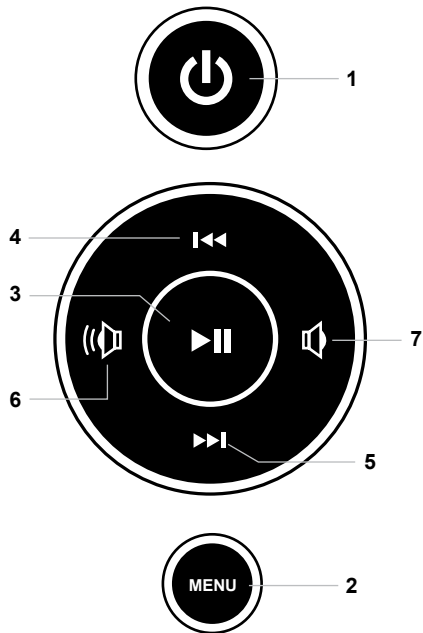

Package Contents

Your order has been carefully packaged and inspected. The following accessories should be included in your package. Please inspect the contents of the package to ensure that you have received all items and that nothing has been damaged. If you discover a problem, please contact us immediately for assistance.

USB 2.0 Cable, Power Adapter, Frame Stand*, Instructional Manual, Quick Start Guide

*Not applicable for 9" frame

Getting Started

- Screw in the frame stand (Not applicable for 9" frame)
- Plug in the power adapter

Power On: Connect your WiFi Frame to an AC outlet. The photo frame will power on

Connect to your WiFi

1. Select the WiFi connection utilizing the photo frame touch screen display.
(if required, enter the WiFi password)
2. "Connected" will appear below your selected WiFi network.
3. Press the arrow in the upper right corner to move to the next step

Operating Instructions

Configure Aluratek Smart Frame APP to Frame

Step 1: Download the ‘Aluratek Smart Frame’ APP to your Smartphone / Tablet

1. Go to the App store on your Apple or Anroid device and search for “Aluratek Smart Frame” then install and open. (Image 1 & 2)
NOTE: Make certain you download “Aluratek Smart Frame” and not “Aluratek WIFI Frame”
2. Tap “Complete” on the device info screen

Operating Instructions



Image 1

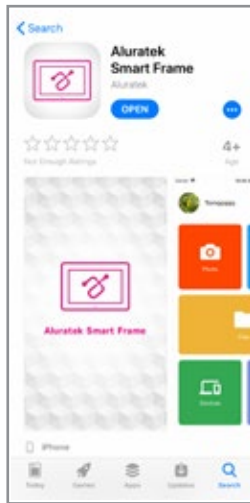

Image 2

Operating Instructions

Step 2: Creating Your Account in the APP

1. Open the “Aluratek Smart Frame” APP (Allow notifications if prompted)
2. Select “Sign Up” (Image 3)
3. Create “Username” “Password” (write this down as you will need it later)
4. Enter your email address then press the “Submit” button.
(Image 4 & 5)

Operating Instructions



Image 3

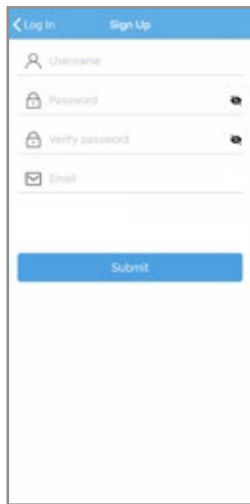

Image 4

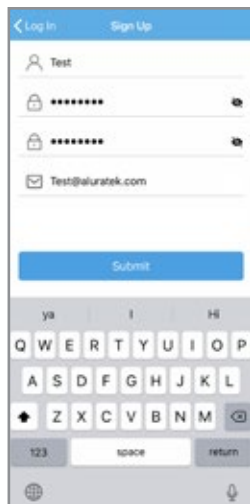

Image 5

Operating Instructions

Step 3: Bind Your Frame

1. Make sure you are signed in within the APP
2. Select “Devices” within the APP
3. Click the “+” next to My Devices (Image 6)
4. Enter a device Name that will help you identify this particular frame.
For example “Kitchen123”.
5. Create a unique email address name for your frame so you can email pictures / videos.
Tip: Make it unique using 6 or more characters including letters, numbers, and symbols. For example, Alexkitchen@wififrame.com (Image 7)
6. Enter your frame ID - this is found on your WiFi frame by selecting “Settings” then “Device info”. See “Frame ID:” xxxxxx at the top of the screen. (Image 8)
7. Enter your unique “Frame ID” into the field on the app. Your frame will notify you that a request has been sent to allow a user to bind to it. Touch “Accept” to bind.
8. On your digital frame go to “Settings” > “User Management” to see “Pending User Request” and touch “Accept”.
9. Your phone and frame are now connected!

Operating Instructions



Image 6



Image 7



Image 8

Operating Instructions

Step 4: Send Pictures from your Smartphone / Tablet to the frame using the Aluratek Smart Frame APP

1. Select the photo or video icon within the APP to take a live photo / video. If prompted to access the camera, please “Allow” access.
2. Select the “Files” icon to send a photo or video previously saved to your smartphone / tablet. Select the files you would like to send then click done. (Image 9)
3. Under “Push Device” Select the frame that you would like to send the files to. (Image 10)
4. Select the right arrow (send mail) icon to send. (Image 10)
NOTE: You can send up to 9 photos at a time to speed up the photo delivery to the frame.



Image 9



Image 10

Operating Instructions

Step 5: Enjoy Your Photos!

1. On the main screen on your photo frame - select the photos in the upper left box
2. Use the menu on the left to select the source for your photos typically, that is "ALL"
3. Tap a photo in the right column to start enjoying your photos.

Operating Instructions

Create Playlist / Folder

1. On the main screen on your photo frame - select the photos in the upper left box
2. Tap on Folder, then tap "+ New folder" to create a new folder

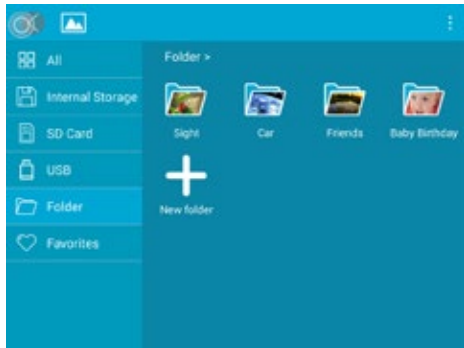

3. Once the folder is created, tap on Internal Storage to show the available pictures.



Operating Instructions

Create Playlist / Folder

4. Tap on  to enable the selection of the pictures. Tap on the picture to select it.



5. Once the pictures are selected, tap on the  folder icon on the top to add the pictures to the folder/playlist that you want.

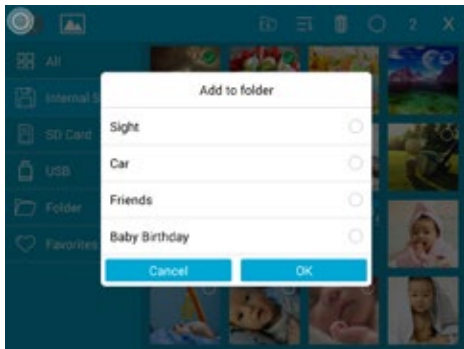

To play a slideshow of a particular playlist/folder, tap on Folder, then the folder that you want to display. Start the slideshow by tapping on any of the pictures in the folder.

Operating Instructions

Multi Picture Slideshow Display

During a slideshow, you can change the view to display 1-4 pictures simultaneously by tapping .

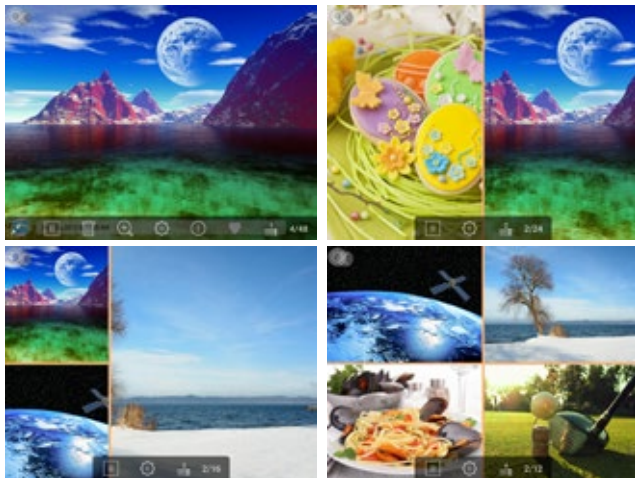

Operating Instructions

If you are the owner of the frame, the email address you used to bind the frame is already approved to send photos. You can verify by going to Settings > User Management, your email should be listed under users.

How to Email Photos to the Frame

1. Have your family or friend send an email with a subject line of bd123456 (if your frame id was 123456)
Example:
To: alexkitchen@wififrame.com
Subject: bd123456 (if your frame ID was 123456)
(Note: there is no need to add anything in the body of the email)
2. You must accept the user request on the frame by going to Settings > User Management.
3. Accept the user request by clicking Accept.
4. The email sender will receive a confirmation email with the subject line "Your Binding Request was Complete". This confirms they can now email photos to your photo frame.
5. To send photos to the frame the sender only needs to send an email to the frame and attach a photo. No subject line is necessary.

Operating Instructions

Bind Additional Users to Your Frame Using the App

1. Download Aluratek Smart Frame app from the app store on the additional user's smart device.
2. Create a new user account and login to the app.
3. Select "Devices" within the app.
4. Click the "+" next to "Bound Devices" (Image 11)
5. Enter a device name that will help identify this particular frame. For example: "Kitchen123"
6. Enter frame ID - this is found on your WiFi frame by selecting "Settings" then "Device info".
7. On your digital frame, go to "Settings" then "User Management" to see "Pending User Request" and touch "Accept".
8. Additional user is now connected!



Image 11

Operating Instructions

Link to Facebook

How to link the frame to your Facebook account so that you can send pictures to the frame via Facebook.

1. Open Facebook app or go to Facebook from your browser and login to your Facebook account if you are not logged in already
2. Search for “Aluratek WiFi Frame”



Operating Instructions

3. Send a message with your frame ID to bind the frame. For example, if your frame ID is 123456, please send "bd123456"

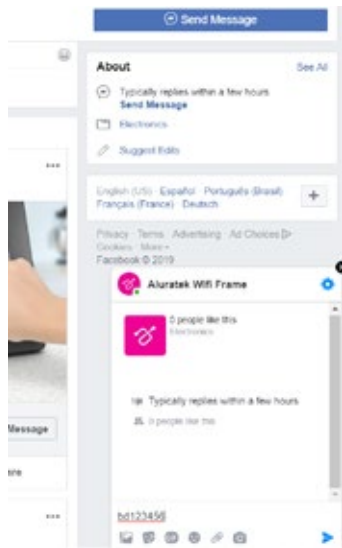

Operating Instructions

4. You will see the binding message, "Successful Binding!" once the binding is completed
5. You can now send pictures to your frame by just attaching a picture and send via message.



Operating Instructions

Link to Twitter

How to link the frame to your Twitter account so that you can send picture directly from your Twitter account to the frame.

1. Open Twitter app or go to Twitter from your browser
2. Search for “Aluratek WiFi Frame”
3. Click on “Follow”
4. Please login to your Twitter account. If you are already logged in on this computer, you will not need to login again and you will be directed to the next step directly.
5. Click “Message” to send a private message to link the frame.



Operating Instructions

6. Type '**bd+frame ID**' to bind. For example, if the frame ID is 123456, please type bd123456 in the message. Once the binding is successful, you will see a reply for confirmation.
7. Congratulations! Your Twitter account is now linked to the frame. To post a picture to your frame, you can just send a private message to the frame like below.

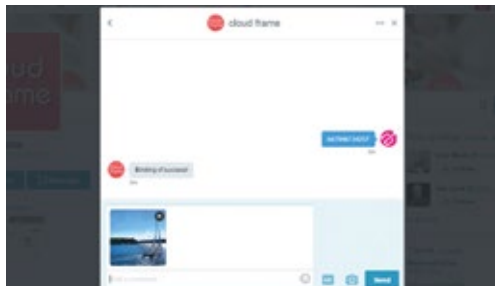
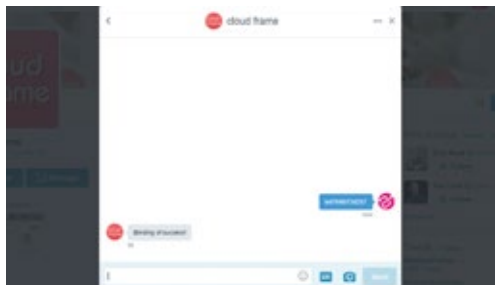

Operating Instructions

Transfer Pictures Directly From Your Computer To The Frame (Windows)

For Mac users, you will need to have an FTP client installed.

To transfer pictures from your computer to the WiFi frame directly, the frame and the computer will need to be on the same network. Follow the steps below to transfer the pictures.

1. Go to Settings > PC Control on the frame. Click “Start” to see the ftp address of the frame on the screen.

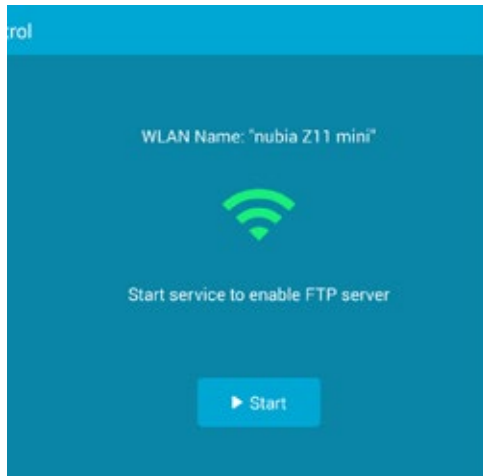

Operating Instructions

2. Go to your computer and open “File Explorer”. In the File Explorer, type in the exact address in the address bar. In this example, it is **ftp://192.168.0.100:2121**
3. The internal memory of the frame will show up as a folder on your computer. Drag and drop pictures you wish to transfer into this folder.
4. Once transferred, please go to Album > Internal memory of the frame to see the pictures.

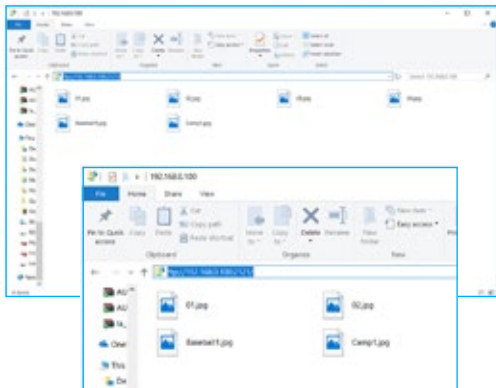

Note: If the computer and the frame is not on the same network, you can send / transfer the pictures to the frame via Facebook / Twitter or Aluratek Smart Frame app.

Main Menu Function

Main Menu

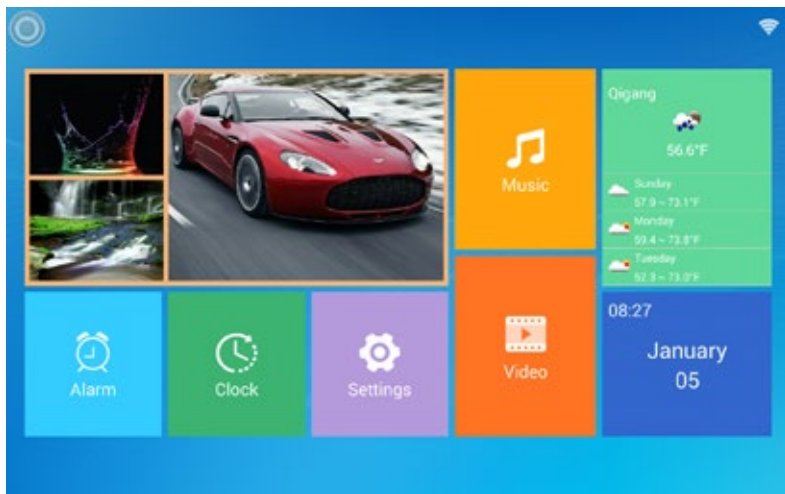

Album Function

Album Settings

1. From the main menu, tap on “Settings”.
2. Tap on “Album Settings”.

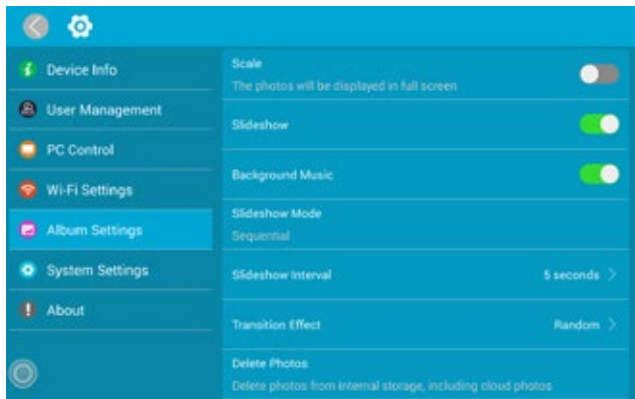

Album Function

Full Screen: Display photo in original size or to full screen.

Slideshow: If enabled, the slideshow will start automatically. based on the time selected. The slideshow will display pictures from the cloud media folder unless you are in the thumbnail page of the Internal memory or USB/SD Card folder then the slideshow will show pictures in those folders only.

Background Music: Set background music on / off

Slideshow Mode: Enable random pictures in slideshow mode.

Slideshow Transition Effect: Slideshow transition effect

Slideshow Interval: Slideshow time interval.

Delete Photos: Delete all photos from the cloud media and internal memory folders

Reset Default Settings: Reset all settings and disconnect all linked accounts without removing pictures in the cloud media and internal memory folders.

Sort by: Sort the sequential slideshow by name or time

Motion Sensor: Set motion sensor on/off

Auto-rotate screen: Set auto-rotate screen on/off

System Function

System Settings

1. From the main menu, tap on “Settings”.
2. Tap on “System Settings”.

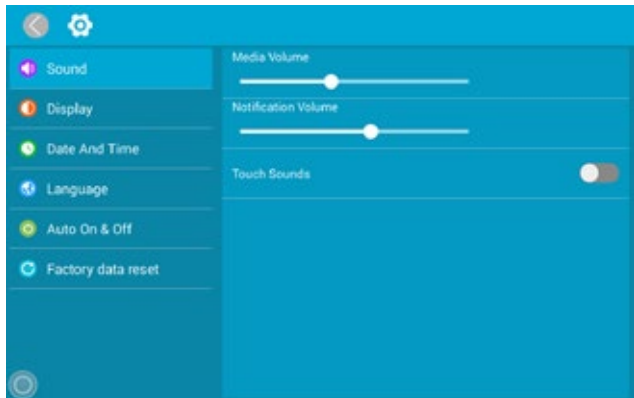

System Function

Sound: To adjust the media volume and notification volume, enable the touch sounds.

Display: To adjust the brightness of the display. Enable motion sensor (for 9" frame only)

Date and time: To set the date and time for the frame.

Auto ON / OFF: Enable the auto on / off feature.

Auto OFF: Set the time for the frame to auto power off.

Auto ON: Set the time for the frame to auto power on.

Factory data reset: Reset all data from the device's internal memory and the inserted SD card.

Alarm Function

How To Set Alarm

1. From the main menu, tap on “Alarm”.
2. To edit an existing alarm, tap on “Edit alarm” or tap “Add alarm” to create a new alarm.
3. Once you have set the days, time and ringtone of the alarm, tap OK to set the alarm.

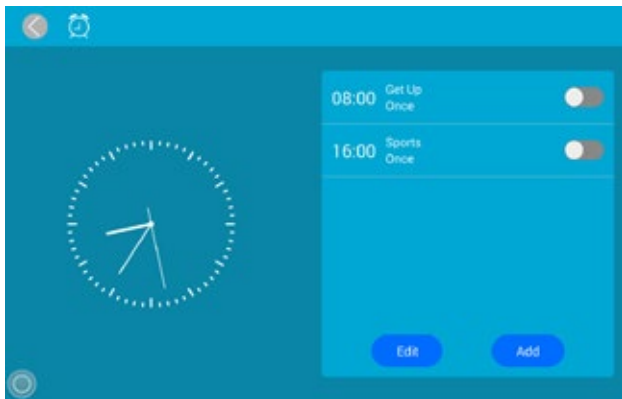

Technical Support

We are committed to providing the best customer service support. If you need assistance with your Aluratek product, please contact the Aluratek Technical Support department prior to returning this device. Reach out to us in any of the following ways:

E-mail: **support@aluratek.com**

Web: **aluratek.com/helpdesk**

Local (Irvine, CA): **714-586-8730**

Toll free: **1-866-580-1978**

Radio and TV Interference Statement

WARNING!!! This equipment has been tested and found to comply with the limits of a Class B digital device, pursuant to part 15 of the FCC rules. These limits are designed to provide reasonable protection against harmful interference in a residential installation

This equipment generates, uses and can radiate radio frequency energy and, if not installed and used in accordance with the instruction, may cause harmful interference to radio communications. However, there is no guarantee that interference will not occur in a particular installation. If this equipment does cause harmful interference to radio or television reception, which can be determined by turning the equipment off and on, the user is encouraged to try to correct the interference by whatever measures may be required to correct the interference.

Warranty

Aluratek warrants this product against defect in material or workmanship for **1 Year** from the date of purchase.

This warranty becomes invalid if the factory-supplied serial number or “warranty void” sticker has been removed or altered on the product.

This warranty does not cover:

- A) Cosmetic damage or damage due to acts of God
- B) Accident, misuse, abuse, negligence or modification of any part of the product.
- C) Damage due to improper operation or maintenance, connection to improper equipment, or attempted repair by anyone other than Aluratek.
- D) Products sold AS IS or WITH FAULTS.

IN NO EVENT SHALL ALURATEK'S LIABILITY EXCEED THE PRICE PAID FOR THE PRODUCT FROM DIRECT, INDIRECT, SPECIAL, INCIDENTAL, OR CONSEQUENTIAL DAMAGES RESULTING FROM THE USE OF THE PRODUCT, IT'S ACCOMPANYING SOFTWARE, OR IT'S DOCUMENTATION.

Aluratek makes no warranty or representation, expressed, implied, or statutory, with respect to it's products, contents or use of this documentation and all accompanying software, and specifically disclaims it's quality, performance, merchantability, or fitness for any particular purpose. Aluratek reserves the right to revise or update it's product, software or documentation without obligation to notify any individual or entity.

