



USER MANUAL

300 // CERAMIC HOB - KNOB

TCK30

IMPORTANT // Please ensure that you read through this user manual prior to installation and use. This manual contains important information to ensure optimal performance and keep you safe. Please retain your proof of purchase, as this will be required in the event that you require warranty service. Remember to retain this manual for future reference.

 **tisira**



www.tisira.com

HELLO

CONGRATULATIONS ON THE SELECTION OF THIS TISIRA APPLIANCE. TISIRA APPLIANCES HAVE BEEN SPECIFICALLY DESIGNED FOR AUSTRALIAN AND NEW ZEALAND KITCHENS.

Please read through this user manual carefully as it contains information that will ensure that your appliance is installed correctly, important operating & care instructions and also some advice of what you need to do if this appliance is not performing as intended.

CONTENTS

HELLO	2
CONTENTS	3
WARNING & SAFETY INFORMATION	4
PRODUCT OVERVIEW	6
ELECTRICAL CONNECTION	7
INSTALLATION	8-9
OPERATING INSTRUCTIONS	10
MAINTAINING YOUR COOKTOP	11
YOUR COOKWARE	12
PRODUCT SPECIFICATIONS	13
TROUBLESHOOTING	14
WARRANTY TERMS & CONDITIONS	15
CONTACT DETAILS	16

WARNING & SAFETY INFORMATION

INSTALLATION

ELECTRICAL SHOCK HAZARD

- Disconnect the appliance from the mains electricity supply before carrying out any work or maintenance on it.
- Connection to a good earth wiring system is essential and mandatory.
- Alterations to the domestic wiring system must only be made by a qualified electrician.
- Failure to follow this advice may result in electrical shock or death.

CUT HAZARD

- Take care - panel edges are sharp.
- Failure to use caution could result in injury or cuts.

IMPORTANT SAFETY INSTRUCTIONS

- Read these instructions carefully before installing or using this appliance.
- No combustible material or products should be placed on this appliance at any time.
- Please make this information available to the person responsible for installing the appliance as it could reduce your installation costs.
- In order to avoid a hazard, this appliance must be installed according to these instructions for installation.
- This appliance is to be properly installed and earthed only by a suitably qualified person.

- This appliance should be connected to a circuit which incorporates an isolating switch providing full disconnection from the power supply.
- Failure to install the appliance correctly could invalidate any warranty or liability claims.

OPERATION AND MAINTENANCE

ELECTRICAL SHOCK HAZARD

- Do not cook on a broken or cracked cooktop. If the cooktop surface should break or crack, switch the appliance off immediately at the mains power supply (wall switch) and contact a qualified technician.
- Switch the cooktop off at the wall before cleaning or maintenance.
- Failure to follow this advice may result in electrical shock or death.

HEALTH HAZARD

- This appliance complies with electro-magnetic safety standards.
- However, persons with cardiac pacemakers or other electrical implants (such as insulin pumps) must consult with their doctor or implant manufacturer before using this appliance to make sure that their implants will not be affected by the electromagnetic field.
- Failure to follow this advice may result in death.

HOT SURFACE HAZARD

- During use, accessible parts of this appliance will become hot enough to cause burns.
- Do not let your body, clothing or any item other than suitable cookware contact the ceramic glass until the surface is cool.
- Never leave metal objects (such as kitchen utensils) or empty pans on the cooktop as they can become hot very quickly.
- BEWARE // magnetisable metal objects worn on the body may become hot in the vicinity of the cooktop. Gold or silver jewellery will not be affected.
- Keep children away.
- Handles of saucepans may be hot to touch. Check saucepan handles do not overhang other cooking zones that are on. Keep handles out of reach of children.
- Failure to follow this advice could result in burns and scalds.

CUT HAZARD

- The razor-sharp blade of a cooktop scraper is exposed when the safety cover is retracted.
- Use with extreme care and always store safely and out of reach of children.
- Failure to use caution could result in injury or cuts.

IMPORTANT SAFETY INSTRUCTIONS

- Never leave the appliance unattended when in use. Boilover causes smoking and greasy spillovers that may ignite.
- Do not place or leave any magnetisable objects (e.g. credit cards, memory cards) or electronic devices (e.g. computers, MP3 players) near the appliance, as they may be affected by its electromagnetic field.
- Never use your appliance as a work or storage surface.
- Never leave any objects or utensils on the appliance.
- Never use your appliance for warming or heating the room.
- After use, always turn off the cooking zones

and the cooktop as described in this manual (i.e. by using the touch controls). Do not rely on the pan detection feature to turn off the cooking zones when you remove the pans.

- Do not allow children to play with the appliance or sit, stand, or climb on it.
- Do not store items of interest to children in cabinets above the appliance. Children climbing on the cooktop could be seriously injured.
- Do not leave children alone or unattended in the area where the appliance is in use.
- **WARNING** // This appliance is not intended for use by persons (including children) with reduced physical, sensory or mental capabilities, or lack of experience and knowledge, unless they have been given supervision or instruction concerning use of the appliance by a person responsible for their safety.
- **WARNING** // Children should be supervised to ensure that they do not play with the appliance.
- Do not repair or replace any part of the appliance unless specifically recommended in the manual. All other servicing should be done by a qualified technician.
- Do not use a steam cleaner to clean your cooktop.
- Do not place or drop heavy objects on your cooktop.
- Do not stand on your cooktop.
- Do not use pans with jagged edges or drag pans across the ceramic glass surface as this can scratch the glass.
- Do not use scourers or any other harsh abrasive cleaning agents to clean your cooktop, as these can scratch the ceramic glass.
- If the supply cord is damaged, it must be replaced by the manufacturer or its service agent or a similarly qualified person in order to avoid a hazard.
- Do not operate your cooktop by means of an external timer or separate remote-control system.
- This appliance is intended to be used in domestic households only.

PRODUCT OVERVIEW

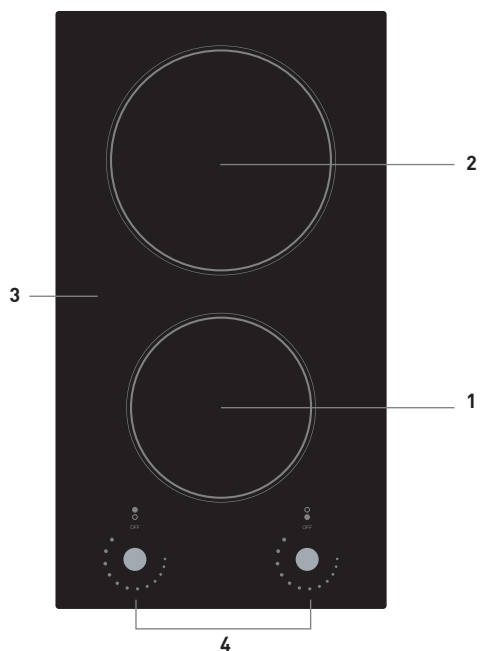

TOP VIEW

- 1. max. 1200 W zone
- 2. max. 1800 W zone
- 3. Glass plate
- 4. Knob Control

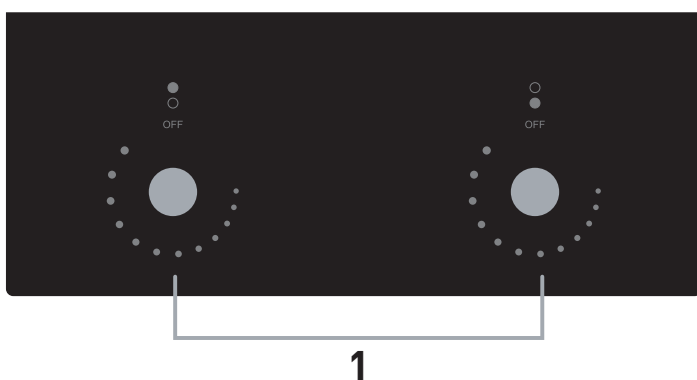

CONTROL PANEL

- 1. Power regulating controls

ELECTRICAL CONNECTION

CONNECTING THE HOB TO THE MAINS POWER SUPPLY

NOTICE // This appliance must be connected and installed in accordance with the manufacturers instructions.

Check that the power rating of the mains supply and of the sockets are suitable for the maximum power of the appliance as indicated on the specification plate. This appliance must be connected to a 220-240V 50Hz power supply. It is earthed via the cord and 15A plug.

IMPORTANT // Position the mains supply cable so that it is never subjected to a temperature which is more than 50°C above ambient temperature. The electrical safety of the appliance can only be guaranteed when it has been correctly connected to an efficient earthed power supply, as laid down in the regulations for electrical safety. The manufacturer cannot be held responsible for any damage to persons or objects due to lack of an earth connection. If the supply cord is damaged, it must be replaced by the service agent or similarly qualified person in order to avoid a hazard.

NOTICE // After installation, the electrical cable and the electrical power socket must be accessible.

INSTALLATION

Cut out the work surface according to the sizes shown in the drawing.

For the purpose of installation and use, a minimum of 50mm space shall be preserved around the hole.

Be sure the thickness of the work surface is at least 30mm. Please select heat-resistant work surface material to avoid larger deformation caused by the heat radiation from the hotplate. As shown below:

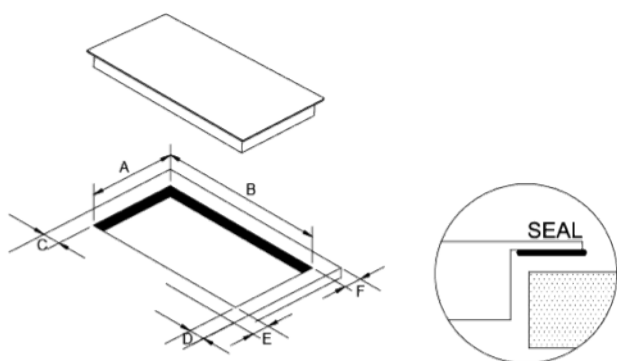

A	B	C	D	E	
268	500	Min 50	Min 50	Min 50	Min 50

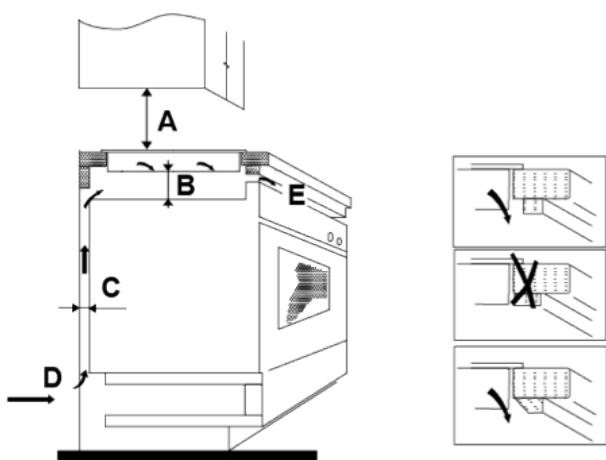

NOTICE // The safety distance between the hotplate and the cupboard above the hotplate should be at least 760mm.

A	B	C	D	E
760	Min 50	Min 30	Air intake	Air exit 10mm

INSTALLATION

Before locating the fixing brackets the unit should be placed on a stable, smooth surface (use the packaging). Do not apply force onto the controls protruding from the hob.

Fix the hob on the work surface by screw four brackets on the bottom of hob (see picture) after installation.

NOTICE // Adjust the bracket position to suit for different work surface's thickness.

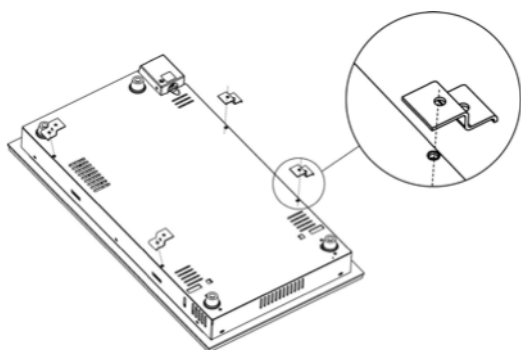

CAUTIONS //

- The ceramic cooker hob must be installed by qualified personnel or technicians. We have professionals at your service. Please never conduct the operation by yourself.
 - The ceramic cooker hob shall not be mounted to cooling equipment, dishwashers and rotary dryers.
 - The ceramic cooker hob shall be installed such that better heat radiation can be ensured to enhance its reliability.
-
- The wall and induced heating zone above the work surface shall withstand heat.
 - To avoid any damage, the sandwich layer and adhesive must be resistant to heat.
 - A steam cleaner is not to be used.
 - This ceramic can be connected only to a supply with system impedance no more than 0.427 ohm. In case necessary, please consult your supply authority for system impedance information.

OPERATING INSTRUCTIONS

TO START COOKING

1. Place a suitable pan on the cooking zone that you wish to use.

- Make sure the bottom of the pan and the surface of the cooking zone are clean and dry.

2. Adjust the power regulating control to the desired level to turn on the control

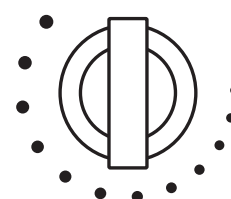
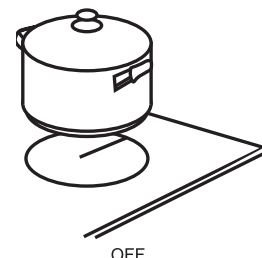

HOT HOB WARNING INDICATOR

When the glass plate is hot, the hot hob warning indicator will light. Don't touch the glass plate until the indicator goes out.

It can also be used as an energy saving function if you want to heat further pans, use the hotplate that is still hot.

WHEN YOU HAVE FINISHED COOKING

Turn the cooking zone off by turning the power regulating control to "OFF" to turn off the control.

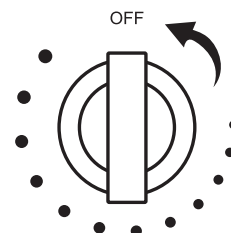

MAINTAINING YOUR COOKTOP

CLEANING & CARE

ISSUE?	SOLUTION	IMPORTANT
<p>Everyday soiling on glass (fingerprints, marks, stains left by food or non-sugary spillovers on the glass)</p>	<ol style="list-style-type: none"> 1. Switch the power to the cooktop off. 2. Apply a cooktop cleaner while the glass is still warm (but not hot!) 3. Rinse and wipe dry with a clean cloth or paper towel. 4. Switch the power to the cooktop back on. 	<ul style="list-style-type: none"> • When the power to the cooktop is switched off, there will be no 'hot surface' indication but the cooking zone may still be hot! Take extreme care. • Heavy-duty scourers, some nylon scourers and harsh/abrasive cleaning agents may scratch the glass. Always read the label to check if your cleaner or scourer is suitable. • Never leave cleaning residue on the cooktop: the glass may become stained.
<p>Boilovers, melts, and hot sugary spills on the glass</p>	<p>Remove these immediately with a fish slice, palette knife or razor blade scraper suitable for ceramic glass cooktops, but beware of hot cooking zone surfaces:</p> <ol style="list-style-type: none"> 1. Switch the power to the cooktop off at the wall. 2. Hold the blade or utensil at a 30° angle and scrape the soiling or spill to a cool area of the cooktop. 3. Clean the soiling or spill up with a dish cloth or paper towel. 4. Follow steps 2 to 4 for 'Everyday soiling on glass' above. 	<ul style="list-style-type: none"> • Remove stains left by melts and sugary food or spillovers as soon as possible. If left to cool on the glass, they may be difficult to remove or even permanently damage the glass surface. • Cut hazard: when the safety cover is retracted, the blade in a scraper is razor-sharp. Use with extreme care and always store safely and out of reach of children.

YOUR COOKWARE

CHOOSING THE RIGHT COOKWARE

Do not use cookware with jagged edges or a curved base.



Make sure that the base of your pan is smooth, sits flat against the glass, and is the same size as the cooking zone. Always centre your pan on the cooking zone.

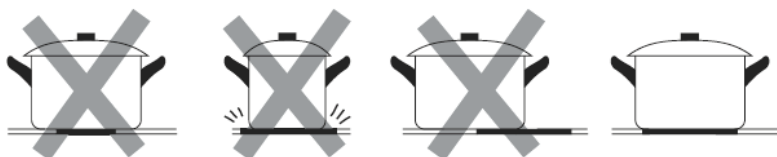

Always lift pans off the ceramic hob – do not slide, or they may scratch the glass.

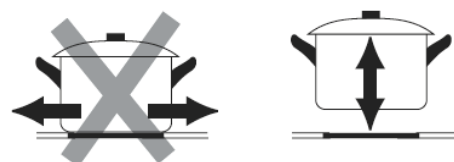

PRODUCT SPECIFICATIONS

Cooking Hob	TCK30
Cooking Zones	2 Zones
Supply Voltage	220-240V~
Installed Electric Power	3000W
Product Size LxWxH (mm)	288 X 520 X 55
Building-in Dimensions AxB (mm)	268 X 500

Weight and Dimensions are approximate. Because we continually strive to improve our products we may change specifications and designs without prior notice.

TROUBLESHOOTING

PROBLEM	POSSIBLE CAUSES	WHAT TO DO
The cooktop cannot be turned on.	No power.	<ul style="list-style-type: none">• Make sure the cooktop is connected to the power supply and that it is switched on.• Check whether there is a power outage in your home or area. If you've checked everything and the problem persists, call a qualified technician.
The glass is being scratched.	Rough-edged cookware. Unsuitable, abrasive scourer or cleaning products being used.	Use cookware with flat and smooth bases. See 'Choosing the right cookware'. See 'Care and cleaning'.

WARRANTY TERMS & CONDITIONS

These Terms and Conditions apply only to Tisira products distributed in Australia and New Zealand by Arisit Pty Limited.

- This warranty applies for a period of 2 years parts and labour, Australia and New Zealand, commencing from date of purchase.
- Evidence of the date of purchase must be shown to the technician, when he calls, to obtain benefit under this warranty.
- This warranty applies only to the original purchaser/hire purchaser of this appliance and cannot be assigned or transferred. Failure to produce documentary proof of the date of original acquisition by the original purchaser will result in a charge being levied for work done, labour and parts supplied.
- This warranty does not apply to:
 - Serviceable items such as filters, fuses, light bulbs, door seals, drive belts, external hoses, etc.
 - Damage to body work, paint work, glass, trivets and plastic items (such as, but not limited to windows, covers, baskets, trays, worktops, door handles, control and kick panels.)
 - Corrosion & rust damage.
 - Damages/blockages caused by laundry or foreign objects.

A fee for service will be charged following warranty claims where no fault is found with the appliance.

- This warranty will not apply where:
 - The fault is caused by accident, misuse, oversuds, an infestation of vermin, fire, flood or the use of products not approved by Arisit Pty. Limited.
 - There has been a failure to comply, with the manufacturer's operating and installation instructions.
 - Service, modification or repair has been carried out by anybody other than an approved Tisira Service Technician.
 - The appliance has been used/installed anywhere other than a private dwelling, or where it has been used other than for domestic use.
 - The appliance is subject to a rental agreement.
- Any defective part that has been replaced becomes the property of Arisit Pty Limited.
- This warranty applies only to Tisira appliances purchased and installed in Australia and New Zealand.
- Loss of use of the appliance or consequential loss of any nature is not covered.
- A charge may be levied at the discretion of Arisit Pty Limited if the call is deemed unnecessary or if the cause of failure is traced to external sources such as, but not limited to: blown fuses, power failure, faulty installation, etc.
- Where the appliance, the subject of a warranty claim or repair, is used or installed more than TWENTY (20) kilometres from the nearest

Arisit Service Division or Authorised Service Agent, the cost of delivery to the nearest Service Division or travel costs for a technician or Authorised Service Agent shall be for the account of the Purchaser. Where a built-in appliance is located or installed outside the Arisit Authorised Service Agent's normal service area, additional travel and labour costs shall be the account of the Purchaser

- Arisit Pty Limited shall not under any circumstances be responsible in terms of this warranty for the replacement or repair of any part of the equipment which may have been damaged in transit, during and after installation or imperfections after installation.
- Losses caused by act of God, failure to obtain spare parts, strikes or lockouts are not covered.
- Service is offered during normal working hours only, also appliances to have clear access in a serviceable area.
- This warranty does not effect your statutory rights.
- Our goods come with guarantees that cannot be excluded under the Australian Consumer Law. You are entitled to a replacement or refund for a major failure and for compensation for any other reasonably foreseeable loss or damage. You are also entitled to have the goods repaired or replaced if the goods fail to be of acceptable quality and the failure does not amount to a major failure.

We reserve the right to amend any of the above without prior notice.

Registration Form

To register for your warranty please complete and return this form to Arisit Pty Limited within 30 days of purchase.



Where did you first hear about Tisira?

- | | |
|---|--|
| <input type="checkbox"/> Advertising | <input type="checkbox"/> Tradesman's Recommendation |
| <input type="checkbox"/> In Store Display | <input type="checkbox"/> Recommendation by Friend/Relative |
| <input type="checkbox"/> Other (please specify) | |

Would you like any further information on other Tisira appliances? Please specify

- | | |
|--------------------------------------|----------------------------------|
| <input type="checkbox"/> Cooking | <input type="checkbox"/> Laundry |
| <input type="checkbox"/> Dishwashers | <input type="checkbox"/> All |

Please print in block letters

Date of Purchase / /

Mr Mrs Ms

Name of Retailer

Initials Surname

Address

Address

Model Number

State..... Postcode.....

Serial Number

Telephone.....

Cut this section and mail to the country of purchase (see overleaf)



CONTACT DETAILS

AUSTRALIA

ARISIT PTY LIMITED

40-44 Mark Anthony Drive,
Dandenong South, VIC 3175,
Australia

P // 1300 762 219

F // 03 9768 0838

consumer.care@arisit.com

NEW ZEALAND

ARISIT PTY LIMITED

PO Box 68-140
Newton, Auckland 1145,
New Zealand

P // 09 306 1020

F // 09 302 0077

sales@aristonappliances.co.nz

TISIRA IS COMMITTED TO ONGOING RESEARCH AND DEVELOPMENT.
EVERY EFFORT HAS BEEN MADE TO ENSURE ALL INFORMATION IN
THIS USER MANUAL IS CORRECT AT TIME OF GOING TO PRINT,
DIMENSIONS SHOULD BE USED AS A REFERENCE ONLY AND ACTUAL
DIMENSIONS SHOULD BE TAKEN FROM THE PHYSICAL PRODUCT ONLY.

MANUFACTURER RESERVES THE RIGHT TO CHANGE SPECIFICATIONS
WITHOUT NOTICE.



tisira

VERSION 1.0



www.tisira.com