

15
Year guarantee

the name you can **trust**



PEX PLUMBING GUIDE





CONTACT US

SALES +44 (0)1934 745160

FAX +44 (0)1934 745161

EMAIL EXPORT@VADO.COM

WEB WWW.PLUMBEX.CO.UK







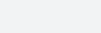

**WORLD
LAND
TRUST™**

www.carbonbalancedpaper.com
CBP006012

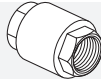
By partnering with the World Land Trust's Carbon Balanced Paper programme, we have offset any emissions produced whilst making this brochure.

CONTENTS

	INTRODUCTION	2		GATE VALVES	25
	ANGLE VALVES	4		CHECK VALVES	27
	SHATAFAS	8		PRESSURE GAUGE	28
	CONCEALED STOP VALVES	9		PRESSURE REDUCING VALVES	29
	BOTTLE TRAPS	10		STOP COCKS / BIBCOCKS	30
	BASIN WASTES	14		BALL FLOATS	32
	BATH WASTES	15		BALL FLOAT VALVES	33
	FLEXIBLE HOSES / BRACKETS	17		SHOWERING ESSENTIALS	35
	BIBTAPS	18		ACCESSORIES	37
	BALL VALVES	21		CONVERSION CHARTS	39

ABOUT PEX

PEX is a worldwide brand of plumbing valves, fittings and accessories. Owned by UK specialist brassware manufacturer VADO, which is part of the Norcross Group PLC.



PEX products are designed with careful attention to detail to ensure longevity of product performance and to guarantee outstanding quality.



As an ISO 9001 accredited company, **PEX** provides customers with a consistently high-standard of product reliability and service, allowing us to offer our industry-leading guarantees*.



PEX works closely with WRc-NSF, one of the leading testing and approval organisations in Europe, to ensure that our products conform to the required high standards.



Industry leading 15 year guarantee*



PEX products are designed and manufactured to the relevant British Standards: BS5154, BS1010, BS5412 and BS1212.



We believe that excellence in design, quality and service does not have to be at the expense of competitive pricing. Please contact your local **PEX** agent or distributor for more details on the **PEX** brand, products or pricing.



PEX has built a renowned reputation on premium product quality and outstanding customer service. Our dedicated customer service team and experienced product experts work in partnership with a network of international sales managers to provide industry-leading product support.



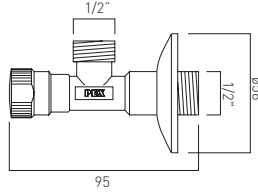

chrome

PEX-225A-C/P

1/2" x 1/2" angle valve

standard packing details

item weight (kg)	0.125
inner box contains box weight (kg)	1 0.148
outer carton contains carton weight (kg)	100 15
full pallet contains pallet weight (kg)	2200 345.0

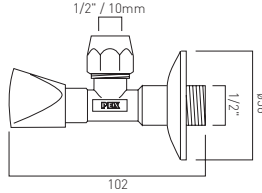

chrome

PEX-226A-C/P

1/2" x 1/2" luxury angle valve
with 10mm compression nut

standard packing details

item weight (kg)	0.232
inner box contains box weight (kg)	1 0.255
outer carton contains carton weight (kg)	100 26.0
full pallet contains pallet weight (kg)	2200 587.0

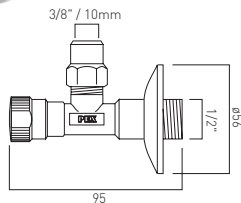

chrome

PEX-228A-C/P

1/2" x 3/8" angle valve with
10mm compression nut

standard packing details

item weight (kg)	0.134
inner box contains box weight (kg)	1 0.158
outer carton contains carton weight (kg)	100 16.0
full pallet contains pallet weight (kg)	2200 367.0

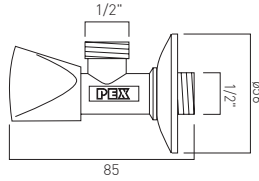

chrome

PEX-229FA-C/P

1/2" x 1/2" angle valve with tricorn handle
(supplied with both hot and cold indices)

standard packing details

item weight (kg)	0.182
inner box contains box weight (kg)	1 0.204
outer carton contains carton weight (kg)	100 20.5
full pallet contains pallet weight (kg)	2400 507.0

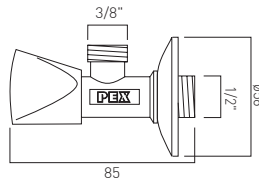

chrome

PEX-236A-C/P

1/2" x 3/8" angle valve with tricorn handle
(supplied with both hot and cold indices)

standard packing details

item weight (kg)	0.182
inner box contains box weight (kg)	1 0.204
outer carton contains carton weight (kg)	100 20.5
full pallet contains pallet weight (kg)	2400 507.0

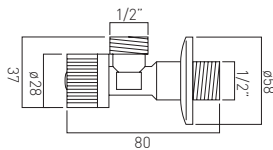

chrome

PEX-233A-C/P

quarter turn angle valve 1/2" x 1/2"
(supplied with both hot and cold indices)

standard packing details

item weight (kg)	0.93
inner box contains box weight (kg)	1 0.113
outer carton contains carton weight (kg)	100 11.5
full pallet contains pallet weight (kg)	2800 337.0

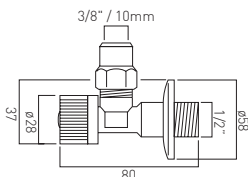

chrome

PEX-234A-C/P

1/2" x 3/8" quarter turn angle valve with 10mm compression nut
(supplied with both hot and cold indices)

standard packing details	
item weight (kg)	0.107
inner box contains box weight (kg)	1 0.126
outer carton contains carton weight (kg)	100 13.0
full pallet contains pallet weight (kg)	2800 379.0

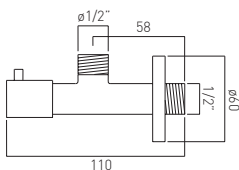

chrome

PEX-230-C/P

1/2" x 1/2" contemporary quarter turn angle valve, includes integrated filter

standard packing details	
item weight (kg)	0.213
inner box contains box weight (kg)	1 0.238
outer carton contains carton weight (kg)	100 24.0
full pallet contains pallet weight (kg)	2000 494.0

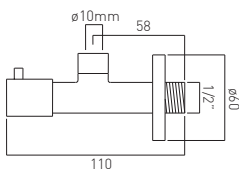

chrome

PEX-221-C/P

1/2" x 3/8" contemporary quarter turn angle valve, 10mm compression nut, includes integrated filter

standard packing details	
item weight (kg)	0.233
inner box contains box weight (kg)	1 0.258
outer carton contains carton weight (kg)	100 26.0
full pallet contains pallet weight (kg)	2000 534.0



AXCES
by VADO

chrome
AX-VIC-160/CD-CP

victoriana 1/2" x 1/2" angle valve

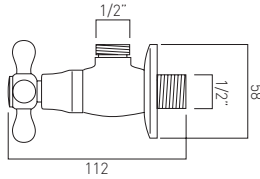

standard packing details

item weight (kg)	0.37
inner box contains box weight (kg)	1 0.41
outer carton contains carton weight (kg)	50 21.0
full pallet contains pallet weight (kg)	900 393.0

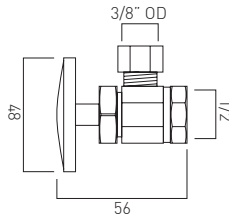

chrome
PEX-231-C/P

american angle valve 1/2" NPT x 3/8" OD

standard packing details

item weight (kg)	0.119
inner box contains box weight (kg)	1 0.128
outer carton contains carton weight (kg)	100 13.2
full pallet contains pallet weight (kg)	4000 543.0

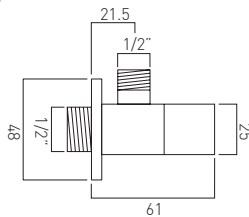

chrome
PEX-232-C/P

square quarter turn angle valve
1/2" x 1/2"

standard packing details

item weight (kg)	0.216
inner box contains box weight (kg)	1 0.229
outer carton contains carton weight (kg)	100 23.0
full pallet contains pallet weight (kg)	4500 1050.0



5
5 year guarantee

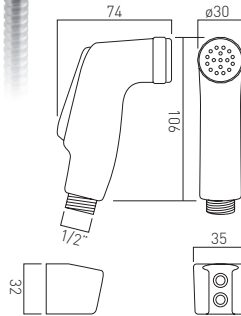

chrome

PEX-SHATTAF

shattaf kit

1.0 bar MP

finishes available:

chrome PEX-SHATTAF-C/P

black / chrome PEX-SHATTAF-B/C

white / chrome PEX-SHATTAF-W/C

standard packing details

item weight (kg)	0.282
inner box contains box weight (kg)	1 0.352
outer carton contains carton weight (kg)	20 15.0
full pallet contains pallet weight (kg)	200 165.0



5
5 year guarantee

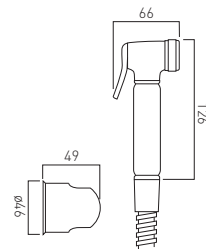

chrome

XSH-LUXSHATTAF100-CP

luxury brass shattaf handset

100cm hose and wall bracket

standard packing details

item weight (kg)	0.57
inner box contains box weight (kg)	1 0.65
outer carton contains carton weight (kg)	20 13.0
full pallet contains pallet weight (kg)	360 249.0

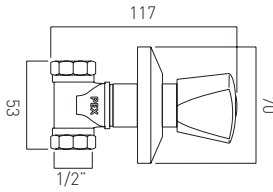
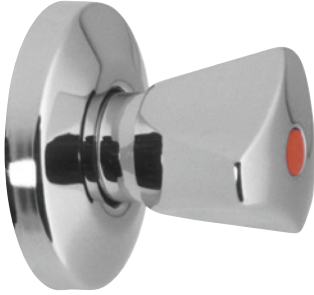

chrome

PEX-760-1/2-C/P

1/2" concealed stop valve
with tricorn handle

(supplied with both hot and cold indices)

standard packing details

item weight (kg)	0.36
inner box contains box weight (kg)	1 0.40
outer carton contains carton weight (kg)	50 21.0
full pallet contains pallet weight (kg)	900 393.0

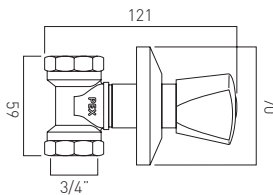
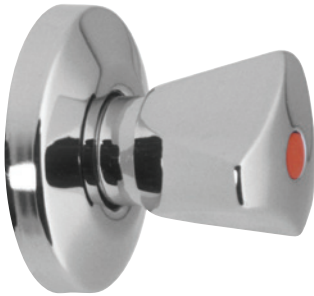

chrome

PEX-760-3/4-C/P

3/4" concealed stop valve
with tricorn handle

(supplied with both hot and cold indices)

standard packing details

item weight (kg)	0.242
inner box contains box weight (kg)	1 0.46
outer carton contains carton weight (kg)	50 23.5
full pallet contains pallet weight (kg)	900 438.0

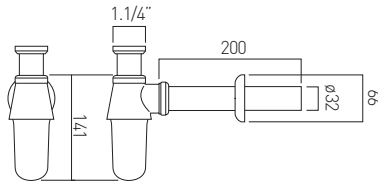

chrome

PEX-460S-1.1/4-C/P

bottle trap

1.1/4" x 1.1/4"

32mm x 200mm outlet pipe

min-max vertical adjustment

50-140mm to outlet centre

standard packing details

item weight (kg)	0.51
inner box contains box weight (kg)	1 0.58
outer carton contains carton weight (kg)	16 9.5
full pallet contains pallet weight (kg)	384 243.0

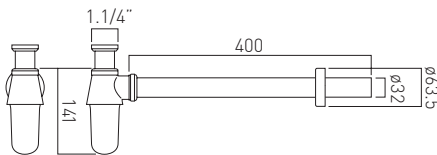

chrome

PEX-460-1.1/4-C/P

bottle trap

1.1/4" x 1.1/4"

32mm x 400mm outlet pipe

min-max vertical adjustment

60-140mm to outlet centre

standard packing details

item weight (kg)	0.64
inner box contains box weight (kg)	1 0.73
outer carton contains carton weight (kg)	8 7.1
full pallet contains pallet weight (kg)	96 100.2

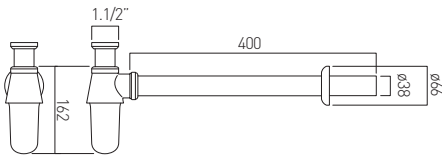

chrome

PEX-460-1.1/2-C/P

1/2" bottle trap

1.1/2" x 1.1/2"

38mm x 400mm outlet pipe

min-max vertical adjustment

50-140mm to outlet centre

standard packing details

item weight (kg)	0.84
inner box contains box weight (kg)	1 0.94
outer carton contains carton weight (kg)	8 7.9
full pallet contains pallet weight (kg)	96 109.8

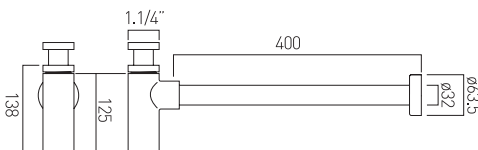

chrome

PEX-461-1.1/4-C/P

contemporary bottle trap

1.1/4" x 1.1/4"

32mm x 400mm outlet pipe

min-max vertical adjustment

60-140mm to outlet centre

standard packing details

item weight (kg)	0.86
inner box contains box weight (kg)	1 1.03
outer carton contains carton weight (kg)	12 13.0
full pallet contains pallet weight (kg)	144 171.0

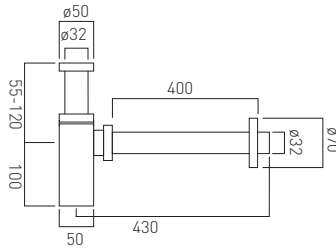
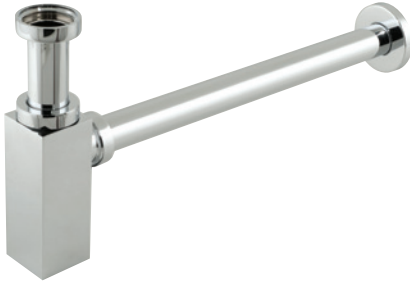

chrome

PEX-461/SQ-1.1/4-C/P

contemporary square bottle trap
1.1/4" x 1.1/4"

32mm x 250mm pipe connections
min-max vertical adjustment
55-120mm to outlet centre

standard packing details

item weight (kg)	0.79
inner box contains box weight (kg)	1 0.96
outer carton contains carton weight (kg)	12 12.0
full pallet contains pallet weight (kg)	144 159.0

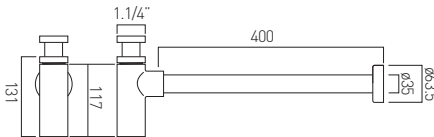

chrome

PEX-461/UK-1.1/4-C/P

contemporary round bottle trap
1.1/4" x 1.1/4"

35mm x 400mm pipe connections
min-max vertical adjustment
60-140mm to outlet centre

standard packing details

item weight (kg)	1
inner box contains box weight (kg)	1 1.1
outer carton contains carton weight (kg)	12 13
full pallet contains pallet weight (kg)	144 181

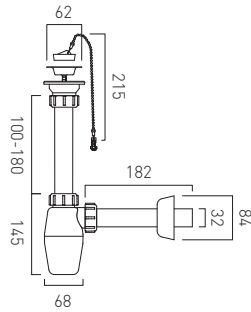

plastic

PEX-471-WHT

1.1/4" white PP bottle trap with plug, chain and waste

standard packing details

item weight (kg)	0.335
inner box contains box weight (kg)	1 0.378
outer carton contains carton weight (kg)	32 13.0
full pallet contains pallet weight (kg)	896 379.0

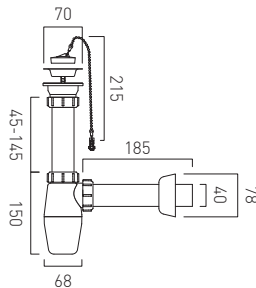

plastic

PEX-472-WHT

1.1/2" white PP bottle trap with plug, chain and waste

standard packing details

item weight (kg)	0.4
outer carton contains carton weight (kg)	36 14.5
full pallet contains pallet weight (kg)	432 174

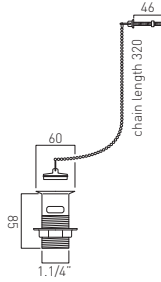

chrome

PEX-KITA-C/P

basin waste kit

1.1/4"

standard packing details

item weight (kg)	0.262
inner box contains box weight (kg)	1 0.298
outer carton contains carton weight (kg)	100 30.3
full pallet contains pallet weight (kg)	1200 378.6

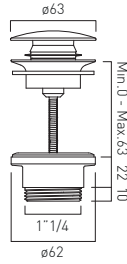

chrome

WG-394-C/P

1.1/4" universal plastic push basin waste

standard packing details

item weight (kg)	0.182
inner box contains box weight (kg)	1 0.021
outer carton contains carton weight (kg)	25 0.55
full pallet contains pallet weight (kg)	1200 280

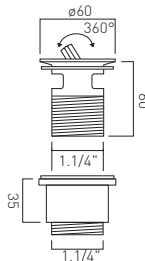

chrome

PEX-392-S-C/P

slotted captive basin waste

with sleeve, 1.1/4"

standard packing details

item weight (kg)	0.37
inner box contains box weight (kg)	1 0.40
outer carton contains carton weight (kg)	60 24.5
full pallet contains pallet weight (kg)	1080 456.0

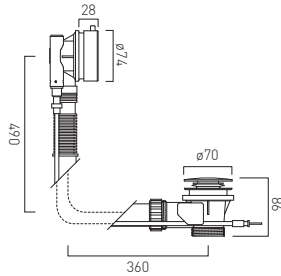

chrome

WG-71552A-CP

bath waste and overflow
with twist operated waste
1.1/2"

standard packing details

item weight (kg)	0.83
inner box contains box weight (kg)	1 1.11
outer carton contains carton weight (kg)	8 11.5
full pallet contains pallet weight (kg)	80 117

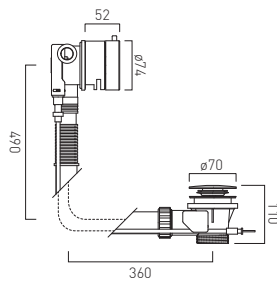

chrome

WG-81552A-CP

bath filler waste overflow
with twist operated waste
1.1/2"

standard packing details

item weight (kg)	1.4
inner box contains box weight (kg)	1 1.67
outer carton contains carton weight (kg)	8 17.5
full pallet contains pallet weight (kg)	80 165

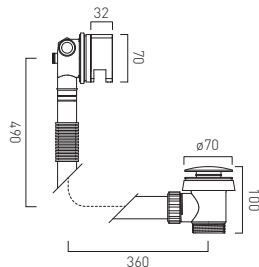

chrome

WG-81389/SQ-C/P

square bath filler waste overflow
with clic-clac operated waste
1.1/2"

standard packing details

item weight (kg)	1.62
inner box contains box weight (kg)	1 1.9
outer carton contains carton weight (kg)	10 18.5
full pallet contains pallet weight (kg)	80 173

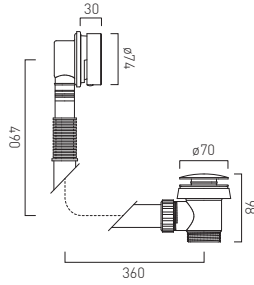

chrome

WG-71389-C/P

bath waste overflow
with clic-clac operated waste
1.1/2"

standard packing details	
item weight (kg)	0.74
inner box contains box weight (kg)	1 1.03
outer carton contains carton weight (kg)	8 10.5
full pallet contains pallet weight (kg)	80 109

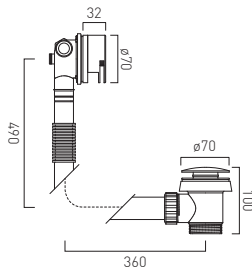

chrome

WG-81389-C/P

bath filler waste overflow
with clic-clac operated waste
1.1/2"

standard packing details	
item weight (kg)	1.58
inner box contains box weight (kg)	1 1.85
outer carton contains carton weight (kg)	8 18.5
full pallet contains pallet weight (kg)	80 173

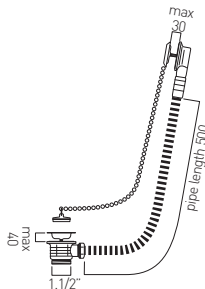

chrome

PEX-KITB-STOW-C/P

stowaway bath waste
with metal plug and chain
1.1/2"

standard packing details	
item weight (kg)	0.23
inner box contains box weight (kg)	1 0.32
outer carton contains carton weight (kg)	20 7.0
full pallet contains pallet weight (kg)	240 99.0



chrome

PEX-222/30-C/P**PEX-222/40-C/P**

braided flexible hose 1/2" x 1/2"

300mm PEX-222/30-C/P

400mm PEX-222/40-C/P

standard packing details

size (mm)	300	400
item weight (kg)	0.096	0.11
inner box contains box weight (kg)	100 10	100 11.91
full pallet contains pallet weight (kg)	2700 285.0	2700 336.3



chrome

WG-049BRACK+SHR-C/P

Pair of shower elbows with shrouds

1/2" x 1/2"

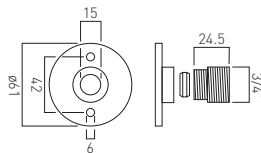
**standard packing details**

item weight (kg)	0.343
inner box contains box weight (kg)	2 0.368
outer carton contains carton weight (kg)	100 38.0
full pallet contains pallet weight (kg)	1600 623.0

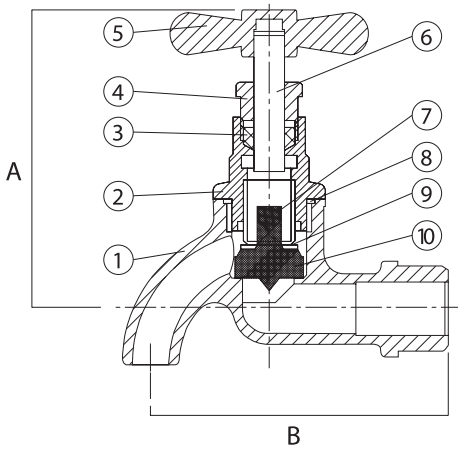

brass

PEX-710-BR-1/2**PEX-710-BR-3/4**brass round nose bibtap,
export patternmaximum pressure conditions:
10 bar - temp up to 90°C**standard packing details**

	size 1/2"	3/4"
item weight (kg)	0.216	0.261
inner box contains box weight (kg)	25 5.5	25 6.5
outer carton contains carton weight (kg)	100 22.0	100 26.5
full pallet contains pallet weight (kg)	3600 807.0	3600 969.0
dimensions A mm	66	73
dimensions B mm	71	79

material specification

key	component	material
1	body	brass
2	bonnet	brass
3	gland packing	PTFE
4	nut	brass
5	handle	brass
6	stem	brass
7	stopper stem	brass
8	o-ring	NBR
9	washer	brass
10	stopper	NBR

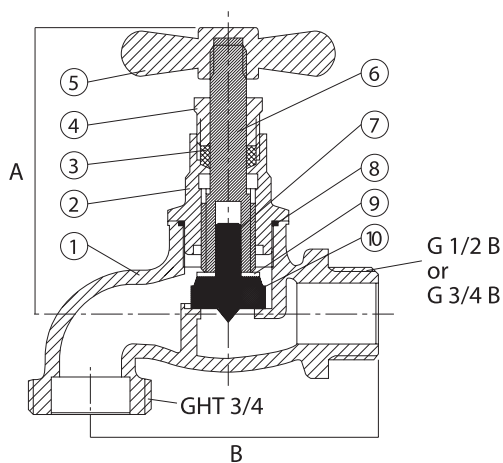

brass

PEX-711N-1/2X3/4**PEX-711N-3/4X3/4**

brass FxF bibtap, BS1010

- manufactured to BS1010 standard
- BS2779 parallel thread

maximum pressure conditions:

16 bar - temp up to 90°C

standard packing details

	size 1/2x3/4"	3/4"
item weight (kg)	0.261	0.288
inner box contains box weight (kg)	25 6.63	20 5.89
outer carton contains carton weight (kg)	100 27.0	80 27.0
full pallet contains pallet weight (kg)	3600 987.0	3600 1230.0
dimensions A mm	63	63
dimensions B mm	70	85

material specification

key	component	material
1	body	brass
2	bonnet	brass
3	gland packing	PTFE
4	nut	brass
5	handle	brass
6	stem	brass
7	stopper stem	brass
8	o-ring	NBR
9	washer	brass
10	stopper	NBR

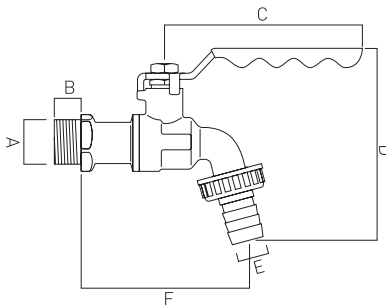

chrome

PEX-708-1/2

PEX-708-3/4

lever arm bibtap

easy grip handle

chrome plated

maximum pressure conditions:

10 bar - temp up to 90°C

standard packing details

	size	1/2"	3/4"
item weight (kg)		0.248	0.320
inner box contains		10	10
box weight (kg)		2.49	3.34
outer carton contains		80	80
carton weight (kg)		21.5	27.5
full pallet contains		2400	2400
pallet weight (kg)		660.0	840.0
dimensions A mm		63	73
dimensions B mm		71	79

dimensions

key	measurement	1/2"	3/4"
A	threaded connection diameter	1/2"	3/4"
B	threaded connection length (mm)	12	13
C	handle length (mm)	92	92
D	handle to spout centre height (mm)	90	95
E	hose fitting inside diameter (mm)	16	20
F	wall mount to spout centre (mm)	78	80

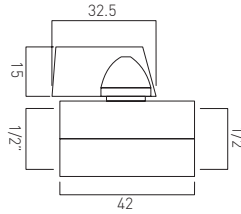

chrome

PEX-601-1/2

FxF mini ball valve

1/2" x 1/2"

standard packing details

item weight (kg)	0.37
inner box contains box weight (kg)	1 0.41
outer carton contains carton weight (kg)	50 21.0
full pallet contains pallet weight (kg)	900 393.0

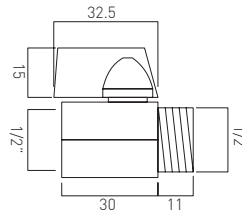

chrome

PEX-601-1/2MX1/2F

FxF mini ball valve

1/2" (male) x 1/2" (female)

standard packing details

item weight (kg)	0.216
inner box contains box weight (kg)	1 0.229
outer carton contains carton weight (kg)	100 23.0
full pallet contains pallet weight (kg)	4500 1050.0

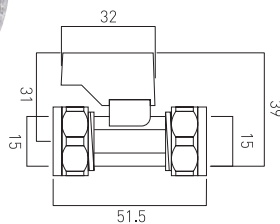

chrome

PEX-602-15MM

compression mini ball valve

15mm

chrome finish

standard packing details

item weight (kg)	0.88
inner box contains box weight (kg)	20 1.81
outer carton contains carton weight (kg)	240 22.0
full pallet contains pallet weight (kg)	8640 807.0

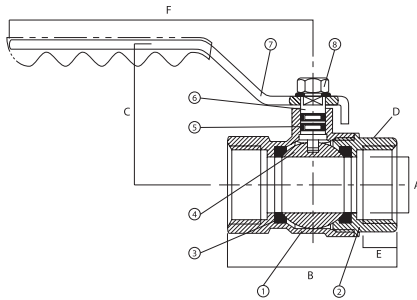
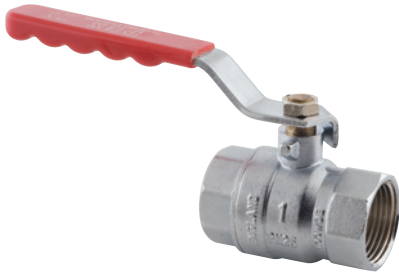

nickel

PEX-600

FxF lever arm ball valve with easy grip handle

- PN 25 rating
- full bore
- quarter turn operation
- high quality PTFE seal
- nickel plated finish

maximum pressure conditions:
25 bar - temp up to 100°C
16.5 bar - temp up to 150°C

suitable for steam, water, oil and air

available sizes as per the 'standard packing details' table

standard packing details						
size	1/2"	3/4"	1"	1.1/4"	1.1/2"	2"
item weight (kg)	0.170	0.261	0.450	0.558	0.878	1.450
inner box contains	20	15	10	6	4	2
box weight (kg)	3.53	4.06	4.64	3.64	3.68	3.11
outer carton contains	120	90	60	36	24	16
carton weight (kg)	21.5	25.0	28.0	22.0	23.0	25.0
full pallet contains	3600	2700	1350	810	552	384
pallet weight (kg)	660.0	765.0	695.0	540.0	544.0	615.0

dimensions						
size	1/2"	3/4"	1"	1.1/4"	1.1/2"	2"
dimension A (mm)	14.5	19	24	30	38	48
dimension B (mm)	52	58	70.5	80.5	90.5	109
dimension C (mm)	44	48	58	80.5	90.5	83
dimension D	1/2"	3/4"	1"	1.1/4"	1.1/2"	2"
dimension E (mm)	10	11	15	16	17	18
dimension F (mm)	87	102	113	132	152	152

material specifications		
key	component	material
1	body	brass
2	end piece	brass
3	seal	PTFE
4	ball	chrome plated brass
5	o-ring	NBR
6	stem	brass
7	handle	steel
8	nut	steel

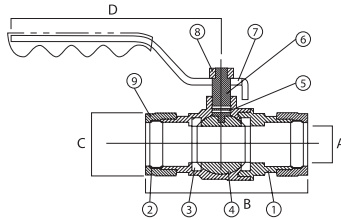

nickel

PEX-609

compression lever arm ball valve with easy grip handle

- PN 16 rating
- compression ends to BS864/2
- full bore
- quarter turn operation
- high quality PTFE seal
- nickel plated finish

maximum pressure conditions:

16 bar - temp up to 30°C

5 bar - temp up to 120°C

available sizes as per the 'standard packing details' table

material specifications

key	component	material
1	body	brass
2	end piece	brass
3	seal	PTFE
4	ball	chrome plated brass
5	o-ring	NBR
6	stem	brass
7	handle	steel
8	nut	steel
9	BS864/2 compression nut	steel

standard packing details

	size	15mm	22mm	28mm
item weight (kg)		0.191	0.323	0.494
inner box contains		20	15	10
box weight (kg)		4.0	4.98	5.12
outer carton contains		80	60	40
carton weight (kg)		20.5	21.5	21.0
full pallet contains		3600	2430	2080
pallet weight (kg)		937.5	853.5	1107.0

dimensions

	size	15mm	22mm	28mm
dimension A (mm)		15	22	28
dimension B (mm)		68	80	93
dimension C (mm)		24	32	38
dimension D (mm)		85	105	113

MADE TO ORDER

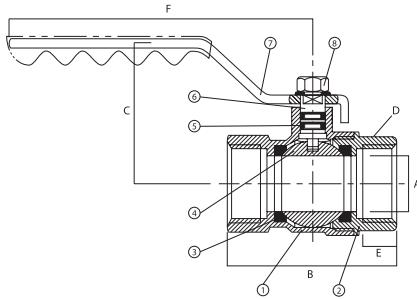

nickel
PEX-600/US

FxF lever arm ball valve
with easy grip handle
unified thread standard

- PN 25 rating
- full bore
- quarter turn operation
- high quality PTFE seal
- nickel plated finish

maximum pressure conditions:
25 bar - temp up to 100°C
16.5 bar - temp up to 150°C

suitable for steam, water, oil and air

available sizes as per the
'standard packing details' table

standard packing details

size	3/4"	1"	1.1/4"	1.1/2"	2"	3"	4"
item weight (kg)	0.261	0.450	0.558	0.878	1.450	3.460	5.760
inner box contains box weight (kg)	15 4.06	10 4.64	6 3.64	4 3.68	2 3.11	1 2.15	1 24
outer carton contains carton weight (kg)	90 25.0	60 28.0	36 22.0	24 23.0	16 25.0	6 21.5	4 24.0
full pallet contains pallet weight (kg)	2700 765.0	1350 695.0	810 540.0	552 544.0	384 615.0	216 789.0	112 687.0

dimensions

size	1/2"	3/4"	1"	1.1/4"	1.1/2"	2"	3"	4"
dimension A (mm)	14.5	19	24	30	38	48	72	90
dimension B (mm)	52	58	70.5	80.5	90.5	109	144.5	171
dimension C (mm)	44	48	58	80.5	90.5	83	123	136
dimension D	1/2"	3/4"	1"	1.1/4"	1.1/2"	2"	3"	4"
dimension E (mm)	10	11	15	16	17	18	21.5	23.5
dimension F (mm)	87	102	113	132	152	152	224	255

material specifications

key	component	material
1	body	brass
2	end piece	brass
3	seal	PTFE
4	ball	chrome plated brass
5	o-ring	NBR
6	stem	brass
7	handle	steel
8	nut	steel

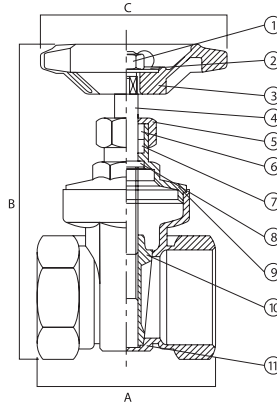
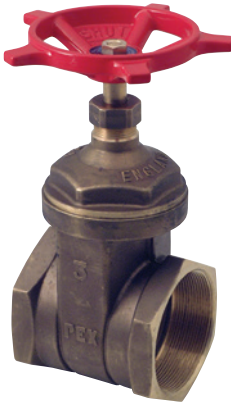

brass

PEX-605BS

brass FxF gate valve, BS5154

- BS5154 PN20
- non rising stem
- solid brass wedge
- high quality PTFE packing
- BS2779 parallel thread (PT)

maximum pressure conditions:
 20.0 bar - temp up to 100°C
 9.0 bar - temp up to 180°C

suitable for: steam, water and oil

available sizes as per the
 'standard packing details' table

material specification

key	component	material
1	handwheel nut	brass
2	rating disc	aluminium
3	handwheel	aluminium alloy
4	stem	brass bar
5	gland nut	forged brass
6	gland packing	PTFE
7	gland	brass bar
8	stem ring	brass bar
9	bonnet	forged brass
10	wedge	forged brass (1/2" - 2") gravity die cast brass (2.1/2" - 6")
11	body	forged brass (1/2" - 2") gravity die cast brass (2.1/2" - 6")

standard packing details and dimensions

size A (mm)	1/2"	3/4"	1"	1.1/4"	1.1/2"	2"	2.1/2"	3"	4"	6"
item weight (kg)	0.214	0.327	0.451	0.786	0.994	1.69	2.9	3.68	6.46	13.8
inner box contains	20	15	10	5	4	3	6	6	2	-
box weight (kg)	4.46	4.99	4.67	4.05	4.11	5.17	18.0	23.5	13.5	-
outer carton contains	80	60	40	20	16	12	6	6	2	2
carton weight (kg)	18.4	20.5	19.2	16.5	16.8	21.1	18.0	23.0	13.5	28.6
full pallet contains	2880	2160	1440	720	576	432	192	192	108	48
pallet weight (kg)	677.4	753.0	706.2	609.0	619.8	774.6	591.0	751.0	744.0	706.4
dimension A mm	47	53	58	76	82	88	97	111	132	154
dimension B mm	86	98	116	139	157	188	232	258	334	447
dimension C mm	61	61	71	85	85	100	150	150	150	170

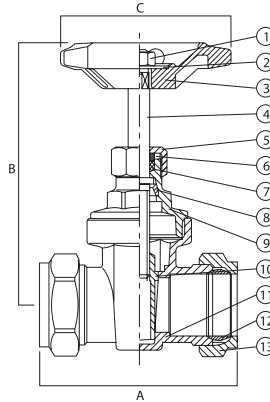
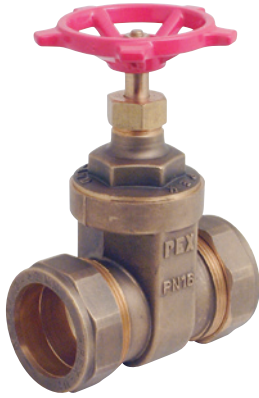

brass

PEX-603BS

brass compression gate valve
BS5154

PEX-603/DZR-35MM

DZR brass compression gate valve
BS5154

available sizes as per the
'standard packing details' table

PEX 603BS standard packing details

size	15mm	22mm	28mm
item weight (kg)	0.235	0.346	0.485
inner box contains	20	15	10
box weight (kg)	4.85	5.31	5.06
outer carton contains	80	60	40
carton weight (kg)	20.0	21.5	20.5
full pallet contains	2160	1620	1080
pallet weight (kg)	555.0	595.5	568.5
dimension A mm	57	67	75
dimension B mm	79	89	104
dimension C mm	61	61	70

PEX-603/DZR standard packing details

size	35mm
item weight (kg)	0.824
inner box contains	1
box weight (kg)	17
outer carton contains	17
carton weight (kg)	20.0
full pallet contains	720
pallet weight (kg)	627.0
dimension A mm	89
dimension B mm	112
dimension C mm	85

PEX 603BS material specifications

key	component	material
1	handwheel nut	brass
2	rating disc	aluminium
3	handwheel	aluminium alloy
4	stem	chrome plated brass
5	gland nut	brass
6	gland	brass
7	gland packing	PTFE
8	stem ring	brass
9	bonnet	brass
10	wedge	brass
11	body	brass
12	compression olive	brass
13	BS874/2 compression nut	brass

PEX-603/DZR material specifications

key	component	material
1	handwheel nut	brass
2	rating disc	aluminium
3	handwheel	aluminium alloy
4	stem	chrome plated brass
5	gland nut	brass
6	gland	brass
7	gland packing	PTFE
8	stem ring	DZR brass-CZ132
9	bonnet	DZR brass-CZ132
10	wedge	DZR brass-CZ132
11	body	DZR brass-CZ132
12	compression olive	DZR brass-CZ132
13	BS874/2 compression nut	DZR brass-CZ132

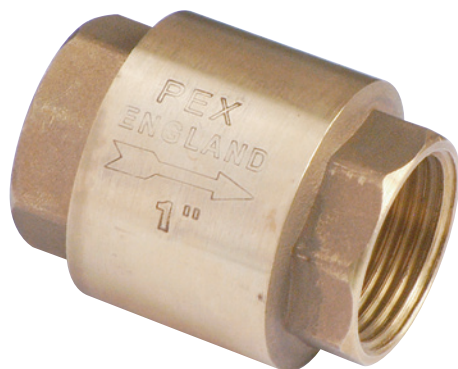

brass

PEX-301B

brass universal spring check valve

maximum pressure conditions:
10 bar - temp up to 90°C

available sizes as per the
standard packing details' table

standard packing details

size	1/2"	3/4"	1"	1.1/4"	1.1/2"	2"
item weight (kg)	0.167	0.214	0.264	0.442	0.561	0.826
inner box contains	20	10	10	5	2	2
box weight (kg)	3.37	2.16	2.68	2.24	1.14	1.68
outer carton contains	200	100	100	50	30	30
carton weight (kg)	35.0	22.5	27.5	23.0	17.5	25.5
full pallet contains	4800	3600	2700	1800	1620	960
pallet weight (kg)	855.0	825.0	757.5	843.0	960.0	831.0

dimensions

size	1/2"	3/4"	1"	1.1/4"	1.1/2"	2"
dimension A	1/2"	3/4"	1"	1.1/4"	1.1/2"	2"
dimension B (mm)	43	49.5	57	67	69	74
dimension C (mm)	38	43	47	60	66	82

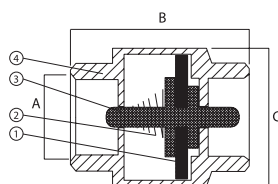
**material specifications**

key	component	material
1	washer	NBR
2	spring	stainless steel
3	spindle	brass
4	body	brass

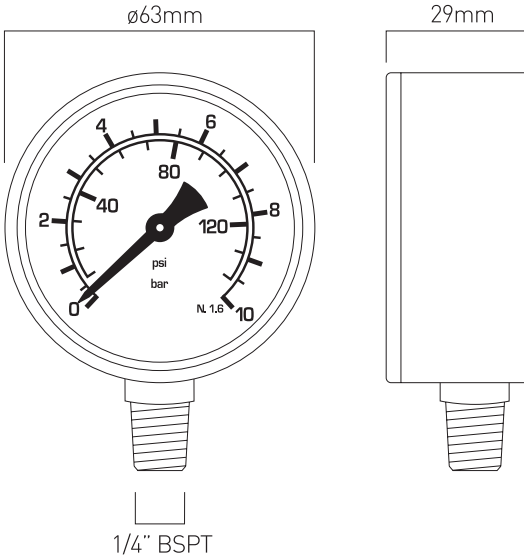

PEX-413-GAUGE

pressure gauge to suit PEX-413

Units of scale: bar - psi

Pressure range: 0-10 bar

Connection: 1/4" Male

Connector position: radial

standard packing details

item weight (kg)	0.092
inner box contains box weight (kg)	1 0.114

discharge and headloss diagram

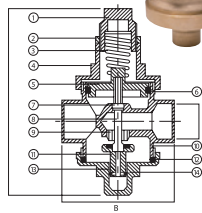
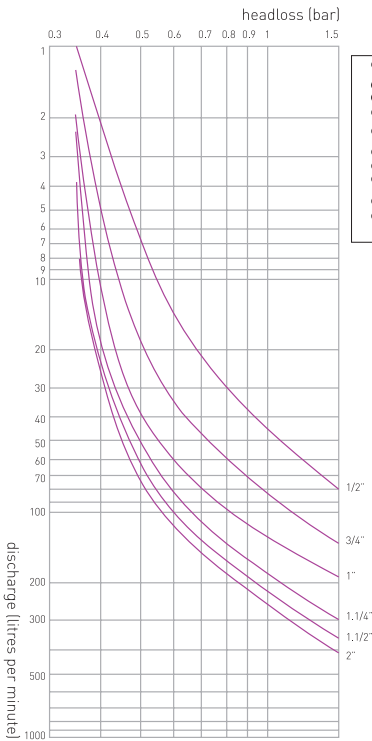

brass

PEX-413

brass pressure reducing valve

maximum/minimum outlet pressure
(all sizes):

maximum: 6 bar - minimum: 0.5 bar

maximum operating temp: 80°C

maximum inlet pressure: 25 bar

material specification

key	component	material	in contact with water
1	spring holder	brass	no
2	fixed ring	brass	no
3	spring	steel	no
4	upper cap	brass	no
5	membrane	brass	yes
6	o-ring	NBR	yes
7	sealing ring with o-ring	brass + NBR	yes
8	bar	brass*	yes
9	seat	stainless steel	yes
10	body	brass	yes
11	shutter	brass	yes
12	gasket	fibre	yes
13	o-ring	NBR	yes
14	lower cap	brass	yes

*stainless steel in sizes higher than 1"

standard packing and dimensions

size	1/2"	3/4"	1"	1.1/4"	1.1/2"	2"	2.1/2"	3"	4"
item weight (kg)	0.722	1.12	1.33	2.28	2.37	3.12	4.05	5.53	6.91
inner box contains	1	1	1	1	1	1	1	1	1
box weight (kg)	0.79	1.19	1.41	2.42	2.51	3.32	4.33	5.76	7.33
outer carton contains	36	32	32	12	12	6	6	3	2
carton weight (kg)	35.6	39.0	46.0	29.3	32.5	20.5	26.5	17.5	15.0
full pallet contains	648	576	576	216	216	108	108	54	36
pallet weight (kg)	655.8	717.0	843.0	542.04	600.36	384.0	492.0	330.0	285.0
dimension A	1/2"	3/4"	1"	1.1/4"	1.1/2"	2"	2.1/2"	3"	4"
dimension B mm	75	85	89	125	130	138	145	177	190
dimension C mm	120	150	160	220	220	250	260	285	310
flow (l/min)	20	34	66	110	160	240	140-180	160-220	200-260
surface in contact with water (cm ²)	69.3	128.3	148.3	295.0	287.3	700.1	855.5	1034	1286
surface / volume	1.53	1.23	1.16	0.94	0.94	0.72	0.91	0.85	0.78

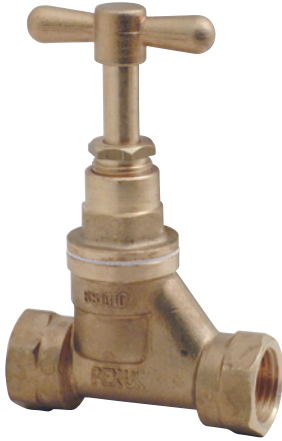

brass

PEX-140S-1/2

PEX-140S-3/4

brass Fx F stop cock, BS1010

- manufactured to BS1010 standard
- BS2779 parallel thread

maximum pressure conditions:
16 bar - temp up to 90°C

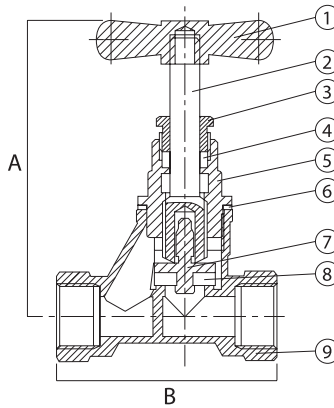

material specification		
key	component	material
1	handle	brass
2	stem	brass
3	gland	brass
4	gland packing	PTFE
5	bonnet	brass
6	gasket	rubber plate
7	stopper stem	brass
8	stopper	NBR
9	body	brass

standard packing and dimensions		
size	1/2"	3/4"
item weight (kg)	0.296	0.601
inner box contains	20	10
box weight (kg)	6.18	6.12
outer carton contains	80	40
carton weight (kg)	25.0	25.0
full pallet contains	2880	1440
pallet weight (kg)	915.0	915.0
dimension A mm	96	109
dimension B mm	69	98

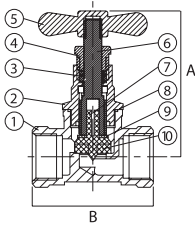

brass

PEX-149-1/2**PEX-149-3/4**

brass export pattern stop cock

maximum pressure conditions:

16 bar - temp up to 90°C

material specification		
key	component	material
1	body	brass
2	bonnet	brass
3	gland packing	PTFE
4	nut	brass
5	handle	brass
6	stem	brass
7	stopper stem	brass
8	o-ring	NBR
9	washer	brass
10	stopper	NBR

standard packing and dimensions			
	size	1/2"	3/4"
item weight (kg)		0.21	0.26
inner box contains		25	25
box weight (kg)		5.27	6.66
outer carton contains		100	100
carton weight (kg)		21.5	27.5
full pallet contains		3600	3600
pallet weight (kg)		789.0	1005.0
dimension A mm		65	65
dimension B mm		53	59

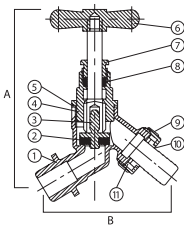
**PEX-151-BR-1/2****PEX-151-BR-3/4**brass heavy duty hose union bibcock,
BS1010

maximum pressure conditions:

10 bar - temp up to 90°C

material specification		
key	component	material
1	body	brass
2	stopper	NBR
3	stopper stem	brass
4	bonnet	brass
5	gasket	rubber plate
6	handle	brass
7	gland	brass
8	gland packing	PTFE
9	nut	brass
10	hose union	brass
11	o-ring	NBR

standard packing and dimensions			
	size	1/2"	3/4"
item weight (kg)		0.308	0.572
inner box contains		20	10
box weight (kg)		6.31	6.1
outer carton contains		80	40
carton weight (kg)		25.5	24.0
full pallet contains		2880	1440
pallet weight (kg)		933.0	879.0
dimension A mm		106	124
dimension B mm		78	108



plastic

PEX-816

orange ball float

- PP float
- nipple with brass threaded insert

don't forget to order a float valve – see page 33

available sizes as per the 'standard packing details' table

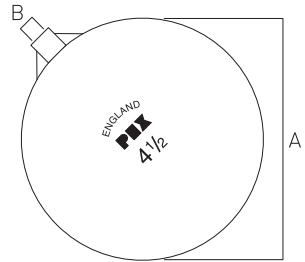

standard packing details					
size	4.1/2"	5"	6"	8"	10"
item weight (kg)	0.09	0.109	0.16	0.41	0.762
outer bag contains	100	50	50	50	10
bag weight (kg)	9.0	5.5	8.0	20.5	7.6

dimensions					
size (inches)	4.1/2"	5"	6"	8"	10"
diameter A (inches)	4.1/2"	5"	6"	8"	10"
connection B (inches)	5/16"	5/16"	7/16"	7/16"	7/16"

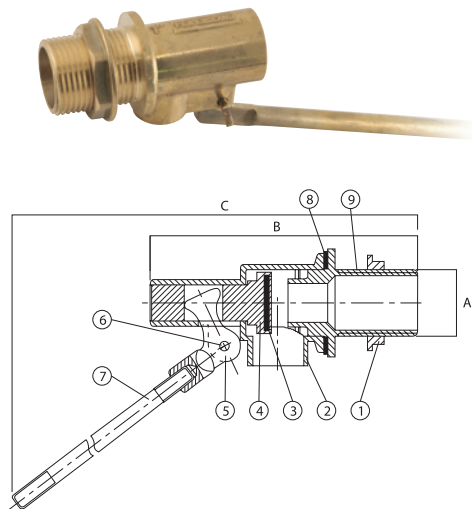

brass

PEX-806

brass MOH float valve

- solid brass one piece construction
- brass back nut
- brass piston

maximum pressure conditions:
14 bar - temp up to 160°C

available sizes as per the
'standard packing details' table

**don't forget to order a ball float -
see page 32**

recommended float sizes		
valve size	ball size	item code (ball float)
1/2"	4.1/2"	PEX-816-4.1/2
3/4"	5"	PEX-816-5
1"	6"	PEX-816-6
1.1/4"	8"	PEX-816-8
1.1/2"	10"	PEX-816-10
2"	10"	PEX-816-10

material specification		
key	component	material
1	flange nut	brass
2	body	brass
3	washer	EDPM
4	piston	brass
5	arm sleeve	brass
6	pin	brass
7	arm	brass
8	washer *	fibre
9	tail	brass
* on sizes larger than 1"		

standard packing details						
size	1/2"	3/4"	1"	1.1/4"	1.1/2"	2"
item weight (kg)	0.264	0.304	0.629	1.43	1.52	1.62
inner box contains	75	50	20	16	16	16
box weight (kg)	20.5	15.5	13.0	24.0	25.0	26.0
full pallet contains	3375	2250	1080	384	384	384
pallet weight (kg)	937.5	712.5	712.0	591.0	615.0	639.0
dimension A	1/2"	3/4"	1"	1.1/4"	1.1/2"	2"
dimension B mm	78	79	92	167	167	170
dimension C mm	255	305	360	470	515	515
flow rate at 1bar (m ³ /hr)	0.47	0.73	1.63	3.9	4.2	4.6
hole in seat diameter mm	6.0	7.5	11.5	25	25	25

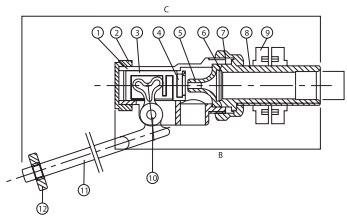

brass

PEX-807-1/2

PEX-807-3/4

float valve

with brass piston and brass backnut

BS1212 (pt.1)

1/2" or 3/4"

don't forget to order a ball float – see page 32

material specification

key	component	material
1	body	brass
2	end nut	brass
3	piston	brass
4	washer	EDPM
5	seat	POM (plastic)
6	washer	fibre
7	joint nut	brass
8	tail	brass
9	nut	brass
10	pin	brass
11	arm	brass
12	arm nut	brass

standard packing and dimensions

	size	1/2"	3/4"
item weight (kg)		0.312	0.64
outer carton contains		50	30
carton weight (kg)		16.0	20.0
full pallet contains		2250	1020
pallet weight (kg)		735.0	695.0
dimension A		1/2"	3/4"
dimension B mm		107	128
dimension C mm		290	388

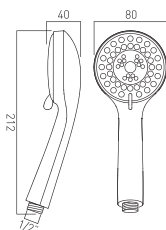

VADO

chrome

ERI-HANDESET/MF-DB-CP

Eris

3 function handset

rub-clean

standard packing details

item weight (kg)	0.14
inner box contains box weight (kg)	1 0.23
outer carton contains carton weight (kg)	30 7.9
full pallet contains pallet weight (kg)	450 133

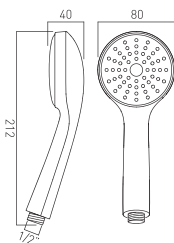

VADO

chrome

ERI-HANDESET/SF-DB-CP

Eris

single function handset

rub-clean

standard packing details

item weight (kg)	0.12
inner box contains box weight (kg)	1 0.21
outer carton contains carton weight (kg)	30 7.3
full pallet contains pallet weight (kg)	450 125

 adjustable fixing
for easy retro fit



10
year guarantee

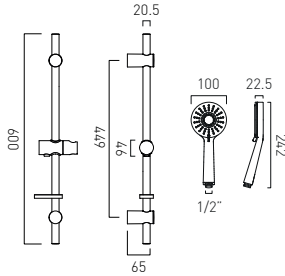

AXCES
by VADO

chrome

AX-SIR-MFSRK-DB-CP

slide rail shower kit
with 3 function sirkel handset
600mm slide rail

standard packing details

item weight (kg)	0.78
inner box contains box weight (kg)	1 1.41
outer carton contains carton weight (kg)	8 12.5
full pallet contains pallet weight (kg)	48 94.96

 adjustable fixing
for easy retro fit



10
year guarantee

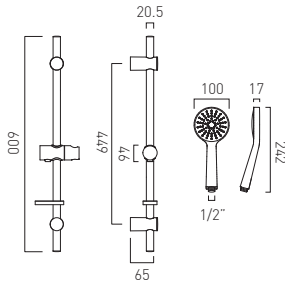

AXCES
by VADO

chrome

AX-SIR-SFSRK-DB-CP

slide rail shower kit
with single function sirkel handset
600mm slide rail

standard packing details

item weight (kg)	0.74
inner box contains box weight (kg)	1 1.37
outer carton contains carton weight (kg)	8 12.23
full pallet contains pallet weight (kg)	48 93.35

10
year guarantee



AXCES
by VADO

chrome

AX-SH-015-150-DB-CP

chrome plated stainless steel
standard bore 150cm shower hose
1/2" x 1/2" conical connection

standard packing details

item weight (kg)	0.22
inner box contains box weight (kg)	1 0.3
outer carton contains carton weight (kg)	20 6.91
full pallet contains pallet weight (kg)	360 144.24

AXCES
by VADO



10
year guarantee

chrome

AX-SIR-189-CP

Sirkel

5 accessory pack:

paper holder

towel ring

robe hook

frosted glass tumbler and holder

frosted glass soap dish and holder

standard packing details

item weight (kg)	1
inner box contains box weight (kg)	- -
outer carton contains carton weight (kg)	5 7.5
full pallet contains pallet weight (kg)	45 51.5

AXCES
by VADO



10
year guarantee

chrome

AX-SIR-189A-CP

Sirkel

6 accessory pack:

closed paper holder

towel ring

robe hook

frosted glass tumbler and holder

frosted glass soap dish and holder

towel rail 600mm (24")

standard packing details

item weight (kg)	1.15
inner box contains box weight (kg)	- -
outer carton contains carton weight (kg)	5 7.5
full pallet contains pallet weight (kg)	30 51.5

AXCES
by VADO



chrome

AX-BOK-189-CP

Box:

5 accessory pack:

paper holder

towel ring

robe hook

frosted glass tumbler and holder

frosted glass soap dish and holder

standard packing details

item weight (kg)	1
inner box contains box weight (kg)	- -
outer carton contains carton weight (kg)	5 7.5
full pallet contains pallet weight (kg)	45 51.5

AXCES
by VADO



chrome

AX-BOK-189A-CP

Box:

6 accessory pack:

closed paper holder

towel ring

robe hook

frosted glass tumbler and holder

frosted glass soap dish and holder

towel rail 600mm (24")

standard packing details

item weight (kg)	1.15
inner box contains box weight (kg)	- -
outer carton contains carton weight (kg)	5 7.5
full pallet contains pallet weight (kg)	30 51.5

metric conversion factors: pressure and stress

multiply

atmosphere (14.6959 lb/inch²)

bar

bar

bar

hectobar

kilogram/centimetre²kilogram/metre²kilogram/metre²kilogram/metre²kilonewton/metre²newton/centimetre²newton/metre²newton/metre²newton/metre²newton/metre²newton/millimetre²

pascal

pascal

pascal

pascal

pascal

pascal

pound/foot²pound/foot²pound/inch²pound/inch²newton/centimetre²pound/inch²pound/inch²pound/inch²pound/inch²ton (long)/inch²

by

101,325.

100,000. *

14.50377

100,000. *

0.6474898

14.22334

9.806650 *

9.806650 *

0.2048161

0.1450377

1.450377

0.00001 *

1.0

0.0001450377

0.1019716

145.0377

0.0000986923

0.00001 *

0.1019716

1.0 *

0.02088543

0.0001450377

4.882429

47.88026

0.06894757

0.07030697

0.6894757

6.894757

6,894.757

0.006894757

6,894.757

1.544426

to obtain

pascal (Pa)

pascal (Pa)

pound/inch²newton/metre² (N/m²)ton (long)/inch²pound/inch²newton/metre² (N/m²)

pascal (Pa)

pound/foot²pound/inch²pound/inch²

bar

pascal (Pa)

pound/inch²kilogram/metre²pound/inch²

atmosphere

bar

kilogram/metre²newton/metre² (N/m²)pound/foot²pound/inch²kilogram/metre²

pascal (Pa)

bar

kilogram/centimetre²newton/centimetre²kilonewton/metre²newton/metre² (N/m²)newton/millimetre² (N/mm²)

pascal (Pa)

hectobar

metric conversion factors: mass and density

multiply

atmosphere (14.6959 lb/inch²)

bar

bar

bar

hectobar

kilogram/centimetre²kilogram/metre²kilogram/metre²kilogram/metre²kilonewton/metre²newton/centimetre²newton/metre²newton/metre²newton/metre²newton/metre²newton/millimetre²

pascal

pascal

pascal

pascal

pascal

pascal

pound/foot²pound/foot²pound/inch²pound/inch²newton/centimetre²pound/inch²pound/inch²pound/inch²pound/inch²ton (long)/inch²

by

101,325.

100,000. *

14.50377

100,000. *

0.6474898

14.22334

9.806650 *

9.806650 *

0.2048161

0.1450377

1.450377

0.00001 *

1.0

0.0001450377

0.1019716

145.0377

0.0000986923

0.00001 *

0.1019716

1.0 *

0.02088543

0.0001450377

4.882429

47.88026

0.06894757

0.07030697

0.6894757

6.894757

6,894.757

0.006894757

6,894.757

1.544426

to obtain

pascal (Pa)

pascal (Pa)

pound/inch²newton/metre² (N/m²)ton (long)/inch²pound/inch²newton/metre² (N/m²)

pascal (Pa)

pound/foot²pound/inch²pound/inch²

bar

pascal (Pa)

pound/inch²kilogram/metre²pound/inch²

atmosphere

bar

kilogram/metre²newton/metre² (N/m²)pound/foot²pound/inch²kilogram/metre²

pascal (Pa)

bar

kilogram/centimetre²newton/centimetre²kilonewton/metre²newton/metre² (N/m²)newton/millimetre² (N/mm²)

pascal (Pa)

hectobar

metric conversion factors: length

multiply	by	to obtain
centimetre	0.0328084	foot
centimetre	0.3937008	inch
fathom	1.8288 *	metre (m)
foot	0.3048 *	metre (m)
foot	30.48 *	centimetre (cm)
foot	304.8 *	millimetre (mm)
inch	0.0254 *	metre (m)
inch	2.54 *	centimetre (cm)
inch	25.4 *	millimetre (mm)
kilometre	0.6213712	mile (US statute)
metre	39.37008	inch
metre	0.54680066	fathom
metre	3.280840	foot
metre	0.1988388	rod
metre	1.093613	yard
metre	0.0006213712	mile (US statute)
microinch	0.0254 *	micrometre (micron) (um)
micrometre (micron)	39.37008	microinch
mile (US statute)	1,609.344 *	metre (m)
mile (US statute)	1.609344 *	kilometre (km)
millimetre	0.003280840	foot
millimetre	0.0397008	inch
rod	5.0292 *	metre (m)
yard	0.9144 *	metre (m)

metric conversion factors: temperature

to convert from	to	use this formula
temperature Celsius, t C	temperature Kelvin, t K	$t K = t C + 273.15$
temperature Fahrenheit, t F	temperature Kelvin, t K	$t K = (t F + 459.67) / 1.8$
temperature Celsius, t C	temperature Fahrenheit, t F	$t F = 1.8t C + 32$
temperature Fahrenheit, t F	temperature Celsius, t C	$t C = (t F - 32) / 1.8$
temperature Kelvin, t K	temperature Celsius, t C	$t C = t K - 273.15$
temperature Kelvin, t K	temperature Fahrenheit, t F	$t F = 1.8t K - 459.67$
temperature Kelvin, t K	temperature Rankine, t R	$t R = 9/5t K$
temperature Rankine, t R	temperature Kelvin, t K	$t K = 5/9t R$

note: symbols of SI units, multiples and submultiples are given in parentheses in the right hand column



www.plumbex.co.uk

the name you can **trust**



VADO

Wedmore Road Cheddar Somerset England BS27 3EB

tel +44 (0)1934 745160

fax +44 (0)1934 745161

www.plumbex.co.uk

export@vado.com

due to our policy of continual improvement, VADO reserve the right to change product specification. the colours indicated are an approximation of the actual finishes on VADO products. e&oe.

©2021 LIT-PEXCATALOGUE-21

