



---

# Fixing Guide

---

January 2022

# – Contents –

	PAGE
<b>Product Information</b> .....	<b>3</b>
No Special Tools Required .....	3
Storing the Product .....	3
Product Description .....	3
TapcoSlate Information .....	4
Pitch, Gauge, and Coverage .....	4
Recycling .....	4
Fastener Recommendations .....	4
Roof Decking Materials .....	5
Roofing Membrane/Underlay .....	5
<b>Installation Guidelines</b> .....	<b>6</b>
Spacing Between the Slates .....	6
Laying Out ½ Slates or Cut Slates .....	6
Preparation .....	6
Hip Roof Layout .....	6
Fully Boarded Roof .....	8
Felt and Batten Roof .....	9
Fixing TapcoSlate Ridge/Hip Caps .....	12
Ridge/Hip Cap Finishing .....	13
Angled Ridge-to-Hip Junction .....	13
Ridge 90° End Cap .....	14
Alternate Ridge/Hip Cap Finishing .....	14
Standard Ridge Cap End Piece .....	14
Angled Ridge Cap End Piece .....	15
5-way Ridge to Hip Joint .....	15
Weatherproofing the Ridge-to-Hip Intersection .....	16
Valleys .....	16
Closed Valley Design .....	16
Open Valley Design .....	17
Flashings .....	17
Apron (Roof to Wall) Flashing .....	17
Step Flashings .....	18
Counter Flashing .....	18
Vent Flashings .....	19
Soil Stack .....	19
Pitch changes .....	19
Chimney Saddles .....	19
Hip & Ridge Detail .....	20
<b>Warm &amp; Cold Roof Structures</b> .....	<b>22</b>
Warm Roof Installation .....	22
Cold Roof Installation .....	25
<b>Ventilation</b> .....	<b>28</b>
British Standard (BS) 5250 .....	28
Guidelines for Low-level Roof Ventilation .....	29
Guidelines for High-level Roof Ventilation .....	30
<b>Special Instructions</b> .....	<b>22</b>
Installation in Exceptionally High Wind Areas .....	22
Turret Installation .....	23
Removing/Re-fitting TapcoSlates .....	24
TapcoSlate Accessories .....	26

**Please note that the following Accessory fixing guides are also available on our website as downloads:**

- |                                   |                       |                          |
|-----------------------------------|-----------------------|--------------------------|
| • TapcoSlate Care and Maintenance | • Inline Slate Vent   | • Eaves Ventilation Kits |
| • RidgeMaster Plus & HipMaster    | • Cowl Vent           | • Rafter Roll Ventilator |
| • Dry Verge                       | • Abutment Ventilator |                          |

Visit: [www.TapcoRoofingProducts.com/product-guides](http://www.TapcoRoofingProducts.com/product-guides)

## – Product Information –

### No Special Tools Required

- Hand fastened (hammered or screwed) or fastened with a nail/screw gun.
- Sharp utility blade or a standard circular saw.
- Tape measure, pry bar, tin snips.
- Chalk line with blue chalk (do not use red chalk as this can stain the product).



### Storing the Product

For proper installation, the slates need to be stored on the original pallet on a flat surface. Proper storage of the product at the job site is important. Classic slates are cambered to ensure that maximum pressure is transferred to the leading edge of the slate during installation and should be stacked face down (as originally delivered). **Do not double stack pallets.**

**Conditions:** Perform work when existing and forecasted weather permits. Work should be performed in a safe and professional manner and when ambient weather conditions are within the limits established by Tapco Roofing Products.

**Storage:** TapcoSlates should not be stored on roof decks in such a manner as to over-stress and/or damage the deck and supporting structure.

**Cold Weather Installation:** TapcoSlates should be stored in original packaging in a storage facility where the temperature meets or exceeds 7°C. Use protective coverage over all pallets while being temporarily stored on-site. TapcoSlates must be conditioned at a temperature no lower than 7°C for twenty-four (24) hours prior to use. TapcoSlates may be installed at temperatures as low as 0°C but must be hand fastened, the use of a pneumatic gun below 7°C will result in cracking and webbing in the fastened area. Be sure to follow the manufacturer’s installation requirements for all underlay or membrane and any other applications. Comply with any and all local building regulations. **Note of Caution:** The slates can be slippery under certain conditions and job site safety procedures should be enforced.

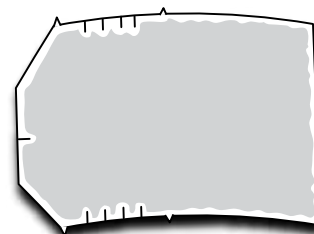

### Product Description

TapcoSlates are manufactured from a blend of limestone and virgin polypropylene, and are made from multiple natural patterns. TapcoSlate is not made from recycled materials but can be recycled at the end of its long lifespan.

<b>WARRANTY:</b>	40 Years	<b>ROOFING BOARD:</b>	0.7" (18mm) OSB.
<b>WEIGHT (CLASSIC SLATE):</b>	0.7 kg	<b>MINIMUM PITCH:</b>	14° (Felt & Batten and Fully Boarded).
<b>WEIGHT (CLASSIC RIDGE):</b>	0.7 kg	<b>MAXIMUM PITCH:</b>	90° (Felt & Batten and Fully Boarded).
<b>DRILLING:</b>	No drilling required	<b>SORTING:</b>	No sorting required.
<b>PACKAGING (CLASSIC 12"):</b>	Pallet: 1600 slates (1.04 tonnes), Bundle: 25 slates (16.25 kg).	<b>BATTEN SIZE:</b>	2" x 1" (50mm x 25mm) treated battens (minimum).
<b>ROOFING MEMBRANE:</b>	Recommended use of impermeable (non-breathable) Type HR roofing membrane.	<b>CUTTING:</b>	Fine-toothed handsaw, jigsaw, circular saw, or sharp utility blade (score and break).
<b>FIXING:</b>	Large 10mm diameter head, galvanised 1.2" (30mm) by 0.1" (2.5mm) steel nails or 1.2" (30mm) by 0.14" (3.5mm) outdoor Phillips bugle screws (using hammer/screwdriver or nail/screw-gun). Longer 2" (50mm) nail or outdoor Phillips bugle screw required for fixing ridges and hips. Corrosion resistant fasteners are always recommended, especially in coastal areas. In Scotland we recommend the use of Stainless Steel nails for fixing. 7.1mm diameter nail heads are recommended when using a nail gun.		

**Please note:** the diagrams in this guide are for illustration purposes only, actual sizes/placement may vary from those shown. If in doubt, please contact your local area manager for advice, or contact our technical department: +44 (0)1482 880478.

**IMPORTANT:** Advice from our technical department should be sought when installing on high buildings and/or in exceptionally windy areas. Telephone: +44 (0)1482 880478.

**TapcoSlate Information (all measurements are approximate)**

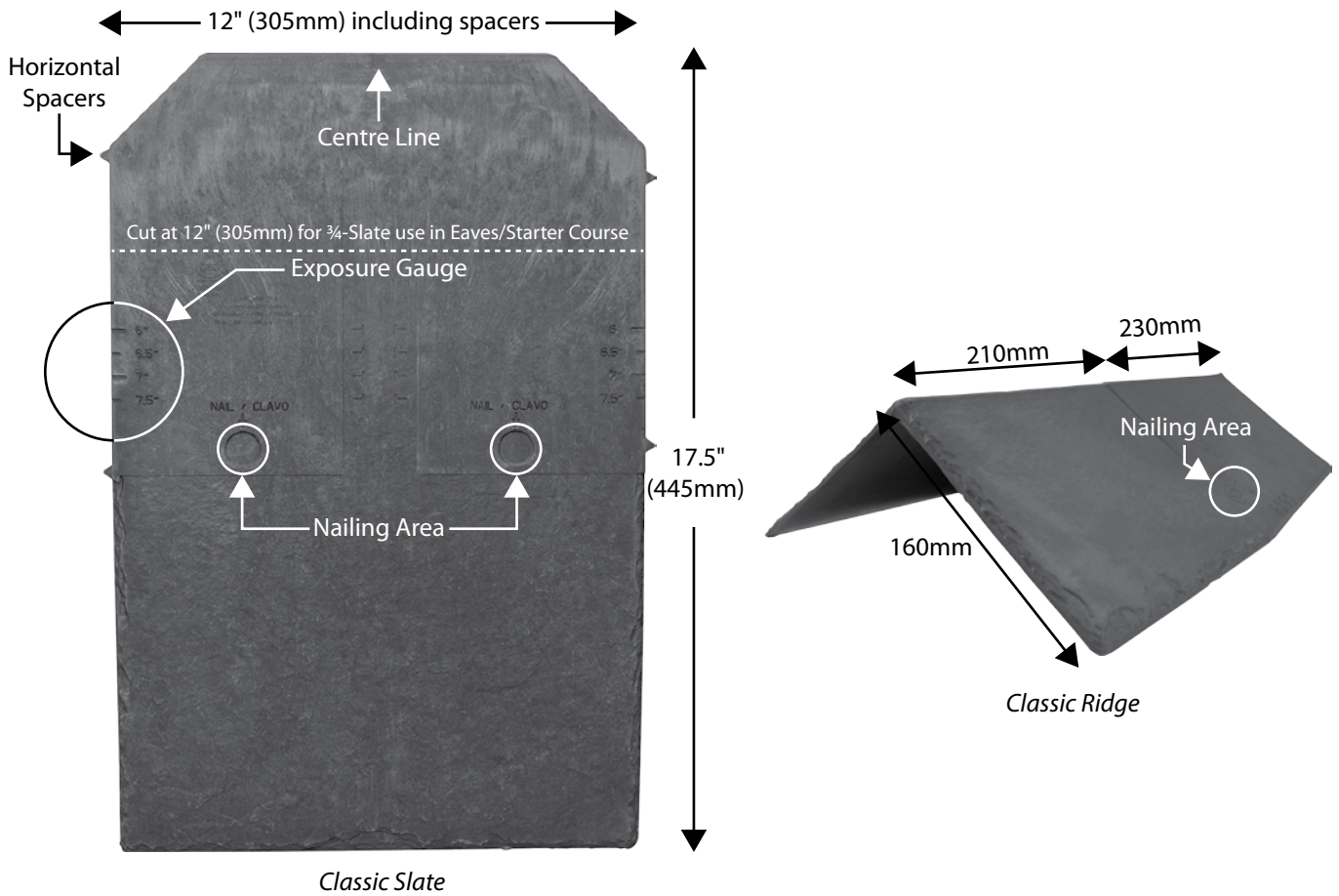

**Pitch, Gauge, and Coverage**

**TapcoSlate Classic**

ROOF PITCH	GAUGE	SLATES PER M <sup>2</sup>	RIDGE & HIP CAPS	1 METRE LENGTH
14* to 25 degrees (fully boarded or felt & battens)	6" (152mm)	22	Ridge Cap	6 Units
25 to 27.5 degrees (fully boarded or felt & battens)	6.5" (165mm)	20	Hip Cap	6 Units
27.5 to 30 degrees (fully boarded or felt & battens)	7" (178mm)	19		
above 30 degrees (fully boarded or felt & battens)	7.5" (191mm)	18		

\* The minimum recommended pitch and lap may be influenced by special circumstances, please contact our technical department for advice.

**Recycling**

TapcoSlate is 100% recyclable, but is not marked with a recycling symbol/logo and so the contractor should contact a local recycler to make the necessary arrangements, stating that the product is "mineral-filled Polypropylene" plastic. If there is any difficulty in locating a recycling facility, please contact us. Note that skip companies will send the product to the correct recycler.

**Fastener Recommendations**

Slates should be applied using two (2) large 10mm diameter head, galvanised 1.2" (30mm) by 0.1" (2.5mm) steel nails or 1.2" (30mm) by 0.14" (3.5mm) outdoor Phillips bugle screws (using hammer/screwdriver or nail/screw-gun). Corrosion resistant fasteners are always recommended, especially in coastal areas. In Scotland we recommend the use of Stainless Steel nails for fixing. 7.1mm diameter nail heads are recommended when using a nail gun. All slates will be attached with two fasteners, as per these instructions.

The length of the Hip & Ridge fastener should be a minimum length of 2" (50mm) over the slates and 3" (75mm) over ridge vent.

**Note:** Caution should always be used to ensure against over/under penetration of the fastener. **Do not over-drive the fastener.** The fastener head should be contacting the slate within the centre of the nailing target circle.

*Improper fastening can compromise the roof system and voids the manufacturers' warranty.*

## Roof Decking Materials

- Minimum of 23/32" (18mm) plywood decking, solid wood decking, or oriented strand board (OSB).

## Roofing Membrane/Underlay

TapcoSlate Classic roofing slates are classed as **insufficiently air-open** products and therefore, following the guidance within BS 5250, a **vapour impermeable (HR)** roof membrane/underlay should be used. Tapco Roofing Products recommends *Protect Wunderlay* for TapcoSlate Classic and offers the following guidance:

### Air Permeability

The detail below explains how a vapour permeable (LR) roofing membrane allows water vapour to escape the structure and requirements for ventilation of the counter batten space when using a roof covering that is insufficiently air-open.

### Roof coverings and batten space ventilation using vapour permeable underlays (type LR)

Where vapour permeable underlays (type LR) are used in both cold and warm roofs to contribute to the control of condensation, they do so by allowing water vapour to escape through the material by diffusion. It is important that this water vapour can escape through the roof covering to atmosphere from the tiling batten space. BS 5250 defines the level of air openness required of the roof covering and the test method. Traditional concrete and clay tiles should be sufficiently air open, but advice should be sought from the roof covering manufacturer/supplier.

### Roof covering insufficiently air-open

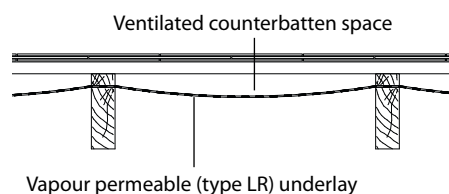

For roof coverings that do not meet the required air openness, provide a counterbatten space at least 25mm deep, with ventilation of 25 000mm<sup>2</sup>/m at eaves or low level and 5000mm<sup>2</sup>/m at ridge or high level. This is in addition to the ventilation already specified for cold and warm roofs.

### Roof covering sufficiently air-open

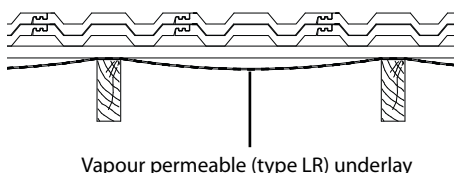

**With impermeable underlays (type HR) this ventilation is unnecessary as there will be relatively little moisture transfer from within the building to the batten space.**

## Cold Roof Applications

When installing TapcoSlate Classic onto either battens or OSB a **vapour impermeable (type HR)** roof membrane/underlay should be used. When installing directly onto OSB, ventilation in accordance with BS 5250 to the loft void should be adhered to. Insulation should be installed on the horizontal ceiling below. To further enhance this construction, improving thermal performance of all insulation by reducing convection flow and help to avoid interstitial condensation risk within insulation in accordance with BS 5250, we would recommend installing an air barrier on the warm side of the insulation, a suitable product would be *Protect BarriAir* – an air barrier membrane with some vapour control properties.

### Cold Roof: with large voids above horizontal insulation using impermeable underlays (type HR)

Vapour impermeable underlay = Figures are given in 000s of mm<sup>2</sup> per metre, e.g. 5 = 5000mm<sup>2</sup>/m

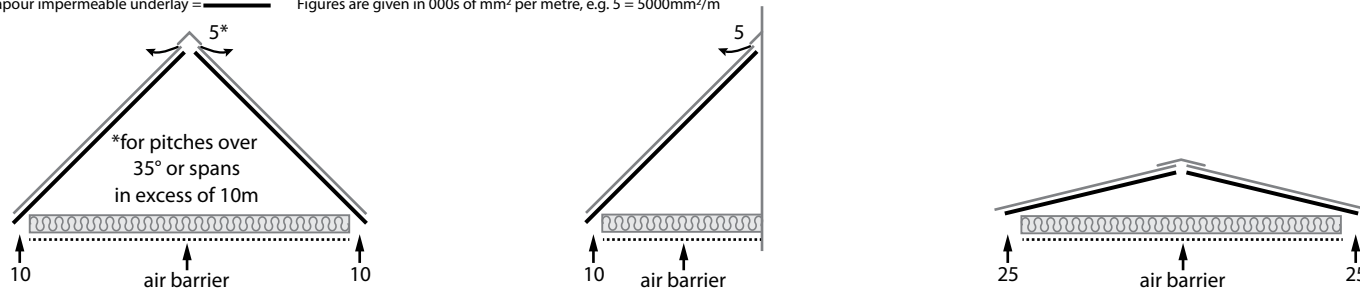

## Warm Roof Applications

When installing TapcoSlate Classic onto either battens or directly onto OSB a **vapour impermeable (type HR)** roof membrane/underlay should be used. Insulation should follow the line of rafters, with a 50mm deep void between the top of the insulation and the underside of the underlay/OSB. This void to be ventilated in accordance with BS 5250. An air and vapour control barrier membrane to the warm side of the insulation must also be installed, we recommend the *Protect VC Foil Ultra* – low emissivity air and vapour control layer product.

Please note that the preceding is purely manufacturers guidance and should not supersede local building authority recommendations.

### Warm Roof: with small or no voids above sloping insulation using impermeable underlays (type HR)

Vapour impermeable underlay = Figures are given in 000s of mm<sup>2</sup> per metre, e.g. 5 = 5000mm<sup>2</sup>/m

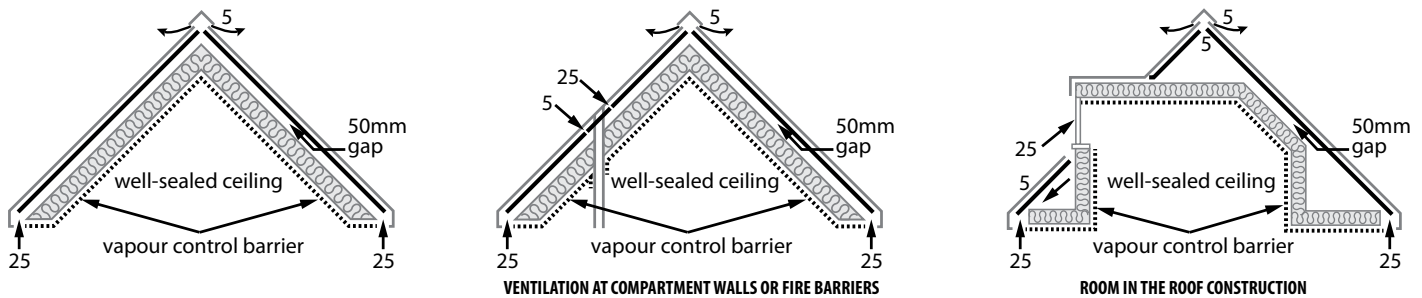

# – Installation Guidelines –

## Spacing Between the Slates

0.25" (6mm) spacer tabs are provided on every Classic slate to aid in maintaining consistent spacing. The spacers will allow for any movement of the roof deck and expansion/contraction of the slate (although thermal expansion is highly unlikely in European climates). **DO NOT remove the spacer tabs** unless finishing at the end of the course.

## Laying Out ½ Slates or Cut Slates

When beginning or finishing with a cut piece of slate, the cut edge should be installed inward. The manufactured edge should be installed to the outside edge of the roof. This is to maintain an acceptable roof appearance along the gable edge of the roof.

The centre mark of the slate can be used as a guide to cut ½-slates. This can also be used as a guide to keep courses straight and to assist in maintaining the proper Classic slate 0.25" (6mm) spacing when aligning with intermittent vertical chalk lines. **DO NOT install slates smaller than 3" (76mm).**

## Preparation

Inspect all areas of the roof surface to be covered.

1. The surface area must be uniformly flat, smooth, sound, clean and free of irregularities.
2. Examine roof sheathing to verify that sheathing joints are supported by framing and blocking and/or metal clips.
3. Verify that substrate is sloped for drainage and completely anchored to sound framing. Any foreign particles shall be cleaned from interlocking areas to ensure proper seating and to prevent moisture intrusion and ice damming. Proper provisions must be made for flashings and roof penetrations.
4. Even though metal flashing and other specialty flashings may not be the responsibility of the roofing contractor, these items must be in place prior to the roof slate installation. Work by other trades which penetrate the roof plane must be completed.

## Hip Roof Layout

1. Initial starting points may be from left side, right side or centre of the area to be installed. Mechanical 0.25" (6mm) spacer tabs are provided on every Classic slate.
2. A full Classic slate should be cut into ¾ size, approximately 12" (305mm), to create an eaves or starter slate for the starter course and at the ridge if necessary.

3. One method of starting on a hip roof is to locate the centre of the roof area to be covered. From both ends, position starter pieces and snap a horizontal line from the tops of the starters between these two points. Next, snap a vertical perpendicular line. This can be done easily by marking 3ft (0.91m) along the eave, then where 4ft (1.22m) and 5ft (1.52m) intersect will form a perpendicular line. As long as the ratio 3:4:5 stays the same this will hold true, for example, 21:28:35. More horizontal and vertical lines may be snapped to ensure the roof slates will stay true and plumb throughout installation. Begin by placing an eaves slate on the right and left side of the vertical line maintaining a 0.25" (6mm) or 0.5" (13mm) spacing, depending on slate type used, and continue to both ends.

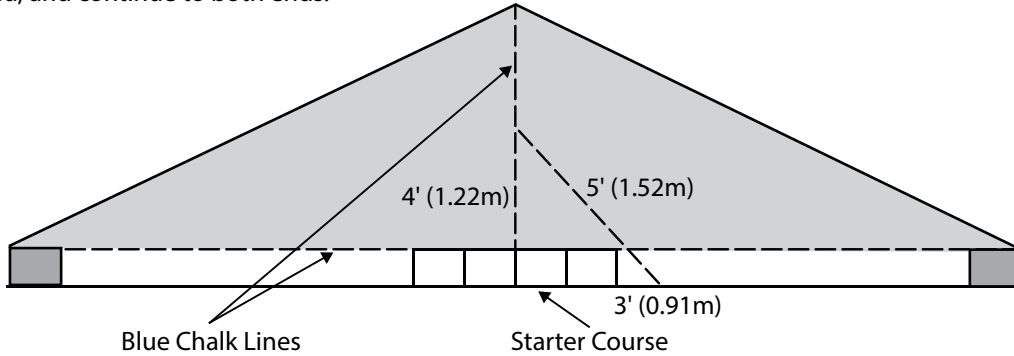

- 4. The eaves and first course should overhang a maximum of 1½" (38mm) at the eaves for the gutter oversail.
- 5. Begin the first course. With a full slate, align centre locator line of the slate directly over the vertical blue chalk line. Continue to both ends, maintaining the 0.25" (6mm) spacing, depending on slate type used, between slates. (See diagram above.)

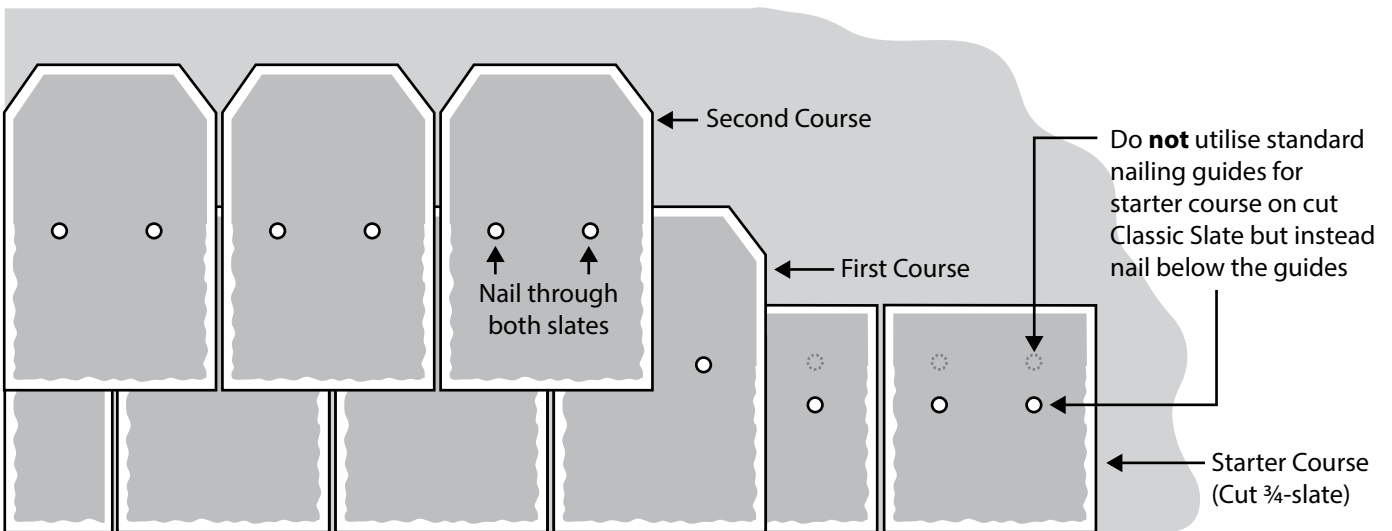

6. After installing the underlay or membrane and before installing the TapcoSlate, clean the surface of debris and dirt. Foreign particles shall be cleaned and removed from interlocking areas to ensure proper seating of the product and to prevent moisture intrusion and ice damming. All roof penetrations shall be properly flashed and secured into position with deck and underlay or membrane fasteners properly driven and not protruding prior to installing TapcoSlate Classic.

- a) The eaves or starter slates will be used as the first row at the eaves of the roof.
- c) To create the offset from course-to-course, use the centre mark provided on each slate and cut the slate lengthwise. This ensures that the nail holes are covered with the next course of slates and no through-joints are exposed to the deck.
- d) Strike the chalk lines horizontally, at the exposure level desired, to ensure that the slates are installed straight and uniform. Vertical chalk lines will help maintain consistency in the key-ways.

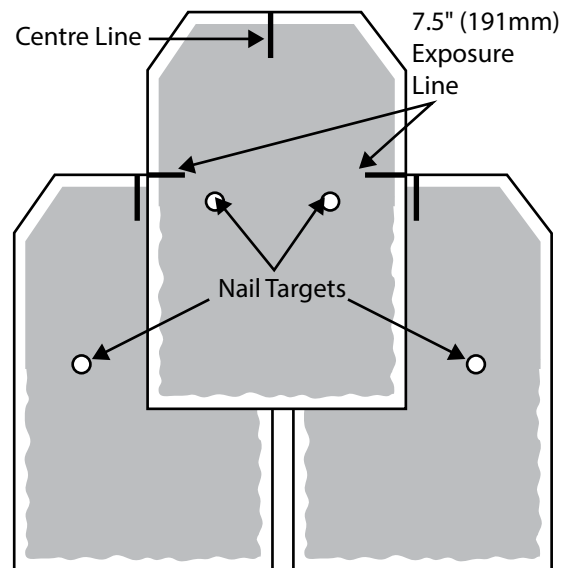

- e) Spacer tabs are provided on each Classic slate to ensure consistent spacing between slates.
  - f) There shall be no through-joints from the roof surface to the underlay or membrane.
7. Each slate shall be fastened with a minimum of two galvanised, stainless steel or outdoor roofing fasteners (clout nails or screws).
- a) It is required that the fasteners be placed within the two nailing targets on each slate. Flatten slate then fasten. Fastener must penetrate decking at least 23/32" (18mm).
  - b) Caution should be taken where the underside of the roof decking is exposed to view, such as in an overhanging eaves, where the nails or screws should be long enough to penetrate the roof decking but not so long that they may be driven through the decking.
8. Continue the second course with a full standard slate set back from the course below, the finished edge facing the gable edge. Align the full roof slate between the centreline locators from the lower course. Next, adjust the roof slate up or down to align the desired exposure lines with the top edge of the lower course. (See diagram on page 9, and roof pitch table information on page 4 for which exposure line to use.)

## Fully Boarded Roof

The following instructions are just a guide, and standard roofing procedures should be applied. Apart from the lightness and ease-of-use that TapcoSlate affords, there is very little difference between it and standard slate in fully-boarded roof application. The **most cost-effective way** to fix TapcoSlate to OSB is to first use a **vapour impermeable** roof membrane/underlay, along with, we recommend, either an air barrier on the warm side of the insulation for Cold Roof applications or an air and vapour control barrier membrane to the warm side of the insulation for Warm Roof applications (see the "Roofing Membrane/Underlay" section on page 5 for more details). Alternatively, a vapour permeable roof membrane/underlay can be used along with the application of counter battens on top of the membrane. The same vapour/air barriers are also recommended for Cold/Warm Roof applications using this counter batten method and a vapour permeable roof membrane/underlay.

### The Different Roof Structures Using Vapour Impermeable and Vapour Permeable Membrane

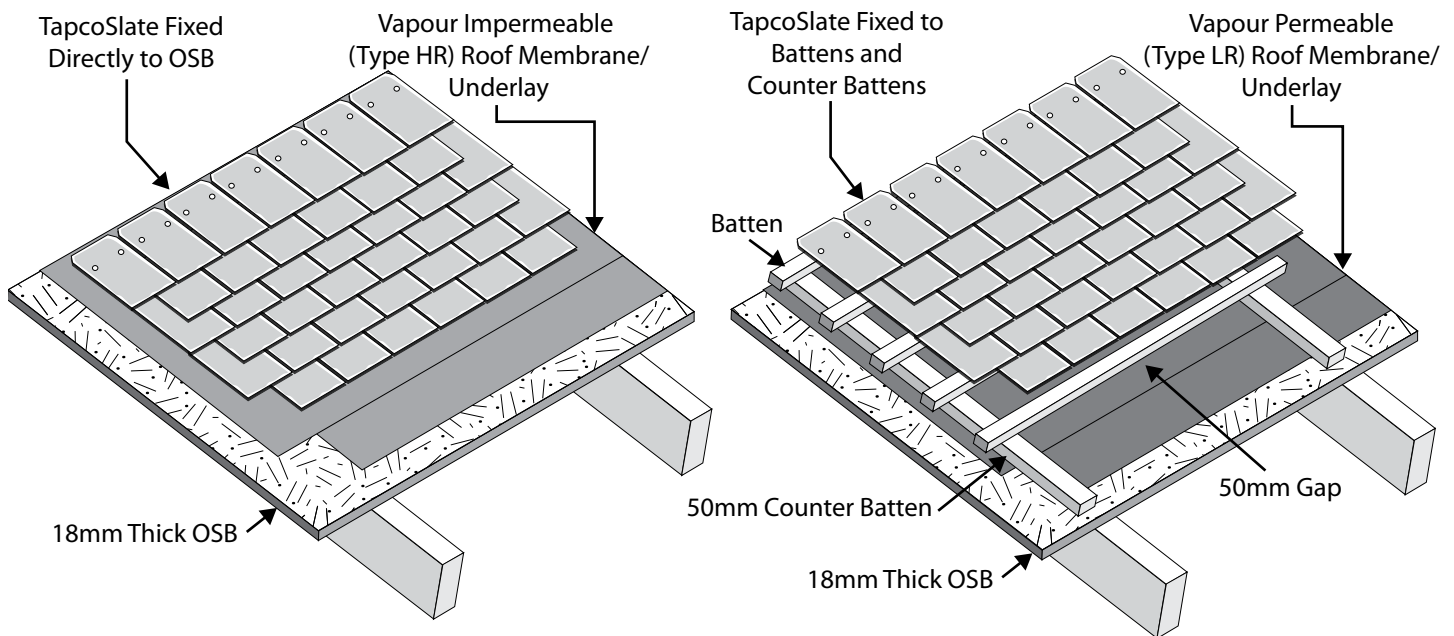

Being a laminar product, TapcoSlate repels water and does not absorb it, this means that water penetration is non-existent from the roof surface itself. However, vapour/air barriers minimise the risk of moisture accumulating on the underside of the slates/OSB as the most common source of moisture is generated inside the property itself. Using a **vapour impermeable** roof membrane/underlay reduces this risk even further.

The OSB sheeting should be a minimum 18mm thickness.



### Layout of a Fully Boarded Roof Using Vapour Impermeable Membrane/Underlay

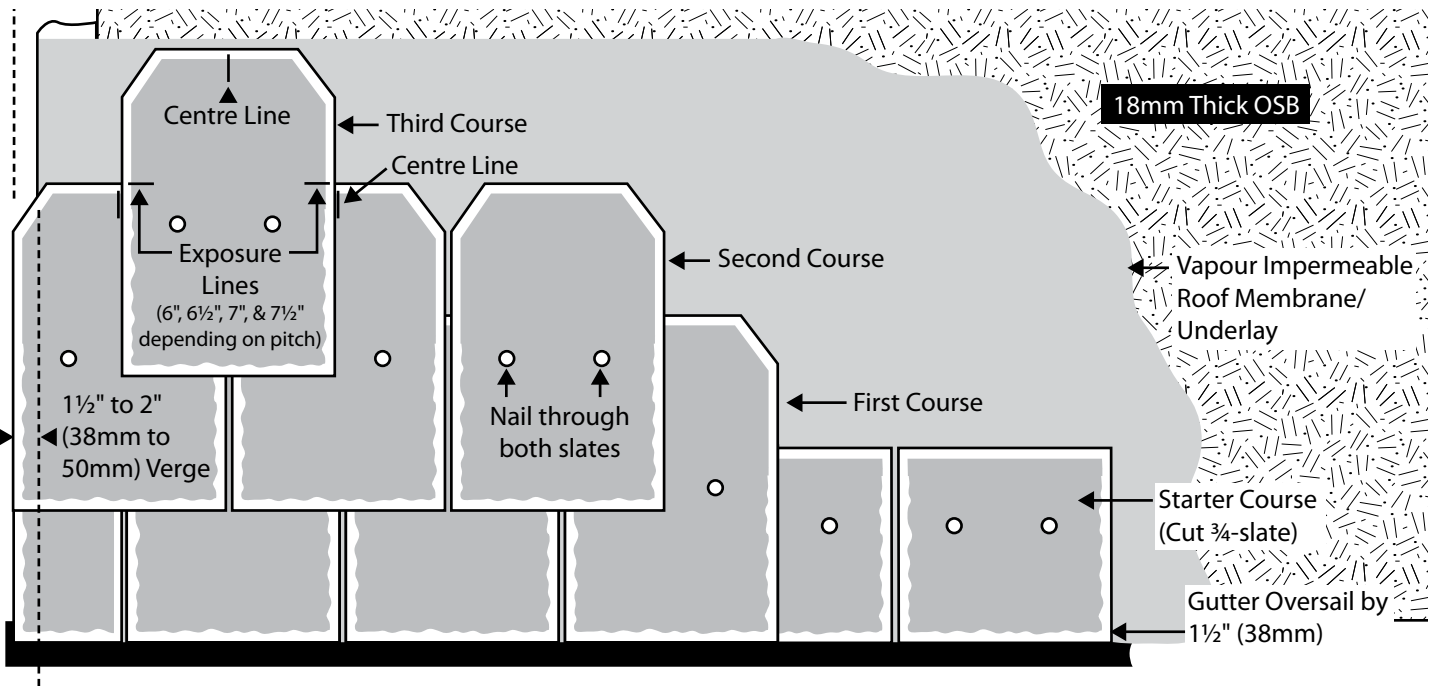

As can be seen by the above diagram, TapcoSlates can be nailed or screwed directly onto the OSB when using a **vapour impermeable** roof membrane/underlay. This is the **most cost-effective method** of fixing TapcoSlate onto a fully-boarded roof.

### Felt and Batten Roof

The following instructions are just a guide, and standard roofing procedures should be applied. Apart from the lightness and ease-of-use that TapcoSlate affords, there is very little difference between it and standard slate in batten roof application. The **most cost-effective way** to fix TapcoSlate to battens is to first use a **vapour impermeable** roof membrane/underlay, along with, we recommend, an air and vapour control barrier membrane to the warm side of the insulation for Warm Roof applications (see the "Roofing Membrane/Underlay" section on page 5 for more details). No other barrier membrane is needed when using the **vapour impermeable** membrane in a Cold Roof situation. Alternatively, a vapour permeable roof membrane/underlay can be used along with the application of counter battens on top of the membrane. The same air and vapour control barrier membrane is also recommended for Warm Roof applications using this counter batten method and a vapour permeable roof membrane/underlay.

### The Different Roof Structures Using Vapour Impermeable and Vapour Permeable Membrane

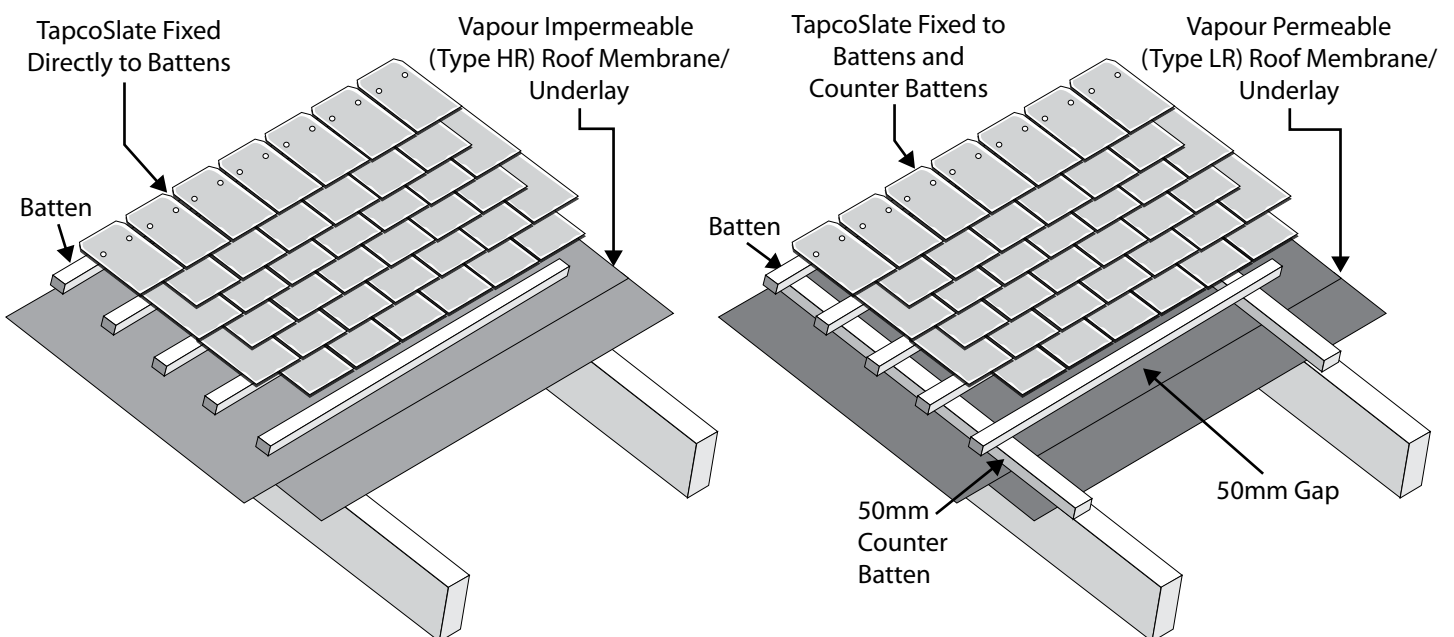

For felt and batten roofs, start by fixing battens – minimum size of 2" (50mm) by 1" (25mm) treated battens – over underlay to the required gauge. The first course and eaves (starter) course should oversail the fascia by at least 1½" (38mm), so the first course batten should be placed approximately 7½" (190mm) centrally from the start of the roof (see diagram). A second batten should then be placed directly under the first course batten to accommodate the eaves or starter course (made from a cut ¾-slate).

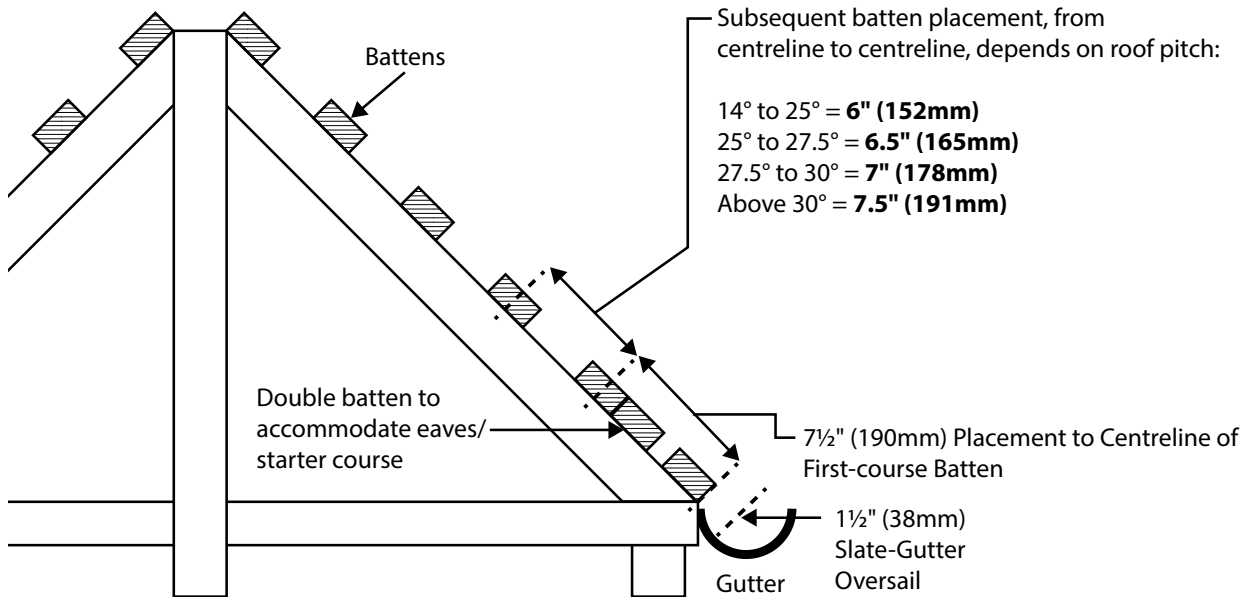

The distance from the first course batten to the second course batten, and beyond, is dependent on the roof pitch and subsequent slate exposure gauge settings. Please see the diagram of the TapcoSlate and the Pitch, Gauge, and Coverage table on page 4. The diagram above also shows an approximate guide to subsequent batten placement.

The position of the top battens should then be established to ensure that the top course of slates will be covered by the ridge cap.

Fix eaves, or starter course using a ¾-cut slate for Classic Slate which can be easily cut to size from a full slate using a fine-toothed hand/circular saw or a sharp utility blade. As stated earlier, the first course and eaves (starter) course should oversail the fascia by at least 1½" (38mm). This ensures water disperses into the centre of the gutter. This must be taken into account when calculating the gauge and positioning the battens.

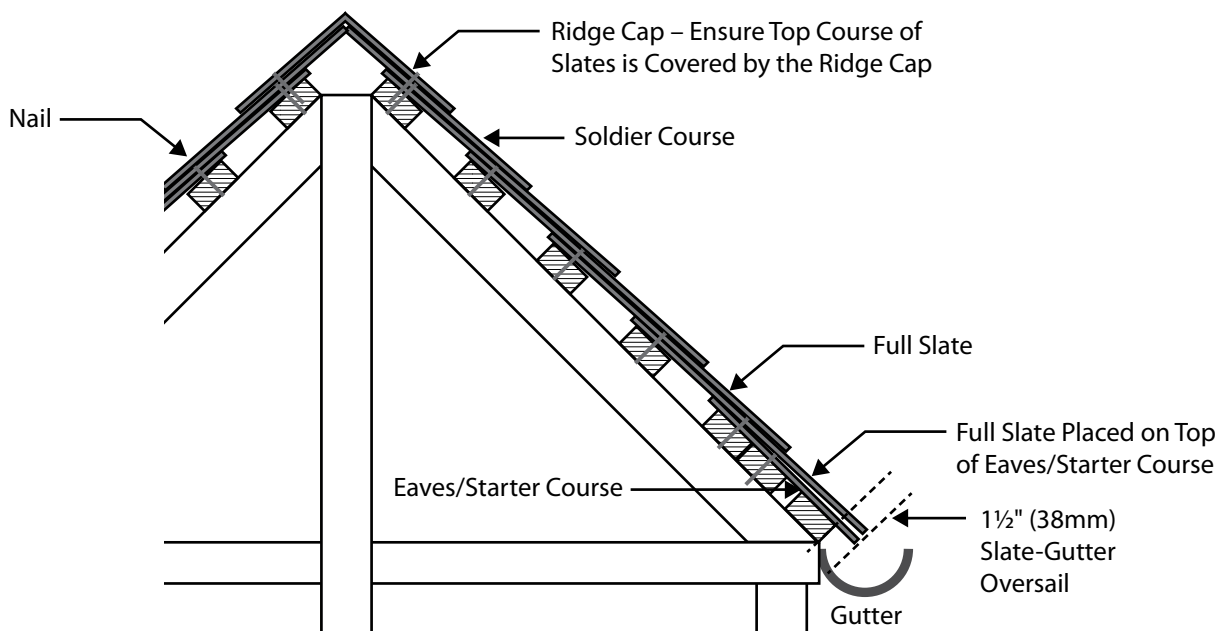

The required gauge and number of courses can then be calculated. The first course should sit on top of an eaves course. Double batten as shown in the diagram to accommodate the eaves slates.

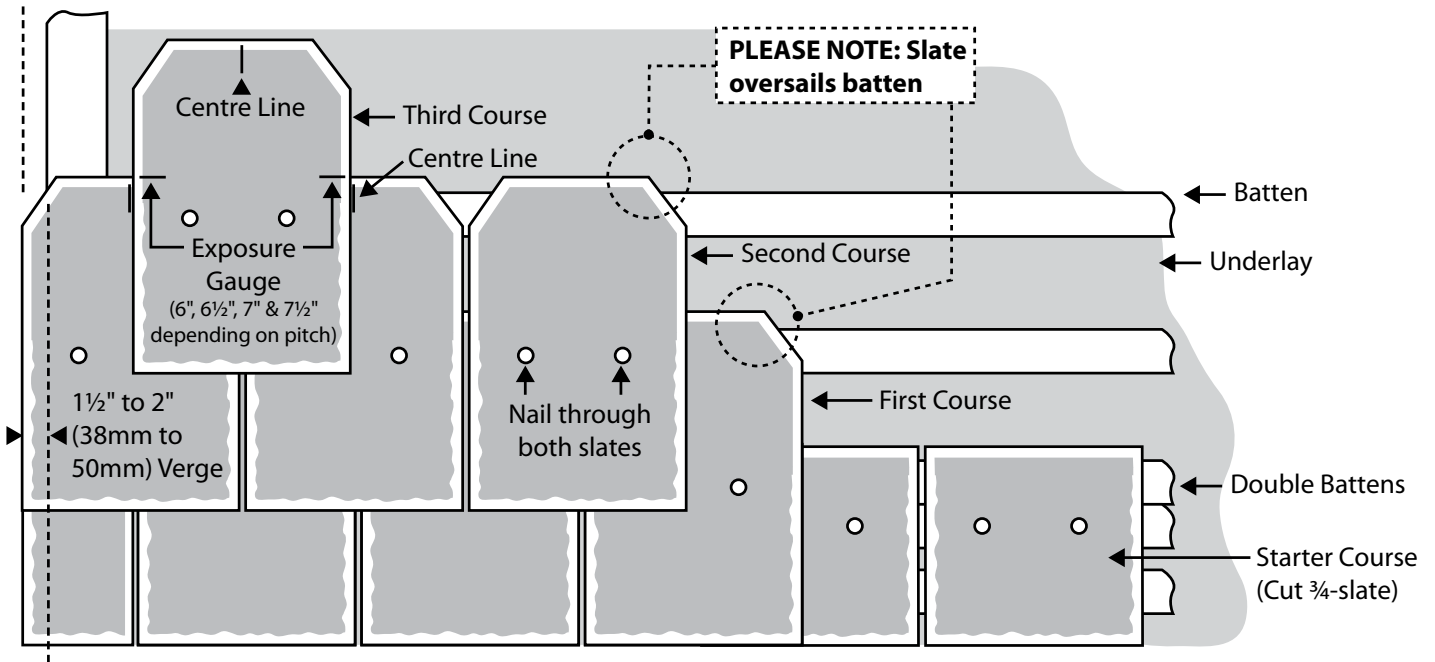

Verge slates should oversail the brickwork/barge board by 1½" (38mm), and may need to be cut to size at either end.

Lay the first course of full slates over the eaves course and fix to the second batten. Ensure that the first course and eaves course are laid "broken bond" so that the joints do not line up and the weatherproofing integrity is maintained.

Lay subsequent courses "broken bond" as illustrated. It will be necessary to cut to start and finish every other course.

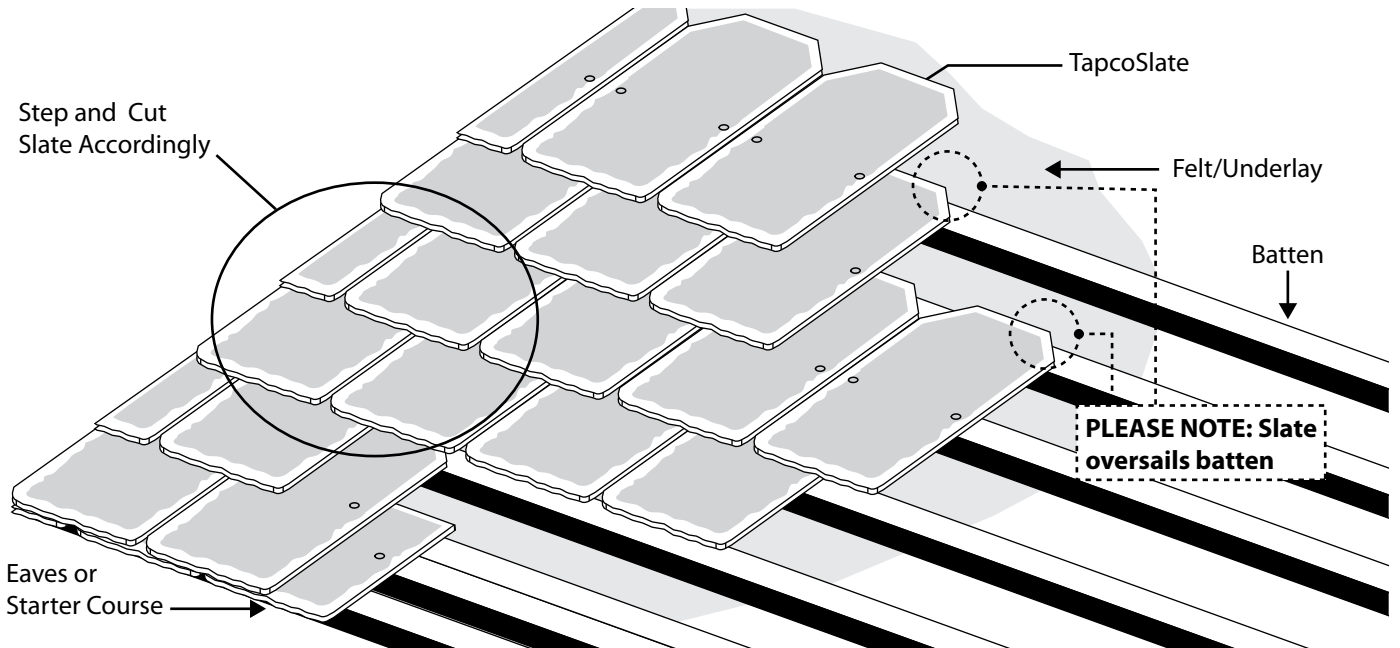

## Fixing TapcoSlate Ridge/Hip Caps

Just like our slate tiles, our ridge and hip caps have an exposure guide embossed onto them. Caps on the ridge must be fitted at a maximum of 7.5" exposure, we recommend the minimum exposure of 6" for high-wind/driving rain exposed areas. Caps on the hips **must** be fitted at a 6" exposure. All caps should be nailed/screwed through the one below, similar to the tile layout, and must be secured in the indicated spaces provided using two fixings – once completed this gives four fixing points on all but the last end cap. Do not over-expose the caps. The minimum number of caps per linear meter is 5.5 (at a 7.5" exposure). The maximum number of caps per linear meter is 6 (at a 6" exposure).

### Maximum Classic Ridge Cap Exposure (7.5")

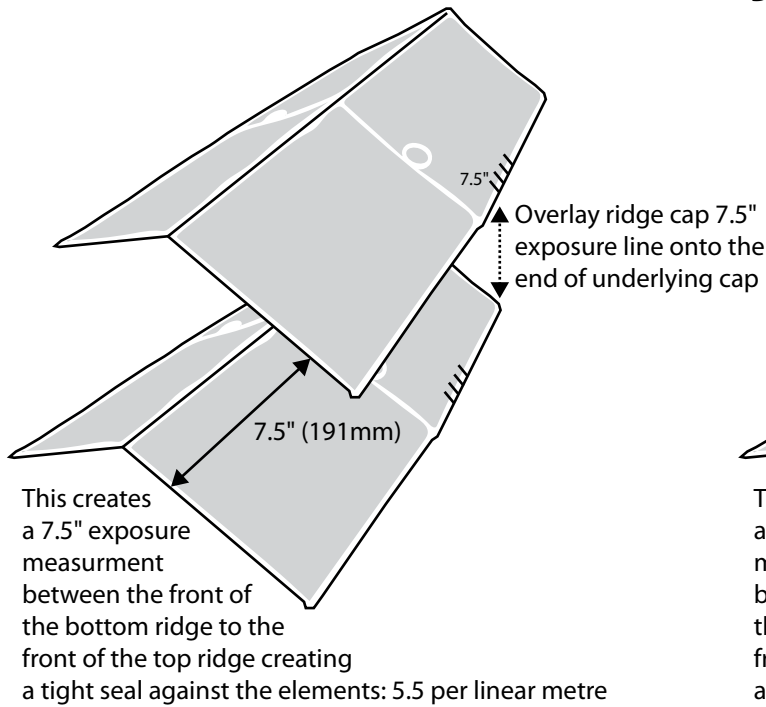

### Minimum Classic Ridge Cap Exposure and Definitive Classic Hip Cap Exposure (6")

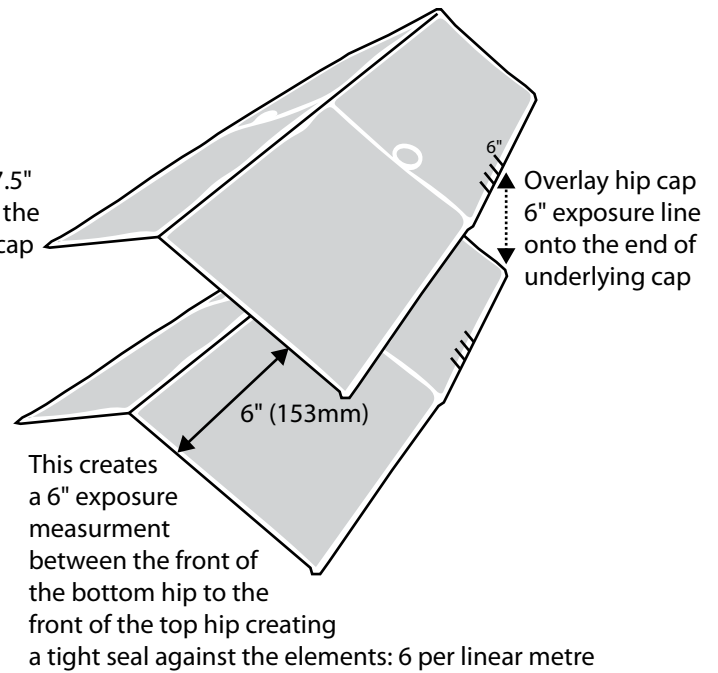

### Ridge and Hip Cap Fixing

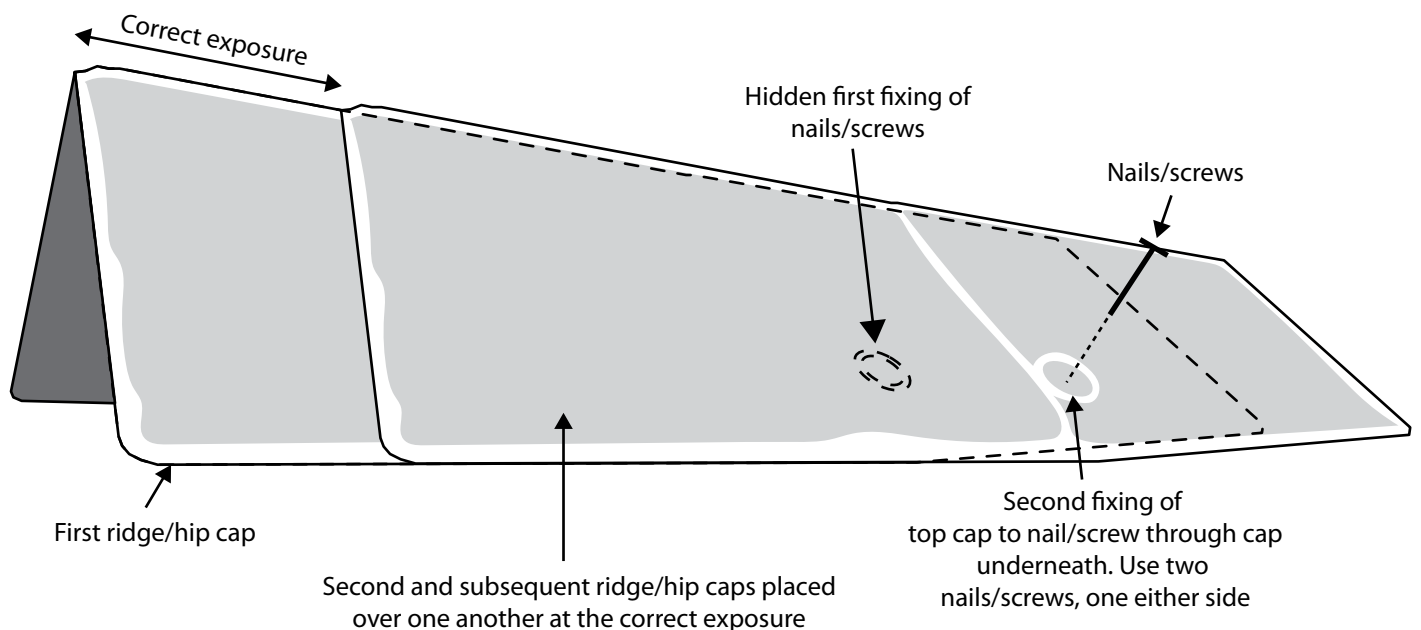

## Ridge/Hip Cap Finishing

Tapco Roofing Products produces pre-formed TapcoSlate Classic Angled Ridge-to-Hip Junctions and TapcoSlate Classic Ridge 90° End Caps for the following roof pitches:

### Classic Angled Ridge-to-Hip Junction

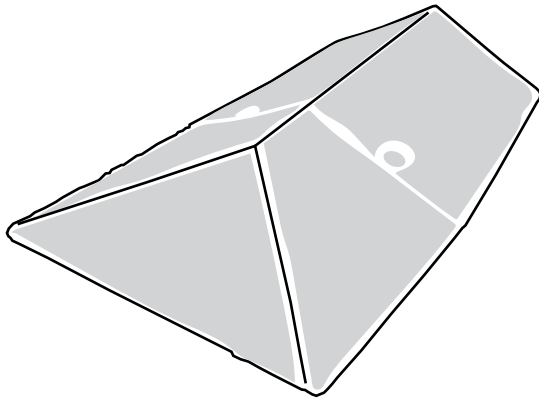

Available in:  
14 to 17°  
18 to 23°  
24 to 30°  
Roof Pitches

### Classic Ridge 90° End Cap

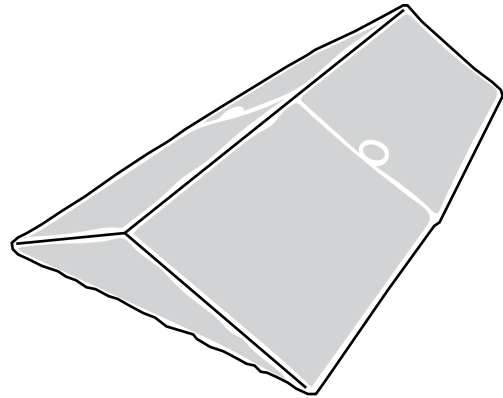

Available in:  
25 to 29°  
30 to 34°  
35 to 40°  
Roof Pitches

The TapcoSlate Classic Angled Ridge-to-Hip Junctions and TapcoSlate Classic Ridge 90° End Caps are fixed in place the same way as standard hip and ridge caps, two 3" (76mm) galvanised or stainless steel clout nails or outdoor Phillips Bugle screws. Care should be taken to store and transport these units safely. If a unit is to be used at both ends, the last unit can be cut in half and sculpted using a sharp craft knife to mimic the notched look of a cut slate: nails and screws in the top surface can be disguised by painting the heads in bitumen, or alternatively a colour-matched screw cap can be used or black tacks.

### TapcoSlate Classic Angled Ridge-to-Hip Junction (Also 3-Way for Edwardian Conservatories)

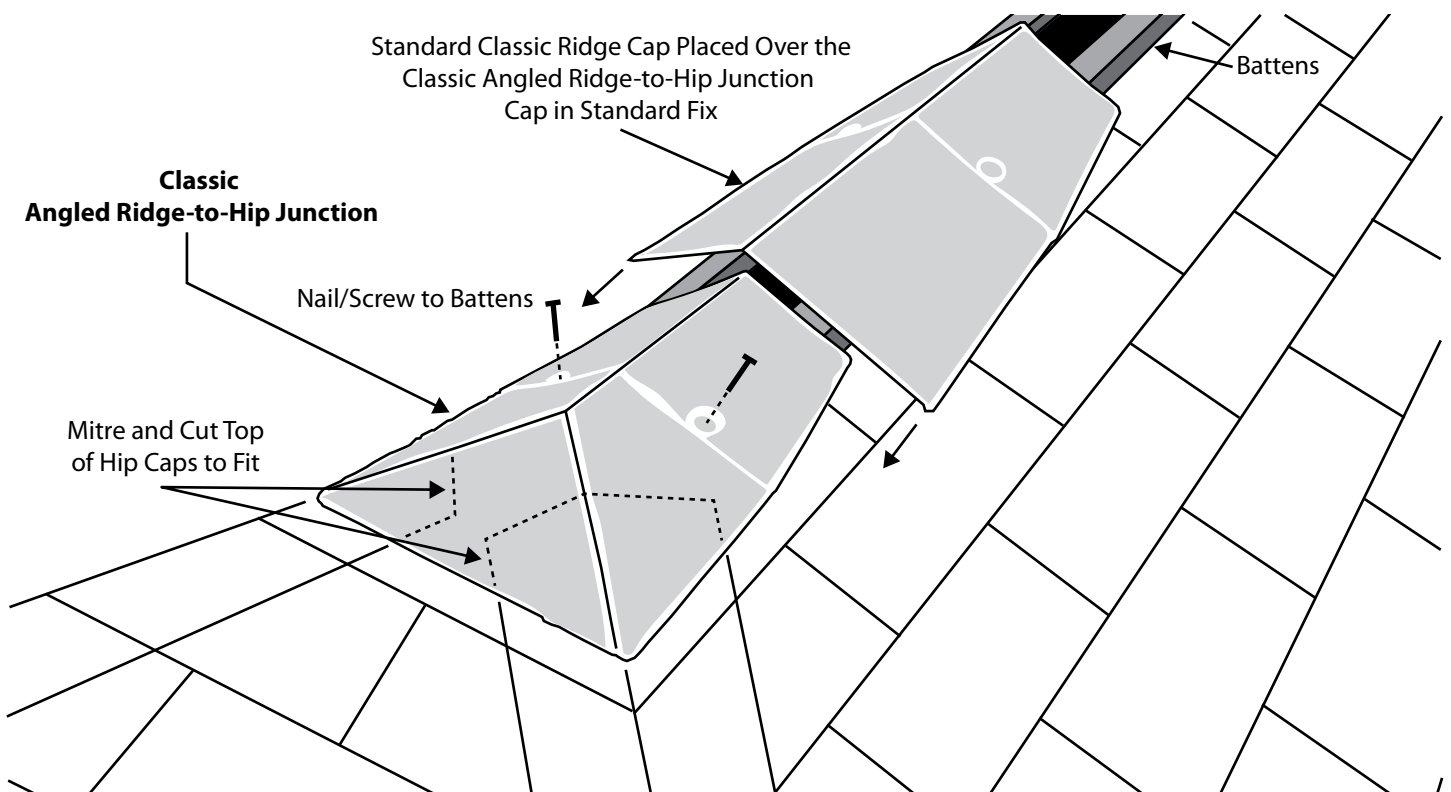

**TapcoSlate Classic Ridge 90° End Cap**

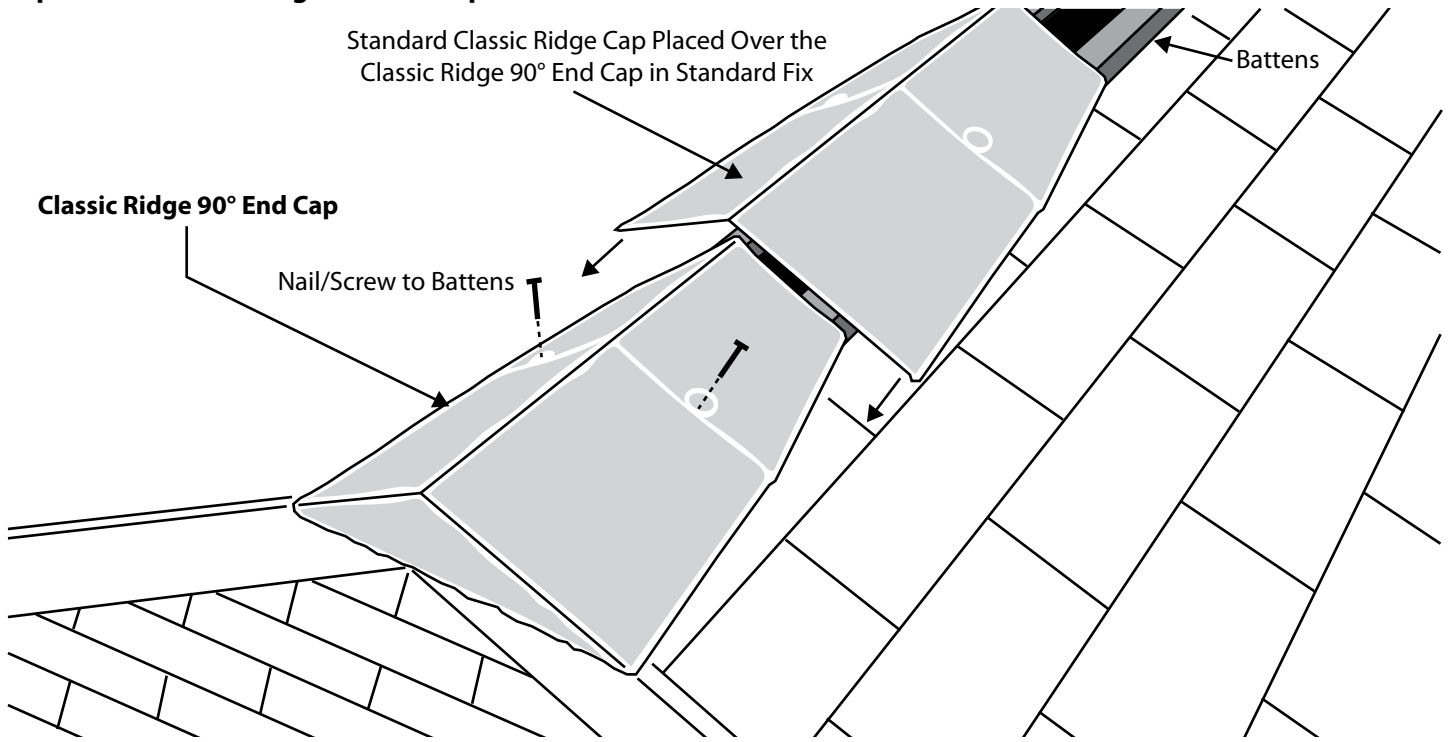

**Alternate Ridge/Hip Cap Finishing**

If you cannot use the pre-formed accessories mentioned due to pitch fitment or if you prefer to make your own the following is a guide on how to make similar finishes. Tapco Ridge Caps can be finished by cutting a standard TapcoSlate at the end of the ridge into a triangle or diamond shape of the right size to cover the end gap. The resulting material should then be nailed in place into the end-battens and/or truss. The material can be sealed by using a good quality butyl or bitumen sealant (do not use silicone as this will not adhere and may invalidate your warranty). Alternatively, the material can be joined to the Ridge Cap by using a strong epoxy glue (adhering to the manufacturers instructions). Nail heads should be disguised with coloured sealant or paint.

**Standard Ridge Cap End Piece**

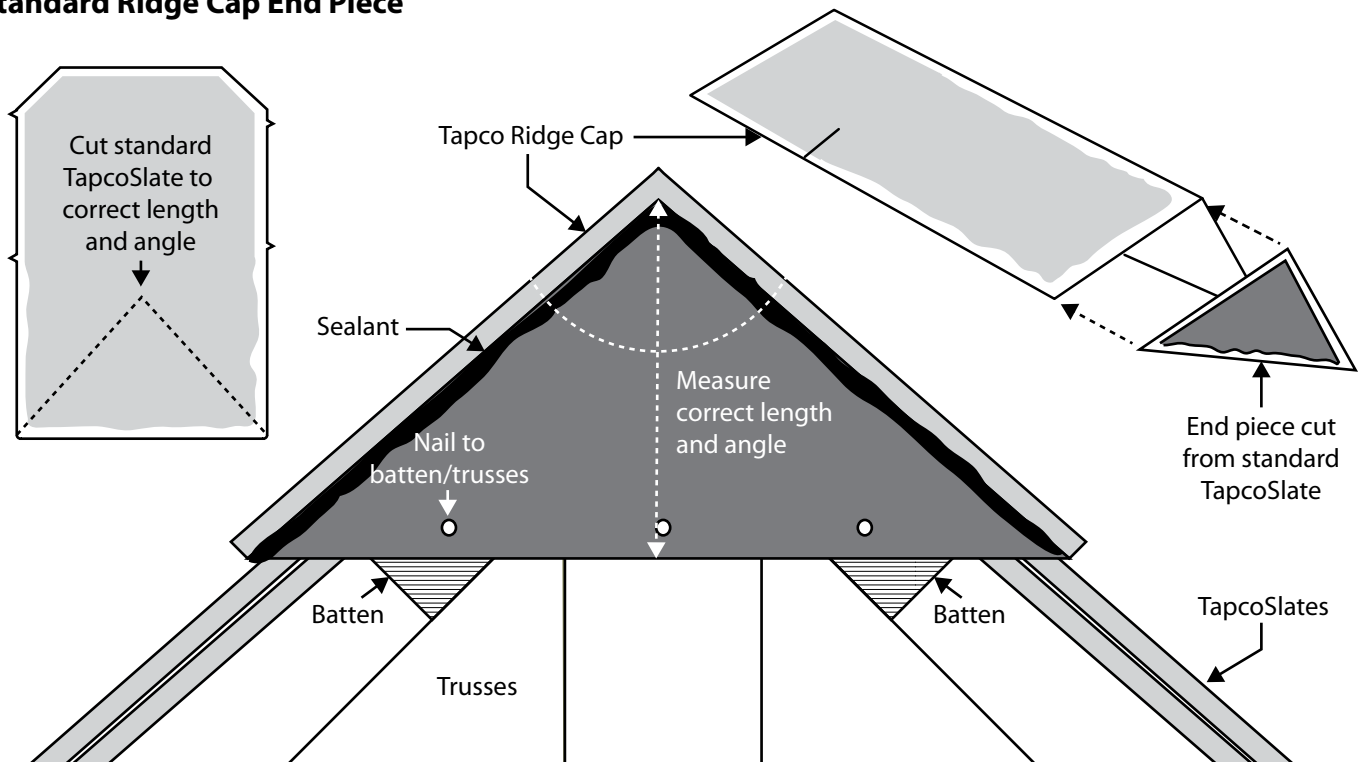

The same principle for finishing Tapco Ridge Caps can be applied to an angular finish roof by measuring the roof angle and cutting a Tapco Ridge Cap to suit. A similar measurement can be applied to a standard TapcoSlate to cut the right size and angle to cover the end hole in the Ridge Cap. Note that with an angular finish the material may have to be joined by using a strong epoxy glue (adhering to the manufacturer's instructions), unless there is enough batten/truss material to nail to.

**Angled Ridge Cap End Piece – Ridge to Hip Joint (& Edwardian Conservatory)**

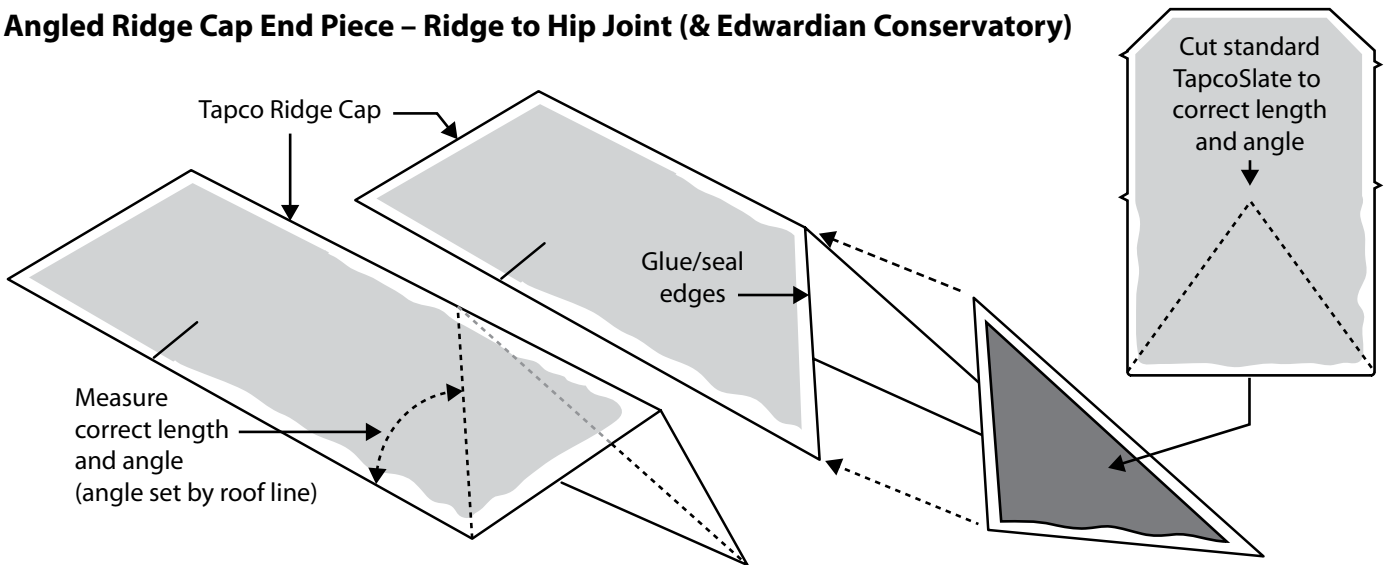

The 5-way ridge-to-hip intersection can be formed by setting chalk lines from the centre point of the three, flat triangular shapes created to the point (apex) of the roof. By placing TapcoSlate ridge caps under these lines and then striking the chalk line onto the caps, the Hip Caps can be cut to form the shapes similar to the above diagram. The Ridge Caps should be set as normal (no cutting necessary) and a cut-and-formed piece of TapcoSlate can be glued in place to fill the front edge. Please note, it is recommended to use a lead saddle at the ridge/hip joint to add another layer of weatherproofing (see page 16).

**5-way Ridge to Hip Joint (Victorian Conservatory)**

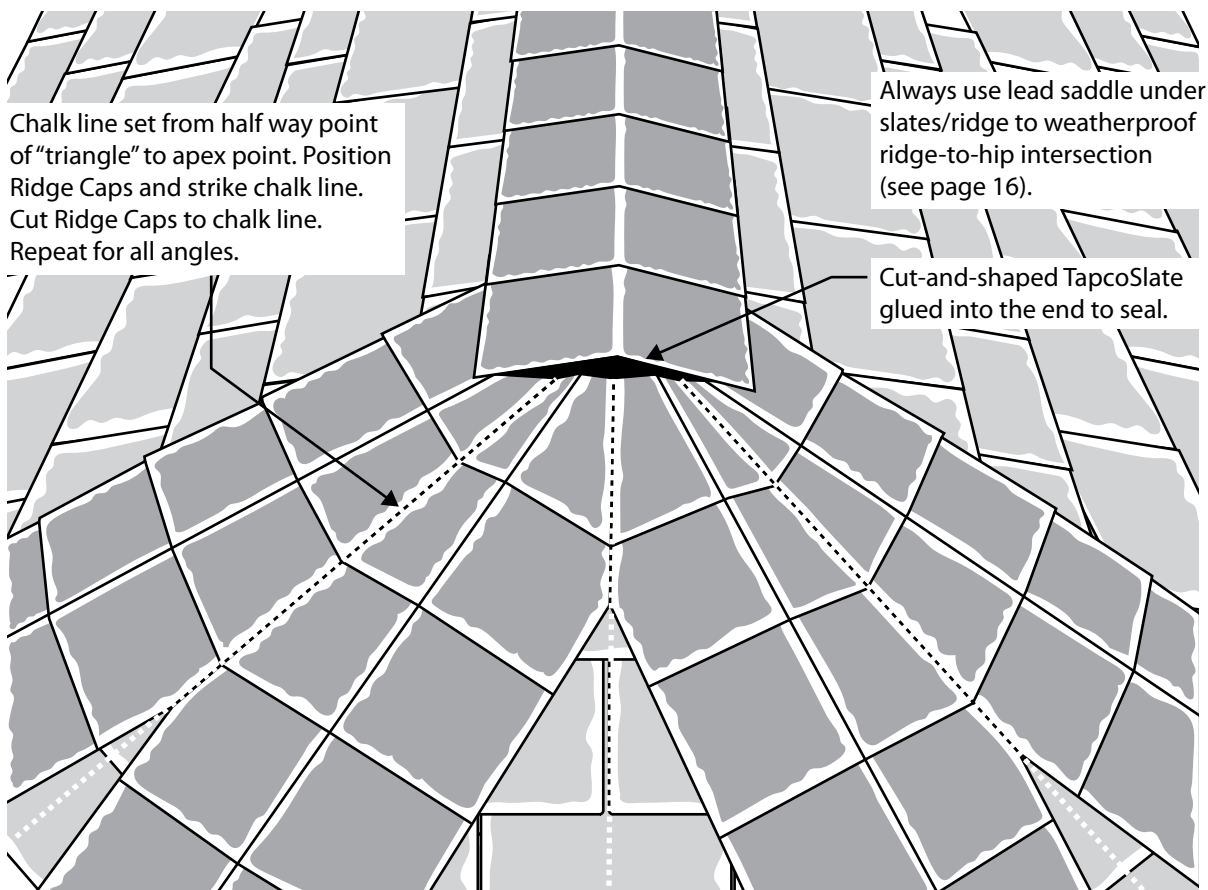

## Weatherproofing the Ridge-to-Hip Intersection

When making your own ridge-to-hip intersections and/or ridge end caps it will be necessary to weatherproof this intersection (not needed when using TapcoSlate pre-formed accessories). A lead saddle should be fitted to cover the intersection between the ridge tile and the mitred hip tiles. TapcoSlate hip tiles cut easily without splintering or cracking to effect a tidy mitred joint.

This principal can be utilised for any sized or shaped intersection.

### Lead Saddle Used to Weatherproof Ridge-to-Hip Intersection

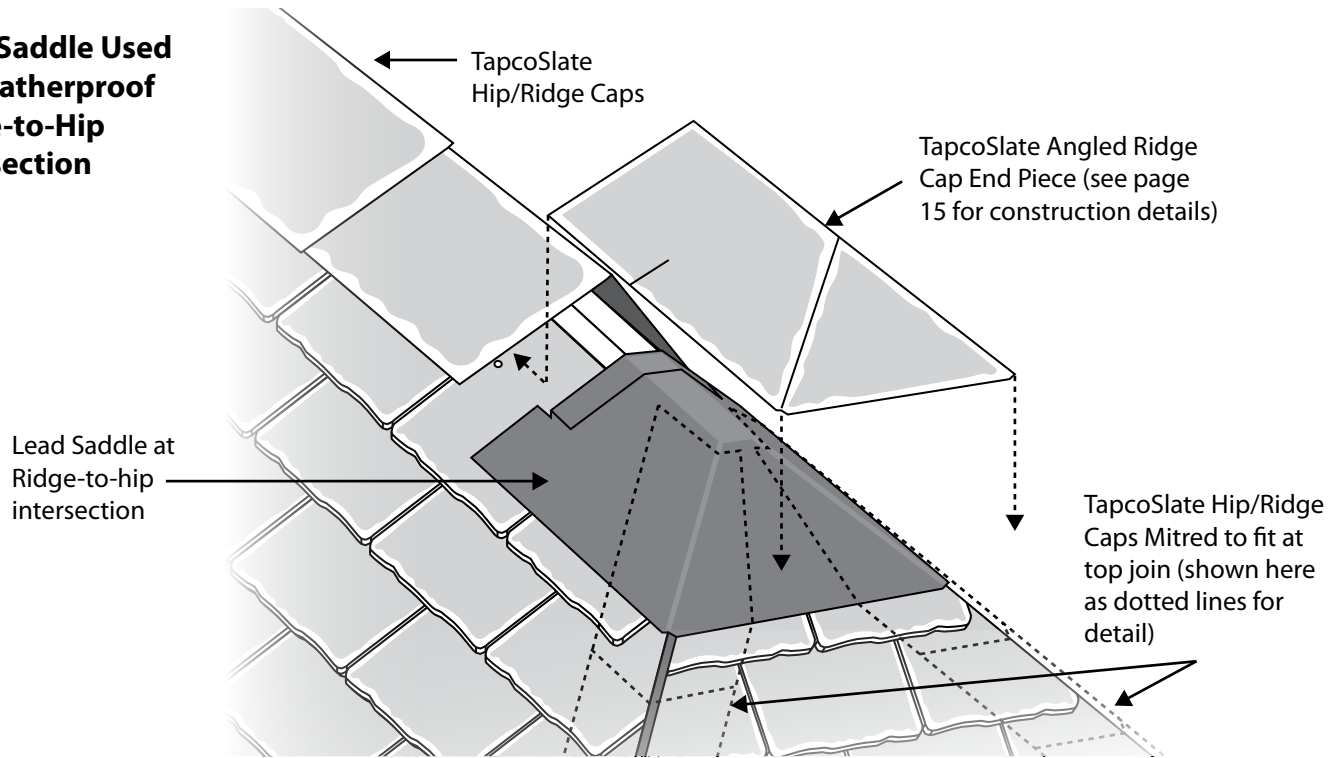

## Valleys

### Closed Valley Design

Closed valleys are formed by laying slates tight to the valley line and placing valley pieces under the slates. The length of the slate and the slope of the adjoining roof section determine the size of the valley. Valley material should extend 2" (51mm) above the top of the slate course that it will be applied to so that it may be fastened directly to the roof deck. Each valley piece should lap the piece below by at least 3" (76mm) and set in back of the butt edge of the slate above in order to be concealed. Each valley piece should be wide enough to extend 7" (178mm) from the centre of the valley to the roof surface. With a closed valley design, cut the slates in a straight line to fit no closer than 3/8" (10mm) against slate of adjoining roof slope.

### Closed Valley Design

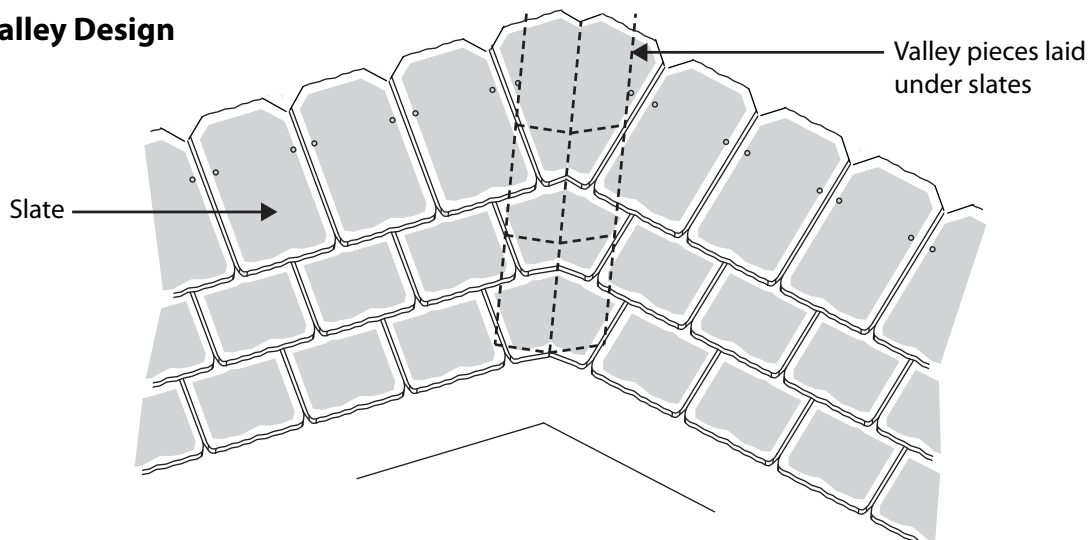



**Open Valley Design**

1. Install minimum 18" (457mm) wide "W" valley or "I" seam valley.
2. Fasten the valley every 2' (0.6m) using metal cleats.
3. Slate over valley by covering flashing by a minimum of 4" (102mm). Make sure not to drive fasteners from slate into the valley flashing.

**Open Valley Design**

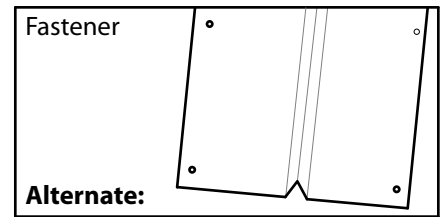
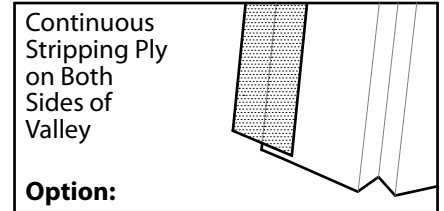
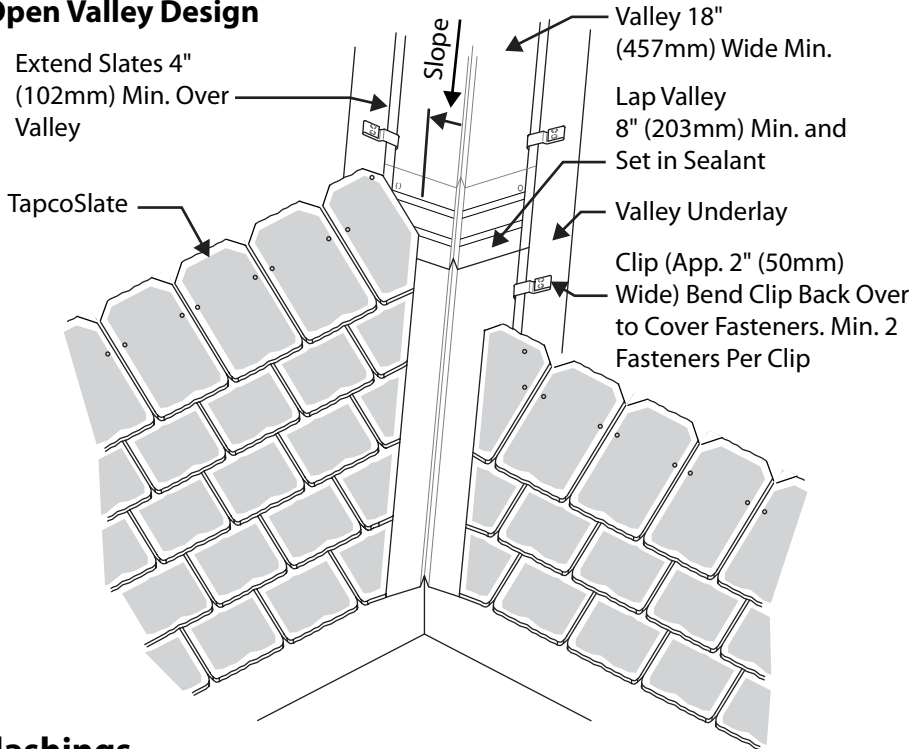

**Flashings**

Flashings should be used around all roof penetrations such as walls, chimneys, dormers, parapets, vent pipes, skylights, etc.

**NOTE:** When dissimilar metals are placed in contact with one another, galvanic corrosion will result which can cause electropositive metals to deteriorate. One way this can be avoided is by placing strips of sheet lead between the two metals.

**When using lead insure that a coat of patination oil is applied.** Tapco does not warrant metal components and accessories.

**Apron (Roof to Wall) Flashing**

Apron flashing is used when a roof terminates to a wall causing a course to be cut and face nailed. It is installed over the slates and behind siding or counter/cap flashing or dressed into brickwork/stonework, etc.

**Apron Flashing**

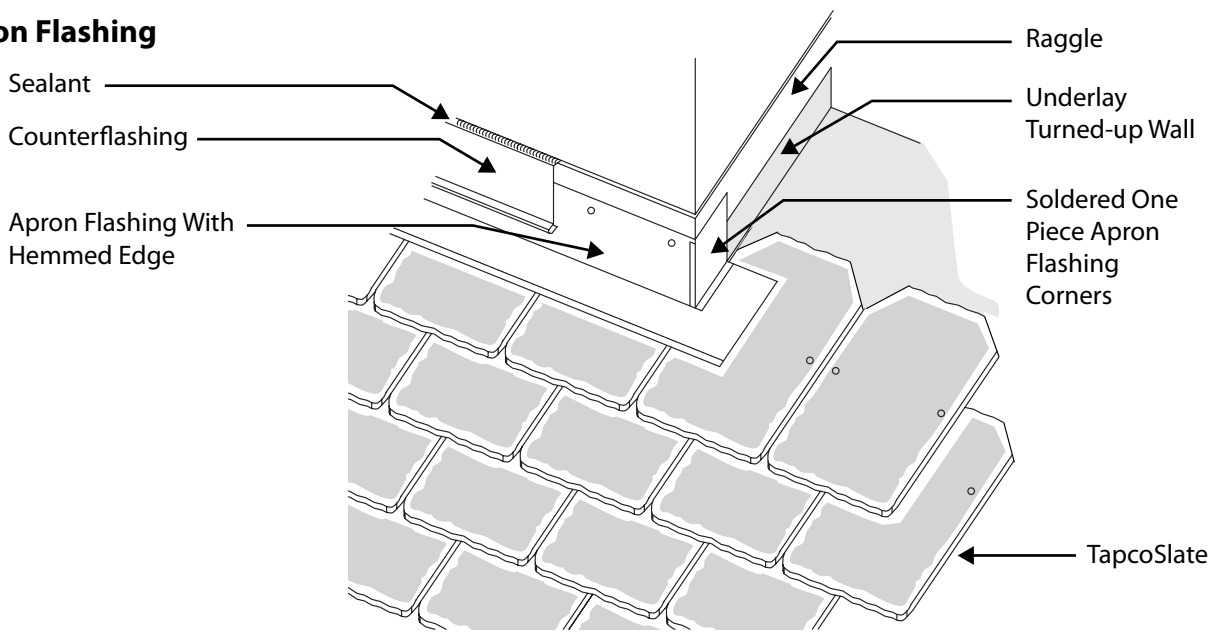

**Step Flashings**

Step flashings are used over or under the roof coverings and are turned up on the vertical surface. Step flashings should extend under the uppermost row of the roof slate the full depth of the roof slate or at least 4" (102mm) over the roof slate immediately below the flashing. The vertical leg of the flashing should be turned up a minimum of 4" (102mm) and extend 4" (102mm) on the roof slate with a 3/4" (19mm) hem. Flashings should have a minimum length of 9" (229mm) and must overlap a minimum of 2" (51mm).

**Step Flashing**

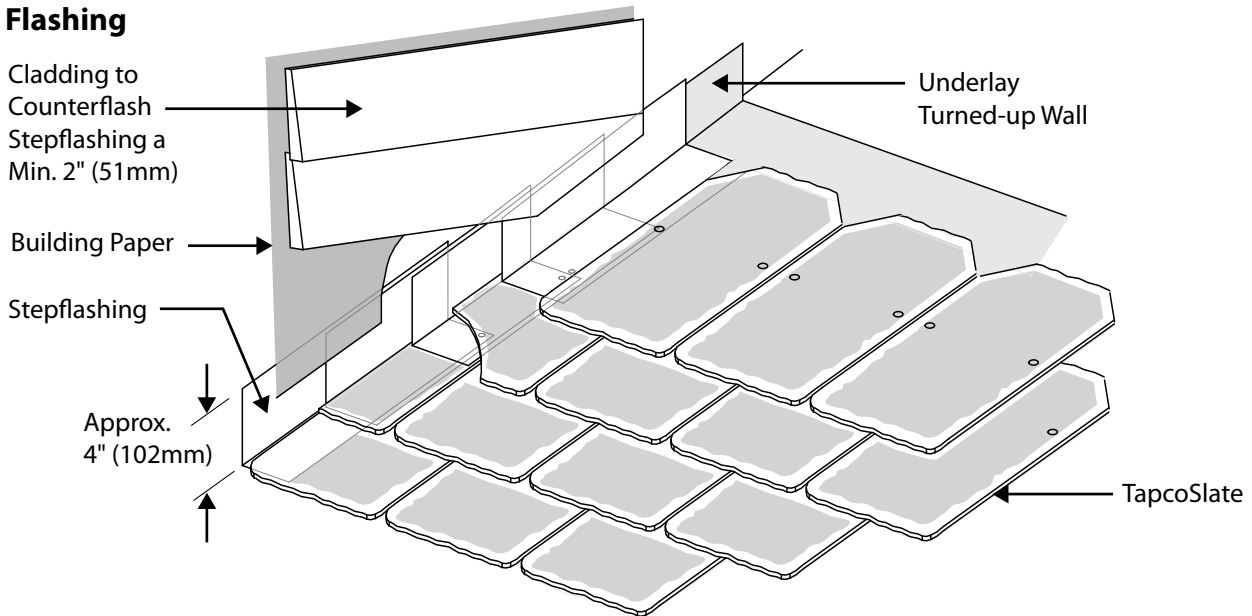

**Counter Flashing**

1. Cut a minimum 1" (25mm) deep reglet into the masonry material.
2. Custom bend the counter flashing to fit into the reglet.
3. Start by installing lowest piece first and work upwards for proper water runoff.
4. Fasten the counter using either expandable anchors or masonry screws.

**Counter Flashing**

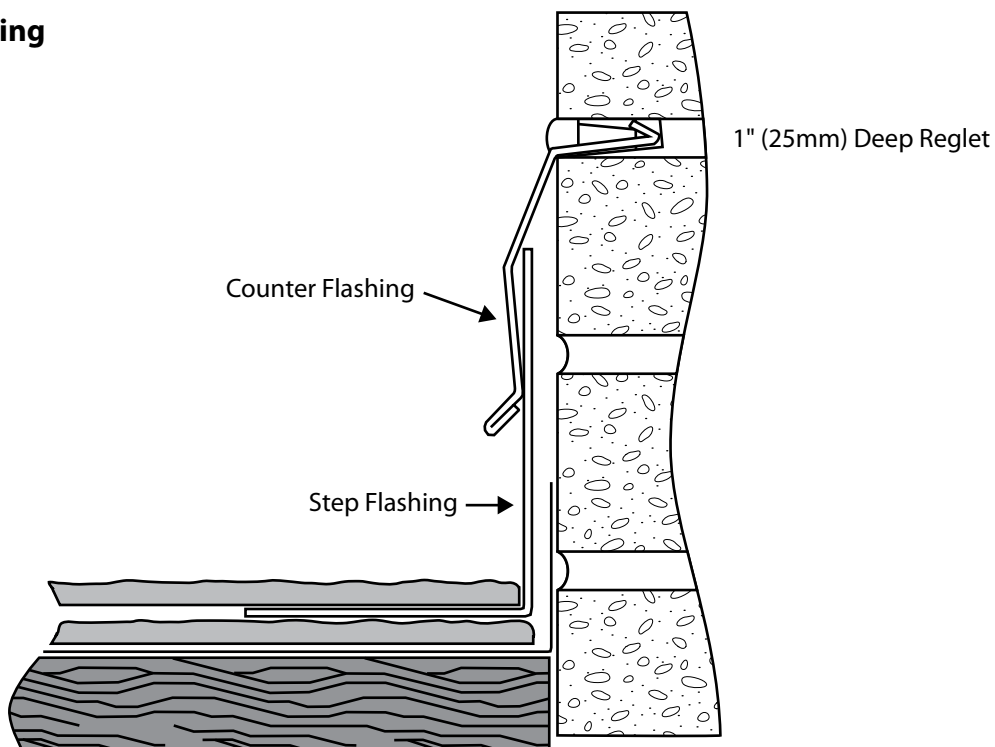

## Vent Flashings

Normal type of roof vents or flashings can be used. Extended-life materials should always be used.

### Soil Stack

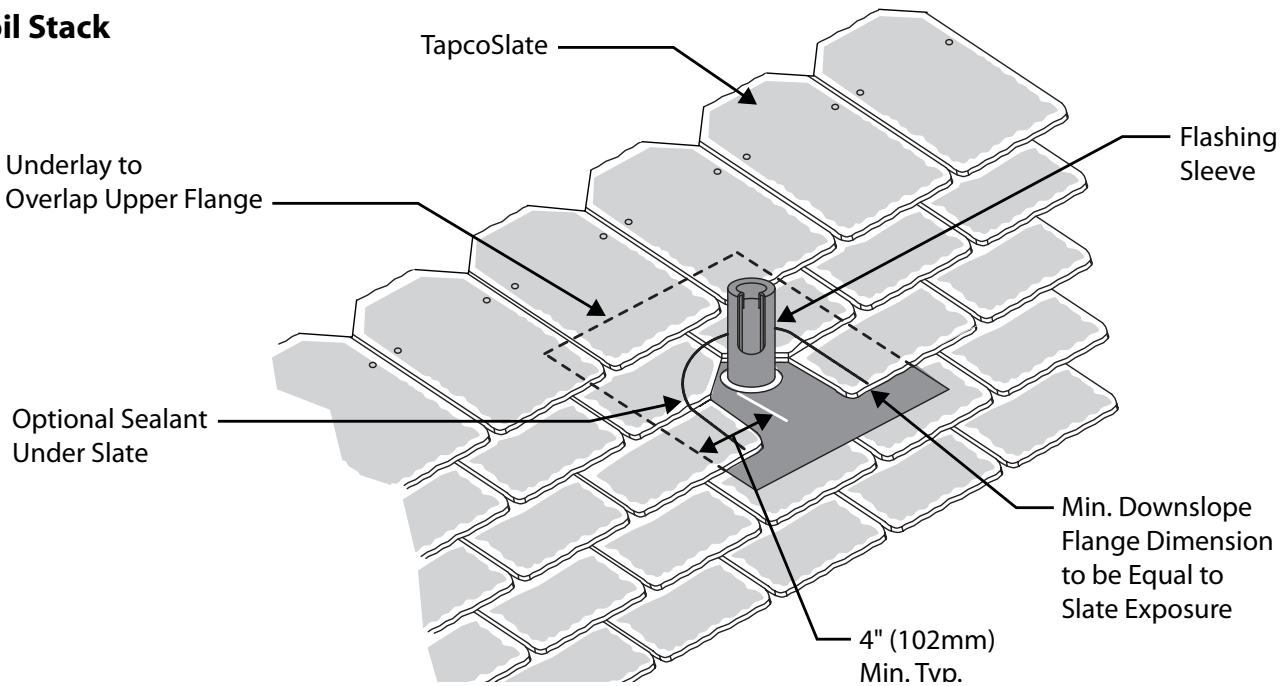

### Pitch changes

TapcoSlates can be installed onto rolling roofs with a gradual pitch change. Some roof designs, however, have drastic pitch changes where the use of flashing is necessary.

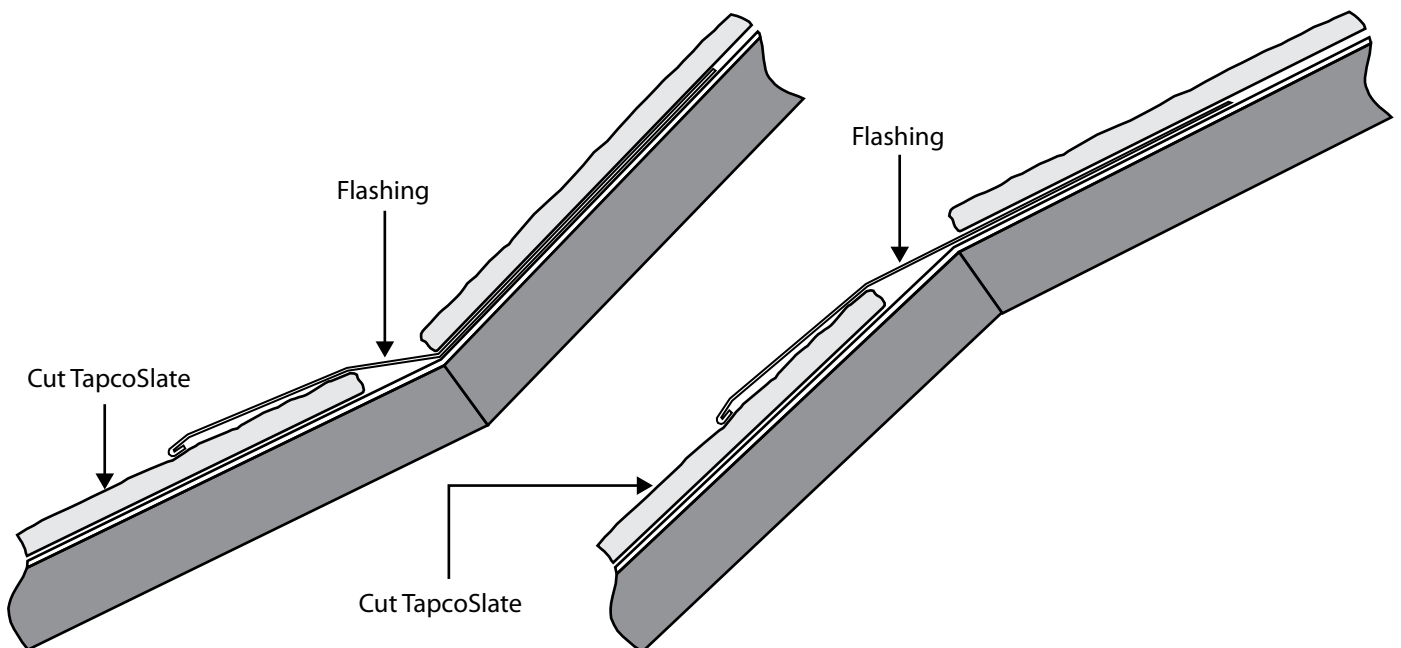

### Chimney Saddles

With chimneys more than 2' (0.6m) wide it is recommended that a saddle be installed to divert water from the back of the chimney. With chimneys less than 2' (0.6m) may only require a simple pan flashing.

**Pan Flashing View 1**

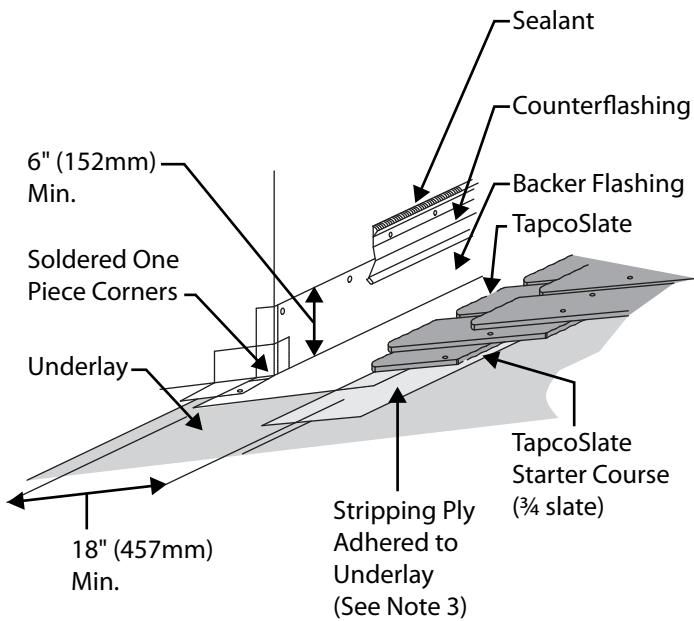

**Pan Flashing View 2**

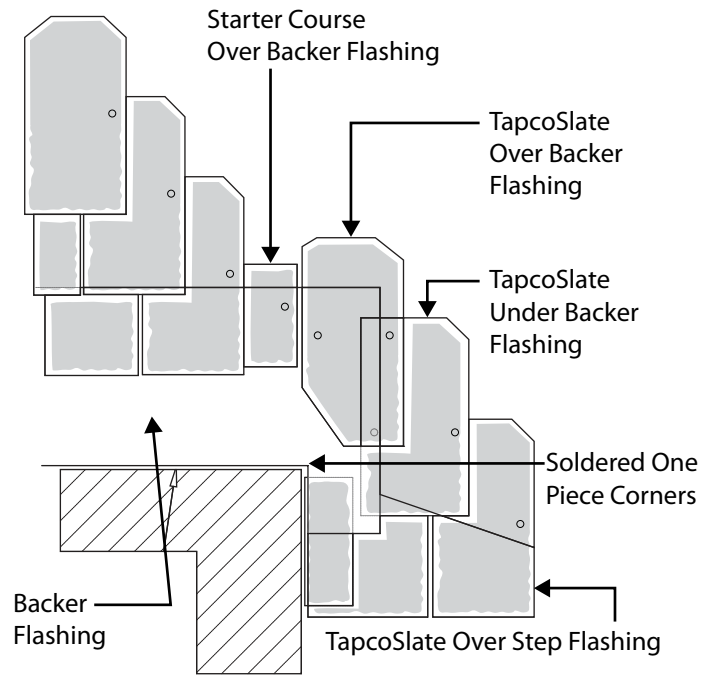

**Hip & Ridge Detail on a Boarded Roof**

When pre-formed hip & ridge slates are used, place nail at fastener guide targets. Fasten hip slates with 2 nails (one on each side). Maintain a 6" (152mm) exposure.

1. Hip & Ridge Slate installation requires the slate to be nailed or screwed in place.
  - a) Chalk a straight line by placing one piece of hip at the eave and one near the peak, hold the chalk line at the edge of the slate on the top and bottom pieces. This will help keep the hip straight in the event of a crooked hip.
  - b) Cover heads of fasteners with a butyl-based adhesive sealant compatible with the roof slate in any case of exposure.
  - c) Preformed Ridge Slates require 6" (152mm) exposure and require 2" (51mm) length fasteners (3" (76mm) when using vent ridge).
  - d) Fastener deck penetration must be a minimum of 3/4" (19mm).
  - e) Ridge end closure can be effected by cutting a triangular section from a slate and nailing to the ridge batten, or in the case of a boarded roof, to a timber fillet.

**Hip Installation on a Boarded Roof**

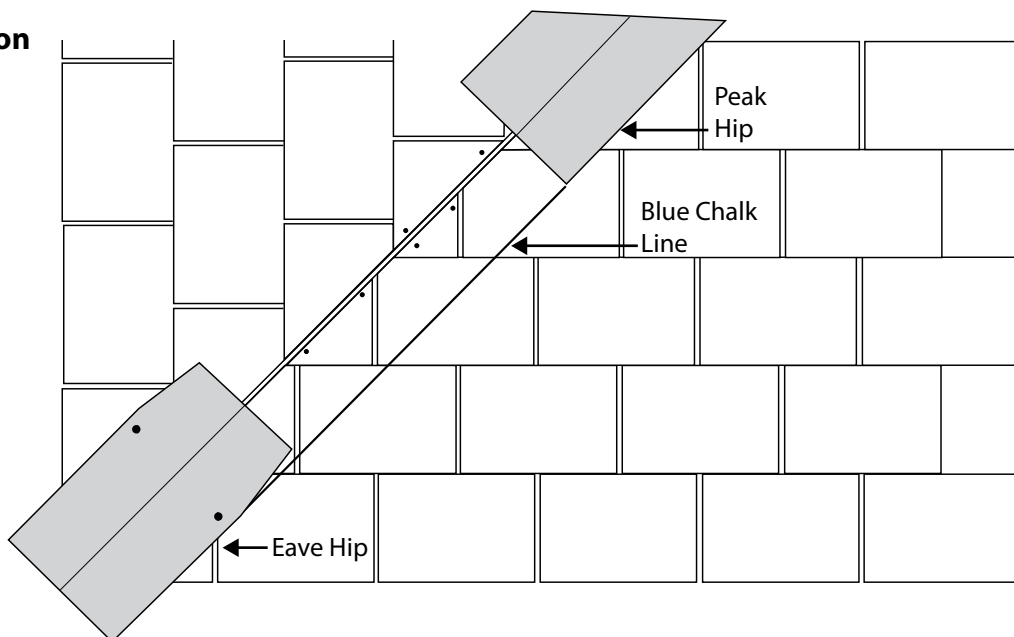

**Hip & Ridge Detail on a Felt & Batten Roof**

Felt & batten roofs need the addition of extra tiling battens to secure the hip tiles.

**Hip Installation on a Battened Roof – Batten Layout**

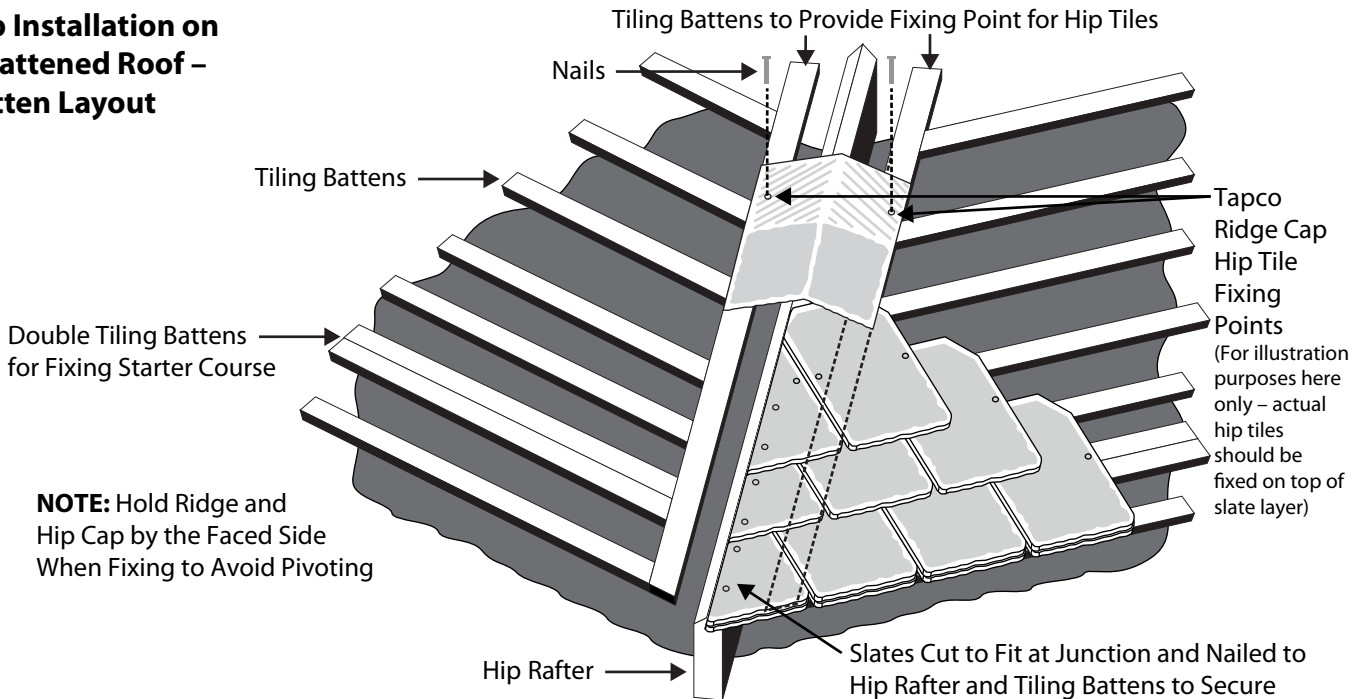

1. Cover the length of the hip with 24" (600mm) underlay from eave to ridge, overlapping the standard underlay on either side of the hip.
2. Position a hip tile in situ and mark the nailing points at the top and bottom of the hip.
3. Using these marks, secure a length of tiling batten either side of the hip to provide a fixing point for the hip tiles.
4. The slating battens should be fitted flush to these hip battens.
5. Cut slates to fit at junction.
6. Affix hip tiles using a minimum of 2" (51mm) nails or screws.
7. Finish at the eaves with a cut-to-size-and-shape TapcoSlate Classic hip tile.

**Hip Installation on a Battened Roof – Tile Layout**

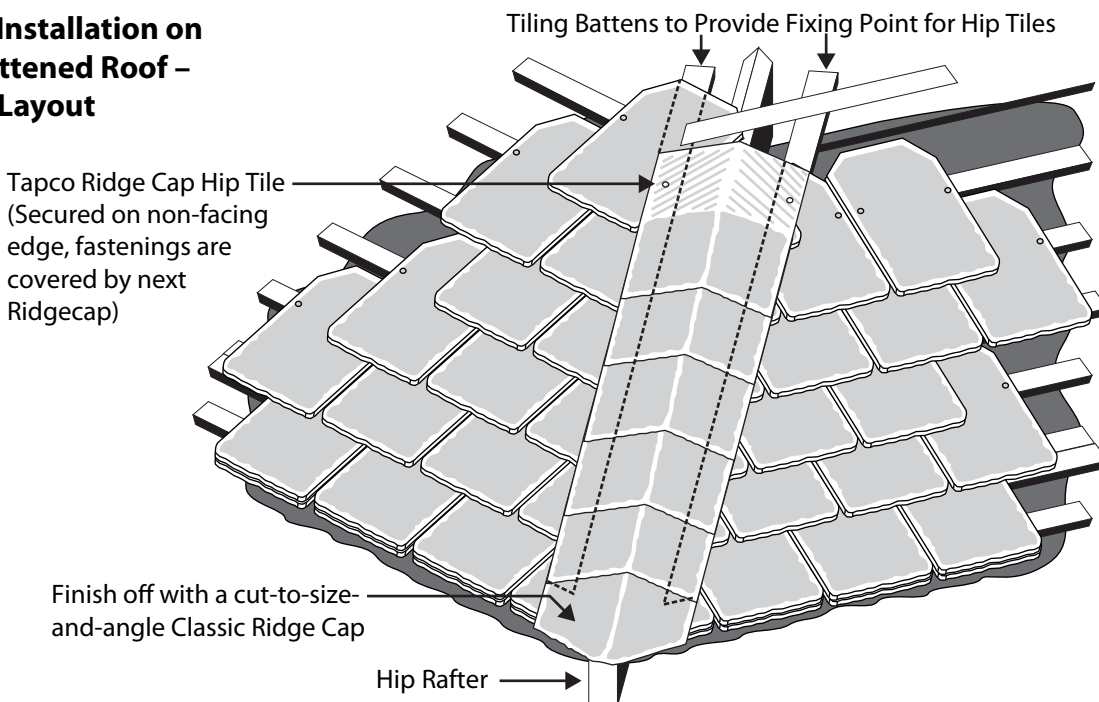

## – Warm & Cold Roof Structures –

### Warm Roof Installation

When installing TapcoSlate Classic onto either battens or directly onto OSB a **vapour impermeable (type HR)** roof membrane/underlay should be used. Insulation should follow the line of rafters, with a 50mm deep void between the top of the insulation and the underside of the underlay/OSB. This void to be ventilated in accordance with BS 5250. An air and vapour control barrier membrane to the warm side of the insulation must also be installed, we recommend the *Protect VC Foil Ultra* – low emissivity air and vapour control layer product.

Insulation (usually PIR) to follow the line of the rafters.

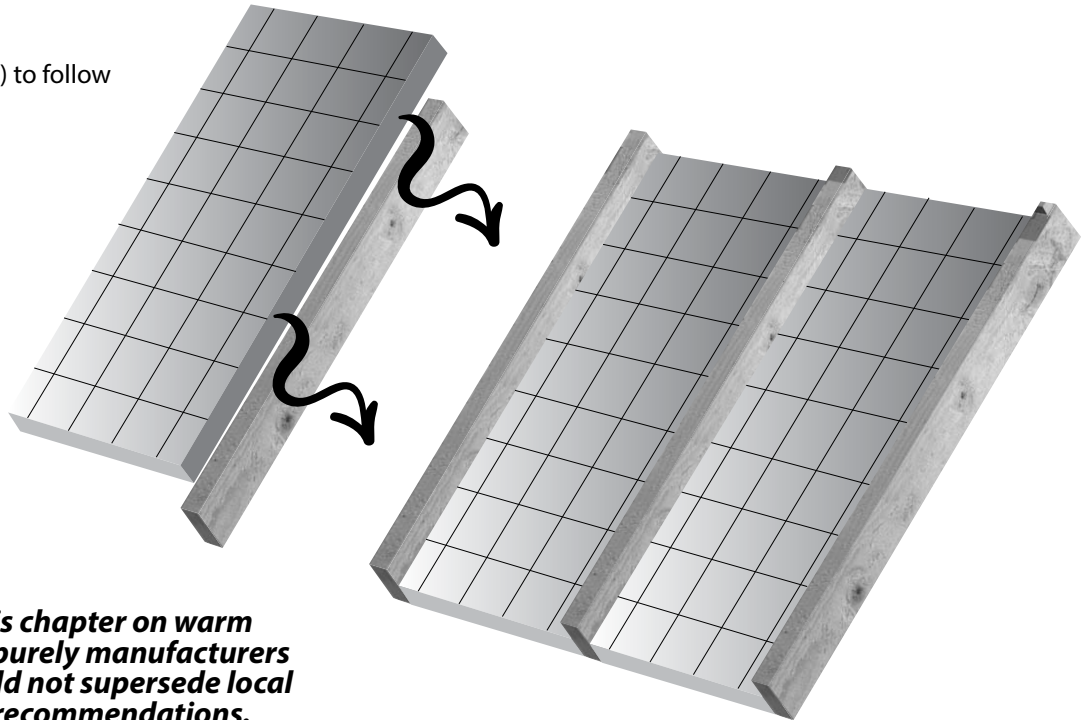

***Please note that this chapter on warm roof installation is purely manufacturers guidance and should not supersede local building authority recommendations.***

A **50mm** void between the insulation and the underside of the underlay/OSB should be maintained (a **25mm minimum** void at the **drape** of the underlay if fitting to felt & battens), ventilated at low- and high-level in accordance with BS 5250.

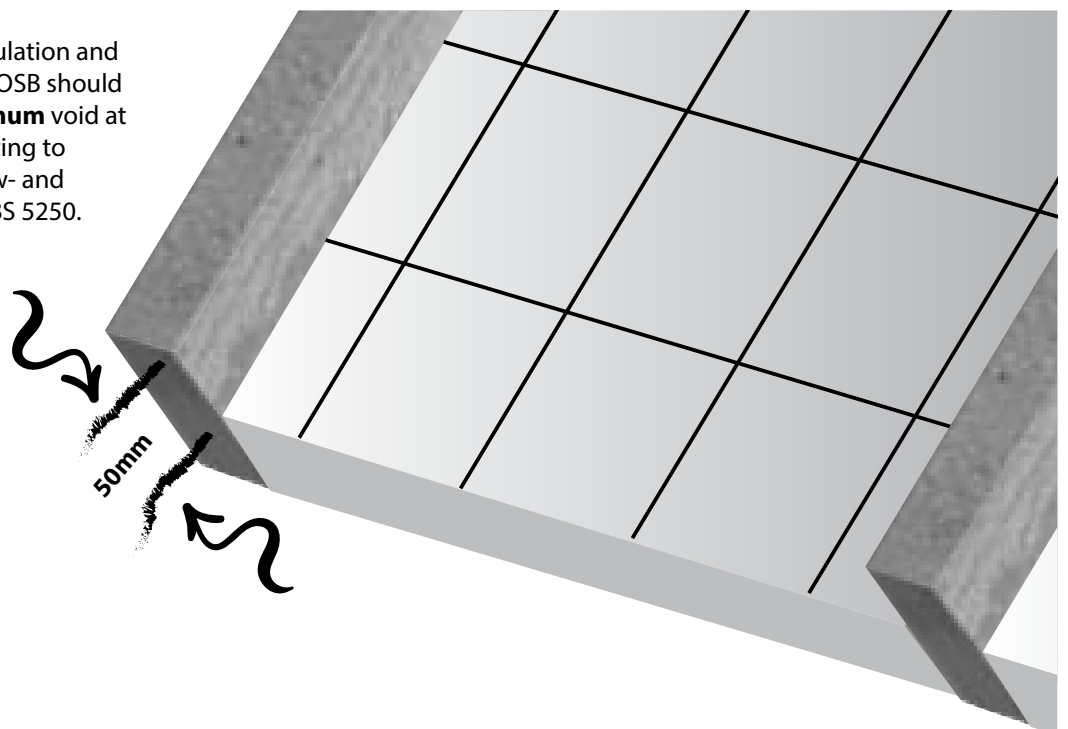

A **Vapour Impermeable (Non-Breathable)** roofing membrane/ underlay should be used. This stops water vapour from forming on the underside of the slates and so can be removed by the ventilated airflow.

On both **Felt & Batten** applications

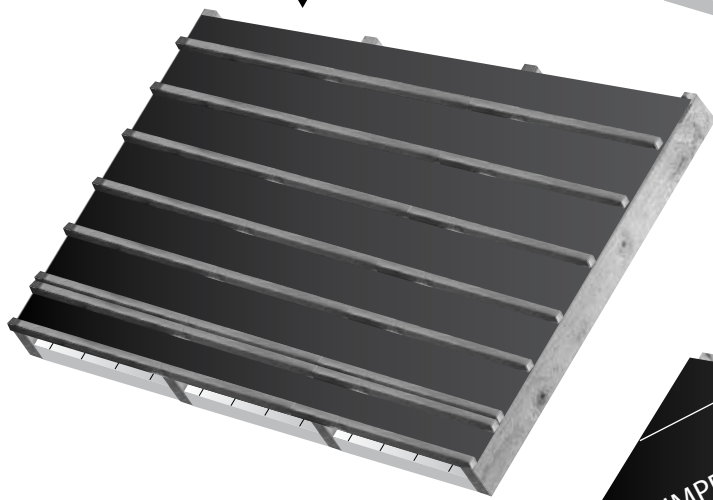
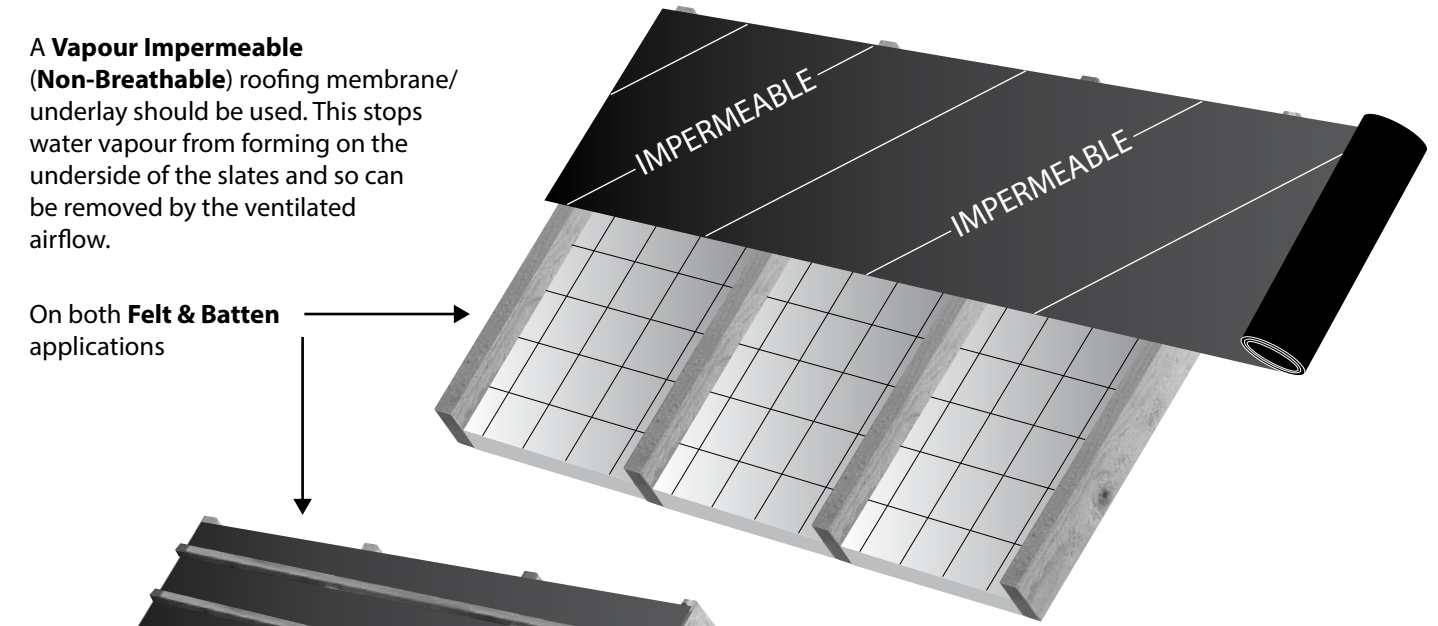

**NOTE: 18mm thick OSB or Ply to be Used on Fully-boarded Structures to Avoid Fixing Penetration to the Underside of the Board**

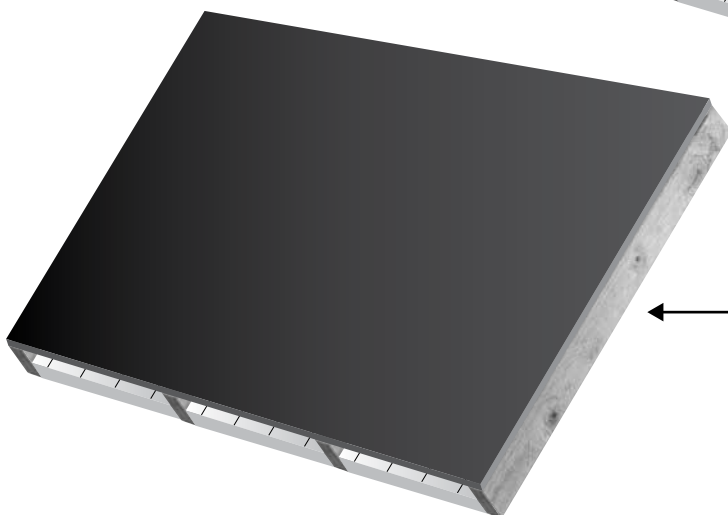
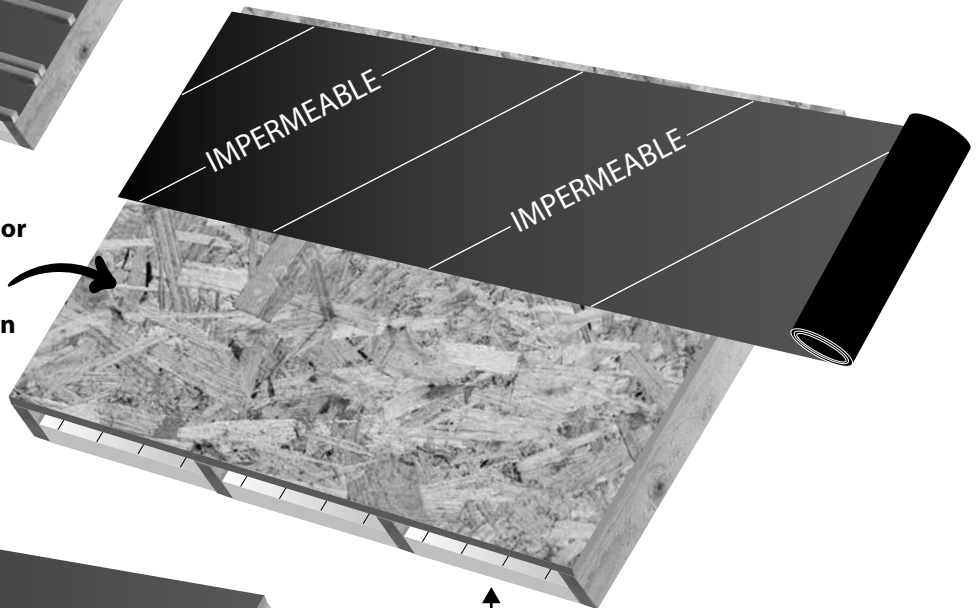

And **Fully-boarded** applications.

TapcoSlate Classic can then be fitted **directly** to board or battens if using an **impermeable** roofing membrane.

Use the pre-formed fixing holes, spacers at each side of the slates and slate exposure guides for layout in broken-bond. Remember to use a starter or eaves course to begin slate courses.

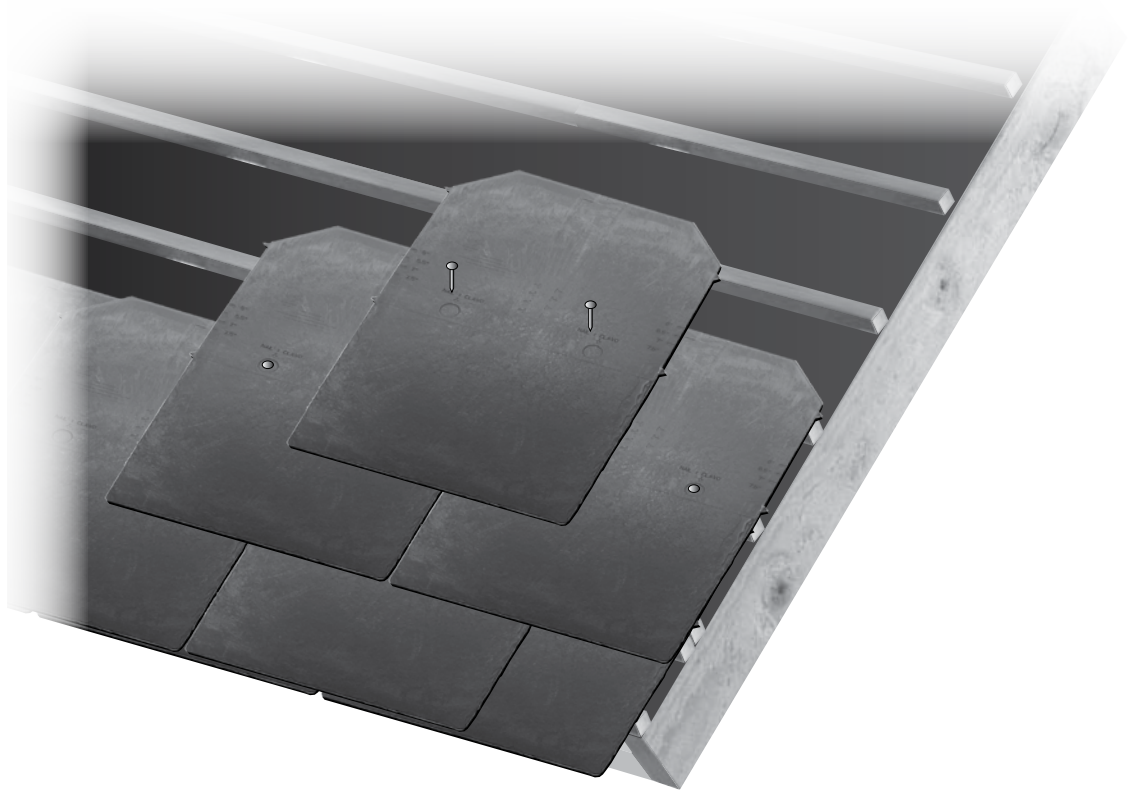

An **Air & Vapour Control Barrier** membrane to the warm side of the insulation (underneath the ceiling plasterboard) **must** be installed. This helps to prevent water vapour from even reaching the roof structure.

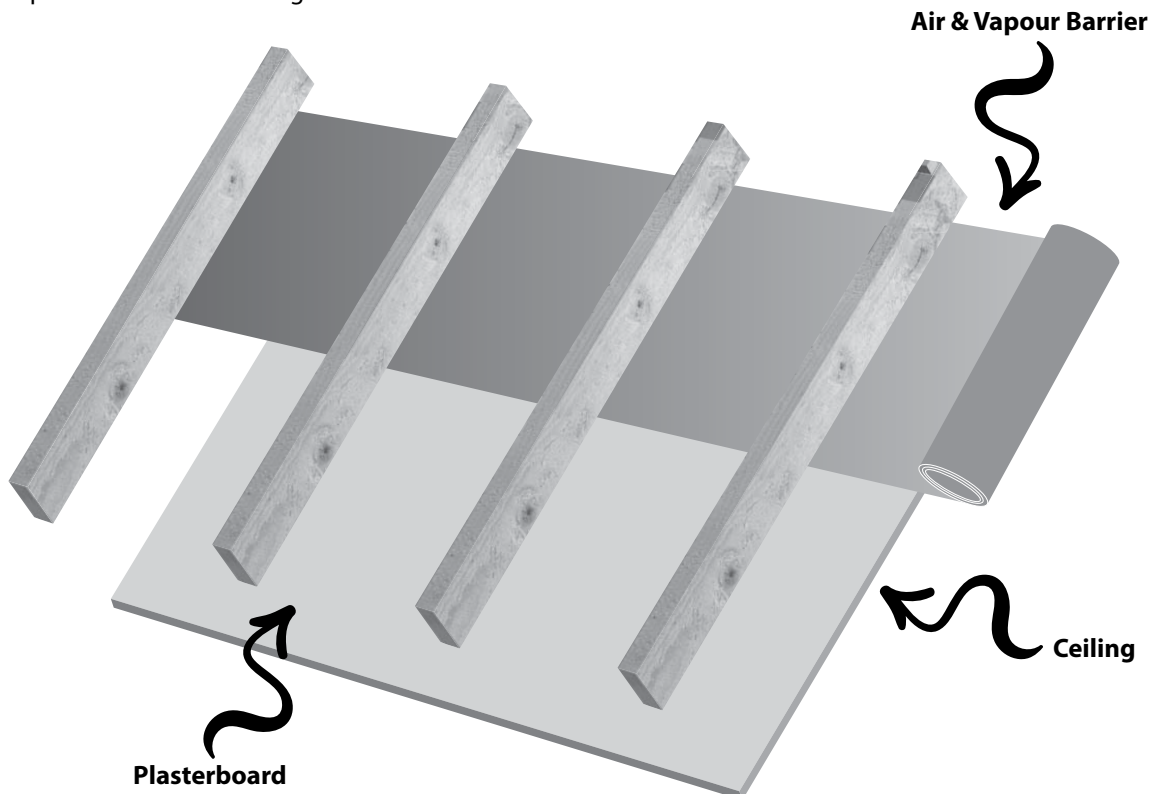



## Cold Roof Installation

When installing TapcoSlate Classic onto either battens or OSB a **vapour impermeable (type HR)** roof membrane/underlay should be used. When installing directly onto OSB, ventilation in accordance with BS 5250 to the loft void should be adhered to. Insulation should be installed on the horizontal ceiling below. To further enhance this construction, improving thermal performance of all insulation by reducing convection flow and help to avoid interstitial condensation risk within insulation in accordance with BS 5250, we would recommend installing an air barrier on the warm side of the insulation, a suitable product would be *Protect BarriAir* – an air barrier membrane with some vapour control properties.

**Insulation** should be installed on the horizontal ceiling, typically rolls of rock, glass or mineral fibre.

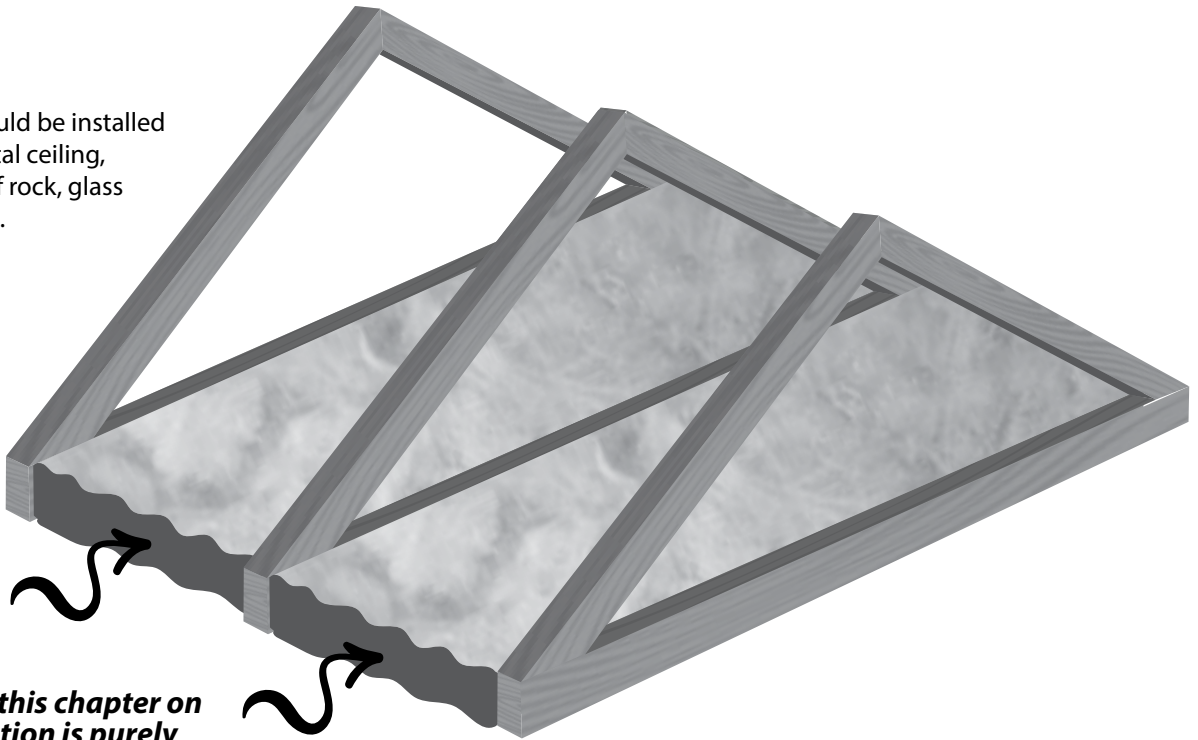

**Please note that this chapter on cold roof installation is purely manufacturers guidance and should not supersede local building authority recommendations.**

**Low-level and High-level ventilation** in accordance with **BS 5250** to the loft void should be adhered to. See the next Section on **ventilation** for guidelines.

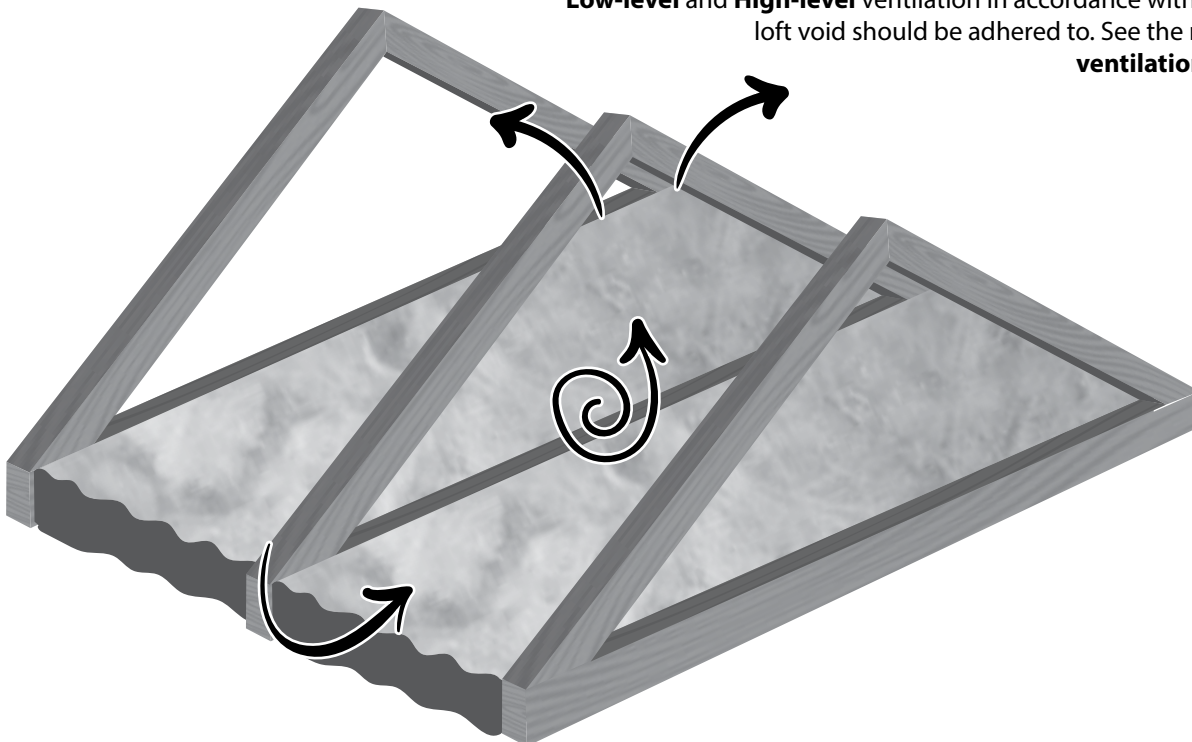

A **Vapour Impermeable (Non-Breathable)** roofing membrane/underlay should be used to stop water vapour from forming on the underside of the slates and will be removed by the ventilated airflow.

On both **Felt & Batten** applications

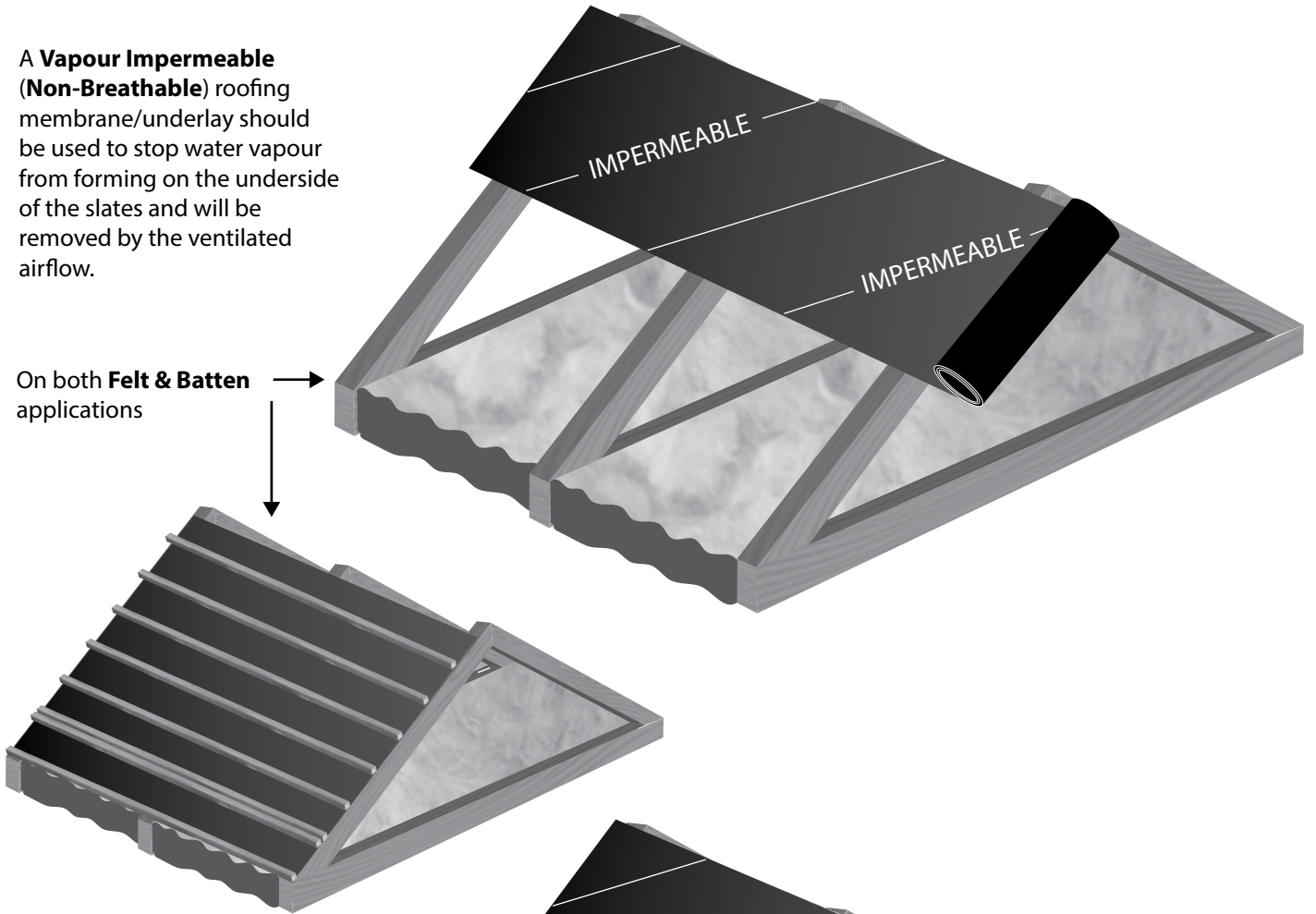

**NOTE: 18mm thick OSB or Ply to be Used on Fully-boarded Structures to Avoid Fixing Penetration to the Underside of the Board**

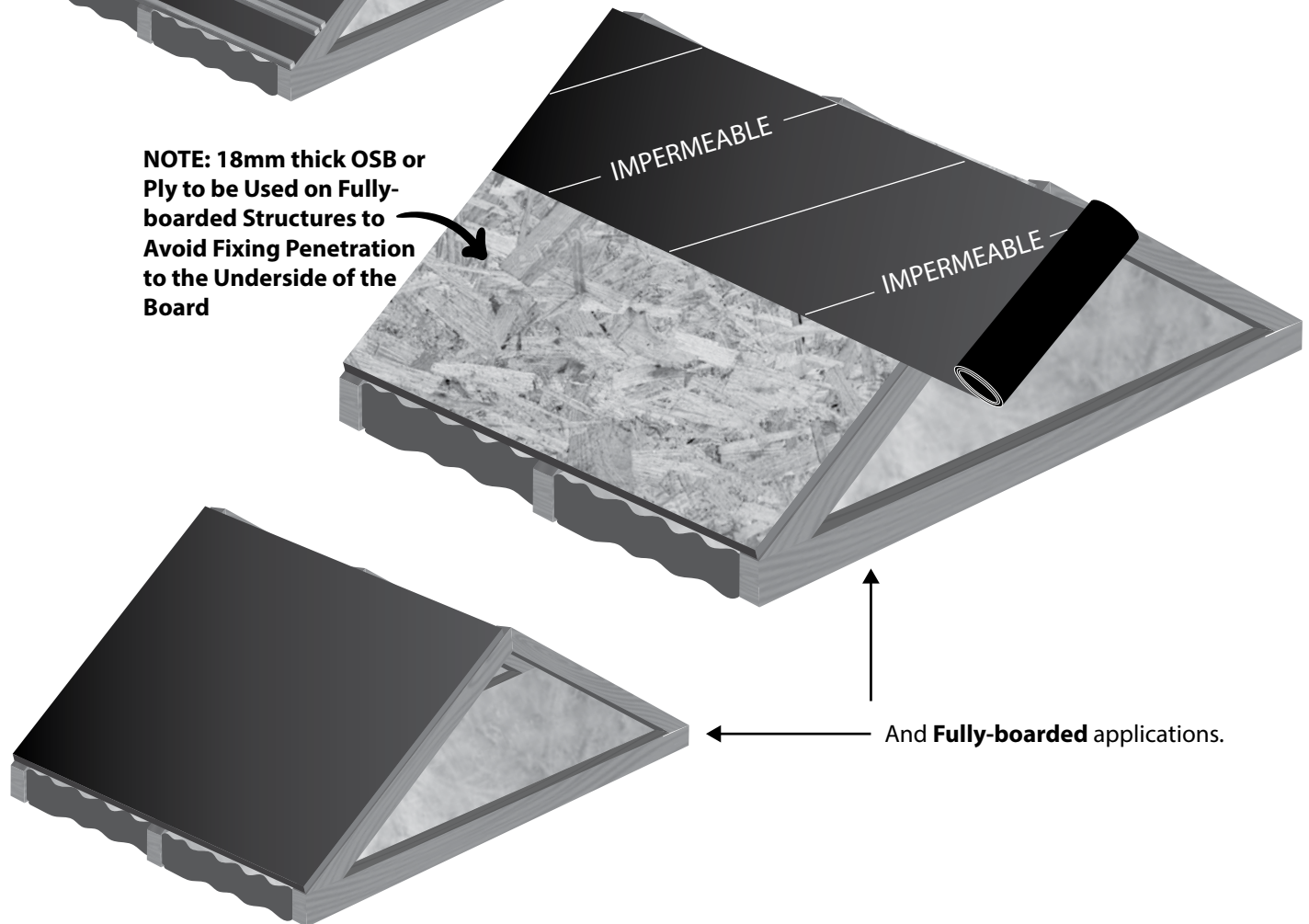

TapcoSlate Classic can then be fitted **directly** to board or battens if using an **impermeable** roofing membrane.

Use the pre-formed fixing holes, spacers at each side of the slates and slate exposure guides for layout in broken-bond. Remember to use a starter or eaves course to begin slate courses.

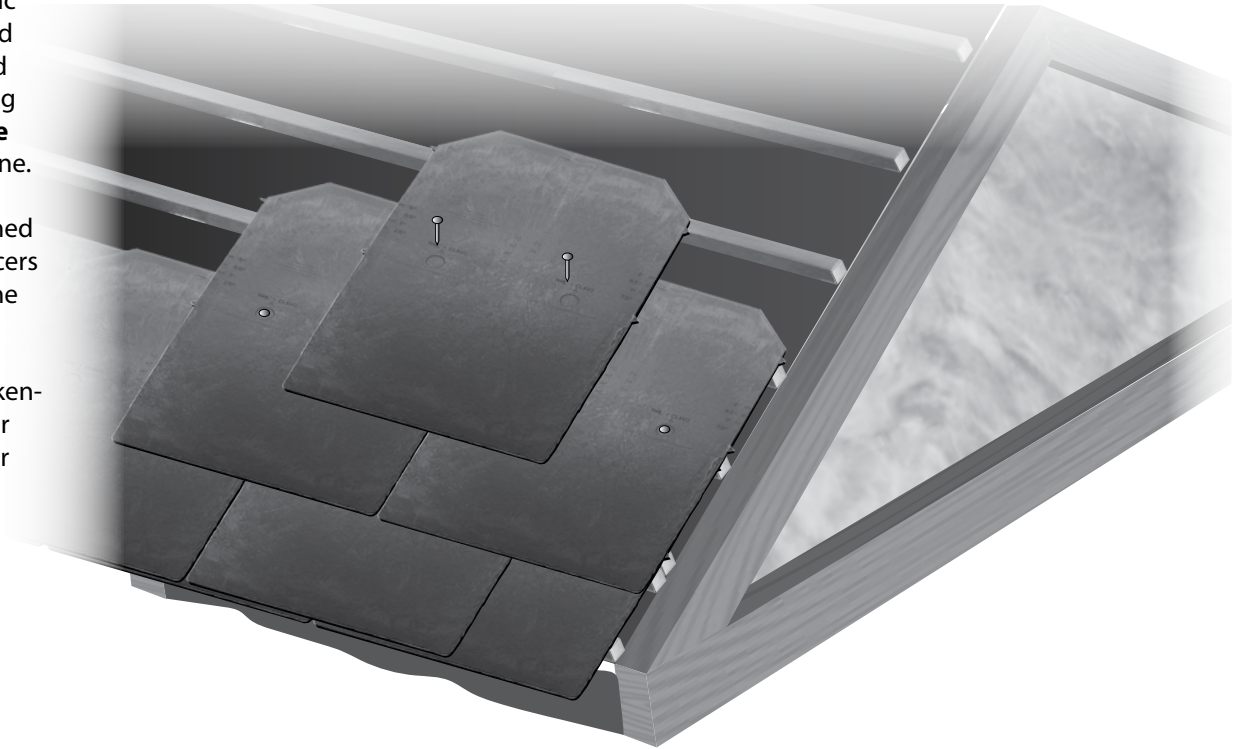

To improve thermal performance of the insulation, an **Air Barrier Membrane** fitted to the **warm side** of the insulation (underneath the ceiling plasterboard) is recommended.

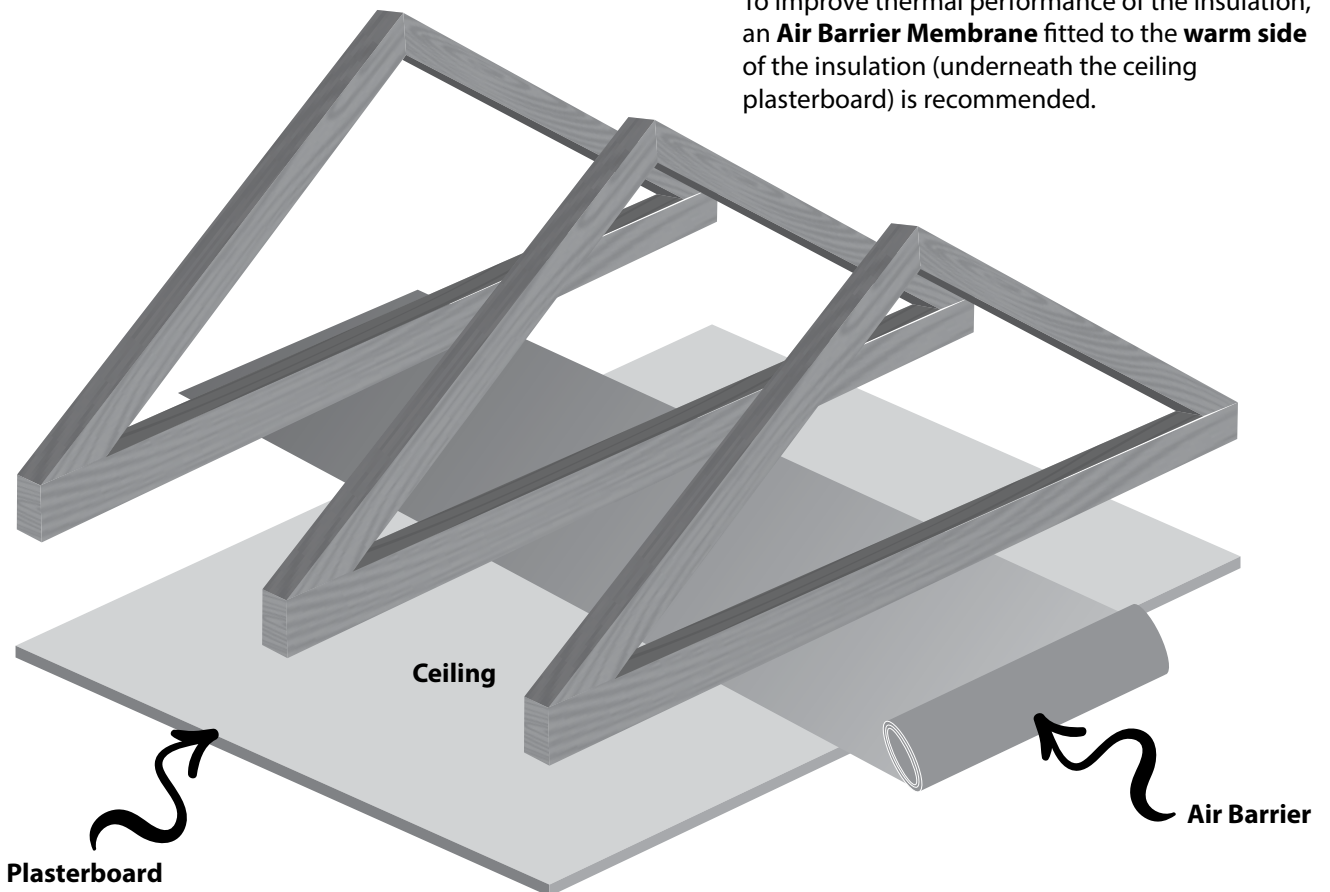

## – Ventilation –

### British Standard (BS) 5250

**BS 5250** stipulates guidelines with regards roofing ventilation and condensation. Its primary concern is to eradicate condensation, which is mainly generated from within the home, from reaching and destroying the roof structure timber. Even when timber is not used in the roof construction, the vapour still needs to be properly extracted to prevent it from affecting other parts of the dwelling place.

As with many other roof coverings, TapcoSlate Classic is classified as an **“Insufficiently Air Open”** product, meaning that water vapour cannot vent to atmosphere directly through the tiles, and so provision must be made to ventilate the roof space to move the water vapour from **inside to outside** the property. Proper ventilation is an **essential** part of modern-day roofing.

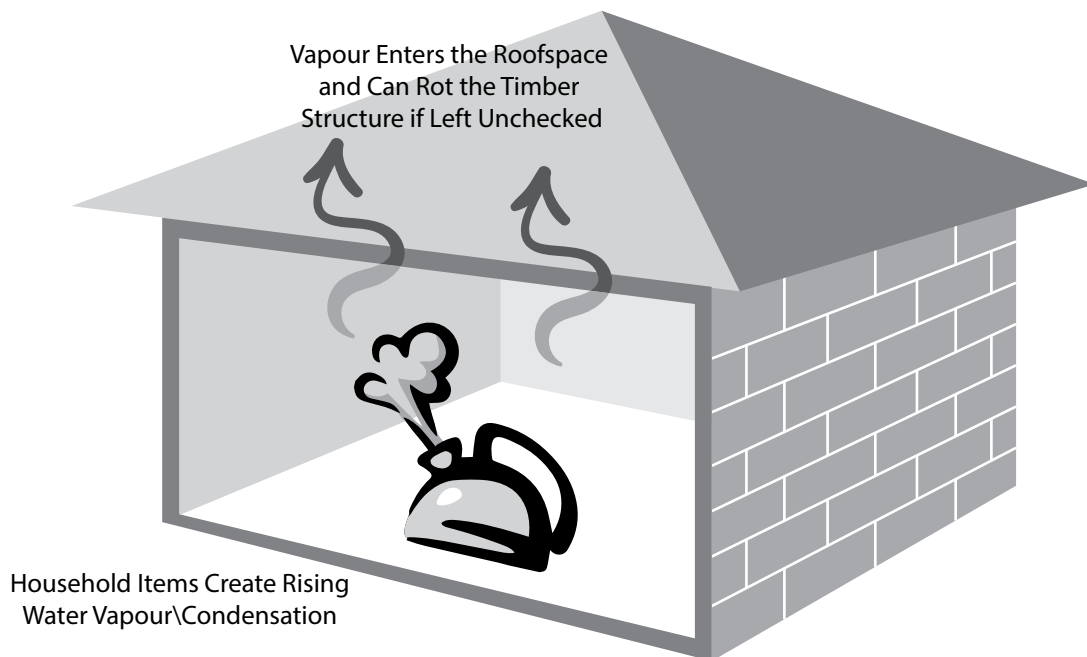

### Standard Roof Ventilation

**BS 5250** requires all roof structures to be **ventilated** at both **low-level** (air moving into the roof), which is typically at the eaves or soffit and at **high-level** (air moving out of the roof), which is typically at the ridge/hip, abutment, or with the use of fixed ventilation units.

Obstructions such as dormers, valleys, roof windows, compartment walls, fire barriers and changes in pitch create **separate voids** below the roof slope. Ventilation openings should be provided to **each void** at high and low level.

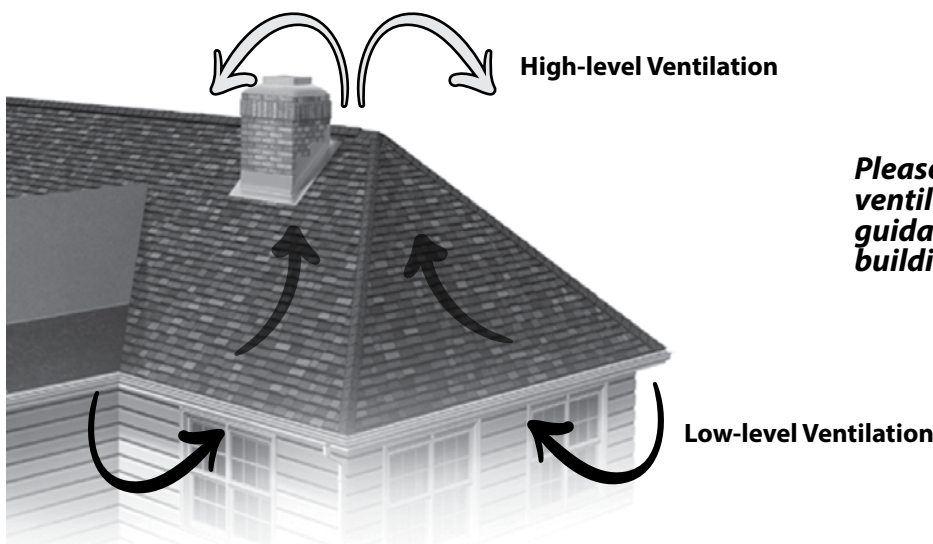

***Please note that this chapter on roof ventilation is purely manufacturers guidance and should not supersede local building authority recommendations.***

## Guidelines for Low-level Roof Ventilation

**Tapco Eaves Ventilation Kits** are recommended for low-level roof ventilation in both warm roof and cold roof construction. On a **warm roof** a 50mm void following the line of the rafters should be maintained and on a **cold roof** the loft space needs to be ventilated. These kits achieve this while keeping debris and insects from blocking the airflow. The **TEVK10** and **TEVK25** Eaves Ventilation Kits install continuously along the eaves and provide ventilation openings of **10,000mm<sup>2</sup>/m** (cold roof) and **25,000mm<sup>2</sup>/m** (warm roof) respectively. This kit consists of 10mm or 25mm over-fascia vents and eaves skirts in a 6-linear-metre pack. The **TEVK10** (10mm kit) also consists of a 300mm x 6m **Rafter Ventilation Roll** since most cold roof installations are felt & batten construction. Note that the **TEVK25** (25mm kit) does not include a Rafter Ventilation Roll, but this will be required to purchase separately if using felt & batten construction.

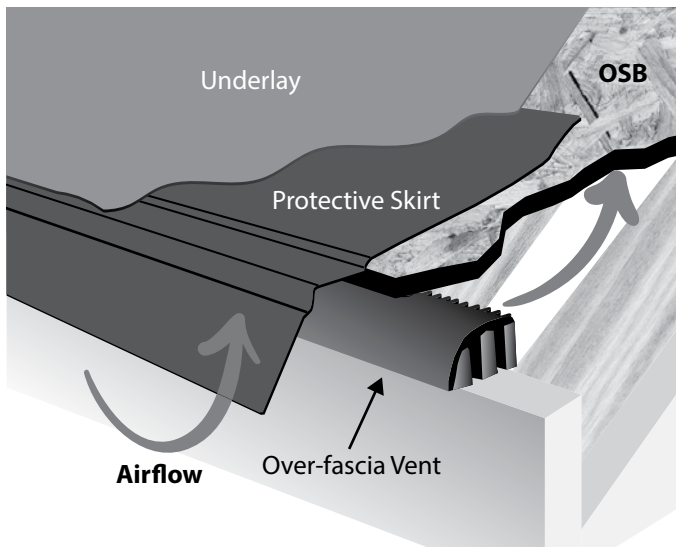

### Fully-Boarded Roof

The **over-fascia vent** is fixed onto the fascia board and sits underneath the OSB or ply. The **protective skirt** covers the vent and roofing membrane is then laid on top of the skirt and the rest of the roof. Airflow comes in from the underneath of the vent and flows up the roof underneath the OSB/ply.



**TVK25 Eaves Ventilation Kit (Warm Roof Application)**

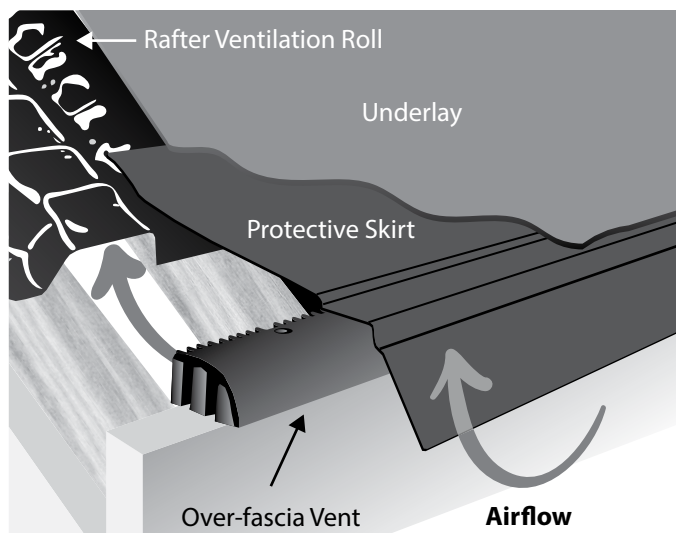

### Felt & Batten Roof

The **over-fascia vent** is fixed onto the fascia board and the **protective skirt** fits on top to protect the vent. For felt & batten installations we advise fitting a **Rafter Ventilation Roll** along the span. The roofing membrane sits on top and battens can then be fixed.



**Rafter Ventilation Roll (Felt & Batten Roof Construction)**



**TVK10 Eaves Ventilation Kit (Cold Roof Application)**

## Guidelines for High-level Roof Ventilation

**High-level ventilation** is needed for the low-level airflow to exit and vent water vapour to atmosphere. Cross-flow ventilation (low-level to low-level) has been shown to be inadequate as standard air pressure is too low to adequately vent water vapour in this way. The use of the **RidgeMaster Plus** ridge ventilation system and/or **HipMaster** hip ventilation system is recommended in both warm roof and cold roof construction when installing TapcoSlate Classic. The **Tapco Abutment Ventilator** is again recommended in both scenarios for roofing abutments (such as lean-to roofs).

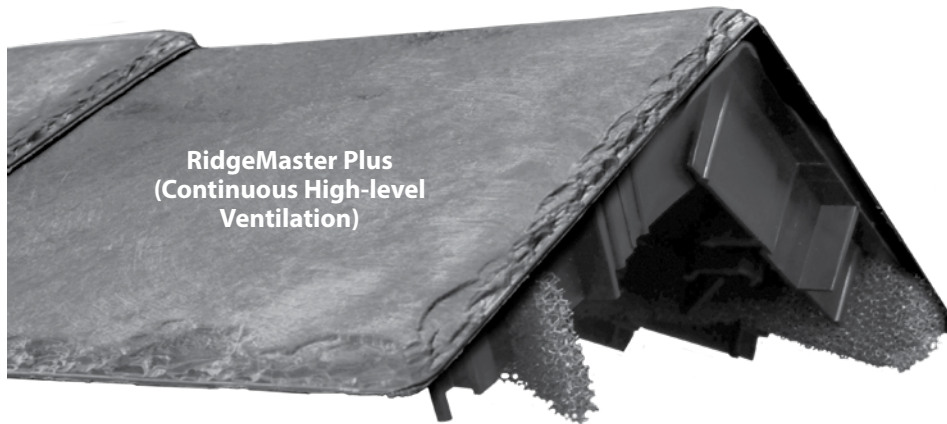

### RidgeMaster Plus & HipMaster

The **RidgeMaster Plus** and **HipMaster** ventilation systems are manufactured specifically to fit underneath our **TapcoSlate Classic Ridge & Hip Caps** for continuous ridge and/or hip ventilation. These units provide **10,000mm<sup>2</sup>/m** high-level airflow and are easily fixed in place by nailing or screwing directly through the markers on our ridge & hip caps. Each unit covers 1.2 linear metres, is unobtrusive when fixed and contains baffles to prevent debris and insects.



### Tapco Abutment Ventilator

The **Tapco Abutment Ventilator** provides unobtrusive **5000mm<sup>2</sup>/m** high-level ventilation in conjunction with lead roll details on slate roofs. It is particularly useful in top edge abutment details where there is limited vertical clearance. The ventilator provides full compliance with **BS 5250 Control of Condensation in Buildings**, the primary means to comply with **Building Regulations** in the UK as well as providing driving rain and large insect resistance.

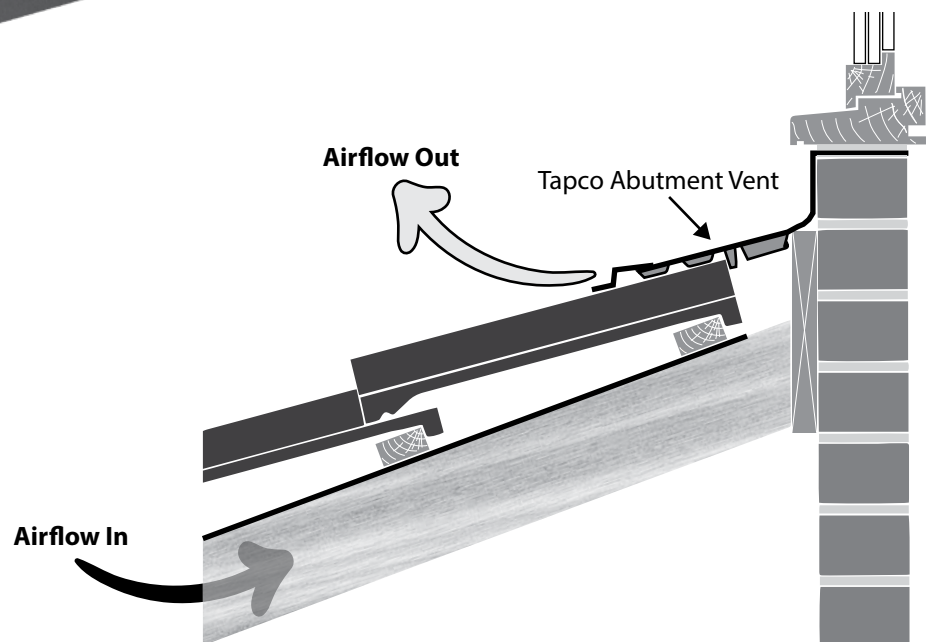

## Tapco Inline Ventilator

**Tapco Inline Slate Ventilators** have been designed to provide an aesthetic and unobtrusive solution to roof space ventilation. They can be used at low or high level where the roof construction does not allow eaves or ridge ventilators to be used, or where complex roof shapes do not allow effective cross ventilation. **Inline Slate Ventilators** are suitable for roof pitches from 20° to 90°, and provide **10,000mm<sup>2</sup>/m** airflow.

### Warm Roof

High-level ventilation to the equivalent of **5000mm<sup>2</sup>/m** is required for warm roof structures. This can be achieved by installing inline slate ventilators spaced at 2m centres. There must be provision for sideways movement of air in this scenario (the ventilation terminals may require additional finishing to ensure the airpath is not restricted by the insulation below).

### Cold Roof

**Inline** or **Cowl Slate Ventilators**, providing **10,000mm<sup>2</sup>/m** free area and spaced at 1m centres, or alternatively **Cowl Vents** providing **20,000mm<sup>2</sup>/m** (20k) free area spaced at 2 metre centres, can be used as high-level ventilation. For roof pitches greater than 35 degrees or spans (wallplate-to-wallplate) greater than 10m, providing high-level ventilation to the equivalent of **5,000mm<sup>2</sup>/m** is required. This can be achieved by installing inline or cowl slate ventilators spaced at 2m centres.

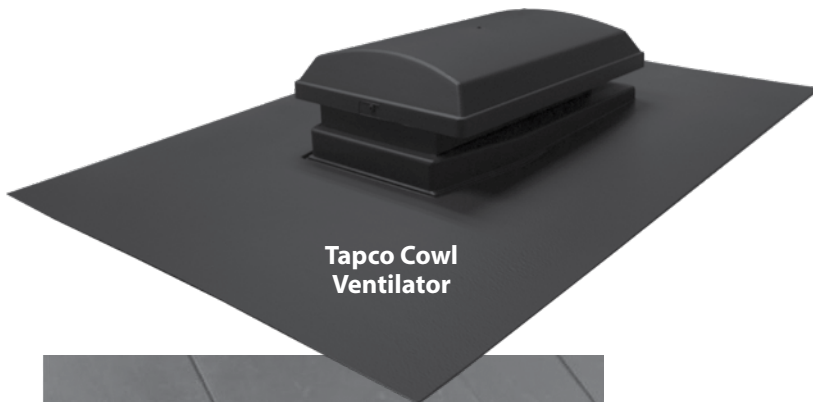
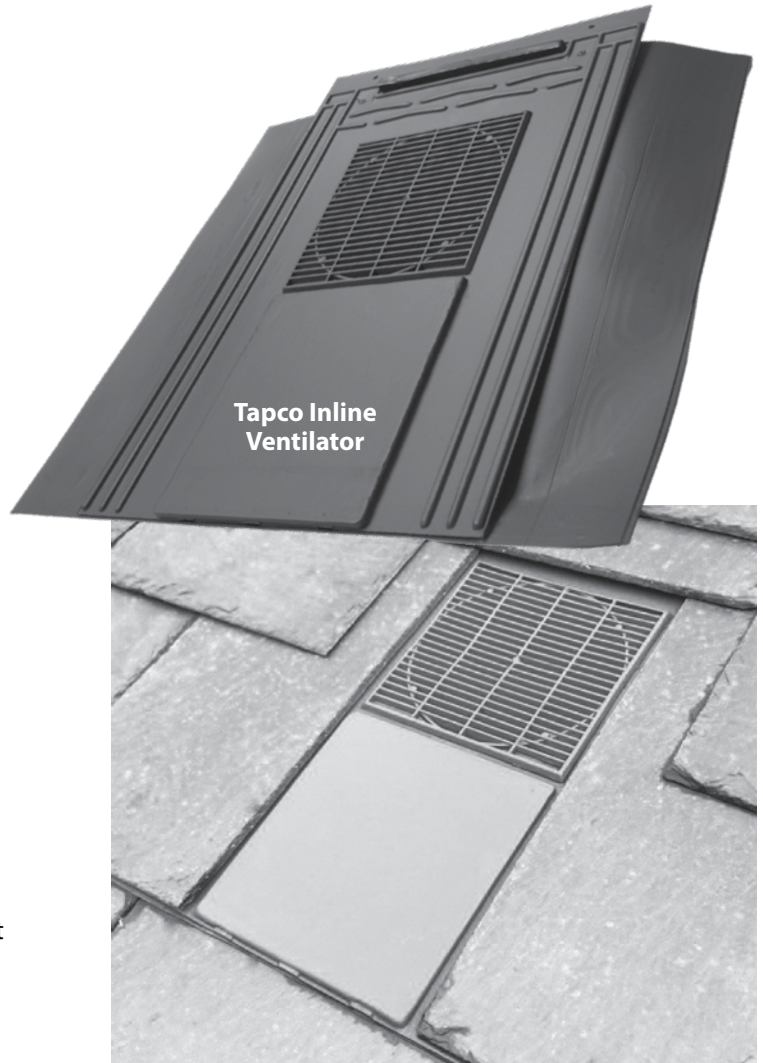

Tapco Cowl Ventilator

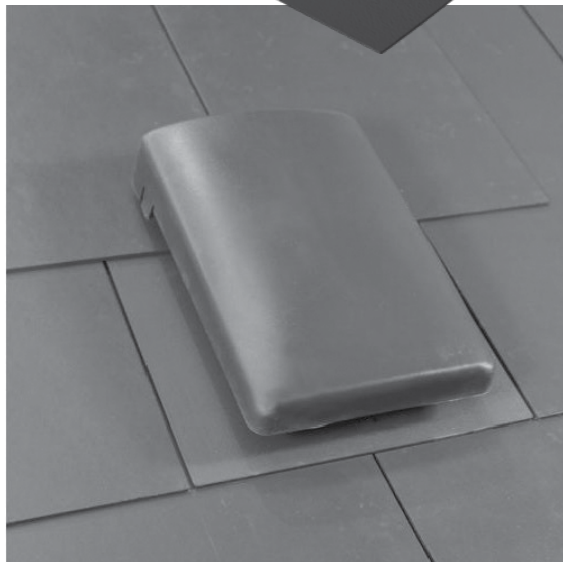

## Tapco Cowl Ventilator

**Tapco Cowl/Soaker-style Slate Ventilators** are designed to ventilate through the roof slope and form an integral part of a slate or tile roof covering. They can be used at low or high level where the roof construction does not allow eaves or ridge ventilators to be used, or where complex roof shapes do not allow effective cross ventilation. **Cowl Slate Ventilators** are suitable for roof pitches from 15° to 90°. They are available in **10,000mm<sup>2</sup>/m** and **20,000mm<sup>2</sup>/m** airflow units.

### Pipe Adapters

**Pipe Adapters** are also available to allow **Inline** or **Cowl Ventilators** to be used in conjunction with a standard round vent pipe. This converts the vent to a soil pipe fitting and/or mechanical extract terminal.



Inline Vent Pipe Adapter

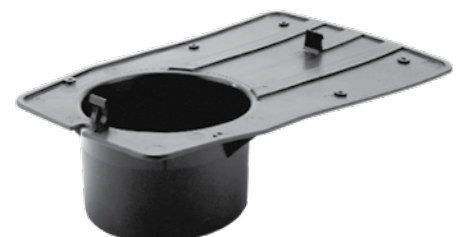

Cowl Vent Pipe Adapter

# - Special Instructions -

## Installation in Exceptionally High Wind Areas

TapcoSlates are tested for resistance to wind driven rain/wind uplift, as follows:

- Miami Dade TAS-100: (110 mph wind-driven rain). No water infiltration through sheathing. No slate cracked, split or lifted.

There are certain areas, particularly on west-facing coasts and exposed islands, where wind speeds can exceed this level, and in order to reduce the risk of uplift, the following installation instructions should be followed:

1. TapcoSlates should be fixed directly to a solid substrate, such as sarking board, OSB or weather-grade ply.
2. The maximum overlap – slates set at the 6" (152mm) gauge – should be used.
3. Standard copper roofing rivets should be installed: a hole is drilled in the overlapping or top slate, and a rivet is slid up between the gap in the two bottom slates (see diagram below). The rivet should be put in a position where it can be inserted through the hole and bent over. After a length of time the rivets will naturally blend in with the slate.

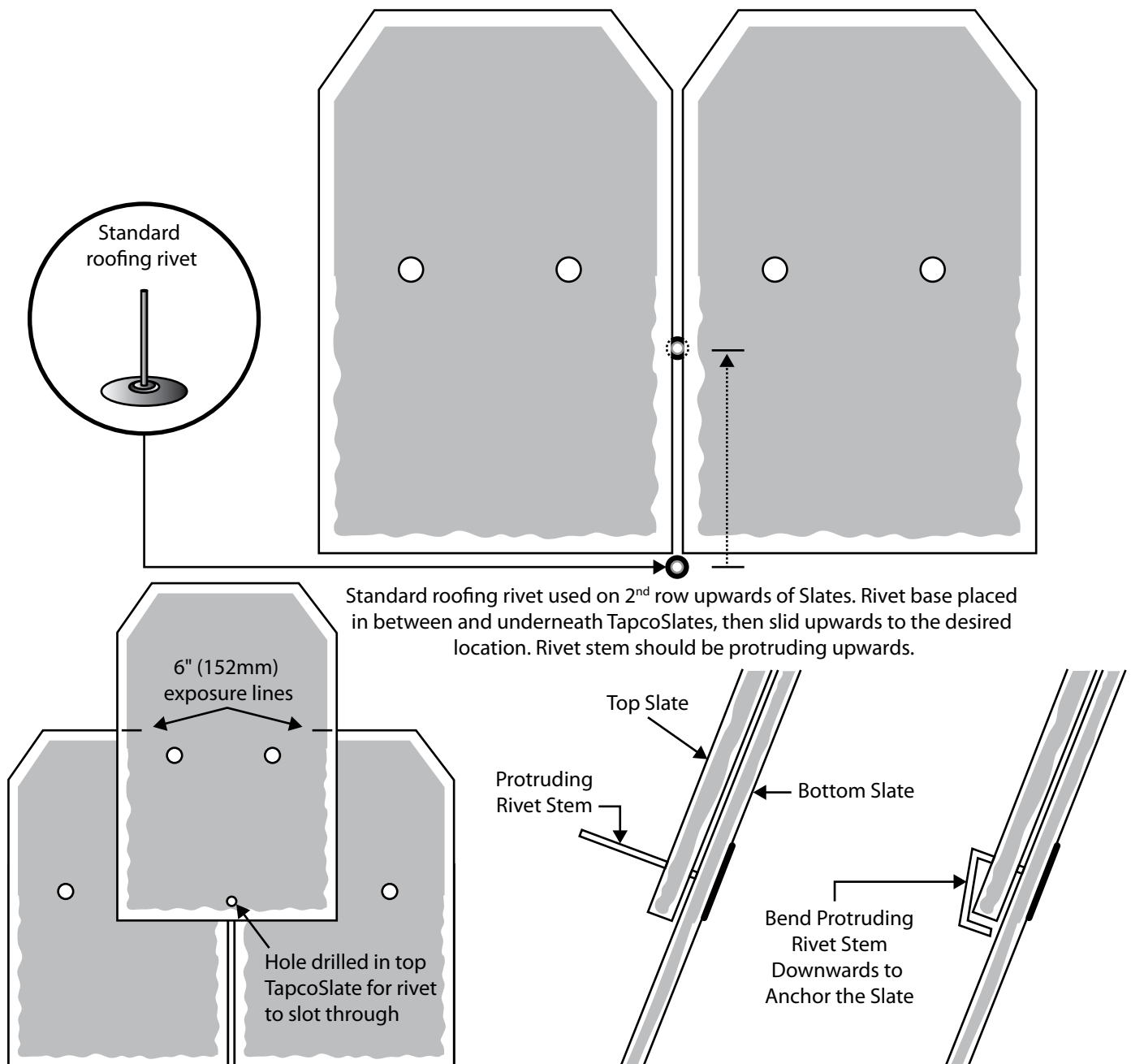



## Turret Installation

Turrets and cones need custom cut slates which change depending on the radius and pitch. They can be quite difficult to install; time and care must be taken during installation.

1. Determine the taper by chalking lines originating at the peak, extending to eave spaced 11.5" to 5/8" (292mm to 16mm) apart for Classic (the width of one slate).
2. Place the slate at the eave between the 2 lines, this will give you the proper taper for the first course.
3. Mark up from the top of your first slate your exposure. Repeat until you reach the top of the turret.
4. Each course will have a different taper as the pieces get smaller towards the top. You can now place a slate to each mark and determine the taper per course.
5. Be sure to pay attention to the size of the slates, If the slates get too small it may be necessary to use a larger slate and re-chalk lines at some point.
6. Make sure measurements are periodically taken from eave and peak to ensure straight courses.

### Precautions

Roof slates may be slippery when wet or covered with frost. Fall protection equipment is required when working on a roof deck. The contractor may consider the use of toe boards. TapcoSlate roof slates should be stored in temperatures above 7°C and the ambient temperature of the product must be at a minimum of 7°C during installation in order to avoid webbing and/or cracking of the roof slates.

Do not leave debris under the roof slates while installing that will prevent the design of the roof slate from overlapping on the course below, thus allowing the potential for moisture build up from wind-driven rain and/or ice dams.

Use accessory products with a lifecycle as equally long-term as the roof slates.

Technical Bulletins should be reviewed and considered prior to the start of any project.

### Turret Installation

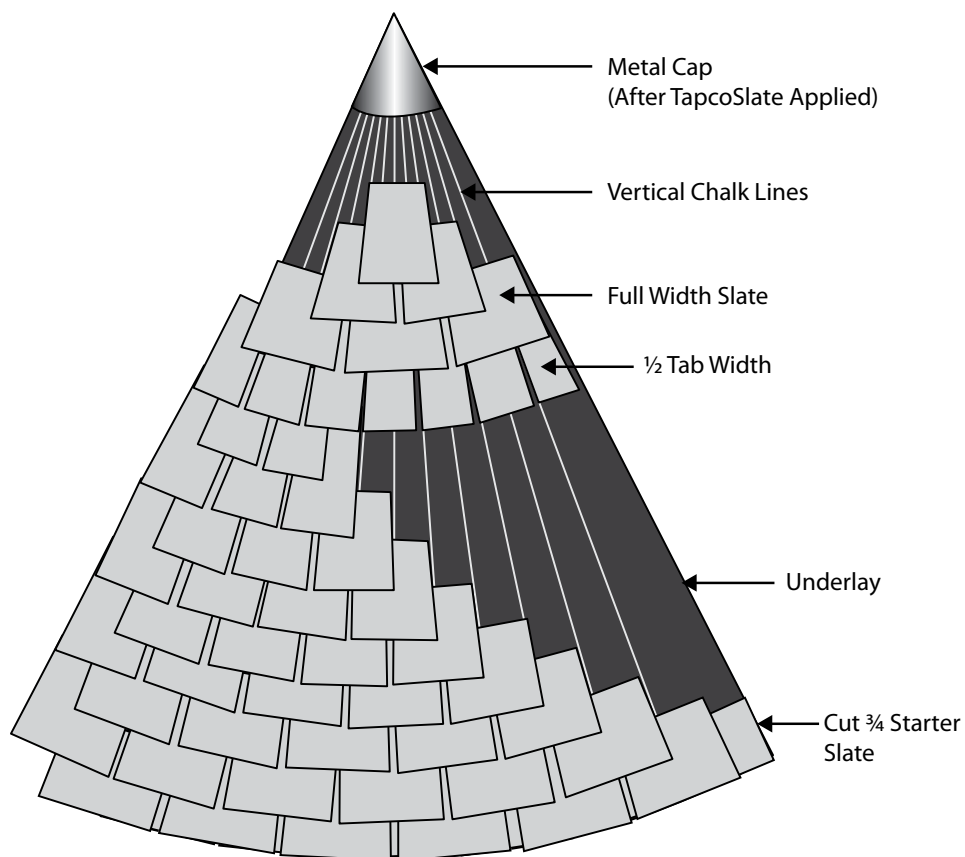

## Removing/Re-fitting TapcoSlates

The removal and re-installation of individual slates can be achieved quite easily when the slates have been nailed into place, but more difficult if screws have been used to install the product.

### Removal/Re-fitting: Nailed Install

#### Tools

The correct tools should be used for the removal and re-installation of the slates, we recommend a Vaughan SuperBar and/or a Roof Snake, a hammer and nails and a block of wood.



On both the SuperBar and the Roof Snake, the forked end is used to slip under the tile above the one being removed to lift up the nail and remove – the SuperBar's eye hole can be used to better effect to accomplish the nail removal as it will keep the tile above as flat as possible and avoid any distortion.

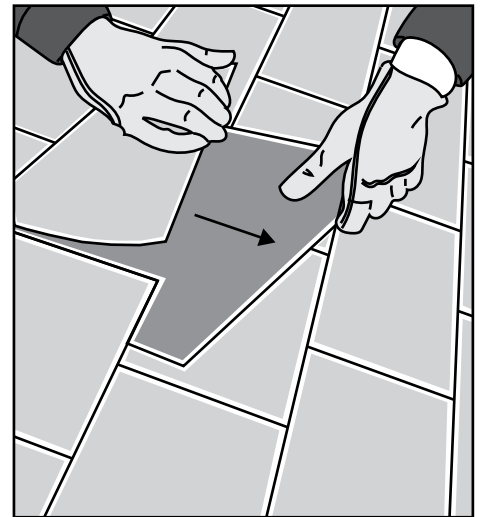
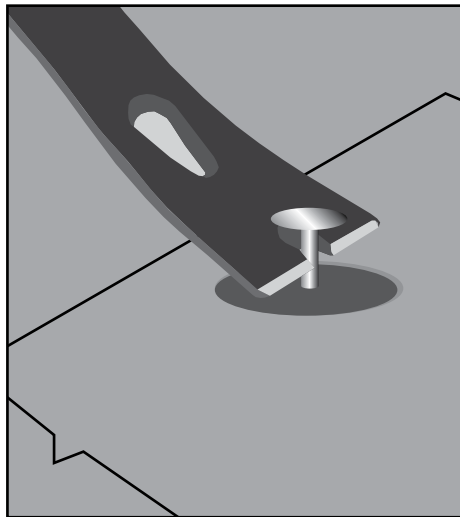
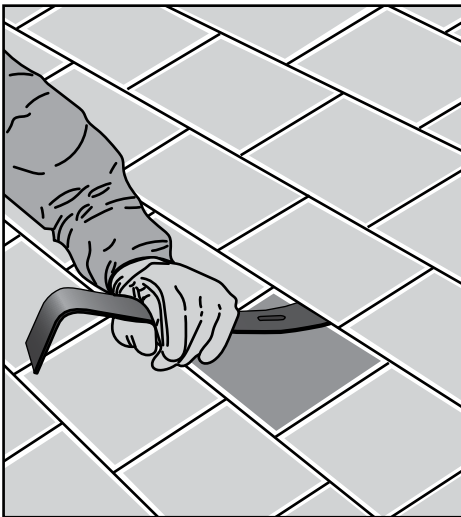

To replace the slate, it is handy to use a Roof Snake as it allows the installer to insert a new nail into the tool and use a hammer on the tool neck or a block of wood (which helps protect the slate surface) to drive the nail home. Alternatively, if not using a Roof Snake a second block of wood can be used in a similar way.

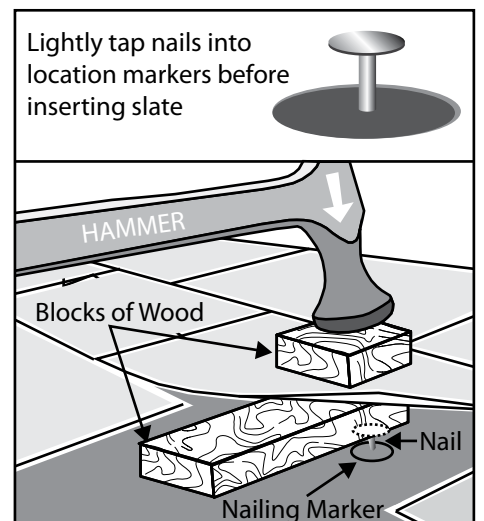
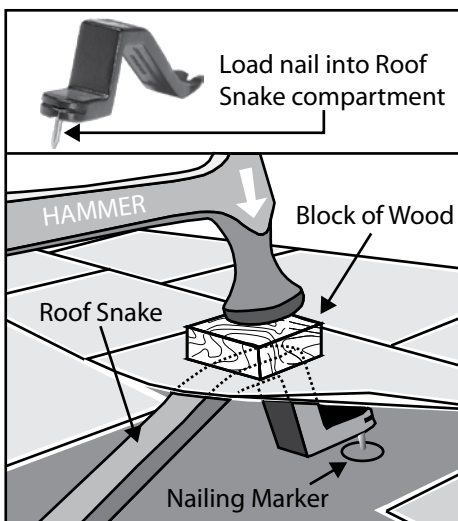
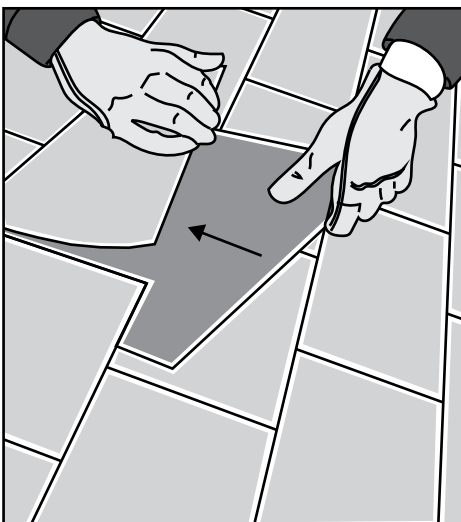

**Removal/Re-fitting: Screwed Install**

*Tools*

Hand screwdriver and/or powered screwdriver/drill.

To remove a TapcoSlate that has been fixed by screws, the only way to achieve this is to remove a certain amount of other slates by unscrewing from the top of the roof downwards to the affected slate that you wish to remove. This will also involve removing ridge caps in the affected area unless the slate screws are easily accessible by lifting the caps with a pry bar. Prior to removing the slates, it would be best to label/number them in order of removal using masking tape and a pen/pencil. Always carefully and systematically stack the slates in order of removal so that they can be placed back in the same place. Please note that over time there will be a certain amount of uniform weathering on the roof slates, and so a brand-new slate will never completely match the older ones at first until this too has weathered-in over a period of time.

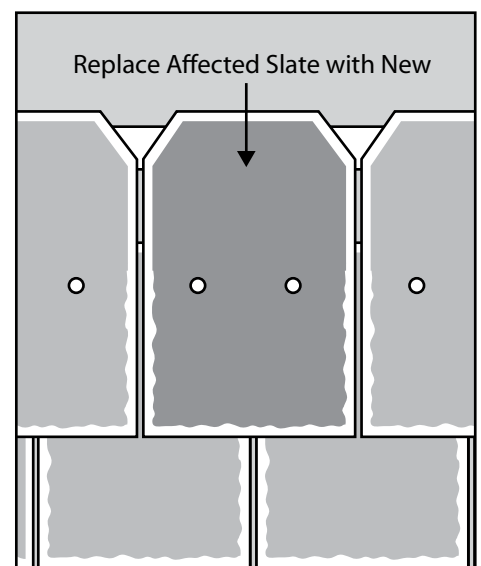
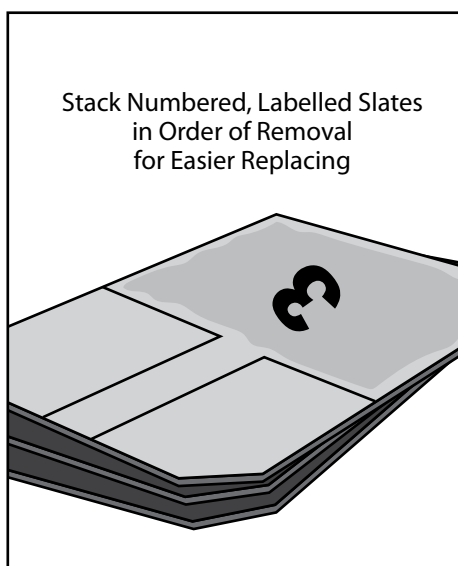
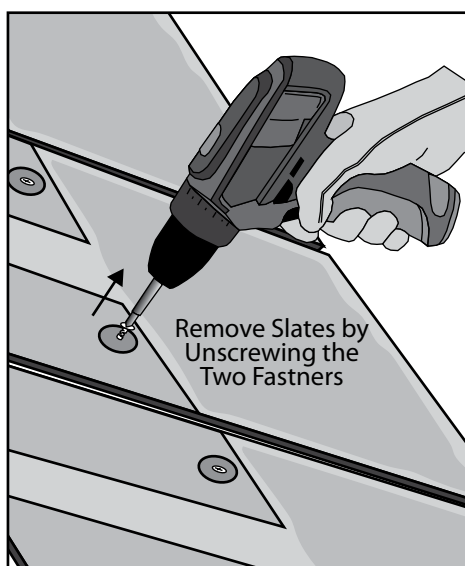
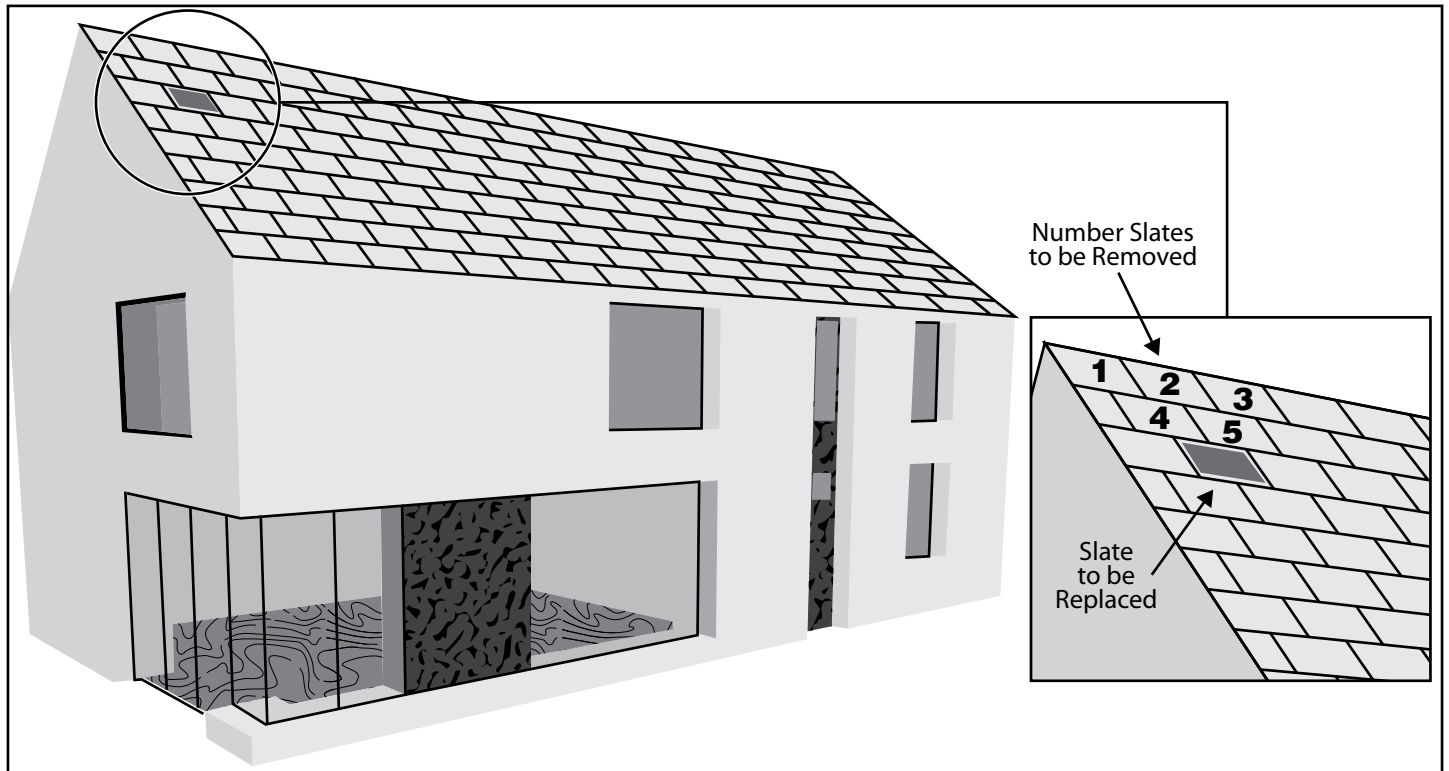

Replacement of the removed slates is the same process in reverse, replacing the carefully stacked and labelled slates in the order they were taken off, taking care not to over tighten the screws and replace any other slate tiles or ridge/hip that may have been damaged during the strip-down process.

# COMPLEMENT YOUR TAPCOSLATE ROOF WITH THE FOLLOWING ACCESSORIES:

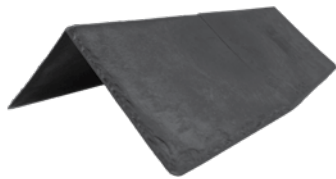

**Classic Ridge & Hip Cap**  
Universal fit

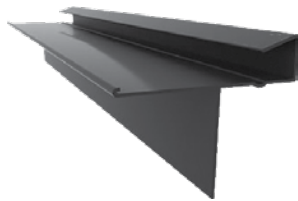

**Dry Verge (2m Lengths)**  
for Classic Slate



**Dry Verge Joining Clips**  
for Classic Slate



**Classic Ridge-to-Hip Junction**  
14°-17°, 18°-24° & 24°-30° Pitches



**Classic Ridge 90° End Cap**  
25°-29°, 30°-34° & 35°-40° Pitches

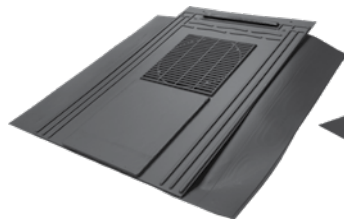

**Inline Slate Vent**  
for Classic Slate

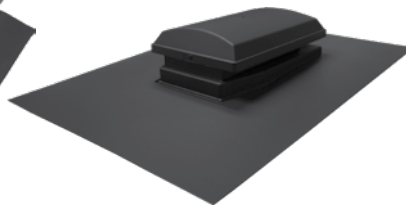

**Cowl Vent**  
for Classic Slate



**Pipe Adapter**  
for inline slate vents



**Pipe Adapter**  
for cowl vents

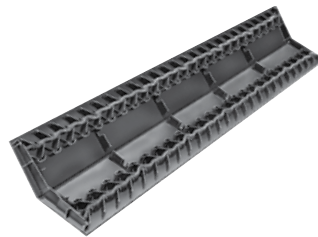

**RidgeMaster Plus**  
Ridge ventilation system

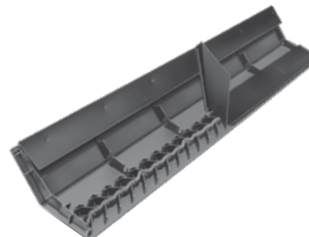

**HipMaster**  
Hip ventilation system



**Eaves Ventilation Systems**  
Warm and cold roof

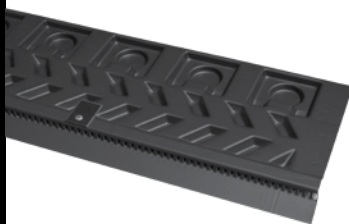

**Abutment Ventilator**  
continuous ventilation system



**Rafter Roll Ventilator**  
450mm rafter ventilation system



**Protect VP300**  
Vapour permeable underlay



**Protect Wunderlay**  
Vapour impermeable underlay

30mm (tile fitment)  
50mm (ridge fitment)  
80mm (RidgeMaster fitment)



**Outdoor Rapier Screws**

30mm (tile fitment)  
50mm (ridge fitment)  
75mm (RidgeMaster fitment)



**Clout Nails**

 **TAPCO ROOFING PRODUCTS**

Unit 32, Tokenspire Business Park, Hull Road, Woodmansey, Beverley, East Yorkshire, HU17 0TB  
Tel: +44 (0)1482 880478 | Fax: +44 (0)1482 880678 | international@tapcoint.com | www.tapcoroofingproducts.com