

FQMC2X\_25ACEND00

# TECHNICAL DATA

## ANTI-ROLL GYRO STABILIZER

ATTACHMENT TO INSTALLATION AND USE MANUAL

EN

page 3

\*ALTRE LINGUE DISPONIBILI SCANSIONANDO IL CODICE QR PRESENTE SUL RETRO DEL SEGUENTE MANUALE O SULL'ETICHETTA ALLOGGIATA SUL PRODOTTO.

\*OTHER LANGUAGES AVAILABLE BY SCANNING THE QR CODE ON THE BACK OF THIS MANUAL OR ON THE LABEL ON THE PRODUCT.

\*OTROS IDIOMAS DISPONIBLES ESCANEANDO EL CÓDIGO QR EN LA PARTE POSTERIOR DE ESTE MANUAL O EN LA ETIQUETA DEL PRODUCTO.

\*AUTRES LANGUES DISPONIBLES EN SCANNANT LE CODE QR AU DOS DE CE MANUEL OU SUR L'ÉTIQUETTE DU PRODUIT.

\*ANDERE SPRACHEN SIND DURCH SCANNEN DES QR-CODES AUF DER RÜCKSEITE DIESER BETRIEBSANLEITUNG ODER AUF DEM AUFKLEBER AM PRODUKT VERFÜGBAR.

\*OUTROS IDIOMAS DISPONÍVEIS, DIGITALIZANDO O CÓDIGO QR NO VERSO DESTES MANUAL OU NO RÓTULO DO PRODUTO.

このマニュアルの裏側または製品に貼られているラベルのQRコードをスキャンすることで利用できる他の言語。

TD\_MC2\_X25\_EN\_R03\_02\_2023





## 1.1 - Technical data

MODEL	<b>MC<sup>2</sup> X25</b>
Rated speed (1)	4000 RPM
Angular momentum (2)	8293 N·m·s
<b>Output torque (3)</b>	<b>25464 N·m</b>
Spool-up time to rated RPM	32 min
Spool-up time to stabilization	25 min
Power absorbed	4500 W max
AC Input voltage	200-240 Vac
Frequency	50-60 Hz
Noise output	< 70 dB
Ambient air temperature	-10°C / +60°C
Weight (4)	840 kg (1852 lb)

(1) Rated speed: flywheel speed (RPM: Revolutions per minute).

(2) Angular momentum: it quantifies the torque that is necessary to balance the system in the time unit (Newtons meter second).

(3) Output torque: torque generated by the rotor at rated speed (Newtons per meter).

(4) Weight with control unit, excluding optional base plate accessory, standard or custom.

## 1.2 - Power Absorbtion

MODEL MC <sup>2</sup>	POWER ABSORBED [W]	220V	
		AMPERE 1F [A]	CIRCUIT BRAKER [A]
25	4500	20	25

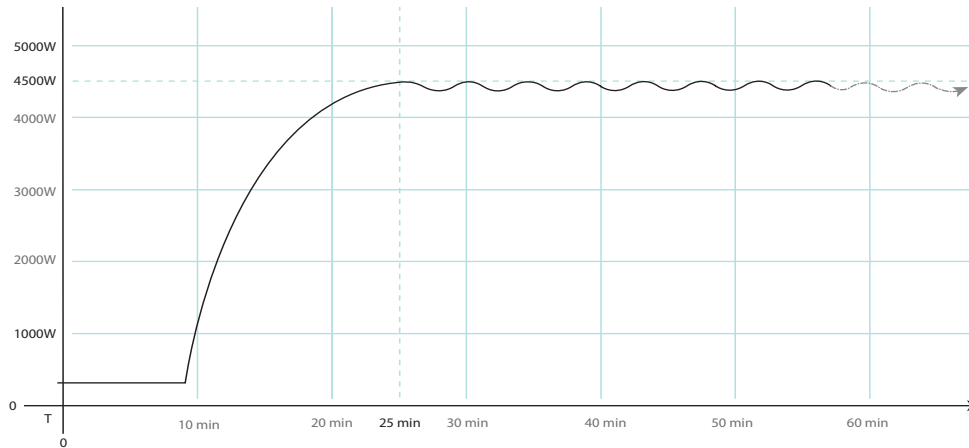

## 1.3 Dimensions

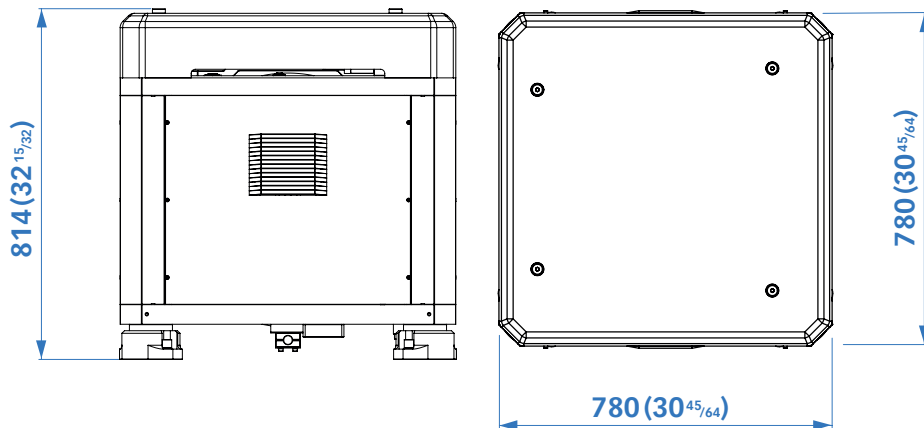

## 1.4 Dimensions with base plate (optional)

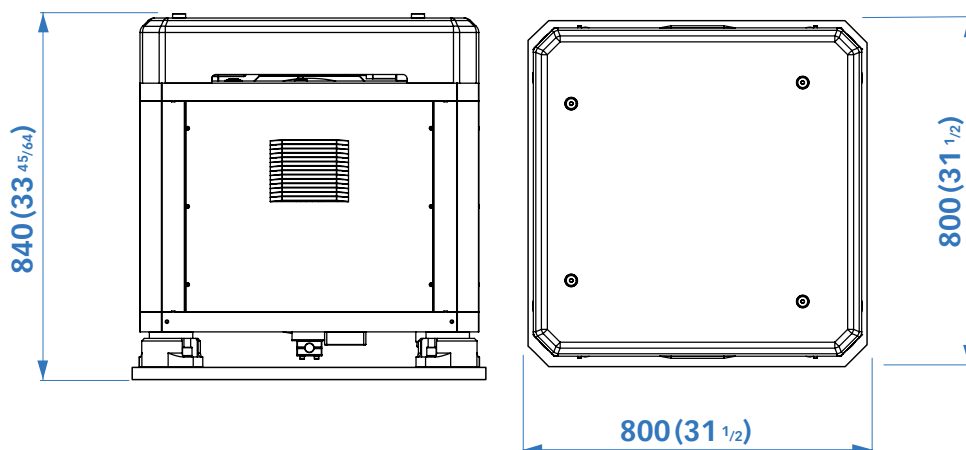



## 1.5 - Preliminary technical checks

Before proceeding to the installation, it is essential to make sure that the position chosen and the boat structure can withstand and enable the transfer of the loads generated by the gyroscope on the hull.

### Load generated by MC<sup>2</sup>X13

To calculate the structure sizing load use a safety factor (R = 3)

### MC<sup>2</sup>X25

$$25464 \text{ N}\cdot\text{m} \times 3 = 76392 \text{ N}\cdot\text{m}$$

(1Kg = 9,81 N)

The supporting base must be properly dimensioned in order to withstand the declared stabilizing torque (Nm).

By sharing the total stabilizing torque on the three directions for each fixing screw (8 screws), the following torque will result on each dimension:

- Fz: 57 kN
- Fx: 87 kN
- Fy: 77 kN

These forces are to be considered as acting simultaneously.

They do not include the tensions introduced by marine motions during navigation.

If the installer do not able to guarantee that the boat structure is able to withstand and transfer the loads in the hull generated by the gyroscope, a qualified technician or a naval engineer should intervene in order to carry out a suitable structural analysis on site.

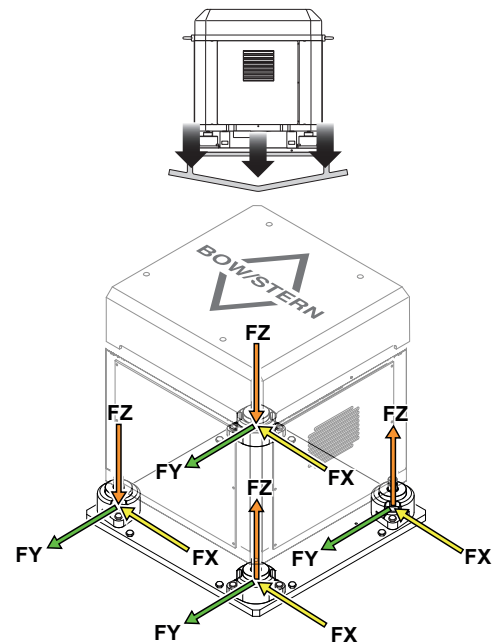

---

## 1.6 - General instructions and precautions

The weight to be considered for lifting the is:

$$\text{MC}^2\text{X25} = 880 \text{ kg (1940 lb)}$$



### 1.7 - Drilling Template

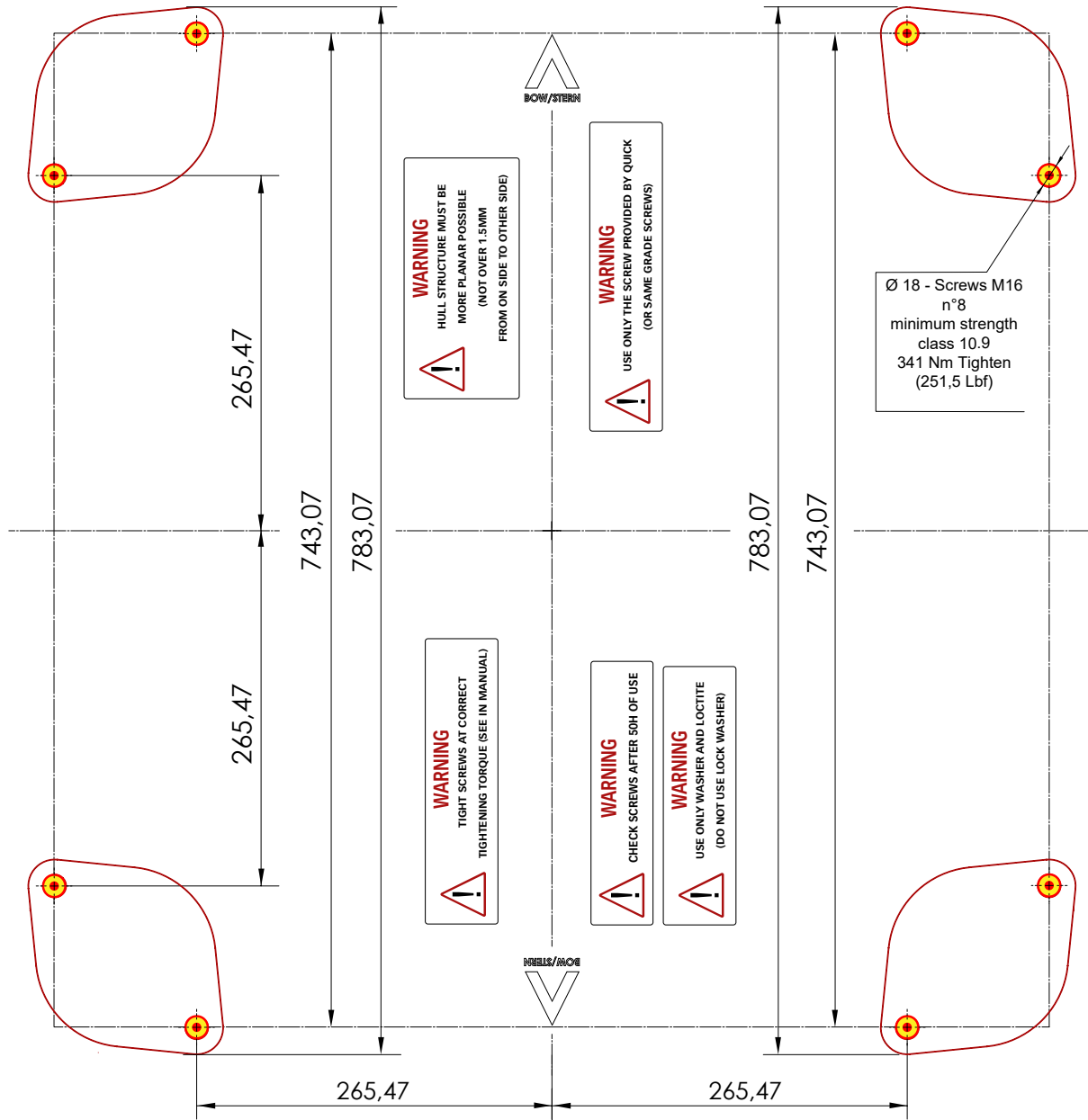

**mc<sup>in</sup>**  
QUICK GYRO **X25 X30**



### 1.7 - Drilling Template

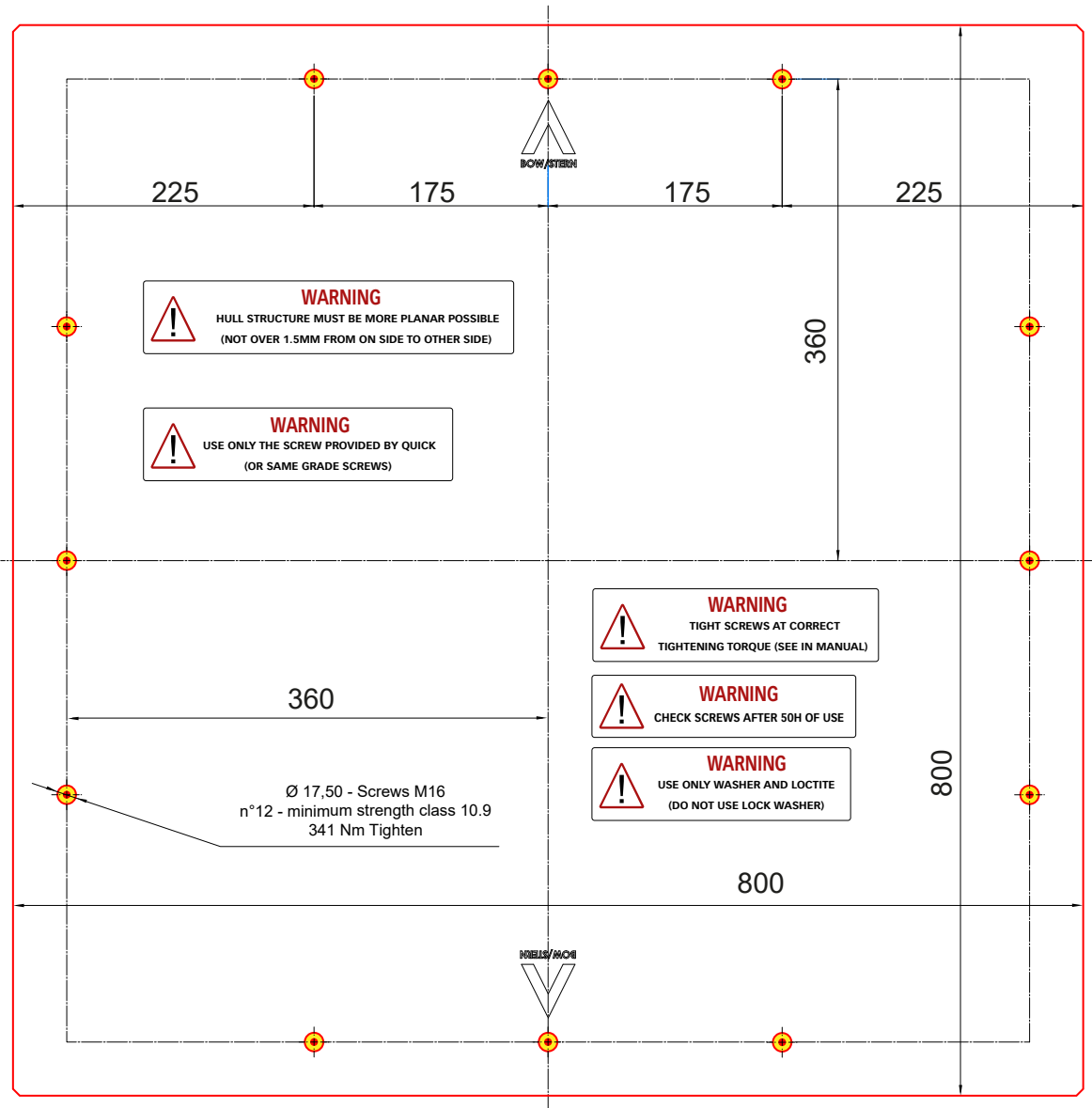

mc<sup>2</sup> QUICK GYRO X25 X30



FEBRUARY 2023

CTDX25ACEN00

# TECHNICAL DATA

## ANTI-ROLL GYRO STABILIZERS

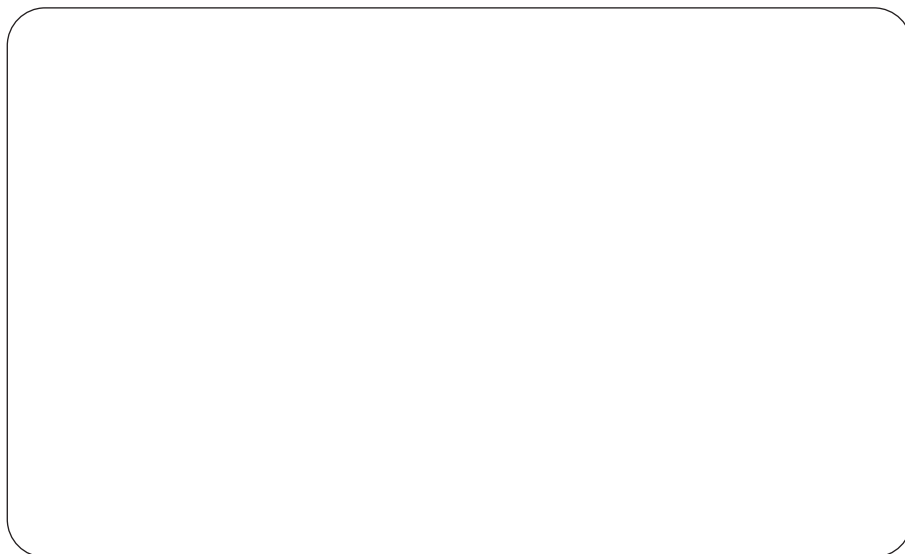

Product code and serial number

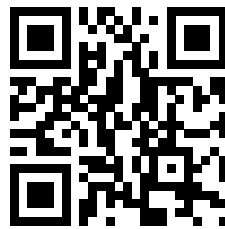

\*ALTRE LINGUE DISPONIBILI SCANSIONANDO IL CODICE QR  
\*OTHER LANGUAGES AVAILABLE BY SCANNING THE QR CODE  
\*OTROS IDIOMAS DISPONIBLES ESCANEANDO EL CÓDIGO QR  
\*AUTRES LANGUES DISPONIBLES EN SCANNANT LE CODE QR  
\*ANDERE SPRACHEN SIND DURCH SCANNEN DES QR-CODES  
\*OUTROS IDIOMAS DISPONÍVEIS, DIGITALIZANDO O CÓDIGO QR  
QRコードをスキャンして利用できる他の言語。



QUICK® S.p.A. - Via Piangipane, 120/A - 48124 Piangipane (RAVENNA) - ITALY  
Tel. +39.0544.415061 - Fax +39.0544.415047 - [www.quickitaly.com](http://www.quickitaly.com) - [quick@quickitaly.com](mailto:quick@quickitaly.com)