

Lydsto Inertial Navigation Sweeping  
and Mopping Robot G1  
Instruction Manual

# Contents

---

Safety instructions .....	2
Product components .....	4
Product usage .....	7
Product maintenance .....	10
Product specification .....	13
Troubleshooting .....	14

# Safety Instructions

---

**Restrictions on use** • Plastic bags are dangerous! Keep plastic bags out of the reach of infants and children to avoid suffocation.

- This product is designed only for cleaning the floor in the home environment. Do not use it outdoors (such as open balcony), in places other than the floor (such as sofa), or in commercial or industrial environment.
- Do not use the product in hanging places (such as duplex floor, open balcony, top of home) without any protective rail.
- Do not use the product in the environment above 40 °C, below 0 °C or with any liquid and viscous substances on the ground.
- Before use, please hang up the ground cable at home to avoid dragging the cable when the machine is operating.
- Put away the fragile articles and sundries (such as flower bottles and plastic bags) on the ground to prevent the machine from being blocked or hit during operation, causing damage to valuables.
- Do not let those who are physically, perceptually and intellectually deficient or lacking of experience and common sense (including children) use the product without monitoring or guidance.
- Do not let children use the product as a toy.
- Do not put the main brush cleaning tool in a place accessible to children.
- Keep the hair, fingers and other parts of men or pets away from the suction inlet of the machine when the machine is operating.
- Do not use the product to clean any burning objects (such as cigarette ends that are not extinguished).
- Do not absorb hard or sharp objects (such as decoration wastes, glass and nails) with the machine.
- Do not handle the machine with the protective cover of the laser distance measuring sensor, the upper cover of the machine and the collision buffer as the lifting hand.
- To clean and maintain the machine and the charging pile, you must turn off the machine, pull out the plug from the socket and disconnect the power supply first.
- Do not immerse the machine and the charging base in water for cleaning or flush them with water.
- Do not wipe any part of the product with a damp cloth or any liquid.
- Do not use the floor mopping module on the carpet.
- Do not use it under direct sunlight.
- Use the product according to the instructions. Any loss and injury caused by improper use shall be borne by the user.

## Battery and charging

- Even if the product has been seriously damaged, it is strictly forbidden to burn the product, because the product battery may cause explosion.
- Do not use the batteries, chargers and charging base of any third party.
- Do not disassemble, repair or refit the battery and charging pile without permission.
- Do not place the charging base close to heat sources (such as radiator).
- Do not wipe or clean the dome of the charging pile with a damp cloth or wet hands.
- Do not discard used batteries at will. Before discarding the sweeping and mopping robot, the power supply must be disconnected and the batteries should be taken out of the sweeping and mopping robot for environmental protection.
- In order to avoid danger, any damaged power cord must be replaced by professionals from the manufacturer, its maintenance department or similar departments.
- If you need to transport the product, make sure that the machine is turned off and it is recommended to use the original package.
- Do not pour water into the device or immerse it in water.
- If it will be not used for a long time, fully charge the machine, turn it off and put in a cool and dry place. Charge the machine at least once every three months to avoid battery damage due to over discharge.
- This appliance contains batteries that are only replaceable by skilled persons.

## Warn

- This appliance can be used by children aged from 8 years and above and persons with reduced physical, sensory or mental capabilities or lack of experience and knowledge if they have been given supervision or instruction concerning use of the appliance in a safe way and understand the hazards involved.
- Children shall not play with the appliance.
- Cleaning and user maintenance shall not be made by children without supervision.
- This appliance contains batteries that are only replaceable by skilled persons.
- The appliance is only to be used with the unit provided that model is AD-0121900060EU.

# Product components

## 1.1 Main body

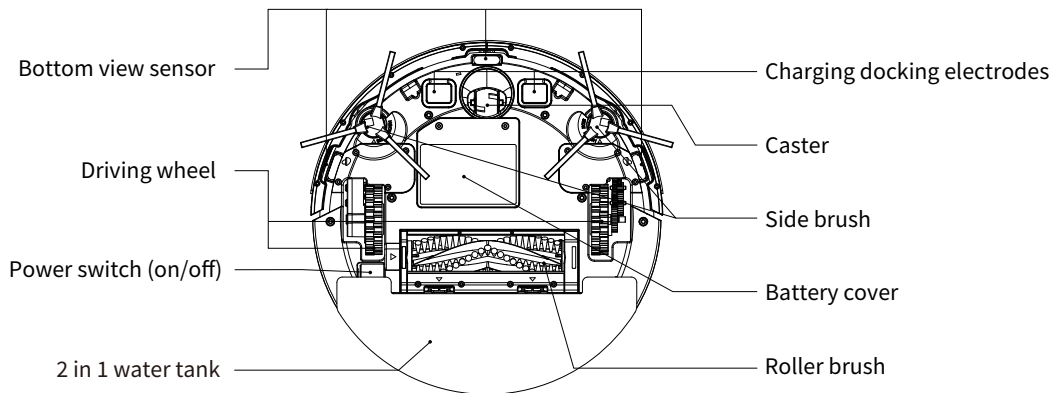
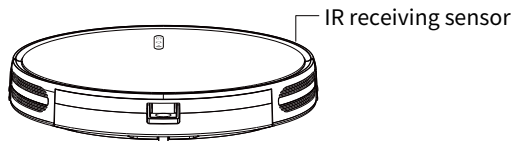
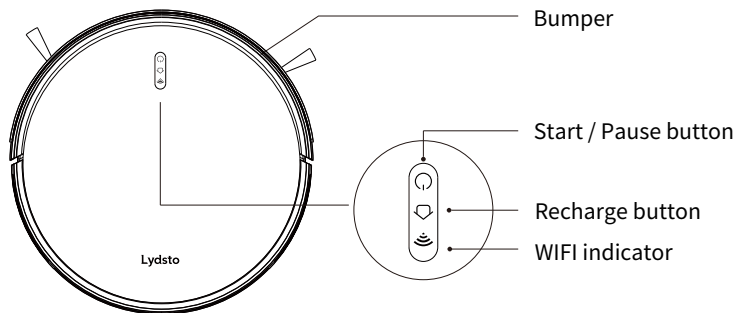

## 1.2 Product and other components

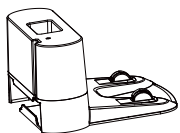

Charging base

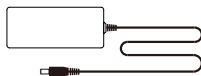

Adapter

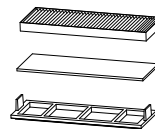

Sponge filter and efficient filter screen

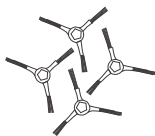

4 x side brushes



Roller brush

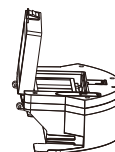

2 in 1 water tank



Cleaning brush

## 1.3 Charging base

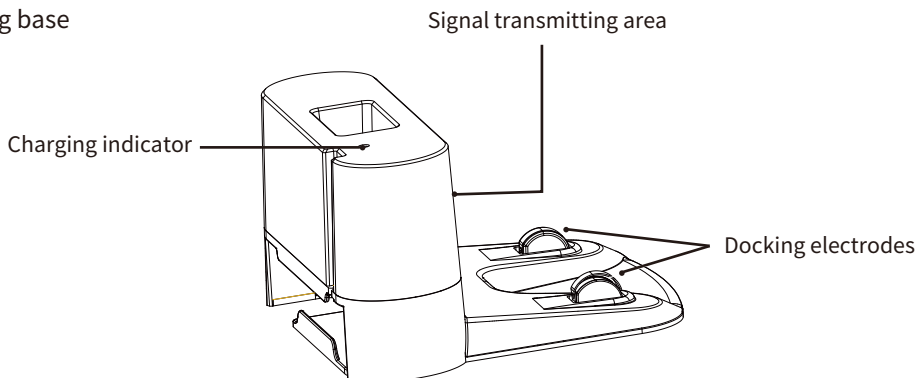



## Connect to Lydsto APP

Lydsto APP can be downloaded from Apple APP market or Google APP market.

Or Scan the following QR code,Download and install Lydsto APP.



## Reset Wi Fi

Press  button and  button for 3 seconds at the same time, and hear the sound prompt "Wi-Fi has been reset". WiFi indicator flashes in white, the sweeping robot enters the waiting state for connection; after connecting, WiFi indicator is steady white.

Tips: only 2.4GHz frequency band Wi Fi network is supported.

# Product usage

## 2.1 Quick start

1. Connect the charging base and put the remaining cord into the cord storage box on the bottom of the charging base.

**Warm prompt: the cord not retracted may trap the cleaning or recharge-searching machine.**

2. Position of charging base

1. The charging base leans on the wall and lays on flat ground.

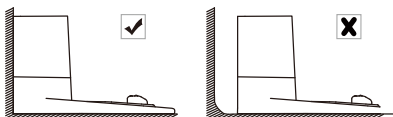

2. Ensure to place the charging base against wall and not spare any gap.

- Ensure free space around the charging base with 2m right ahead and 1m on both sides.

3. Connect the adapter plug to the power socket of the charging base and the other end to the socket on the wall.

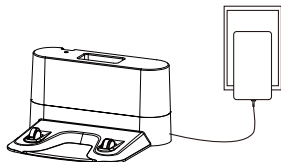

**Warm prompt: ensure the indicator is on when the charging base is powered on, otherwise, the product cannot recharge automatically.**

3. To install the side brush, clip it into the slot and a sound “click” indicates it in place.
4. Switch on the on-off key on the bottom of machine (1 denotes switch-on, 0 denotes switch-off).

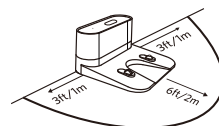
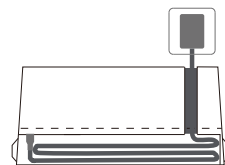
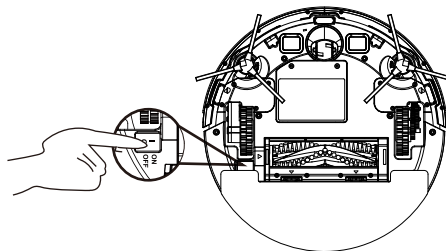
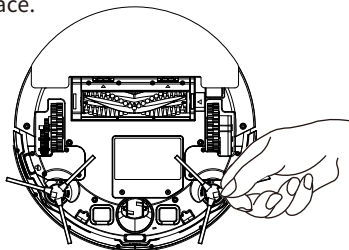



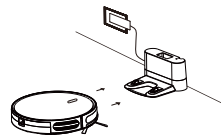

## 5. Activate the product

Ensure the metal docking electrodes on the charging base match the metal charging electrodes on the bottom of robot. Place the product on the charging base. If the activation is successful, the product will sound a sequence of ticks. Once the on-off key lights up, the product is ready to run.



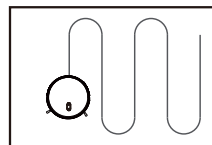

## 6. Start cleaning

- Press  once to wake up the machine.
- Press  or  on the APP, the machine will start automatic cleaning.





## 7. Pause

- Press  on the machine to pause the machine under cleaning.
- To continue cleaning, press again  on the machine.



## 2.2 Cleaning mode

### 1. Automatic cleaning

- Press  machine or  on the APP to start automatic cleaning.
- If the battery is low before the cleaning is completed, the machine will return to the charging base to recharge.



**Warm prompt: the machine may fail to find the charging base to recharge, then it will blink the red indicator and sound four “ticks” . Please manually put the machine into the charging base to recharge.**

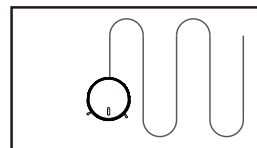

### 2. Wet mop cleaning

G1 provides a 2 in 1 water tank and the robot can preform wet mop on the floor.

1. Tie up the cloth and fill up the 2 in 1 water tank.

2. Put the 2 in 1 water tank into the machine and start the robot.

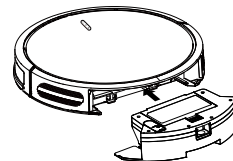
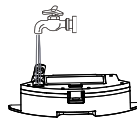
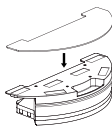

### 3. Fixed-point cleaning

Select the fixed-point cleaning mode, then the machine will rotate spirally outward and clean only a local area of about 1m diameter and then circle inward to the starting point. Provide the optimum cleaning on the necessary site for you. Please place the machine on the dirty location, then press the “Spot cleaningon” the APP.

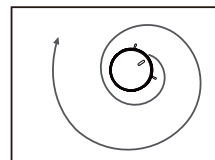

### 4. Side cleaning

Press the “Along the edgeon” the APP, the side cleaning mode can ensure a cleaning along the wall and around the furniture legs.

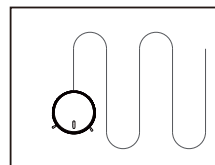

## 2.3 Time and reserved timed cleaning

The machine can perform a reserved setting for cleaning time. The reserved timing function can only be realized with the APP. Please ensure the time on the APP is consistent with your local time before reserving a timed cleaning.

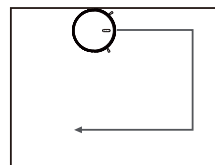

## Product maintenance

In order to ensure the service life and optimum cleaning performance of the mopping robot, please refer to the following instructions to clean and maintain the components.

Recommended cleaning / replacement frequency:

Machine component	Cleaning frequency	Replacement frequency
2 in 1 water tank	After each use	—
Filter	Weekly	Every 2 months
Roller brush	Weekly	Every 6-12 months
Side brush	Monthly	Every 3-6 months (or in case of severe wear)
Roller brush protective rail	Monthly	Every 3-6 months (or in case of severe wear)
Sensor	Monthly	—
Charging electrode	Monthly	—
Caster	Monthly	—

### 3.1 Empty the 2 in 1 water tank

**1.** Press the 2 in 1 water tank release button to take it down.

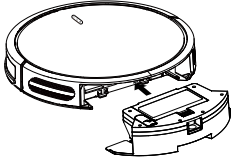

**2.** Open the 2 in 1 water tank cover to empty it.

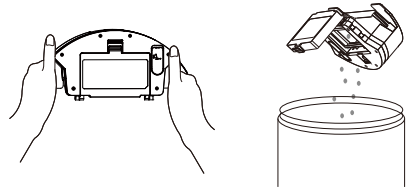

### 3.2 Clean filter

**1.** Grab the white label to remove the filter.

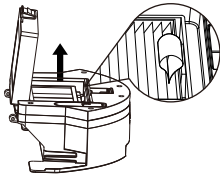

**2.** Shake off the trashes on the filter.

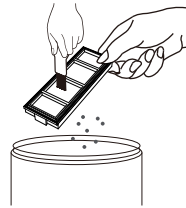

### 3.3 Clean side brush, roller brush, caster and sensor

**1.** Take down the roller brush and clean the dusting channel with a cloth.

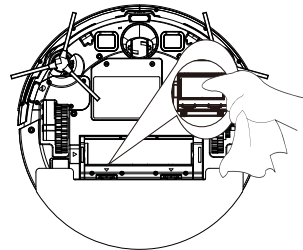
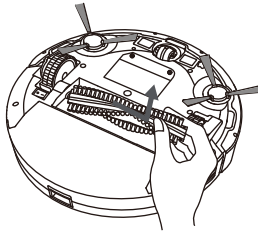
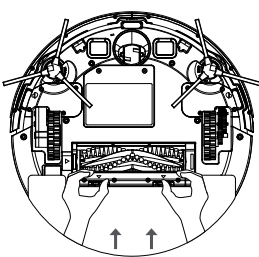

2. Clean the roller brush and remove the hair wound on the roller brush using the provided cleaning tool.

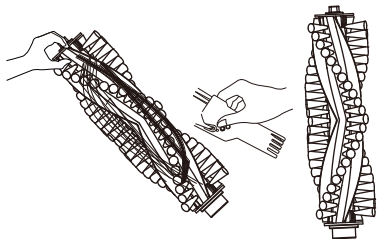

3. Take down the side brush. Clean the side brush with a cloth.

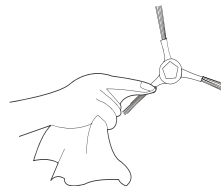

4. Use the cleaning brush to clean the caster.

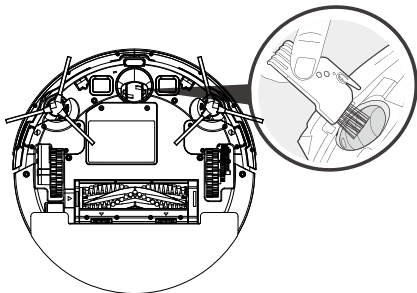

5. Use the cleaning brush to clean the dust on the sensor to ensure the optimum performance.

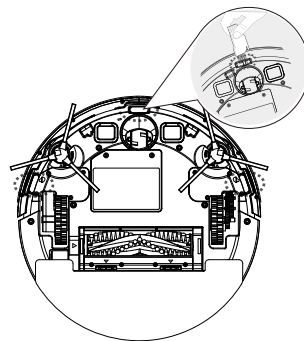

# Indicator and alarm prompt

## Indicator prompt

Machine status	Display status
Charging	Yellow indicator breathing
Charging completed	Blue indicator keeps on
Machine fails	Red indicator keeps on / blinks
Low battery	Blue indicator keeps on
Cleaning mode	Blue indicator keeps on
Configure network	White indicator quickly blinks
Configure network successfully	White indicator keeps on
Network not configured / fails to configure network	White indicator slow flash
turn-off	Off

## Alarm prompt

In case of machine failure, the  button on the machine blinks red or keeps on and sounds a “tick” . You can refer to the following table to check the trouble cause:

### Red indicator blinks:

SN	Prompt tone	Causes	Solution
01	1 time	The gyroscope is abnormal	Place the robot on stable location and restart. Do not move the machine
02	2 times	The front bumper is abnormal	Check the front bumper is jammed by foreign body
03	3 times	The bottom view sensor is abnormal	Check there is dust on the bottom view sensor and wipe it
04	4 times	Low battery or abnormal charging	The machine voltage is too low and needs artificial assistance to charge

## Red light keeps on

SN	Prompt tone	Causes	Solution
01	1 time	Driving wheel is abnormal	Check the driving wheel is wound and clean the side brush
02	2 times	The side brush is abnormal	Check the side brush is wound and clean the side brush
03	3 times	The fan is abnormal	Clean the trash in dust bin and suction inlet
04	4 times	The roller brush is abnormal	Check the roller brush is wound and clean it

### Notes

If the methods above fail to solve the problems, please try the following actions:

- 1、Restart the machine using the power switch on the machine side.
- 2、If the problems continue even the machine is started again, please send the machine to the after-sale service center to repair.

## Product specification

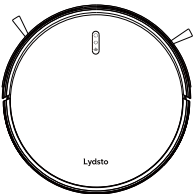
	Product model	YM-G1-B01、YM-G1-W01
	Input	19 V $\approx$ 0.6 A
	Operating voltage	14.4 V
	Rated power	40 W
	Battery type	DC 14.4 V Li-ion 2600 mAh
	Dust bin volume	250mL
	Maximum cleaning duration	120min
	Charging time	300-360min

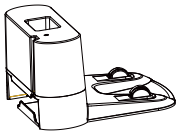
	Input	19 V $\approx$ 0.6 A
	Output	19 V $\approx$ 0.6 A

This device contains a wireless transmitter module with model approval code:  
CMIIT ID: 2020DP6462.

# Troubleshooting

In case of any problem below during product use, please check accordingly and solve it independently.

SN	Fault conditions	Possible reason	Solution
1	Machine fails to charge	The charging electrodes of machine and charging base fail to fully contact with each other.	Ensure to fully contact the charging electrodes of machine and charging base.
		The power supply for the charging base is shutdown but the machine power switch is turned on, resulting in energy loss.	When the machine is not in use, it is recommended to maintain it in charging state so as to get ready for subsequent operation.
2	Machine gets trouble during working	The machine is wound or hindered by the messy wires, hung curtain or carpet fringe.	The machine will try to escape independently via various ways. If it fails, it is recommended to assist it manually.
3	Machine goes to recharge when the cleaning is not completed	The machine under working can sense low battery and return to recharge automatically.	Recharge the machine.
		The machine works at different speeds or for different durations on flat floor such as wooden floor and tiles.	The machine running duration is different for different room complexity, trash amount or cleaning modes.
4	The machine fails to perform automatic cleaning as reserved time	The power switch of the machine is not turned on, thus the machine cannot work independently as the reserved time because it is in off state.	Turn on the machine power switch.
		Low machine battery.	When in standby, the machine should charge on the charging base to ensure sufficient power for subsequent operation.
		The machine component is blocked or wound by trash.	Switch off the power supply, clean the dust bin, then turn the machine bottom upward and clean various components separately.

