



Sideline® Series Electric Fireplace Heater **OWNER'S MANUAL**



28" / 36" / 40" / 45" / 50" / 60" / 72" / 84" / 100"
Sideline® Series Recessed Electric Fireplace

AC 110-120V 60Hz 1500W

Model#: 80004, 80011, 80014, 80015, 80025, 80027, 80028, 80029,
80032, 80043



800.215.1990



sales@thpus.com



touchstonehomeproducts.com

IMPORTANT SAFETY INFORMATION **3**

CSA Approval Listing Information	4
Fireplace Specifications	4
Serial Number Label	5

DIMENSIONAL DRAWINGS **6**

80004 – Sideline® 50” Dimensions	6
80011 – Sideline® 60” Dimensions	7
80014 – Sideline® 36” Dimensions	8
80015 – Sideline® 72” Dimensions	9
80025 – Sideline® 45” Dimensions	10
80027 – Sideline® 40” Dimensions	11
80028 – Sideline® 28” Dimensions	12
80029 – Sideline® 50” White Dimensions	13
80032 – Sideline® 100” Dimensions	14
80043 – Sideline® 84” Dimensions	15

UNPACKING YOUR FIREPLACE **16**

Parts and Hardware	16
Tools Required	16
What’s in the Box	16
Unpacking and Setup	16
Wiring	16
Testing the Fireplace Prior to Installation	17
3-prong Outlet Installation	17
Hard Wire Connection	18

INSTALLATION **19**

Choosing Installation Location	19
Removing the Glass Panel	20
Recessed Installation	21
Crystal Embers and Fire Log Installation	23
Re-installing the Glass Panel	24
Wall Mounted Installation	25

OPERATING THE FIREPLACE **28**

Power	28
Remote Control Operation	29
Temperature Limiting Control	29

CARE, CLEANING AND MAINTENANCE **30**

WARRANTY **31**

Important Safety Information

PLEASE READ CAREFULLY FOR SAFE OPERATION

- **THIS FIREPLACE IS HOT WHEN IN OPERATION AND CAN CAUSE SEVERE INJURY.**
- Do not operate fireplace before reading and understanding operating instructions. Failure to operate fireplace according to operating instructions could cause fire or injury.
- Risk of injury. This fireplace is HOT when in operation and heating element is ON. Power to the fireplace should be turned OFF and the fireplace allowed to cool before servicing. To disconnect power to the fireplace, turn controls to OFF, then remove plug from outlet.
- Do not install damaged, incomplete, or substitute components.
- Young children should be carefully supervised when they are in same room with fireplace. Toddlers, young children and others may be susceptible to accidental contact burns. A physical barrier is recommended if there are at-risk individuals in the house. To restrict access to the fireplace, install an adjustable safety gate to keep at-risk individuals away from the fireplace and hot surfaces.
- Clothing and other flammable material should not be placed on or near the fireplace.
- Due to high temperatures, the fireplace should be located out of traffic and away from furniture and draperies.
- It is imperative that the control compartments, circulating blower, and its passageway are kept clean.
- Under no circumstances should this fireplace be modified.
- Do not use the fireplace if any part has been under water.
- Do not operate the fireplace with the glass panel removed, cracked or broken.
- Keep the packaging material out of the reach of children. As with all plastic bags, these are not toys and should be kept away from children and infants.
- Servicing should only be done while the fireplace is disconnected from the power outlet.
- Unplug fireplace if not being used for an extended period of time.
- Always plug this fireplace into a wall outlet or receptacle. Never plug this fireplace into a surge protector, extension cord, or relocatable power tap.
- Do not operate this fireplace with a damaged cord or plug, after the fireplace malfunctions, or has been dropped, or damaged in any manner.
- Do not use outdoors.
- Never locate fireplace where it may fall into a bathtub or other water container.
- Do not place the cord under carpeting. Do not cover cord with throw rugs, runners, or the like. Arrange cord away from traffic area and where it will not be tripped over.
- Connect to properly grounded outlets or hard wire connection only.
- Do not insert foreign objects into any ventilation or exhaust opening as this may cause electric shock, fire, or damage to the fireplace.
- To prevent a possible fire, do not block the air intakes or exhaust in any manner. Do not use on soft surfaces, like a carpet, where openings may be blocked.
- Ensure clearances to combustibles are maintained when building a mantel or shelves above the fireplace. Elevated temperatures on the wall or in the air above the fireplace can cause melting, discoloration or damage to decorations, television or other electronic components.

CSA Approval Listing Information

This fireplace has been tested in accordance with the CSA Standards for fixed and location-dedicated electric room appliances in the United States and Canada. If you need assistance during installation, please contact our technical support department at 800-215-1990.

Note: This fireplace must be electrically wired and grounded in accordance with local codes or, in the absence of local codes, with National Electric Code ANSI/NFPA 70-latest edition in the United States or the Canadian Electric Code, CSA C22.1 in Canada.

Fireplace Specifications

Model Number	80004	80011	80014	80015	80025
Description	Sideline® 50	Sideline® 60	Sideline® 36	Sideline® 72	Sideline® 45
Voltage	120v AC	120v AC	120v AC	120v AC	120v AC
Watts	Max 1500W	Max 1500W	Max 1500W	Max 1500W	Max 1500W
Amps	12 AMP	12 AMP	12 AMP	12 AMP	12 AMP
Fireplace Width	50"	60"	36"	72"	45"
Fireplace Height	21 ½"	21 ½"	21 ½"	21 ½"	21 ½"
Fireplace Depth	5 ½"	5 ½"	5 ½"	5 ½"	5 ½"
Shipping Weight	60 lbs	70 lbs	38 lbs	110 lbs	55 lbs
Fireplace Weight	65 lbs	100 lbs	47 lbs	150 lbs	59 lbs

Model Number	80027	80028	80029	80032	80043
Description	Sideline® 40	Sideline® 28	Sideline® 50 White	Sideline® 100	Sideline® 84
Voltage	120v AC	120v AC	120v AC	120v AC	120v AC
Watts	Max 1500W	Max 1500W	Max 1500W	Max 1500W	Max 1500W
Amps	12 AMP	12 AMP	12 AMP	12 AMP	12 AMP
Fireplace Width	40"	28"	50"	100"	84"
Fireplace Height	21 ½"	16 ½"	21 ½"	21 ½"	21 ½"
Fireplace Depth	5 ½"	5 ½"	5 ½"	5 ½"	5 ½"
Shipping Weight	41 lbs	25 lbs	60 lbs	150 lbs	125 lbs
Fireplace Weight	49 lbs	33 lbs	65 lbs	175 lbs	140 lbs

Serial Number Label

Each Touchstone Home Products Electric Fireplace contains a serial number label on the shipping box. Please remove the shipping label and place the label on the back page of this manual for future reference.

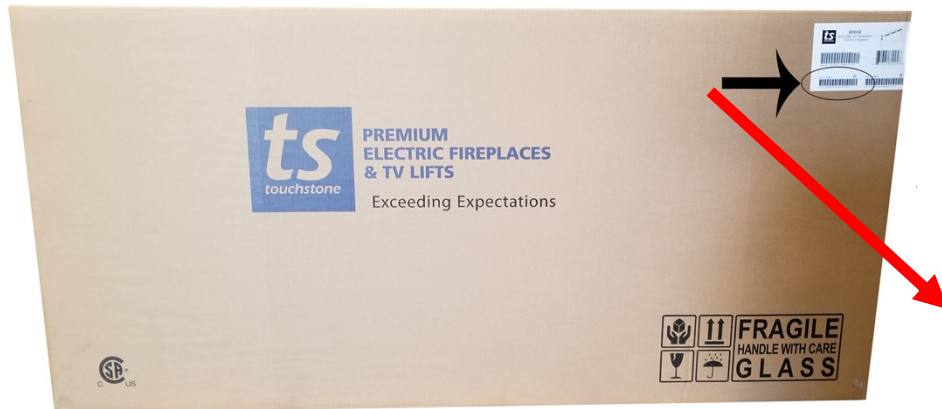

Sideline® Elite Series Electric Fireplace 28

STOP CALL US FIRST! STOP
DO NOT RETURN TO STORE.

For immediate help with assembly, product information,
or if your product arrives damaged, call our toll-free number at

800-215-1990

or email:
customerservice@thpus.com

Our staff is ready to provide assistance.

Affix Serial Number Label Here

 www.touchstonehomeproducts.com 800.215.1990

Dimensional Drawings

80004 – Sideline® 50” Dimensions

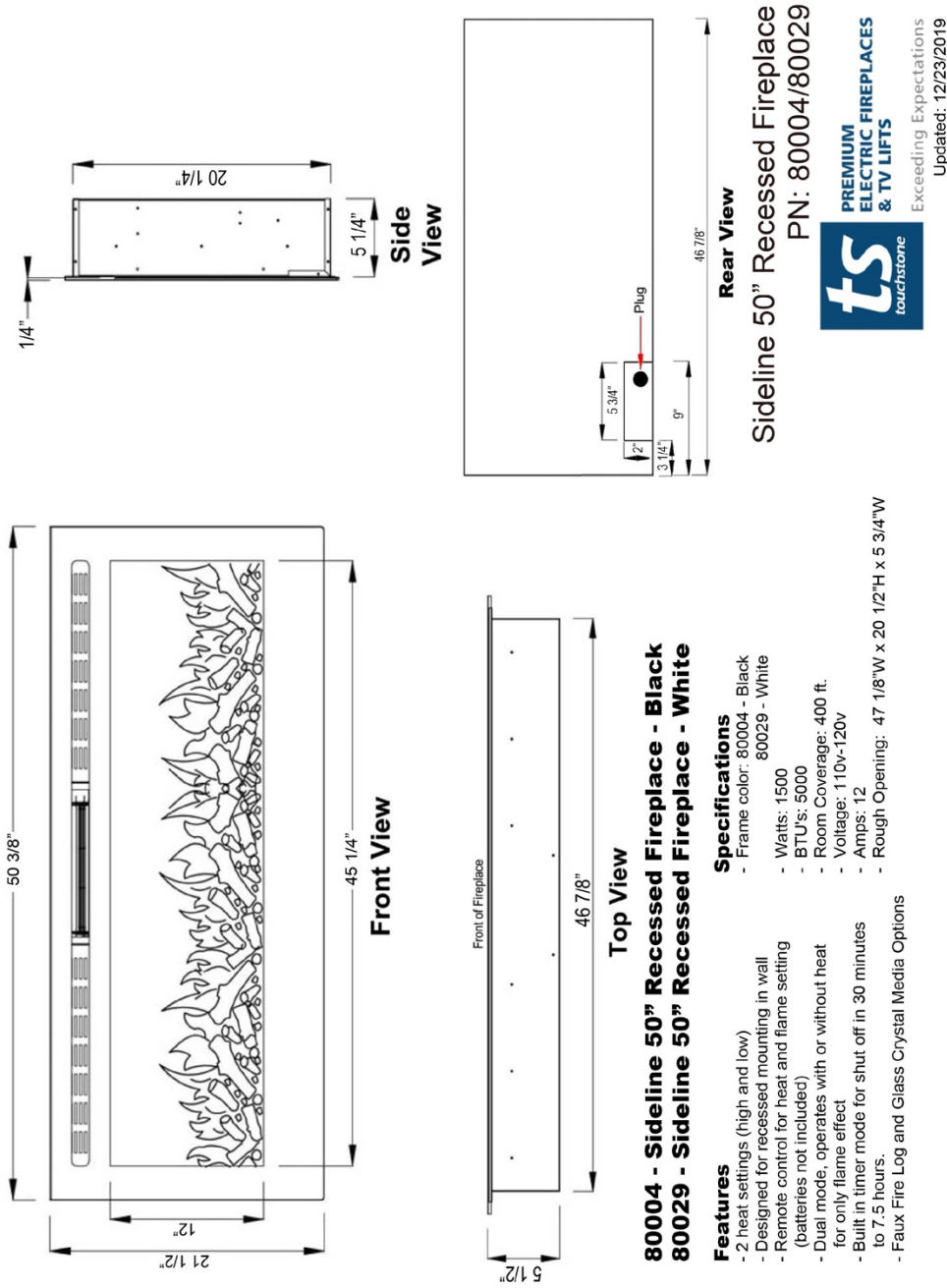

80011 – Sideline® 60” Dimensions

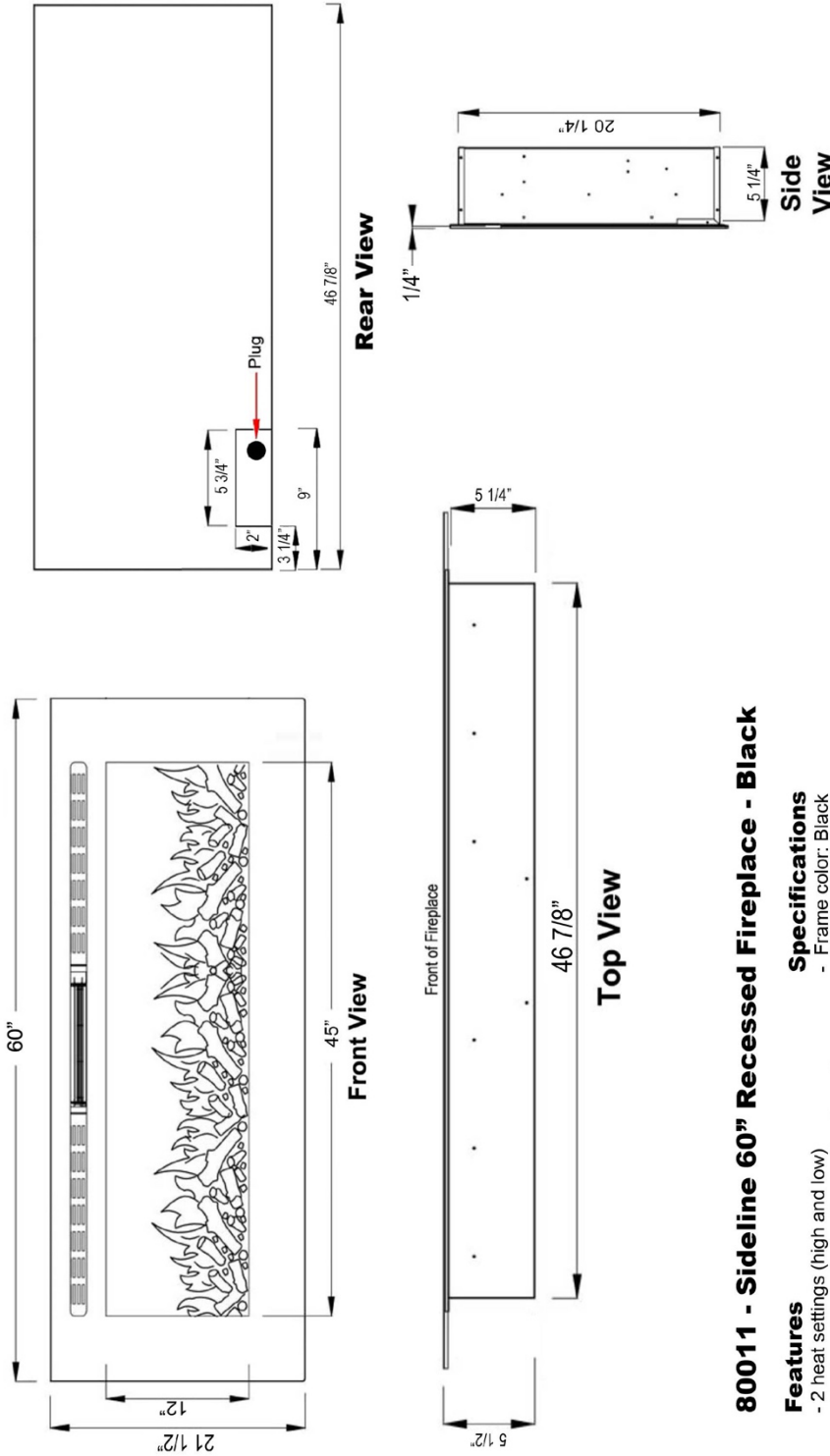

80011 - Sideline 60” Recessed Fireplace - Black

Features

- 2 heat settings (high and low)
- Designed for recessed mounting in wall
- Remote control for heat and flame setting (batteries not included)
- Dual mode, operates with or without heat for only flame effect
- Built in timer mode for shut off in 30 minutes to 7.5 hours.
- Faux Fire Log and Glass Crystal Media Options

Specifications

- Frame color: Black
- Watts: 1500
- BTU's: 5000
- Room Coverage: 400 ft.
- Voltage: 110v-120v
- Amps: 12
- Rough Opening: 47 1/8"W x 20 1/2"H x 5 3/4"TW

Sideline 60” Dimensions
 PN: 80011



PREMIUM
 ELECTRIC FIREPLACES
 & TV LIFTS

Exceeding Expectations

Updated: 12/23/2019

80014 – Sideline® 36” Dimensions

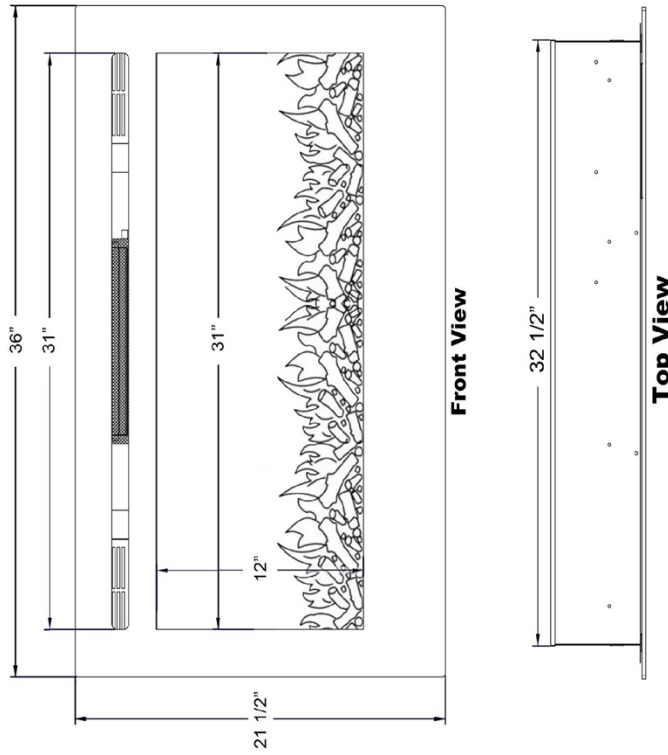
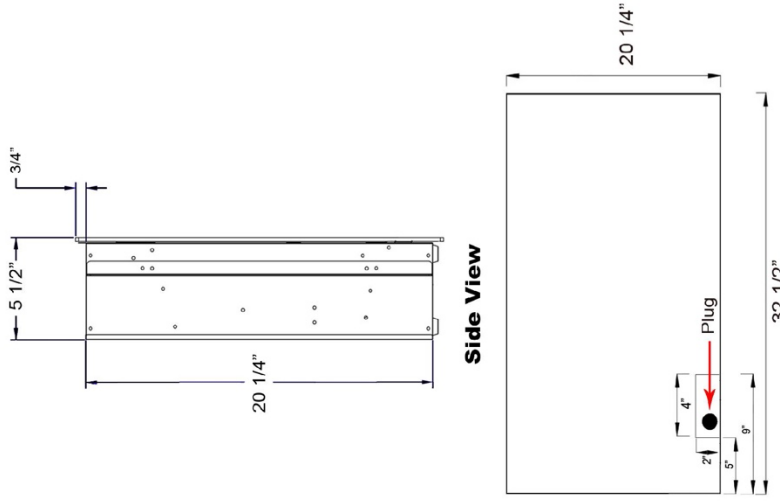

80014 - Sideline 36” Recessed Fireplace

Features

- 2 heat settings (high and low)
- Designed for recessed mounting in wall
- Remote control for heat and flame setting (batteries not included)
- Dual mode, operates with or without heat for only flame effect
- Built in timer mode for shut off in 30 minutes to 7.5 hours.
- Faux Fire Log and Glass Crystal Media Options

Specifications

- Frame color: Black
- Watts: 1500
- BTU's: 5000
- Room Coverage: 400 ft.
- Voltage: 120v
- Amps: 12
- Rough Opening: 32 3/4" W x 20 1/2" H x 5 3/4" D

Sideline 36” Recessed Fireplace
PN: 80014



PREMIUM
ELECTRIC FIREPLACES
& TV LIFTS
Exceeding Expectations

Updated: 12/23/2019

80015 – Sideline® 72” Dimensions

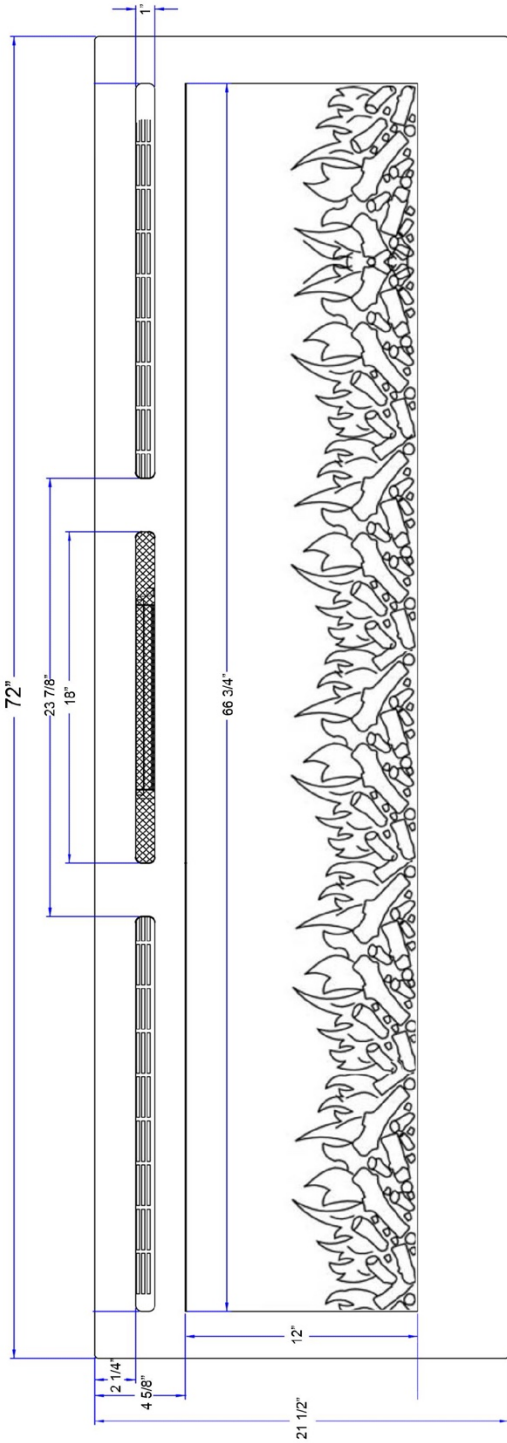

Front View

Side View

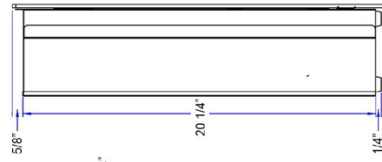

Side View

Front View

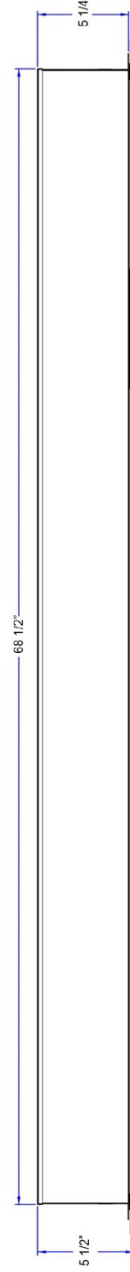

Front of Fireplace

Top View

80015 - Sideline 72” Recessed Fireplace

Features

- 2 heat settings (high and low)
- Designed for recessed mounting in wall
- Remote control for heat and flame setting (batteries not included)
- Dual mode, operates with or without heat for only flame effect
- Built in timer mode for shut off in 30 minutes to 7.5 hours.
- Faux Fire Log and Glass Crystal Media Options

Specifications

- Frame color: Black
- Watts: 1500
- BTU's: 5000
- Room Coverage: 400 ft.
- Voltage: 120v
- Amps: 12
- Rough Opening: 68 3/4" W x 20 1/2"H x 5 3/4" D

Sideline 72” Recessed Fireplace

PN: 80015



PREMIUM
ELECTRIC FIREPLACES
& TV LIFTS

Exceeding Expectations

Updated: 12/23/2019

80025 – Sideline® 45” Dimensions

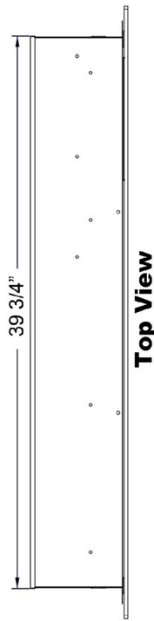
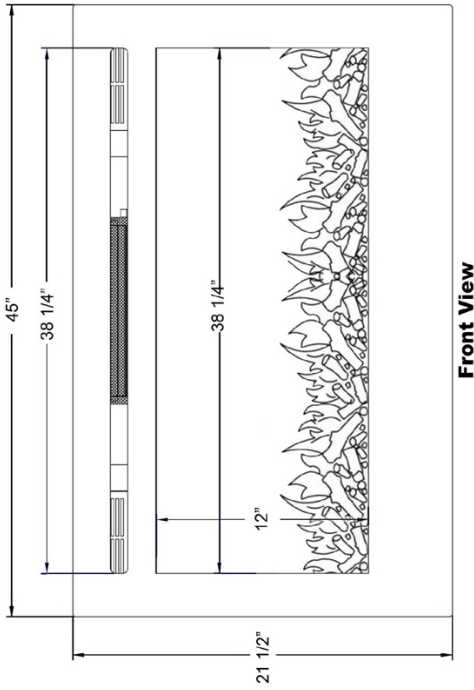
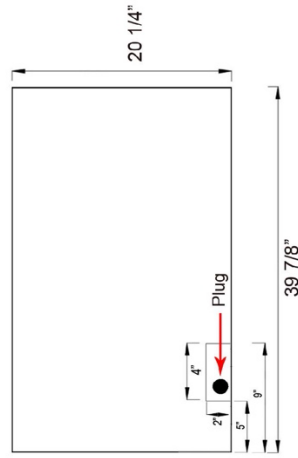
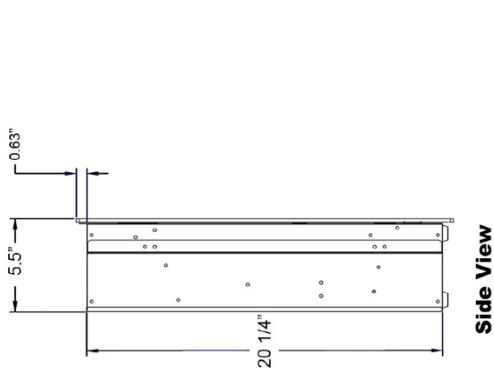

80025 - Sideline 45” Recessed Fireplace

Features

- 2 heat settings (high and low)
- Designed for recessed mounting in wall
- Remote control for heat and flame setting (batteries not included)
- Dual mode, operates with or without heat for only flame effect
- Built in timer mode for shut off in 30 minutes to 7.5 hours.
- Faux Fire Log and Glass Crystal Media Options

Specifications

- Frame color: Black
- Watts: 1500
- BTU's: 5000
- Room Coverage: 400 ft.
- Voltage: 120V
- Amps: 12
- Rough Opening: 40 1/8" W x 20 1/2" H x 5 3/4" D

Sideline 45” Recessed Fireplace
PN: 80025



PREMIUM
ELECTRIC FIREPLACES
& TV LIFTS

Exceeding Expectations

Updated: 12/23/2019

80027 – Sideline® 40” Dimensions

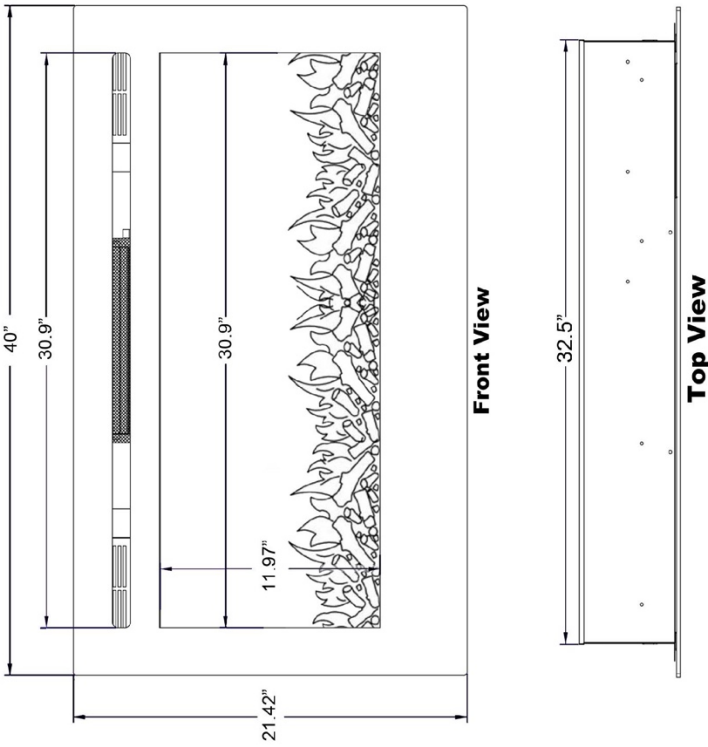
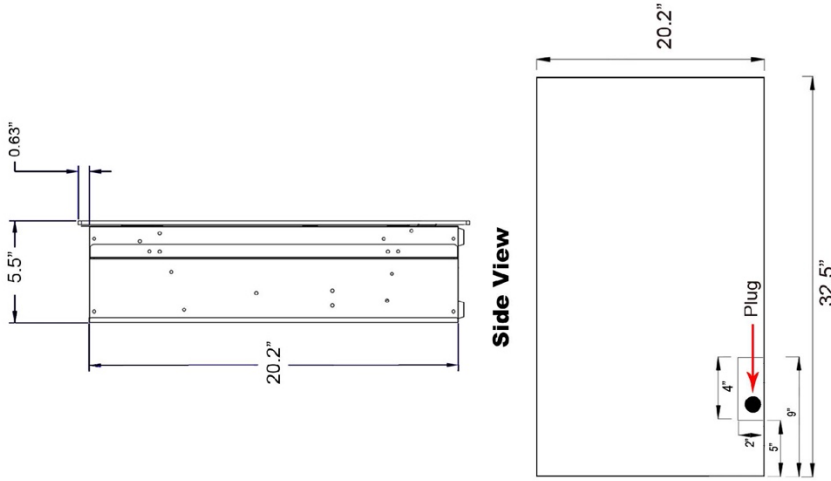

80027 - Sideline 40" Recessed Fireplace

Features

- 2 heat settings (high and low)
- Designed for recessed mounting in wall
- Remote control for heat and flame setting (batteries not included)
- Dual mode, operates with or without heat for only flame effect
- Built in timer mode for shut off in 30 minutes to 7.5 hours.
- Faux Fire Log and Glass Crystal Media Options

Specifications

- Frame color: Black
- Watts: 1500
- BTU's: 5000
- Room Coverage: 400 ft.
- Voltage: 120v
- Amps: 12
- Rough Opening: 32 3/4" W x 20 1/2" H x 5 3/4" D

Sideline 40" Recessed Fireplace
PN: 80027



**PREMIUM
ELECTRIC FIREPLACES
& TV LIFTS**
Exceeding Expectations

Updated: 04/17/2019

80028 – Sideline® 28” Dimensions

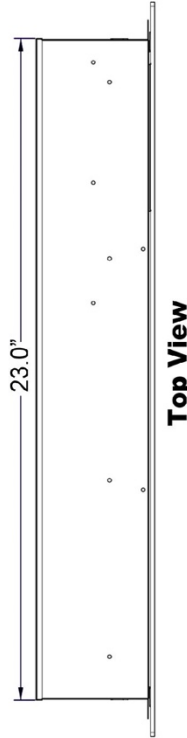
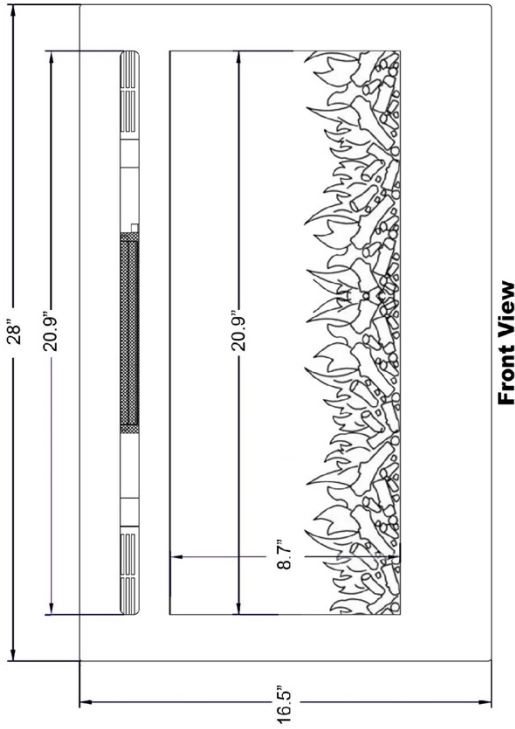
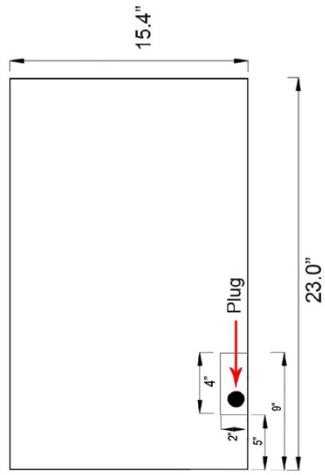
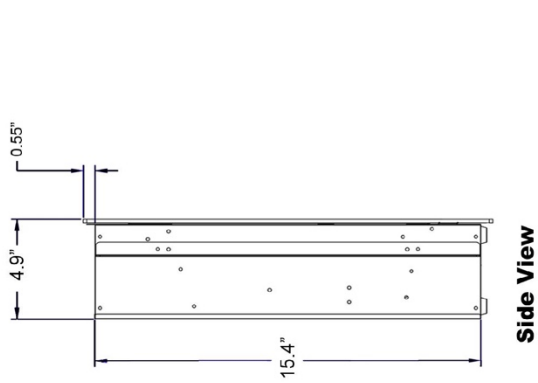

80028 - Sideline 28” Recessed Fireplace

Features

- 2 heat settings (high and low)
- Designed for recessed mounting in wall
- Remote control for heat and flame setting (batteries not included)
- Dual mode, operates with or without heat for only flame effect
- Built in timer mode for shut off in 30 minutes to 7.5 hours.
- Faux Fire Log and Glass Crystal Media Options

Specifications

- Frame color: Black
- Watts: 1500
- BTU's: 5000
- Room Coverage: 400 ft.
- Voltage: 120v
- Amps: 12
- Rough Opening Dimensions: 23 1/4"W x 15 3/4"H x 5 1/2"D

Sideline 28” Recessed Fireplace
PN: 80028



**PREMIUM
ELECTRIC FIREPLACES
& TV LIFTS**

Exceeding Expectations
Updated: 12/23/2019

80029 – Sideline® 50” White Dimensions

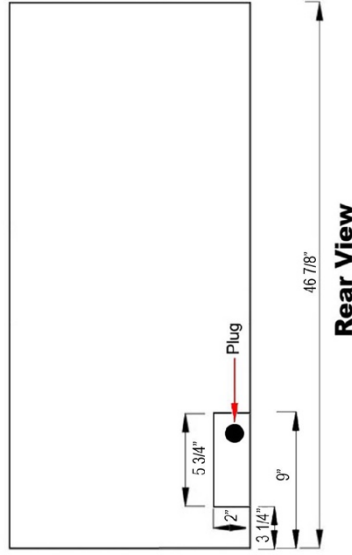
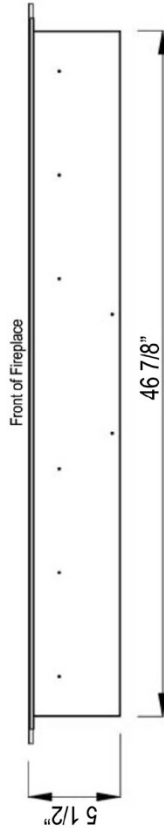
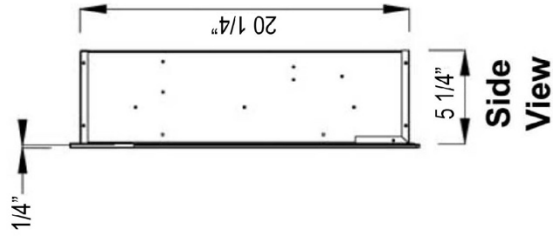
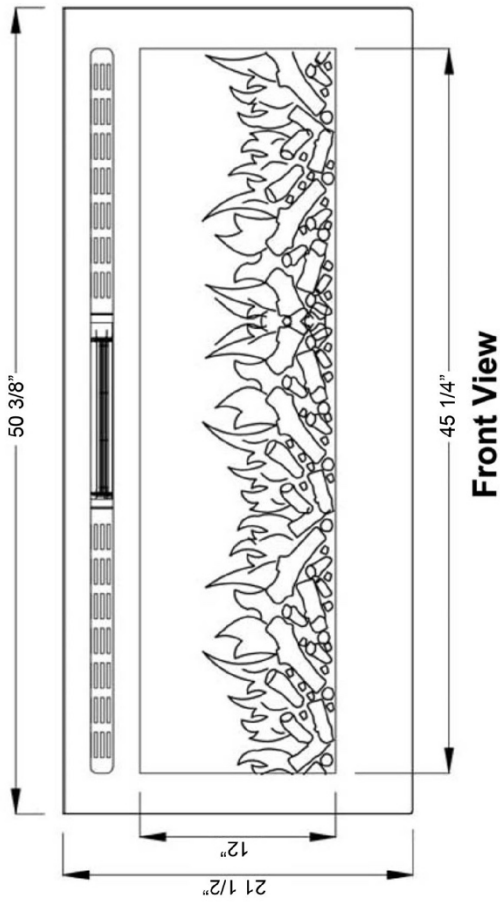

80004 - Sideline 50” Recessed Fireplace - Black 80029 - Sideline 50” Recessed Fireplace - White

Features

- 2 heat settings (high and low)
- Designed for recessed mounting in wall
- Remote control for heat and flame setting (batteries not included)
- Dual mode, operates with or without heat for only flame effect
- Built in timer mode for shut off in 30 minutes to 7.5 hours.
- Faux Fire Log and Glass Crystal Media Options

Specifications

- Frame color: 80004 - Black
80029 - White
- Watts: 1500
- BTUs: 5000
- Room Coverage: 400 ft.
- Voltage: 110v-120v
- Amps: 12
- Rough Opening: 47 1/8"W x 20 1/2"H x 5 3/4"W



**PREMIUM
ELECTRIC FIREPLACES
& TV LIFTS**

Exceeding Expectations
Updated: 12/23/2019

Sideline 50” Recessed Fireplace
PN: 80004/80029

80032 – Sideline® 100” Dimensions

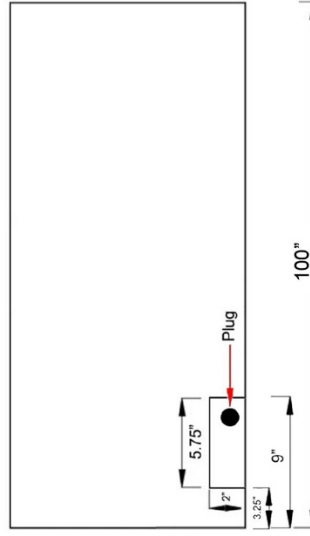
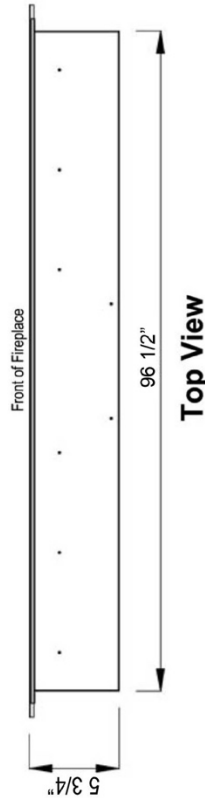
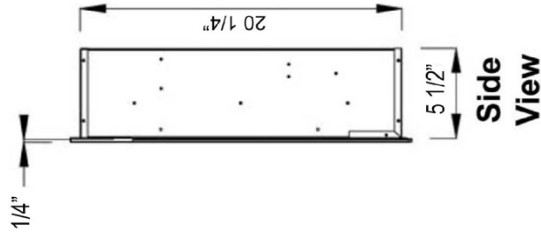
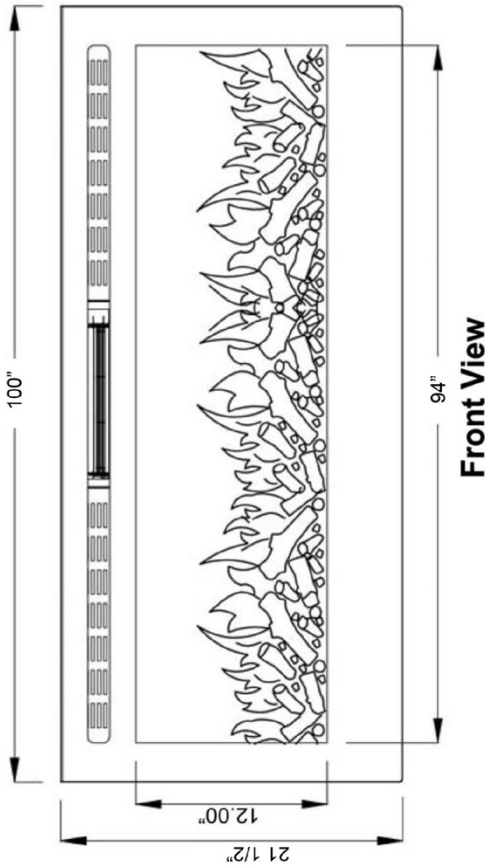

80032 - Sideline 100” Recessed Fireplace - Black

Features

- 2 heat settings (high and low)
- Designed for recessed mounting in wall
- Remote control for heat and flame setting (batteries not included)
- Dual mode, operates with or without heat for only flame effect
- Built in timer mode for shut off in 30 minutes to 7.5 hours.
- Faux Fire Log and Glass Crystal Media Options

Specifications

- Frame color: Black
- Watts: 1500
- BTU's: 5000
- Room Coverage: 400 ft.
- Voltage: 110v-120v
- Amps: 12
- Rough Opening: 96 3/4" W x 20 1/2" H x 5 3/4" D

Sideline 100” Recessed Fireplace
PN: 80032



PREMIUM
ELECTRIC FIREPLACES
& TV LIFTS

Exceeding Expectations

Updated: 12/23/2019

80043 – Sideline® 84” Dimensions

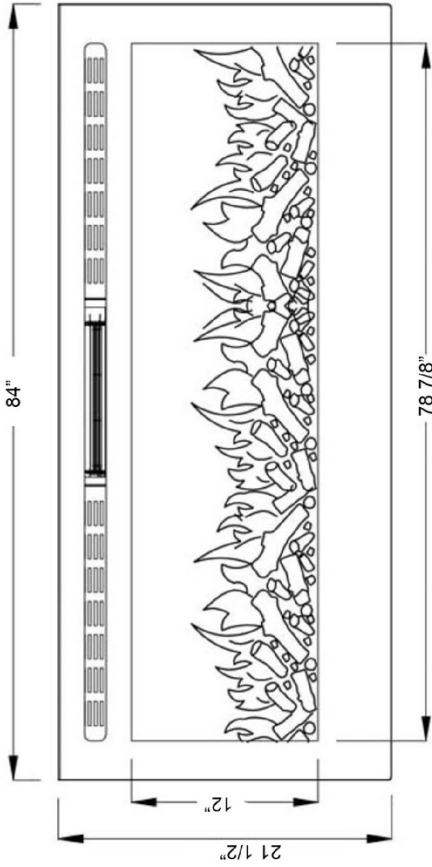

Front View

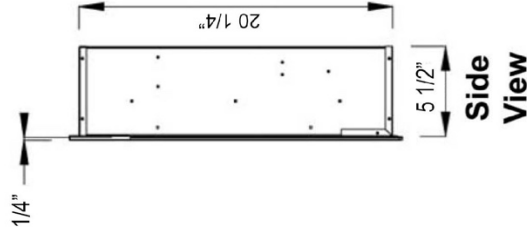

Side View

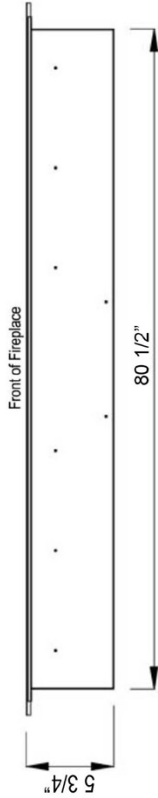

Top View

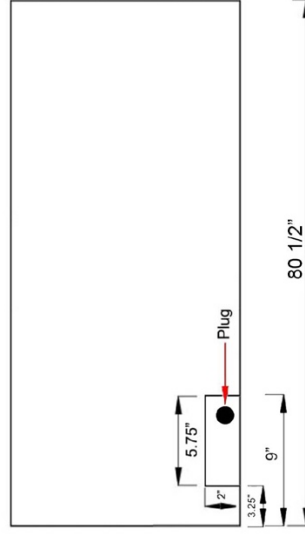

Rear View

80043 - Sideline 84” Recessed Fireplace - Black

Features

- 2 heat settings (high and low)
- Designed for recessed mounting in wall
- Remote control for heat and flame setting (batteries not included)
- Dual mode, operates with or without heat for only flame effect
- Built in timer mode for shut off in 30 minutes to 7.5 hours.
- Faux Fire Log and Glass Crystal Media Options

Specifications

- Frame color: Black
- Watts: 1500
- BTU's: 5000
- Room Coverage: 400 ft.
- Voltage: 110v-120v
- Amps: 12
- Rough Opening: 80 3/4" W x 20 1/2" H x 5 3/4" D

Sideline 84” Recessed Fireplace
PN: 80043



PREMIUM
ELECTRIC FIREPLACES
& TV LIFTS

Exceeding Expectations
Updated: 08/11/2020







Unpacking Your Fireplace

Parts and Hardware

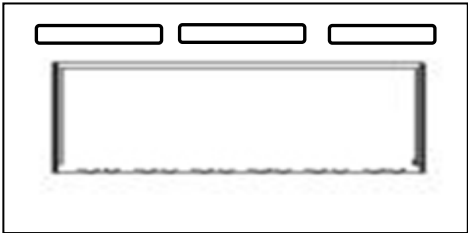
Tools Required

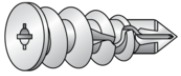
- Phillips screwdriver
- Stud finder
- Level
- Tape measure
- Electric drill
- 1/4" wood drill bit

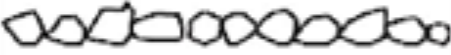
What's in the Box

 <p>Fireplace - 1</p>  <p>Wall Bracket - 1</p>	 <p>Wood Screws - 6</p>	 <p>Drywall anchors - 6</p>
	 <p>Remote Control - 1</p>	 <p>Metal Bracket - 2</p>
	 <p>Crystal Embers - 1 bag</p>	 <p>Plastic Tray - 1</p>
	 <p>Fire Log - 1</p>	

Unpacking and Setup

Remove all parts and hardware from the carton and place them on a clean, soft, dry surface. Check the parts list to make sure no parts are missing. If parts are missing, please contact technical support at 800-215-1990 for replacement parts.

NOTE: Dispose of plastic bag, as it may cause choking hazard with young children. Do not let children play with plastic bag.

Wiring

The Sideline® Series electric fireplace can either be plugged into a grounded 3-prong outlet or hard wire connection.

Testing the Fireplace Prior to Installation

- Before installing the fireplace, test the fireplace to make sure that it operates properly.
- Plug fireplace into approved outlet and power on fireplace. Once fireplace is tested, continue with installation.
- If you have any problems, please contact technical support at 800-215-1990.

3-prong Outlet Installation

- Only use this fireplace on a 120V AC, 15-Amp grounded circuit. Never overload the circuit. If this fireplace trips the circuit breaker, unplug all other appliances on the same circuit before the next use. Avoid plugging other appliances into the same circuit as this fireplace.
- Always check the fireplace plug and connections before each use.
- Never plug this fireplace into an outlet that is cracked or has any loose wires or connections. Plugging this fireplace into a faulty outlet could result in the outlet overheating or catching fire.
- Always plug this fireplace into a wall outlet or receptacle. Never plug this fireplace into a surge protector, extension cord, or relocatable power tap.
- Make sure this plug fits securely into the outlet. Faulty wall outlet connections or loose plugs can cause the outlet to overheat. If the outlet or faceplate is hot, discontinue use immediately and have a qualified electrician inspect and/or replace the faulty outlet.
- The power cord supplied with the heater has three prongs: two flat blades (live and neutral) and one round pin (ground). If a 3-slot receptacle is not available, an adapter **MUST** be used. The adapter **MUST** be properly grounded to the outlet box (see figure below).

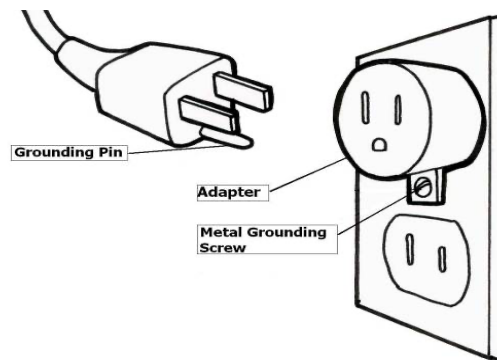

NOTE: Adapter NOT INCLUDED.

Hard Wire Connection

If it is necessary to hard wire this appliance, a qualified electrician must remove the cord connection, and wire the appliance directly to the household wiring.

This appliance must be electrically connected and grounded in accordance with local codes, if hard wired. In the absence of local codes, use the current ANSI/NFPA 70 NATIONAL ELECTRICAL CODE in the United States or the current CSA C22.1 CANADIAN ELECTRICAL CODE in Canada.

Fig. 1

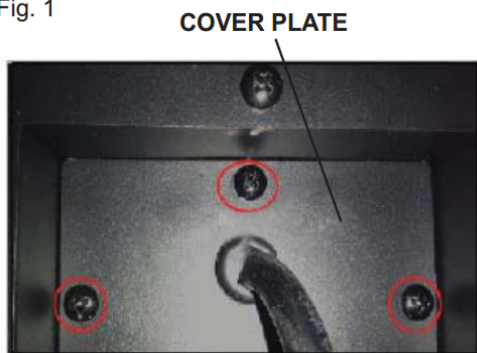
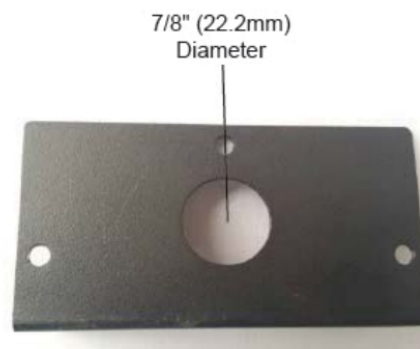
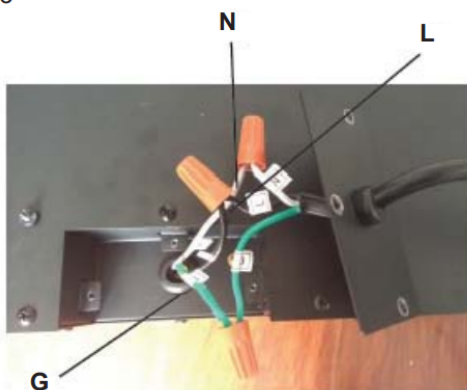

Fig. 2



- A. Remove the cover plate from the right side bottom of the appliance by removing the three screws, as shown above in Fig. 1. Save screws for installation of new cover plate.
- B. Remove the wire connectors from the power cord. Keep power cord, in case needed in future.
- C. Remove the power cable and wires from the cover plate. Thread your wiring through the hole in the cover plate for connecting to the wires in the fireplace.
- D. Using the wire connectors, connect the ground green wires (G) and the common white wires (N) together, and then connect the hot black wires (L) Refer to Figure 3 when complete.
- E. Reinstall the cover plate using the three screws, as shown in Figure 1.

Fig. 3



Installation

WARNINGS

- Due to high temperatures, keep the fireplace out of high traffic locations.
- Keep combustible materials, such as furniture, pillows, bedding, papers, clothes, and curtains at least 36" away from the front of the fireplace.
- Never install the fireplace where it may fall into a bathtub or other body of water.
- Wear safety gloves and safety glasses for protection during installation. Broken glass may cause injury or harm.
- Prevent contact with loose insulation. Do not install the fireplace against a vapor barrier or exposed insulation.
- Do not expose the fireplace to the elements, such as rain, snow, etc.

Choosing Installation Location

- Measure wall location to ensure that fireplace will fit on desired wall location.
- Minimum clearances (measurements taken from front of glass panel):

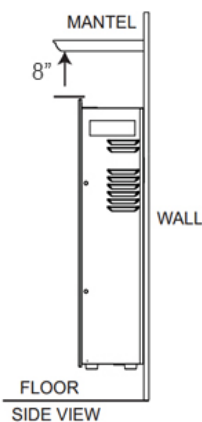

Bottom of Fireplace to Floor:	6"
Sides of Fireplace:	12"
Back of Fireplace:	0"
Top of Fireplace:	8" to mantel
Top of Fireplace:	8" to TV
Top of Fireplace:	8" to ceiling

- Select a location that is not prone to moisture and is located at least 36" away from combustible materials such as curtains, drapes, furniture, bedding.
- See Safety Information on p. 3 for warnings about safe placement, safe installation, and proper use of this product.

Removing Rubber Feet

- For in-wall, recessed installations, the rubber feet on the bottom of the fireplace are removable.
- Use a Philips-head screwdriver to remove the four rubber feet on the bottom of the fireplace as shown below.



Removing the Glass Panel

Remove the glass panel prior to installation. Please remove glass panel as per instructions below:

Instructions:

1. There are 2 screws in the top vent opening, one on the far left and one on the far right, that secure the left and right trim pieces in place. Remove both screws to remove the trim pieces.

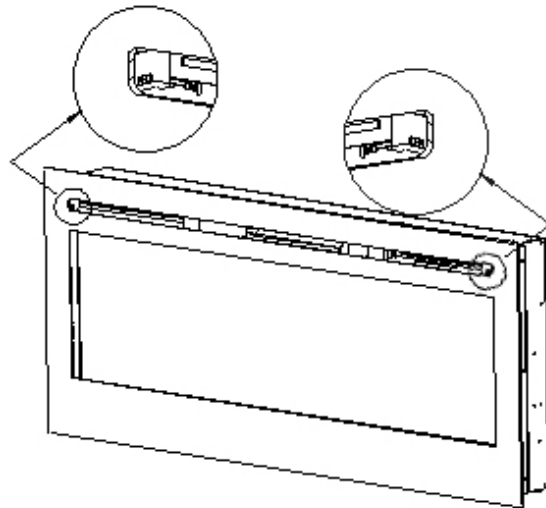

2. After removing screws, tilt glass panel UP and STRAIGHT OUT toward you to remove from fireplace. Place the glass panel in a soft, dry place.

CAUTION: It is recommended that 2 people remove the glass panel to minimize chance of breakage.

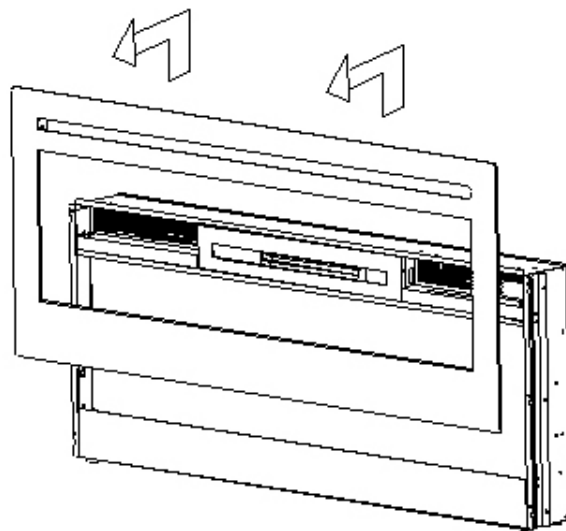

Recessed Installation

- Due to many different finish materials used on walls, it is highly recommended that you consult your local builder before you install this fireplace in the wall.
- Select a location that is not prone to moisture and is located at least 36" away from combustible materials such as curtains, drapes, furniture, bedding.
- To avoid the possibility of exposed insulation or vapor barrier coming in contact with the fireplace, it is recommended that the walls of the fireplace enclosure be "finished" (i.e. Sheetrock, drywall, etc.) as you would finish any other outside wall of your home. This will ensure that clearance to combustibles is maintained within the wall cavity.
- Never install fireplace into load-bearing walls. When recessing fireplace in a wall, recess into non-load bearing walls ONLY!

Instructions:

1. Choose a location in the wall to install fireplace.
2. Create opening in the wall that is no more than $\frac{1}{4}$ " larger than metal firebox portion of fireplace. Refer to the firebox and rough opening dimensions below.

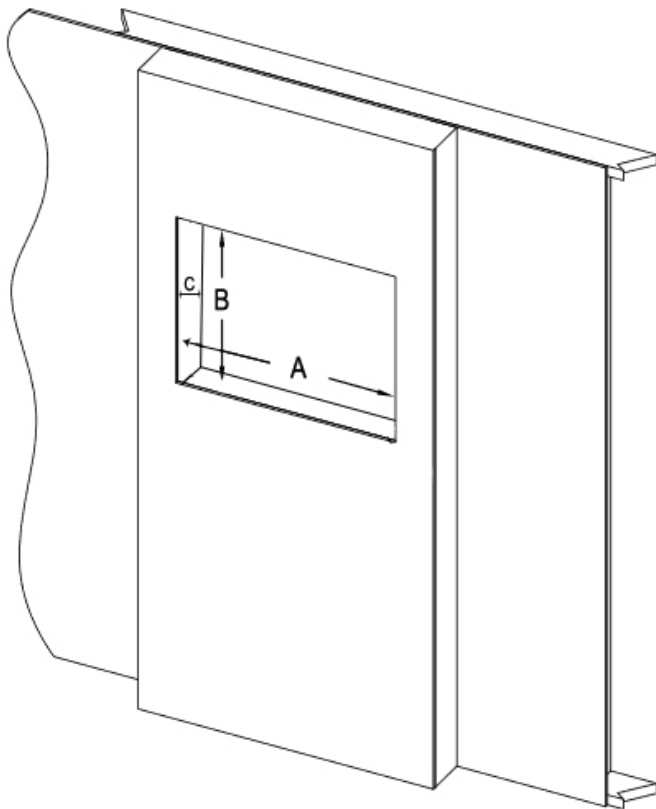

Recessed Installation – continued

Firebox Dimensions

Model	Width	Height	Depth
80004	46 7/8"	20 1/4"	5 1/4"
80011	46 7/8"	20 1/4"	5 1/4"
80014	32 1/2"	20 1/4"	5 1/4"
80015	68 3/8"	20 1/4"	5 1/4"
80025	39 7/8"	20 1/4"	5 1/4"
80027	32 1/2"	20 1/4"	5 1/4"
80028	23"	15 1/2"	5"
80029	46 7/8"	20 1/4"	5 1/4"
80032	96 1/2"	20 1/4"	5 1/4"
80043	80 1/2"	20 1/4"	5 1/4"

Rough Opening Dimensions

Model	A (Width)	B (Height)	C (Depth)
80004	47 1/8"	20 1/2"	5 3/4"
80011	47 1/8"	20 1/2"	5 3/4"
80014	32 3/4"	20 1/2"	5 3/4"
80015	68 7/8"	20 1/2"	5 3/4"
80025	40 1/8"	20 1/2"	5 3/4"
80027	32 3/4"	20 1/2"	5 3/4"
80028	23 1/4"	15 3/4"	5 1/2"
80029	47 1/8"	20 1/2"	5 3/4"
80032	96 3/4"	20 1/2"	5 3/4"
80043	80 3/4"	20 1/2"	5 3/4"

Recessed Installation – continued

3. With the help of a second person, insert fireplace into wall opening and secure with the provided mounting screws.

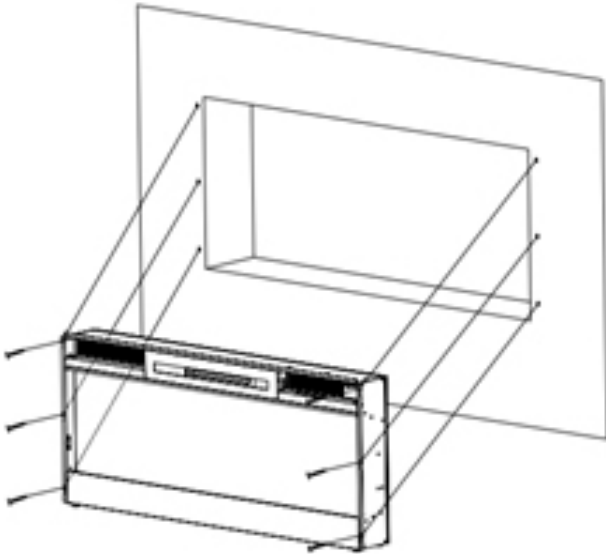

4. Once the fireplace is installed in the wall, place crystal embers or fire log in the fireplace.

Crystal Embers and Fire Log Installation

Crystal Ember Installation

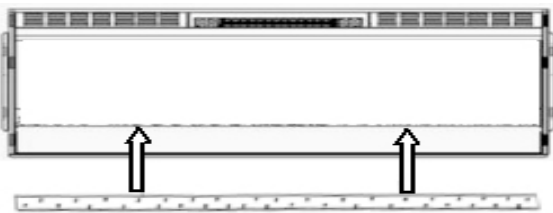

1. Place plastic tray strip in fireplace above the LED lights as shown in the diagram above.



2. Carefully place crystal embers on plastic strip as illustrated above. Apply an even layer from side to side.

Fire Log Installation



3. Place the fire log in fireplace as shown above.

Re-installing the Glass Panel

Once you have installed the crystal embers or fire log, you are ready to reinstall the glass panel

The hooks on the back of the glass panels fit into the slots on the side of the firebox. Once fitted in the slots, the glass panel goes down and locks into place. Once in place, reinstall 2 locking screws to hold glass securely in place.

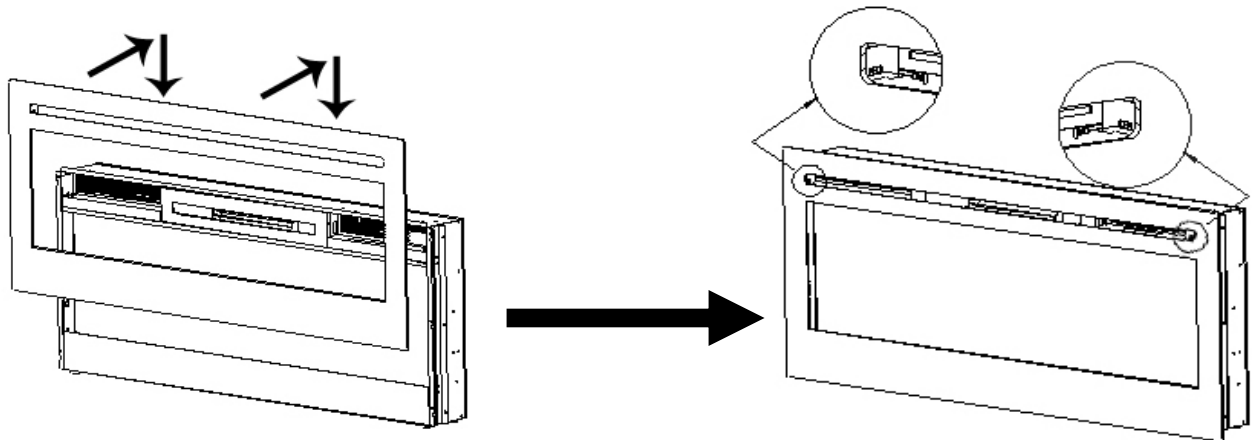

Wall Mounted Installation

- Due to many different finish materials used on walls, it is highly recommended that you consult your local builder before you install this fireplace on the wall.
- Select a location that is not prone to moisture and is located at least 36" away from combustible materials such as curtains, drapes, furniture, bedding.

Instructions

1. Select a location that is not prone to moisture and is located at least 36" away from combustible materials, such as curtains, drapes, furniture, bedding, paper, etc.
2. With glass panel removed (see instructions on removing the glass panel in previous section), have two people hold the fireplace against the wall to determine the final location.
3. Place the unit face down on a soft, non-abrasive surface. Remove the bracket from the back of the unit by removing the screws holding the bracket to the back of the fireplace.

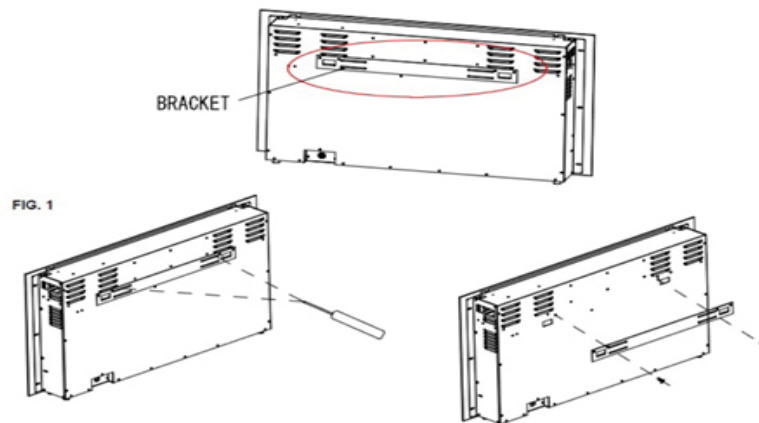

Wall Bracket Removal (1 bracket)

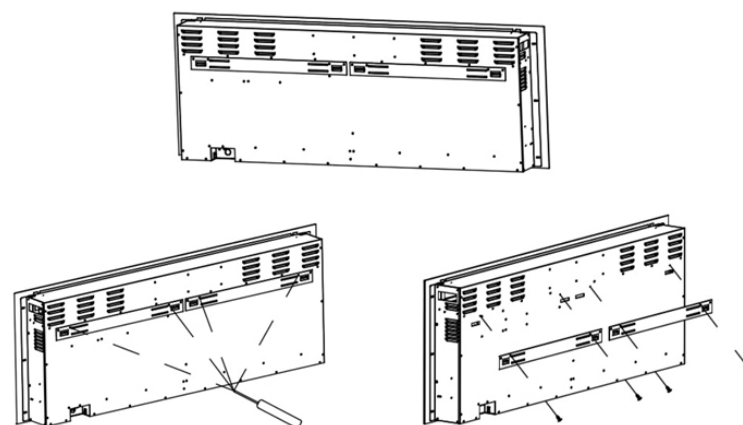

Wall Bracket Removal (2 brackets)

Wall Mounted Installation – continued

4. Mark location of bracket on wall and then mount the bracket to the wall using the supplied screws and dry wall anchors. The hooks in the bracket **MUST** be pointed away from the wall, upward, and level.

Note: Mount bracket to at least 2 studs. If 2 studs cannot be used, ensure that the supplied dry wall anchors are used to affix the bracket to the wall and the bracket is adequately secured before moving to the next step.

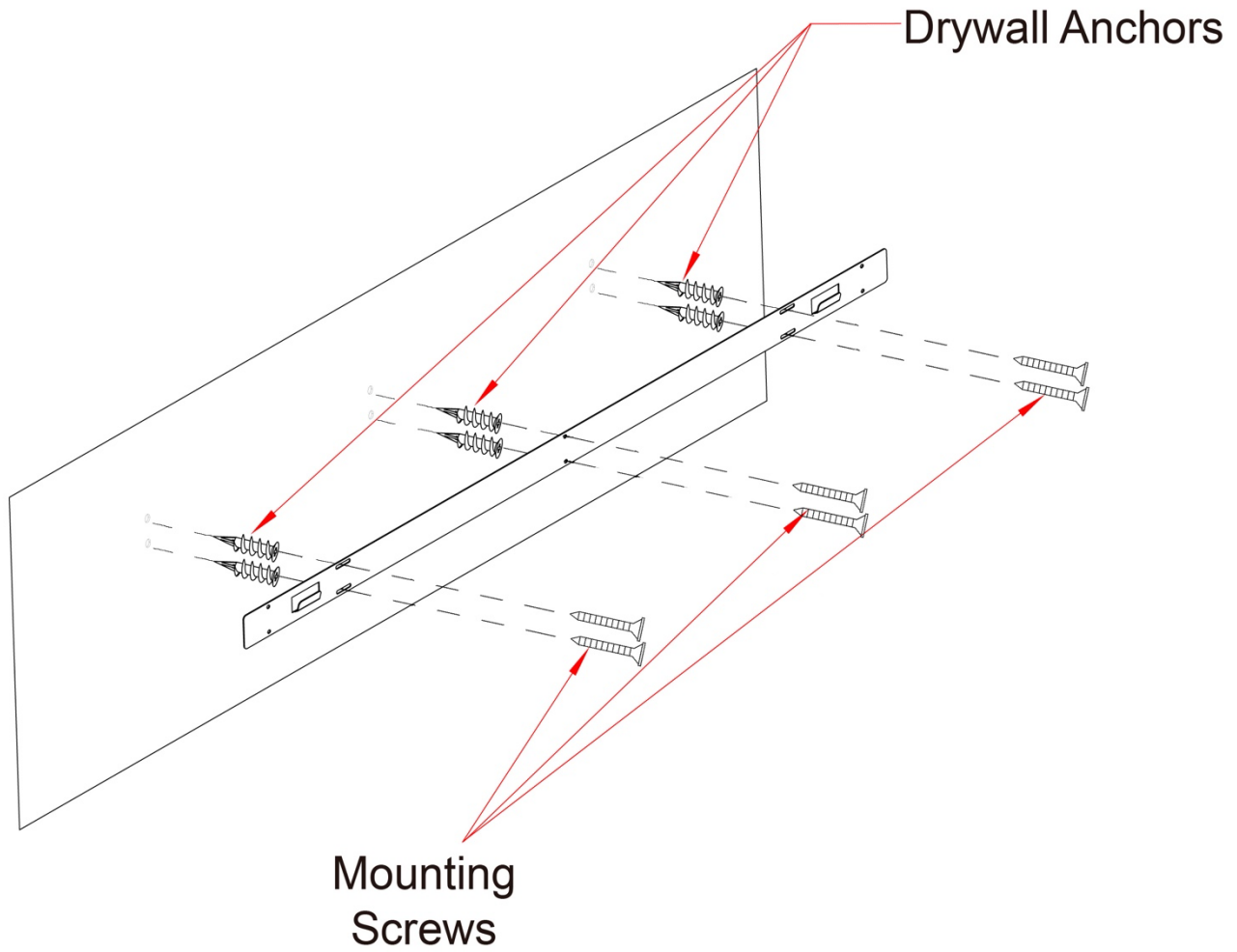

Wall Mounted Installation – continued

5. With the wall mounting bracket installed, have 2 people lift the fireplace up and insert the 2 hooks on the bracket into the back of the fireplace. The 2 hooks on the mounting bracket will line up with the 2 holes on the back of the fireplace. Once aligned, the hooks will insert into the holes in the back of the fireplace and lock in the down position.

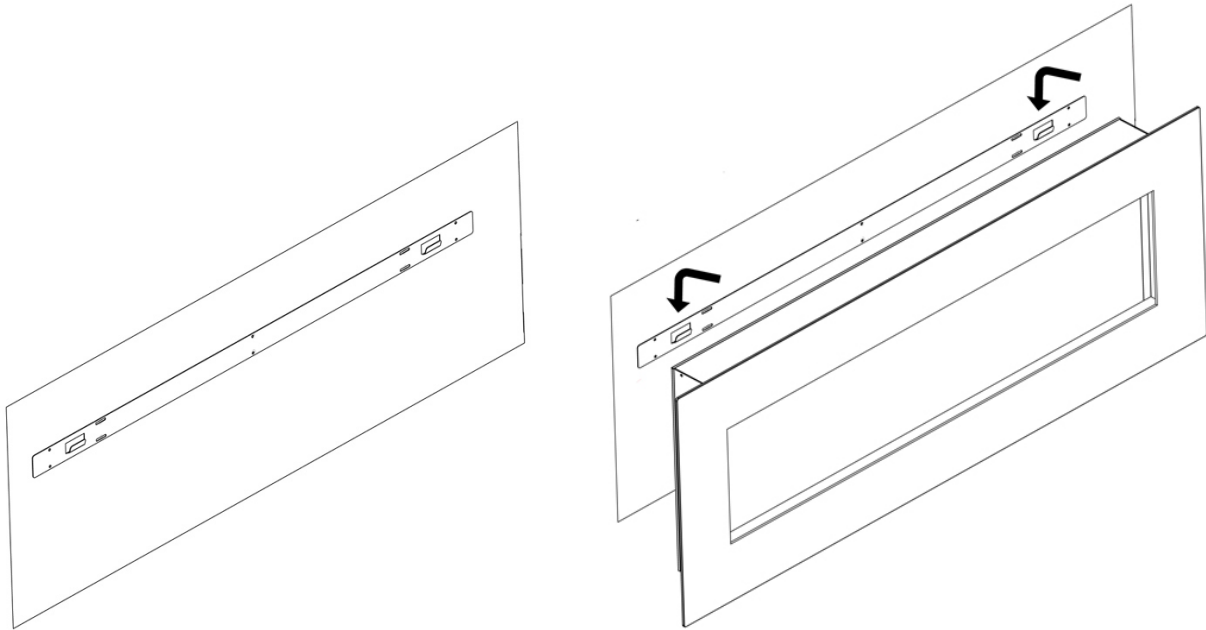

Mounting bracket installed on wall

Hang fireplace on mounting bracket hooks

6. Check the fireplace for stability, ensuring that the bracket will not pull free from the wall. Once satisfied, install crystal embers/fire log and reinstall glass panel.

Operating the Fireplace

Once the fireplace has been plugged into a grounded outlet, the fireplace is now ready for operation. Ensure that the house circuit breakers for the power supply are turned on.





Power

Plug the power cable into a 110v 15 amp grounded outlet. Make sure the outlet is in good condition and that the plug is not loose. NEVER exceed the maximum amperage for the circuit. DO NOT plug other appliances into the same circuit.

Always plug this fireplace into a wall outlet or receptacle. Never plug this fireplace into a surge protector, extension cord, or relocatable power tap.

Methods of Operation

This electric fireplace can be operated by the CONTROL PANEL, located in the upper righthand corner of the fireplace, or by the REMOTE CONTROL. The operation and functions of both methods are the same.

BUTTON	FUNCTION	ACTION & INDICATION
 POWER	<p>ON: Enables control panel functions and remote control. Turns on the flame effect.</p> <p>OFF: Disables control panel functions and remote control. Turns off the flame effect.</p>	<p>1. Press once. Indicator light turns on. Power turns on. All functions enabled.</p> <p>2. Press again. Flame effect turns off. Unit goes to standby. All functions turn off.</p>
 TIMER	<p>TIMER button: Control time settings to turn off fireplace at selected time.</p> <p>Settings range from 0.5 hours to 7.5 hours.</p>	<p>1. Press once. Indicator light turns on. Timer is set to 0.5 hours.</p> <p>2. Press again until desired setting is reached. Indicator lights show setting.</p>
 FLAME	<p>FLAME button: Makes flame effects dimmer or brighter.</p> <p>NOTE: Flame effect stays on until power button is turned off. Flame effect must be on for heater to turn on.</p>	<p>1. Press once to change the flame brightness.</p> <p>2. Press again until desired setting is reached.</p>
 COLOR	<p>COLOR button: Changes the color of the flame.</p>	<p>1. Press once to change the color of the flame.</p> <p>2. Press again until desired setting is reached.</p>

	<p>HEATER button: Turns heater on and off.</p> <p>NOTE: The heater only works when the flame effect is on.</p> <p>NOTE: To prevent overheating, the heater fan will blow cool air for 8-10 seconds before the heater turns on, and after the heater turns off.</p>	<p>1. Press once. Indicator lights up. Fan blows cool air for 10 seconds and 750W heater turns on and blows warm air.</p> <p>2. Press again: Indicator lights up. 1500W heater turns on and blows hot air.</p> <p>3. Press again. Heater turns off.</p>
---	---	--

Remote Control Operation

- This remote control uses 2 AAA batteries (not included).
- Instructions for battery installation are located on the remote control battery compartment door.
- To improve operation of the remote control, aim the remote control at the front of the fireplace. DO NOT PRESS the buttons too quickly. Give the unit time to respond to each command.
- NOTICE: NEVER dispose of batteries in fire. Failure to observe this precaution may result in an explosion. Dispose of batteries at your local hazardous material processing center.

Temperature Limiting Control

This heater is equipped with a Temperature Limiting Control. Should the heater reach an unsafe temperature, the heater will automatically TURN OFF. To reset, please do the following:

1. Unplug the power cord from the outlet.
2. Turn ON/OFF switch on the CONTROL PANEL to OFF. Wait 5 minutes for fireplace to cool down.
3. Inspect the fireplace to make sure no vents are blocked or clogged with dust or lint. If they are, use a vacuum to clean the vent areas.
4. With the POWER switch in the OFF position, plug the power cord back into the outlet.
5. If the problem continues, have your outlet and wiring inspected by a professional. If the outlet is OK, please contact our customer support department at 800-215-1990.

Care, Cleaning and Maintenance

Cleaning

ALWAYS turn the heater OFF and unplug the power cord from the outlet before cleaning, performing maintenance, or moving the fireplace. Failure to do so could result in electric shock, fire, or personal injury.

NEVER immerse in water or spray with water. Doing so could result in electric shock, fire, or personal injury.

Metal:

Buff using a soft cloth, slightly dampened with citrus oil-based product.

DO NOT use brass polish or household cleaners, as these products will damage the metal trim.

Glass:

Use a good quality glass cleaner sprayed onto a cloth or towel. Dry thoroughly with a paper towel or lint-free cloth. NEVER use abrasive cleansers, liquid sprays, or any cleaner that could scratch the surface.

Vents:

Use a vacuum or duster to remove dust and dirt from the heater and vent areas.

Plastic:

Wipe gently with a slightly damp cloth and a mild solution of dish soap and warm water.

NEVER use abrasive cleansers, liquid sprays, or any cleaner that could scratch the surface.

Maintenance

- RISK OF ELECTRIC SHOCK! DO NOT OPEN any panels. No user-serviceable parts inside!
- ALWAYS turn the heater OFF and unplug the power cord from the outlet before cleaning, performing maintenance, or moving the fireplace. Failure to do so could result in electric shock, fire, or personal injury.

Electrical and Moving Parts:

- The fan motors are lubricated at the factory and will not require lubrication.
- Electrical components are integrated in the fireplace and are not serviceable by the customer.

Storage:

- Store fireplace in a clean, dry place when not in use.

Warranty

Touchstone Home Products® , Inc. warrants our electric fireplaces to be free of defects in material and workmanship for one year from date of purchase. Touchstone Home Products® will repair or replace any fireplace or fireplace part that is deemed defective or becomes defective during normal use within one year after the date of purchase.

Electrical components, such as fan motor, heater motor, control board, remote control, and control panel are covered under warranty for one year from date of purchase. Touchstone Home Products® will provide replacement parts free of charge during the first year of the warranty.

Replacement parts and fireplace units are covered under a 90-day warranty or the remainder of the original one-year manufacturer's warranty from original date of purchase, whichever is greater.

Touchstone Home Products® , Inc. does not warrant its products against damage caused by third parties.

Touchstone Home Products® , Inc. does not cover damages caused by misuse, alterations, accident, lack of maintenance, abuse or neglect. Parts installed from other manufacturers will void this warranty.

The warranty does not cover paint scratches, cosmetic blemishes, dents, corrosion, or other normal wear and tear associated with the fireplace. Damage to fireplace or other components due to water, weather damage, long periods of dampness, condensation, damaging chemicals or cleaners are not covered under warranty.

This warranty does not cover breakage of fireplace glass panel.

Touchstone Home Products® , Inc. will not be responsible for installation, labor, or any other expenses related to the reinstallation of a warranted part, and such expenses are not covered under warranty.

Extended warranty coverage for the fireplace is available by contacting Touchstone Home Products® directly at 1-800-215-1990.



CALL US FIRST!



DO NOT RETURN TO STORE.

For immediate help with assembly, product information,
or if your product arrives damaged, call our toll-free number at



800-215-1990

or email:

customerservice@thpus.com

Our staff is ready to provide assistance.

Affix Serial Number Label Here

 WARNING	Read and understand this entire owner's manual, including all safety information, <u>before</u> plugging in or using this product. Failure to do so could result in fire, electric shock, or serious personal injury.
 CAUTION	Keep this owner's manual for future reference. If you sell or give this product away, make sure this manual accompanies this product.