

POP-A-SHOT®

POP-UP

ASSEMBLY INSTRUCTIONS



Model: PASPUG22 REV 6/21/22



support@popashot.net



www.popashot.net

The Fine Print

Warranty

As described in and as limited by this Warranty, Pop-A-Shot Enterprise, LLC (the "Company") warrants this product to be free from defects in workmanship and materials for a period of 90 days from the date of original purchase. The term defects shall mean any imperfections that impair the use of the product. The company reserves the right to request confirmation of proof of purchase when requesting parts or service in order to confirm that this product is within its warranty period and terms.

What is Covered:

Just about everything, but mainly defects in materials and workmanship. This warranty is void if the product is:

- Damaged through improper usage or storage, negligence, misuse, abuse, transportation damage, acts of nature, or accident (including failure to follow the instructions supplied with the product).
- Used in commercial applications, rentals or a commercial environment.
- Modified or repaired by anyone not authorized by the company.

What the Company Will Pay For:

- If any part or component of the product which is covered by this warranty is found by the company to be defective, the company will provide replacement parts without charge. The company's obligation to repair or replace the product or any portion of thereof, shall be limited to the original purchase price of the product.
- If during the warranty period, the product is found to be defective, the company will, at the company's option, repair, replace or make remuneration for the product (either the same or equivalent value) without charge.

To Obtain Warranty Service:

- You must return the original copy of your sales receipt to the company showing a purchase from an authorized retailer.
- You must email the company's customer service department at support@popashot.net to notify the company of the nature of the problem. Customer service is available Monday through Friday between the hours of 8:00am and 5:00 P.M. CST. At the company's option, replacement parts or a new product (either the same or equivalent value) will be sent to you at no charge.
- If you are instructed to return the product to the company for servicing, you are responsible for shipping the product, at your expense, to the address designated by the company in packaging that will protect against further damage.
- You must also include your name, address, daytime telephone number, product model number, and a description of the problem.
- The company will pay for any shipping charges to return the repaired or replaced product to you.

This warranty gives you specific legal rights, but you may also have other rights that vary from state to state.

If you have questions regarding this warranty or the operation of the product, please email us at support@popashot.net.

Some Warnings



This is not a toy. It is Intended for use by or under the supervision of adults. Review all safety guidelines with children to avoid risk of electric shock or other injuries.



No children or pets in assembly area.
CHOKING HAZARD
This item contains small parts. Not suitable for children under 3 years old.



Do not store game outdoors. Game is not designed to play in rain. Wet conditions will affect gameplay, appearance and longevity as well as void warranty.



Do not sit, stand, lean in to, or lean on your finished Pop-A-Shot.

STOP

PLEASE READ THIS PAGE

STOP

It'll only take a minute and will save you time!

BEFORE PUTTING TOGETHER YOUR GAME

We strongly recommend scanning the QR code here (or going to www.popashot.net/qr-pug) to visit the Pop-Up Game Hub. Here you'll find a wealth of resources to get the most out of your game, including:

- 🏀 Registration form. Complete the form and your warranty will be extended an additional 90 days (so you'll be covered for 6 months).
- 🏀 Assembly directions, videos and additional tips.
- 🏀 Troubleshooting help, both for assembling as well as playing your game.
- 🏀 The easiest way to contact our All-Star Support team with any questions.
- 🏀 Links to our social media channels (make sure to follow us!).
- 🏀 The Century Club, for those whose scores have hit 3 digits!



DURING ASSEMBLY

Now that you're ready to begin putting together your game, here are a few tips:

- 🏀 Remove all of the parts from the box and verify that you have all of them (as shown on the Parts list on pages 4-5). Keep an eye out for some of the smaller ones, like the rim nets.
- 🏀 Find a clean, level place to assemble your game.
- 🏀 We recommend working on a soft, non-marring surface such as carpet or the cardboard box your game came in.
- 🏀 Like most things in life, putting together a Pop-A-Shot is better with a friend. If you can't find someone to help the entire time, we'll point out those steps when two people are especially helpful.









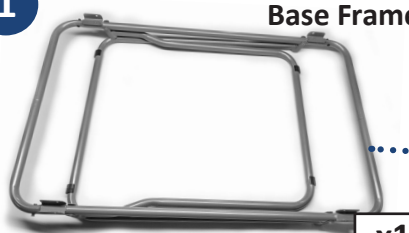
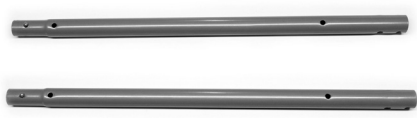

If you do have any problems or questions during assembly or operation, please email support@popashot.net and we will take care of them.

WHEN YOU'RE DONE

- 🏀 Please leave a review on Amazon or popashot.net and let others know how you like your game.
- 🏀 Share a video or photo of your home court. Tag us [@popashot](https://www.instagram.com/popashot) on Instagram to be entered to win a T-shirt.

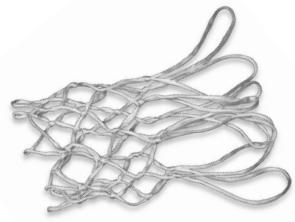
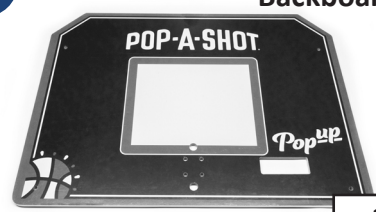

POP-UP PARTS

<p>Instruction Part ID#</p> <p>Part #</p> <p>Step Used In</p>	<p>1</p> <p>Base Frame</p>  <p>PUG001</p> <p>x1</p> <p>STEPS 1 & 5</p>	<p>Part Name</p> <p>Part Image</p> <p>Part Quantity</p>	<p>2</p> <p>Backboard Brace</p>  <p>PUG002</p> <p>x2</p> <p>STEPS 3, 4 & 9</p>
<p>3</p> <p>Rear Brace Arm Left & Right</p>  <p>PUG003R & L</p> <p>x2</p> <p>STEPS 2 & 3</p>	<p>4</p> <p>Top Tube Left & Right</p>  <p>PUG004R & L</p> <p>x2</p> <p>STEPS 4 & 10</p>	<p>5</p> <p>Rear Cross Tube</p>  <p>PUG005</p> <p>x1</p> <p>STEP 3</p>	
<p>6</p> <p>Front Arm Tube Left & Right</p>  <p>PUG006R & L</p> <p>x2</p> <p>STEPS 5 & 6</p>	<p>7</p> <p>Lean Bar</p>  <p>PUG007</p> <p>x1</p> <p>STEP 6</p>	<p>8</p> <p>Rim</p>  <p>PUG321</p> <p>x1</p> <p>STEP 7</p>	
<p>9</p> <p>Net</p>  <p>HHH331</p> <p>x1</p> <p>STEP 7</p>	<p>10</p> <p>Backboard</p>  <p>PUG371</p> <p>x1</p> <p>STEPS 7, 8, 9 & 10</p>	<p>11</p> <p>Ball Return Ramp</p>  <p>PUG018</p> <p>x1</p> <p>STEPS 10 & 11</p>	
<p>12</p> <p>Front Cross Tube</p>  <p>PUG012</p> <p>x1</p> <p>STEP 11</p>	<p>13</p> <p>Scoreboard</p>  <p>PUG204</p> <p>x1</p> <p>STEP 8</p>	<p>14</p> <p>Sensor</p>  <p>HHH202</p> <p>x2</p> <p>STEP 8</p>	

POP-UP HARDWARE & ACCESSORIES

15 Long Bolt

 PUG025 **x6**
STEPS 2, 3, & 5

16 Short Bolt

 PUG026 **x4**
STEP 7

17 Washer

 PUG029 **x30**
STEPS 2, 3, 5, 7, 9, 10 & 11

18 Nut

 PUG030 **x14**
STEPS 2, 3, 5, 7, 9, 10 & 11

19 Small Screw

 PUG019 **x4**
STEP 8

20 Backboard Brace Pin

 PUG020 **x2**
STEP 3

21 Wrench

 PUG031 **x1**

22 Allen Wrench

 PUG033 **x1**

23 Air Pump

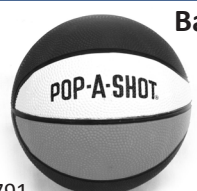
 PAS340 **x1**
 NOTE: The needle is in the handle of the pump

24 Basketball

 Z7-YK48-S791 **x3**

25 Medium Screw

 PUG027 **x4**
STEP 8

26 Travel Bag

 PUG382 **x1**

27 Medium Bolt

 PUG024 **x2**
STEP 11

28 Extra Long Bolt

 PUG028 **x4**
STEPS 9 & 10

The included tools will get the job done, but you probably have better tools of your own.

CAUTION: DO NOT OVER TIGHTEN.
 SET TO VERY LOW TORQUE when using Electric Screwdriver or Power Driver.

INCLUDED TOOLS

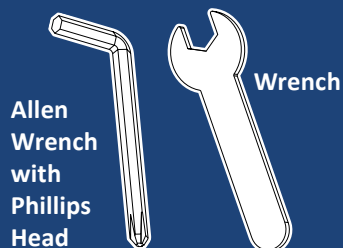

RECOMMENDED TOOLS

Socket Wrench Set, Power Driver or Electric Screwdriver

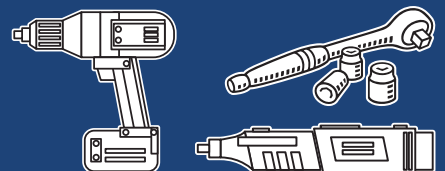

POP-A-SHOT

STEP 1

ID#	Name	Qty.
1	Base Frame	x1

Unfold the legs of the (#1) Base Frame and fully extend them until the frame can stand on its own. The legs that bow inward should be in the front.

FRONT

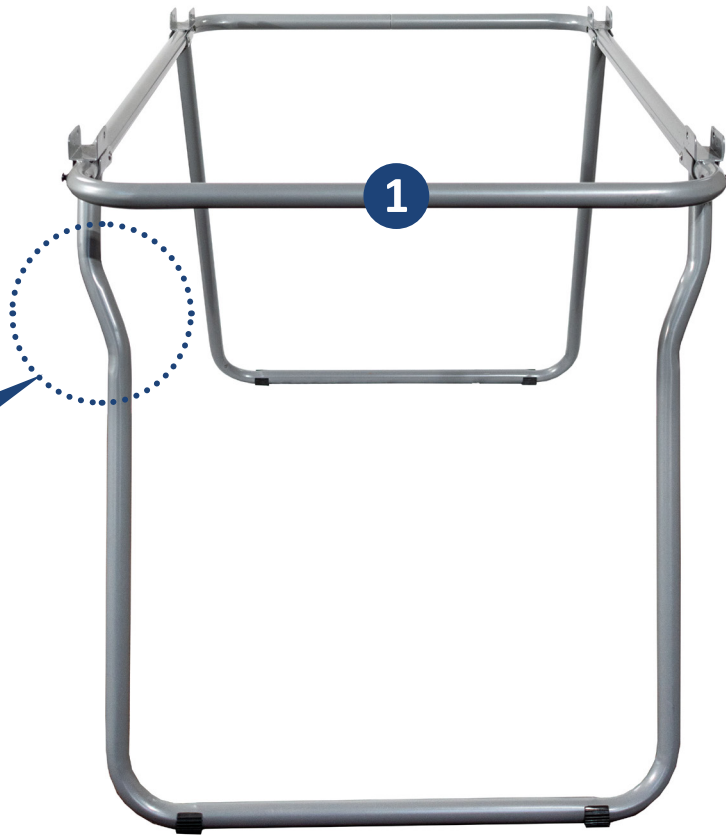

STEP 2

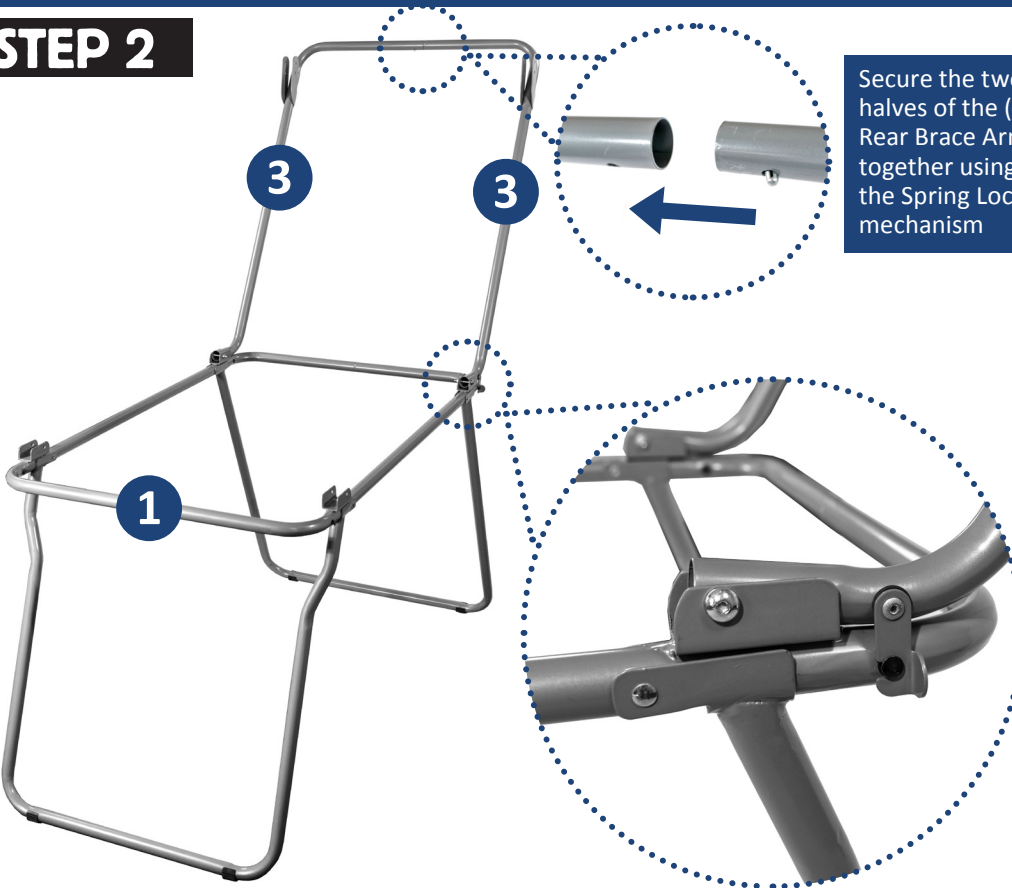

Secure the two halves of the (#3) Rear Brace Arm together using the Spring Lock mechanism

ID#	Name	Qty.
1	Base Frame	x1
3	Rear Brace Arm <i>Left & Right</i>	x2
15	Long Bolt	x2
17	Washer	x4
18	Nut	x2

Then attach the (#3) Rear Brace Arm to the (#1) Base Frame using a (#15) Long Bolt, one (#17) Washer on each side & (#18) Nut. Stabilize by latching the gray clips on the side of (#3) Rear Brace Arms to the (#1) Base Frame.

POP-A-SHOT

STEP 3

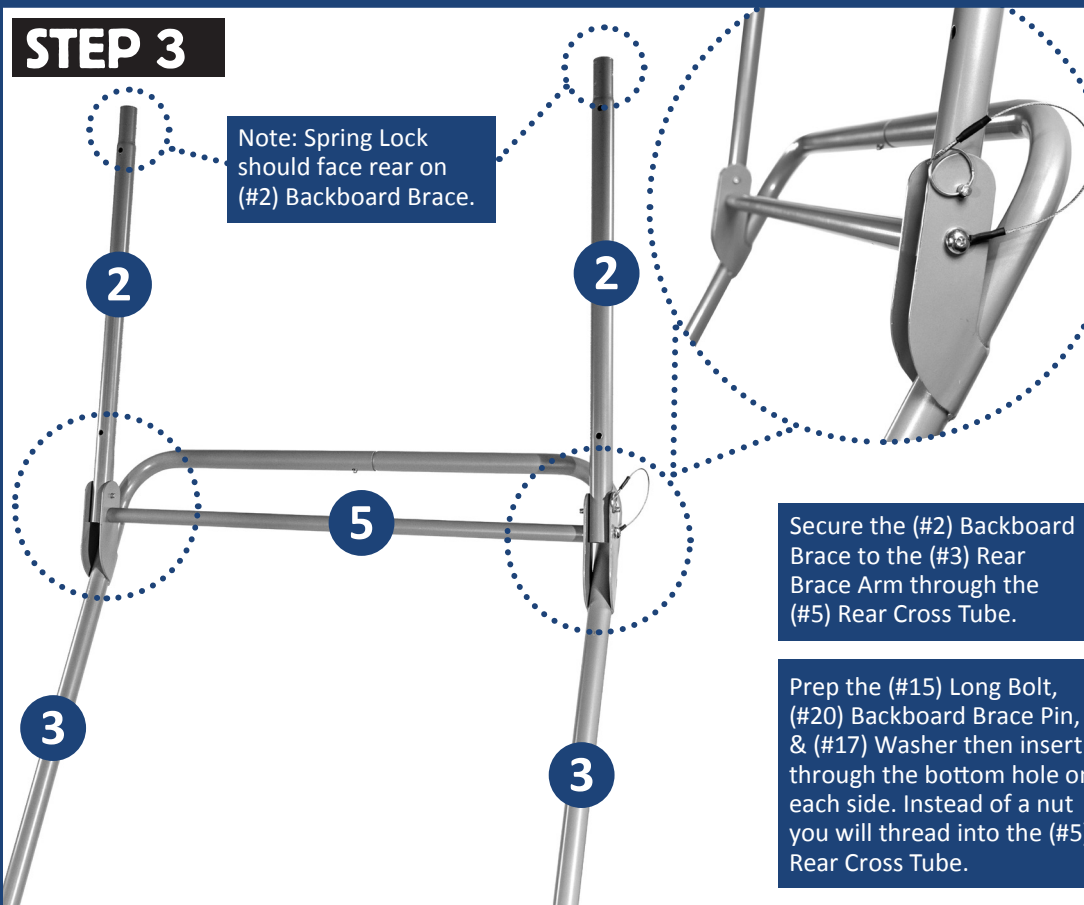

ID#	Name	Qty.
2	Backboard Brace	x2
3	Rear Brace Arm <i>Left & Right</i>	x2
5	Rear Cross Tube	x1
15	Long Bolt	x2
17	Washer	x2
20	Backboard Brace Pin	x2

STEP 4

ID#	Name	Qty.
2	Backboard Brace	x2
4	Top Tube <i>Left & Right</i>	x2

Attach each (#4) Top Tube to each vertical (#2) Backboard Brace piece using the Spring Lock mechanism.

Note: The holes on the inside of each of the (#4) Top Tubes should both face in toward each other.

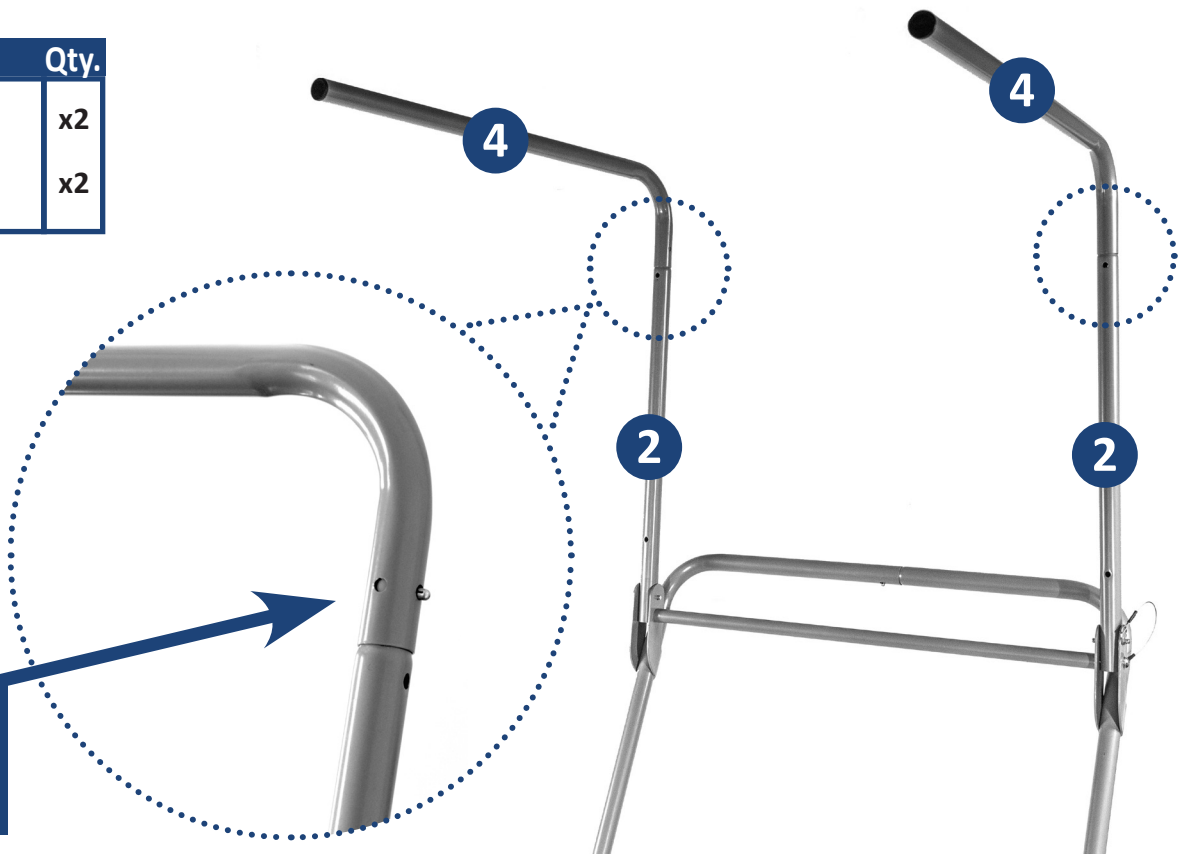

POP-A-SHOT

STEP 5

ID#	Name	Qty.
1	Base Frame	x1
6	Front Arm Tube <i>Left & Right</i>	x2
15	Long Bolt	x2
17	Washer	x4
18	Nut	x2

Attach the (#6) Front Arm Tube to the front of the (#1) Base Frame using a (#15) Long Bolt, one (#17) Washer on each side & (#18) Nut. Both tubes should narrow toward the center of the game when attached properly. Stabilize by latching the gray clips on the side of (#6) Front Arm Tube to the (#1) Base Frame.

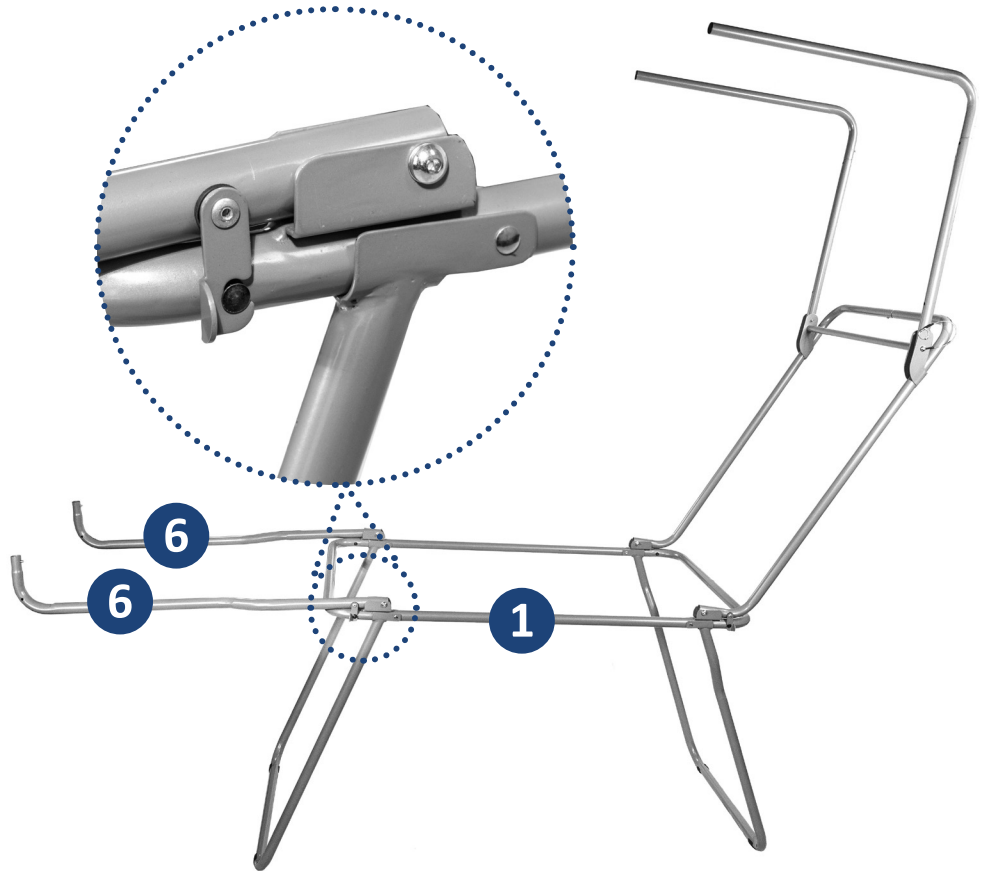

STEP 6

ID#	Name	Qty.
7	Lean Bar	x1
6	Front Arm Tube <i>Left & Right</i>	x2

Secure the (#7) Lean Bar to the (#6) Front Arm Tubes using the Spring Lock mechanism.

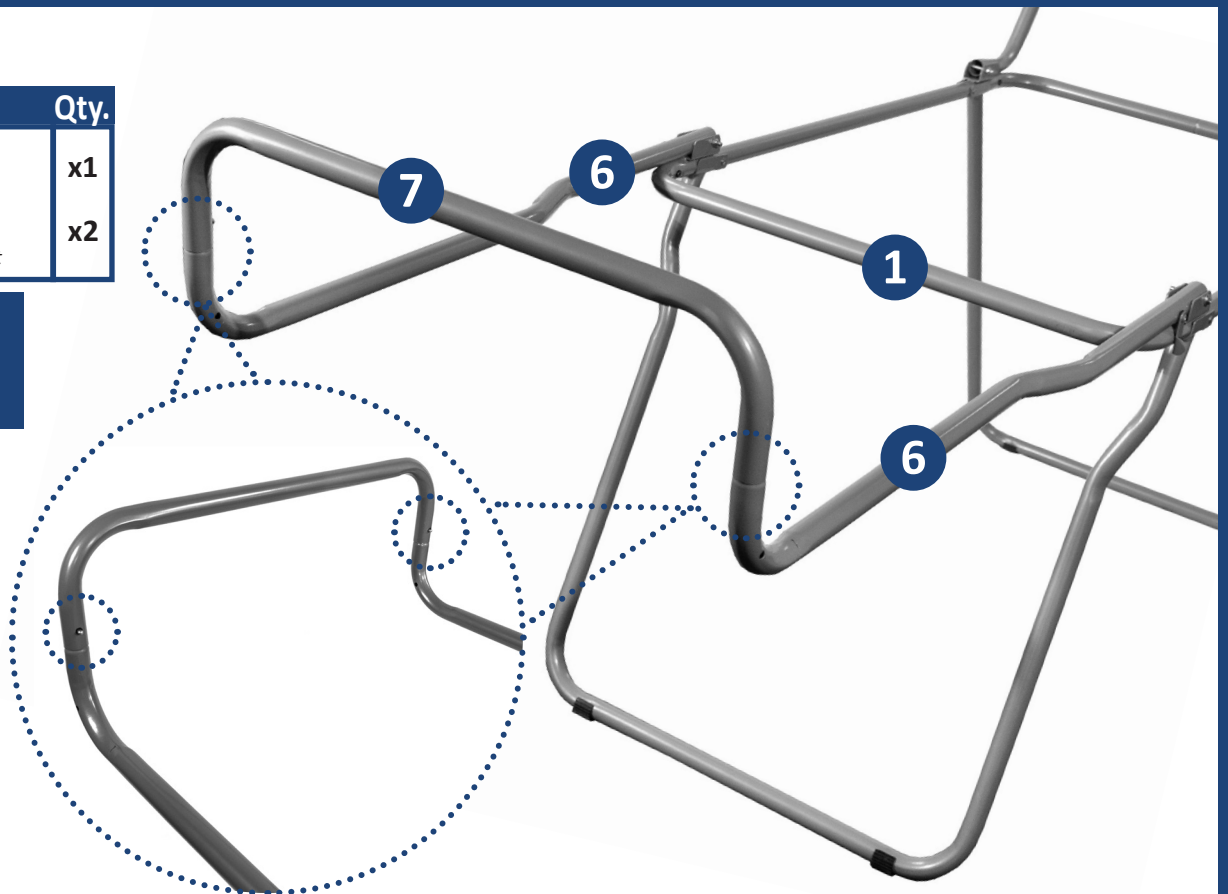

POP-A-SHOT

STEP 7

ID#	Name	Qty.
8	Rim	x1
9	Net	x1
10	Backboard	x1
16	Short Bolt	x4
17	Washer	x8
18	Nut	x4

Attach the (#8) Rim to the (#10) Backboard using a (#16) Short Bolt, one (#17) Washer on each side & (#18) Nut. After installing the (#8) Rim, attach the (#9) Net, making sure the longer strands are on top.

Note: If the net is not attached properly, scoring can be affected.

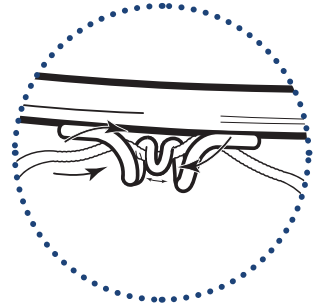
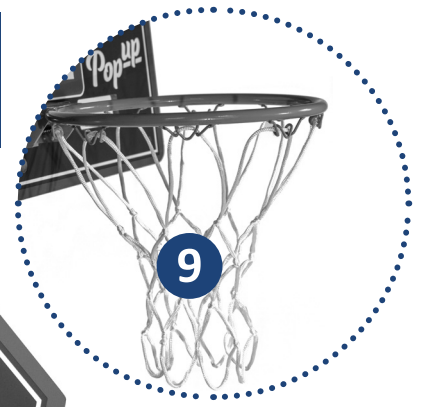
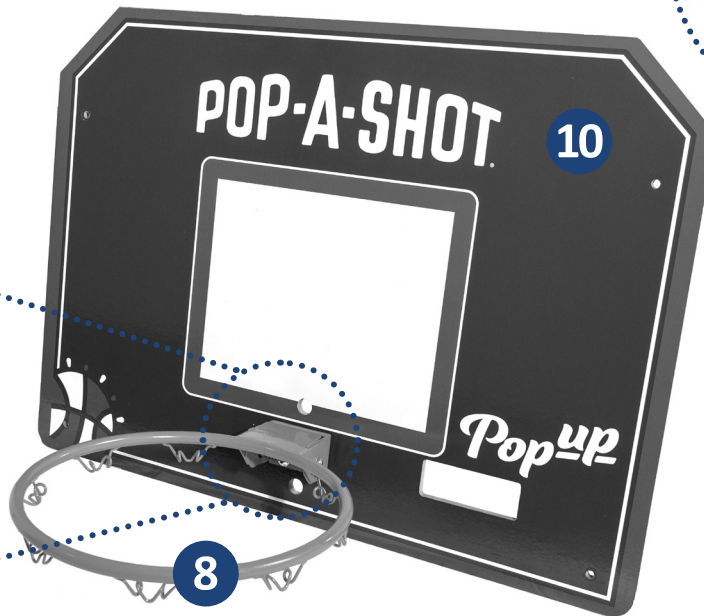
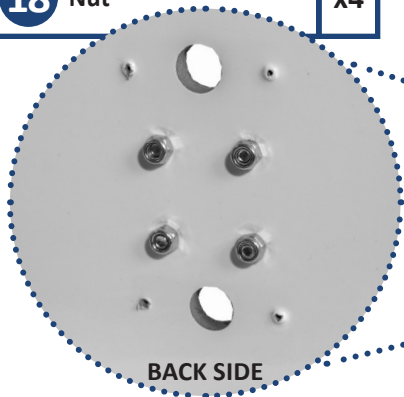

STEP 8

ID#	Name	Qty.
10	Backboard	x1
13	Scoreboard	x1
14	Sensor	x2
19	Small Screw	x4
25	Medium Screw	x4

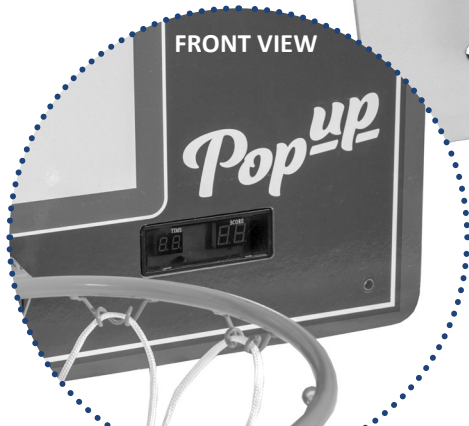
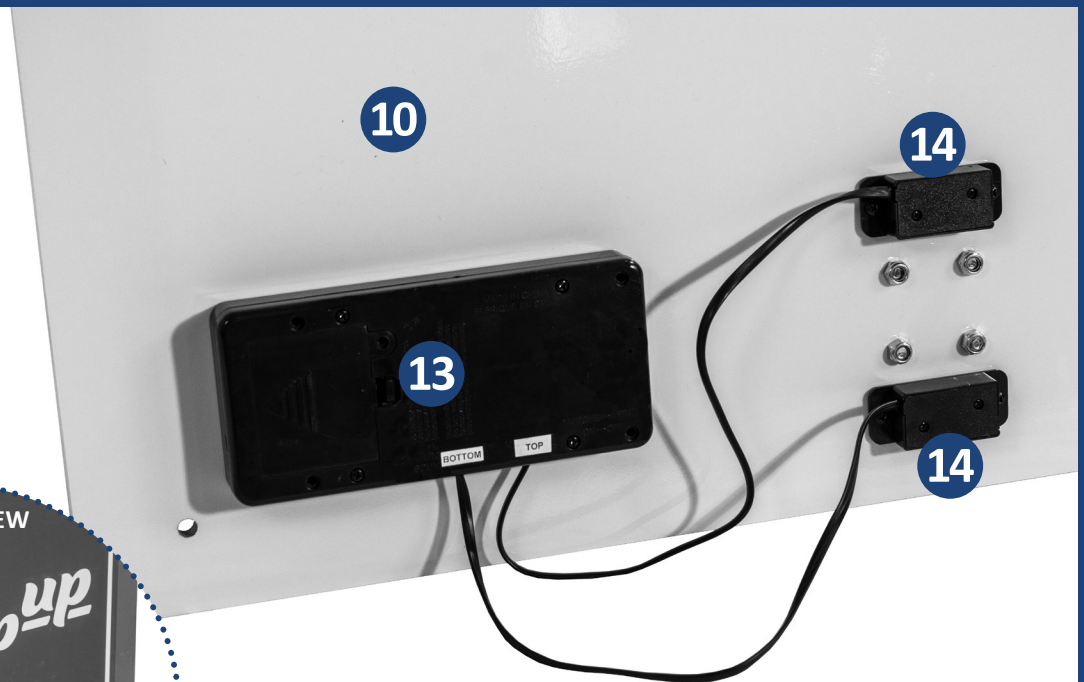

Place 3 AA batteries (not included) in the (#13) Scoreboard. Attach the (#13) Scoreboard to the rear of the (#10) Backboard using (#25) Medium Screws. Attach the (#14) Sensors to the (#10) Backboard using the (#19) Small Screws. Plug the (#14) Sensors into the proper top and bottom ports in the (#13) Scoreboard.

POP-A-SHOT

STEP 9

ID#	Name	Qty.
2	Backboard Brace	x2
10	Backboard	x1
28	Extra Long Bolt	x2
17	Washer	x4
18	Nut	x2

Attach the (#10) Backboard to the (#2) Backboard Braces using a (#28) Extra Long Bolt, one (#17) Washer on each side & (#18) Nut. Do not secure the bottom two bolts because they will be used to attach the (#11) Ball Return Ramp in the following step.

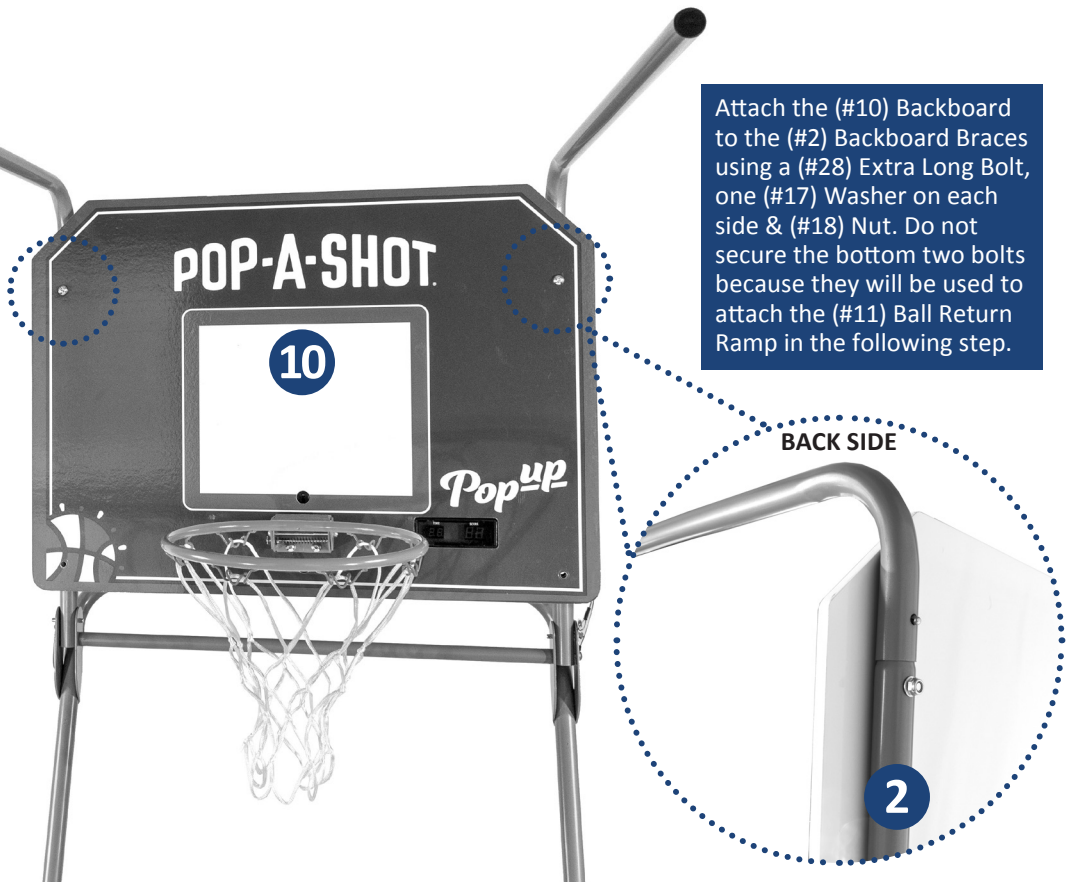

STEP 10

ID#	Name	Qty.
4	Top Tube <i>Left & Right</i>	x2
10	Backboard	x1
11	Ball Return Ramp	x1
28	Extra Long Bolt	x2
17	Washer	x4
18	Nut	x2

Slide the (#11) Ball Return Ramp sleeves over each (#4) Top Tube and attach the Plastic Tabs from the (#11) Ball Return Ramp to the rear of the bottom holes of the (#10) Backboard and (#2) Backboard Brace using the (#28) Extra Long Bolt, one (#17) Washer on each side & (#18) Nut. The (#11) Ball Return Ramp should be pulled behind the (#5) Rear Cross Tube before it is attached to the bottom of the (#10) Backboard.

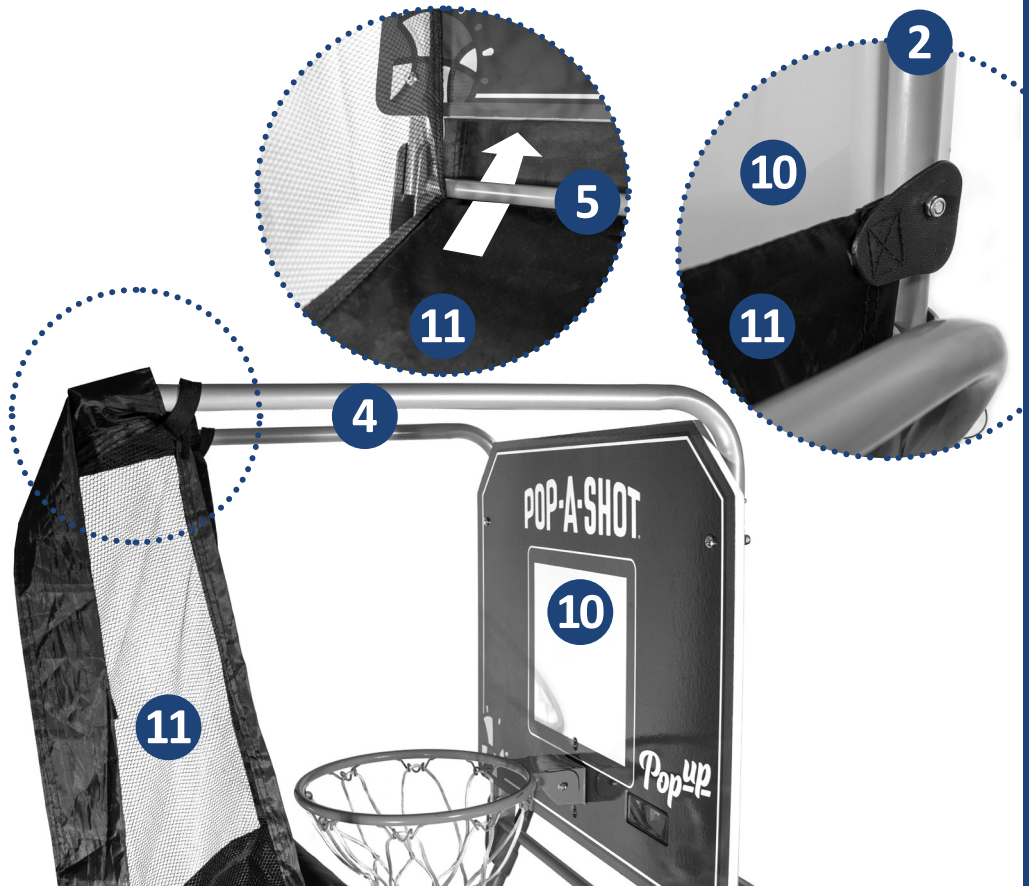

POP-A-SHOT

STEP 11

ID#	Name	Qty.
11	Ball Return Ramp	x1
12	Front Cross Tube	x1
27	Medium Bolt	x2
17	Washer	x4
18	Nut	x2

HOW TO PLAY :30

- Flip switch to "ON" on the bottom rear of the scoreboard.
- Baskets are 2 points until final 0:10 when they are 3 points.
- Bonus: 0:15 extra at 30 points
- 0:10 extra at 60 points.
- Shoot another basket to start an additional game.
- Game will hibernate if not played for 5 minutes and requires a reset.

READY TO PLAY!

Slide the (#12) Front Cross Tube through the pocket in the front of the (#11) Ball Return Ramp and secure the (#12) Front Cross Tube to the (#6) Front Arm Tube tubes using a (#27) Medium Bolt, one (#17) Washer on each side & (#18) Nut. Fasten the (#11) Ball Return Ramp hook and loop straps to the (#7) Lean Bar.

Note: If there is too much tension, fold the front of the game toward the middle to create slack.



HOW TO FOLD UP



STEP 1

Unlock all four gray locking clips and fold the front of the game toward the center.

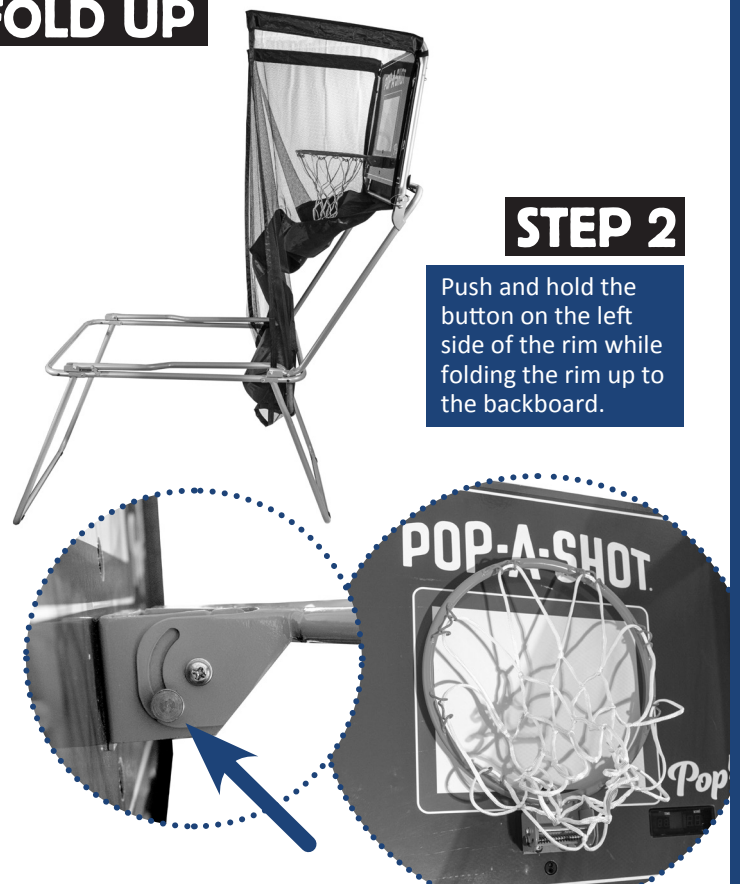

STEP 2

Push and hold the button on the left side of the rim while folding the rim up to the backboard.

POP-A-SHOT

STEP 3

HOW TO FOLD UP (Continued)

STEP 4



Push in the spring locks on the rear of the top tubes and turn each toward the inside of the game. These should lock into this new position using the spring locks.



Remove the locking pins from the backboard brace and then fold the backboard down toward the center of the game.

STEP 5

STEP 6



Fold the remaining backboard section toward the middle, then fold the legs under the game, Front Legs first.



Place the folded game into the included bag and you are good to go!

Use the folding instructions in reverse to set up your game and you are ready to play!