

< Silicon RF Power MOS FET (Discrete) >

RD35HUF2

RoHS Compliance, Silicon MOSFET Power Transistor, 175MHz, 530MHz, 35W

DESCRIPTION

RD35HUF2 is MOS FET type transistor specifically designed for VHF/UHF RF power amplifiers applications.

FEATURES

1. Supply with Tape and Reel. 500 Units per Reel.
2. Employing Mold Package
3. High Power and High Efficiency
 $P_{out}=43W_{typ}$, Drain Effi.=60% $_{typ}$
@ $V_{ds}=12.5V$ $I_{dq}=0.5A$ $P_{in}=3.0W$ $f=530MHz$
 $P_{out}=45W_{typ}$, Drain Effi.=72% $_{typ}$
@ $V_{ds}=12.5V$ $I_{dq}=1.0A$ $P_{in}=3.0W$ $f=175MHz$
4. Integrated gate protection diode

APPLICATION

For output stage of high power amplifiers in VHF/UHF band mobile radio sets.

RoHS COMPLIANT

RD35HUF2 is a RoHS compliant product. RoHS compliance is indicating by the letter "G" after the Lot Marking. This product includes the lead in high melting temperature type solders. However, it is applicable to the following exceptions of RoHS Directions.

1. Lead in high melting temperature type solders. (i.e. tin-lead solders alloys containing more than 85% lead.)

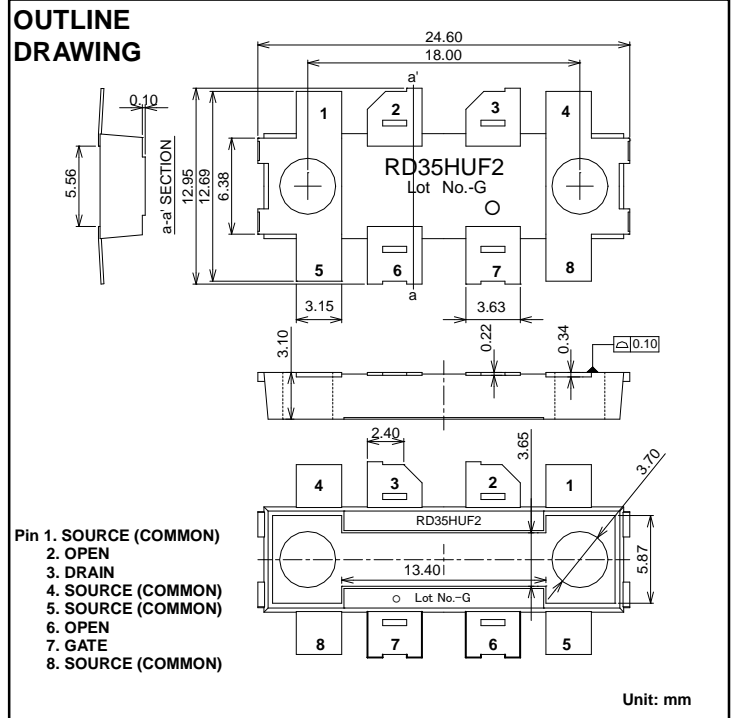

RD35HUF2

RoHS Compliance, Silicon MOSFET Power Transistor, 175MHz, 530MHz, 35W

ABSOLUTE MAXIMUM RATINGS ($T_c=25^\circ\text{C}$ UNLESS OTHERWISE NOTED)

SYMBOL	PARAMETER	CONDITIONS	RATINGS	UNIT
VDSS	Drain to Source Voltage	$V_{gs}=0V$	40	V
VGSS	Gate to Source Voltage	$V_{ds}=0V$	-5/+10	V
Pch	Channel Dissipation	$T_c=25^\circ\text{C}$	166	W
Pin	Input Power	$Z_g=Z_l=50\Omega$	6	W
ID	Drain Current	-	10	A
Tch	Channel Temperature	-	175	$^\circ\text{C}$
Tstg	Storage Temperature	-	-40 to +175	$^\circ\text{C}$
Rth j-c	Thermal Resistance	Junction to Case	0.9	$^\circ\text{C/W}$

Note: Above parameters are guaranteed independently.

ELECTRICAL CHARACTERISTICS ($T_c=25^\circ\text{C}$ UNLESS OTHERWISE NOTED)

SYMBOL	PARAMETER	CONDITIONS	LIMITS			UNIT
			MIN	TYP	MAX.	
I_{DSS}^*	Zero Gate Voltage Drain Current	$V_{DS}=37V, V_{GS}=0V$	-	-	150	μA
I_{GSS}^*	Gate to Source Leak Current	$V_{GS}=10V, V_{DS}=0V$	-	-	2.5	μA
V_{TH}^*	Gate Threshold Voltage	$V_{DS}=12V, I_{DS}=1\text{mA}$	1.6	2.0	2.4	V
Pout1	Output Power	$f=530\text{MHz}^*, V_{DS}=12.5V,$	-	43	-	W
η_{D1}	Drain Efficiency	$P_{in}=3.0W, I_{dq}=500\text{mA}$	-	60	-	%
Pout2	Output Power	$f=175\text{MHz}^{**}, V_{DS}=12.5V,$	-	45	-	W
η_{D2}	Drain Efficiency	$P_{in}=3.0W, I_{dq}=500\text{mA}$	-	72	-	%
VSWRT	Load VSWR Tolerance	All phase, $V_{DS}=16.3V$ increased after Pout adjusted to 40W ($Z_g/Z_l=50\Omega$) by Pin (under $f=135\text{MHz}^{**}, V_{DS}=12.5V$ and $I_{dq}=500\text{mA}$)	20:1	-	-	VSWR

Note: Above parameters, ratings, limits and conditions are subject to change.

* In Mitsubishi UHF Evaluation Board

** In Mitsubishi VHF Evaluation Board

RD35HUF2

RoHS Compliance, Silicon MOSFET Power Transistor, 175MHz, 530MHz, 35W

TYPICAL CHARACTERISTICS

(These are only typical curves and devices are not necessarily guaranteed at these curves.)

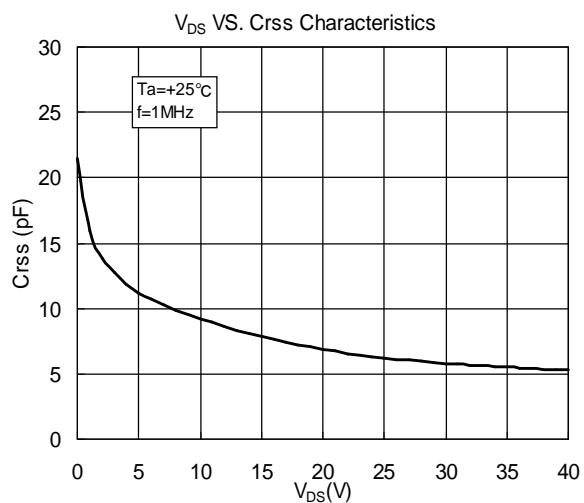
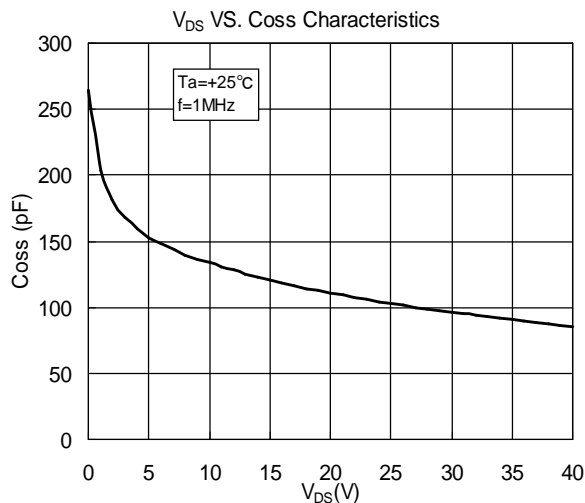
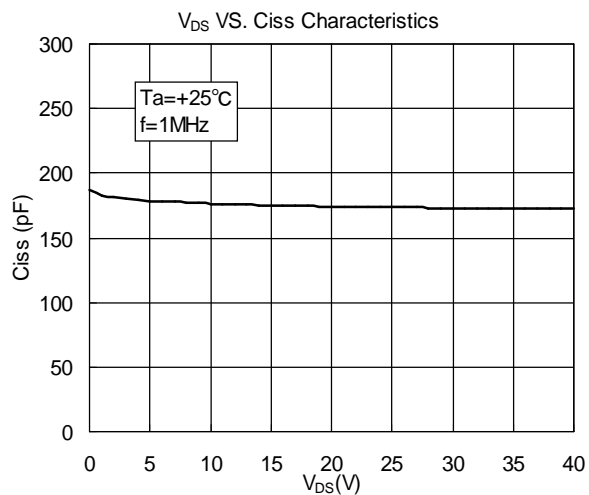
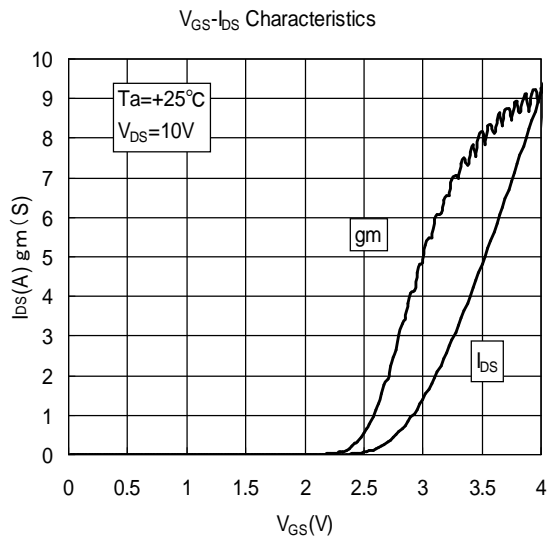
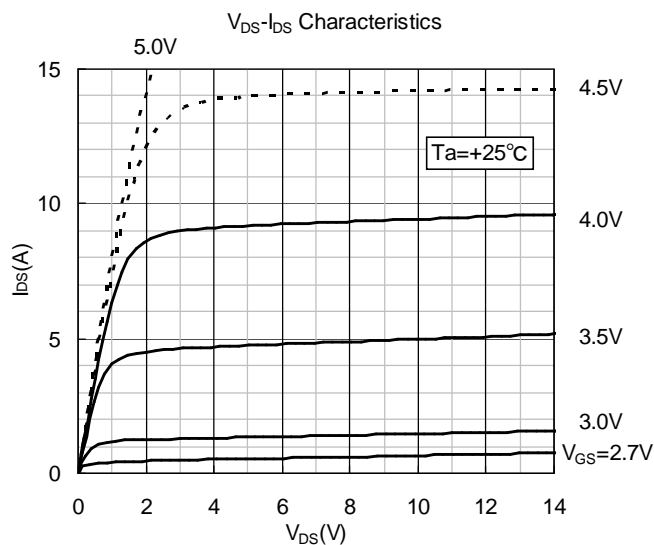

RD35HUF2

RoHS Compliance, Silicon MOSFET Power Transistor, 175MHz, 530MHz, 35W

VHF-band TYPICAL CHARACTERISTICS

(These are only typical curves and devices are not necessarily guaranteed at these curves.)

Frequency Characteristics @f=135 to 175MHz

Ta=+25deg.C

Vds=12.5V, Idq=0.5A, Pin=3W

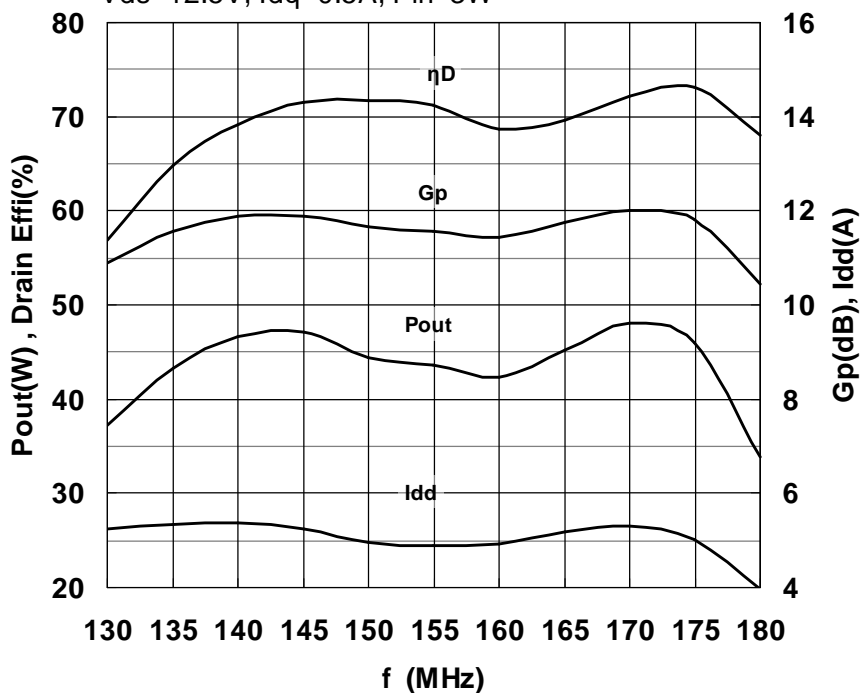

RD35HUF2

RoHS Compliance, Silicon MOSFET Power Transistor, 175MHz, 530MHz, 35W

VHF-band TYPICAL CHARACTERISTICS

(These are only typical curves and devices are not necessarily guaranteed at these curves.)

Output Power versus Input Power

Ta=+25deg.C, Vds=12.5V, Idq=0.5A

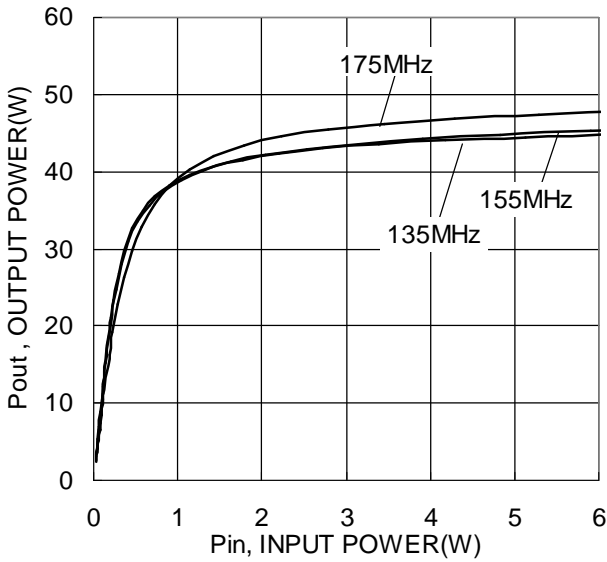

Input Return Loss versus Output Power

Ta=+25deg.C, Vds=12.5V, Idq=0.5A

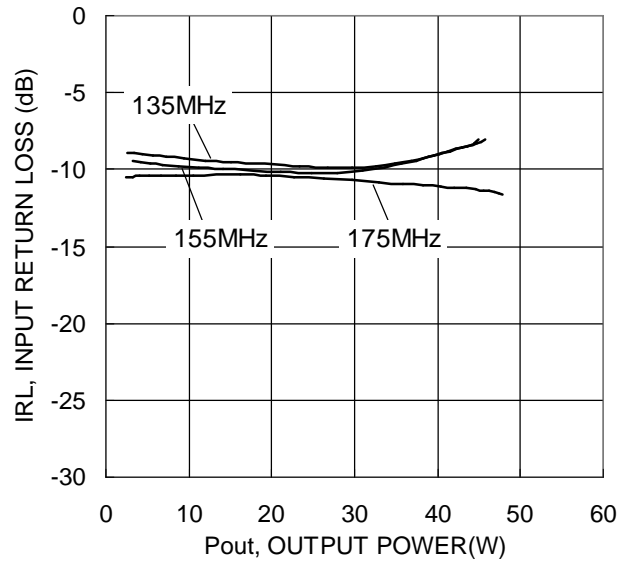

Gain versus Output Power

Ta=+25deg.C, Vds=12.5V, Idq=0.5A

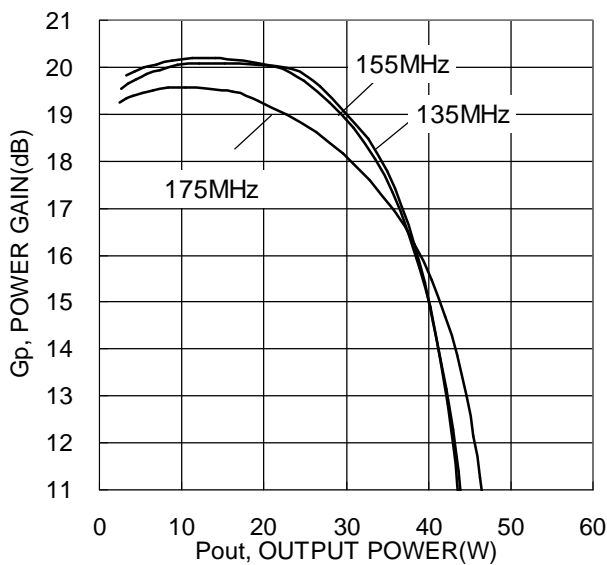

Drain Efficiency versus Output Power

Ta=+25deg.C, Vds=12.5V, Idq=0.5A

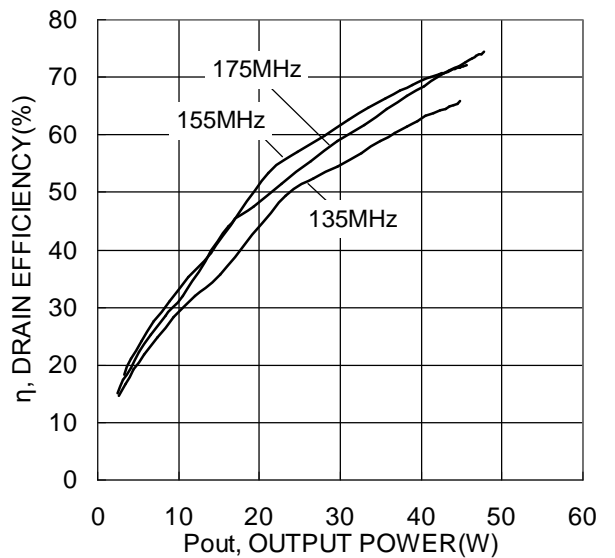

RD35HUF2

RoHS Compliance, Silicon MOSFET Power Transistor, 175MHz, 530MHz, 35W

VHF-band TYPICAL CHARACTERISTICS

(These are only typical curves and devices are not necessarily guaranteed at these curves.)

Output Power versus Biasing Current

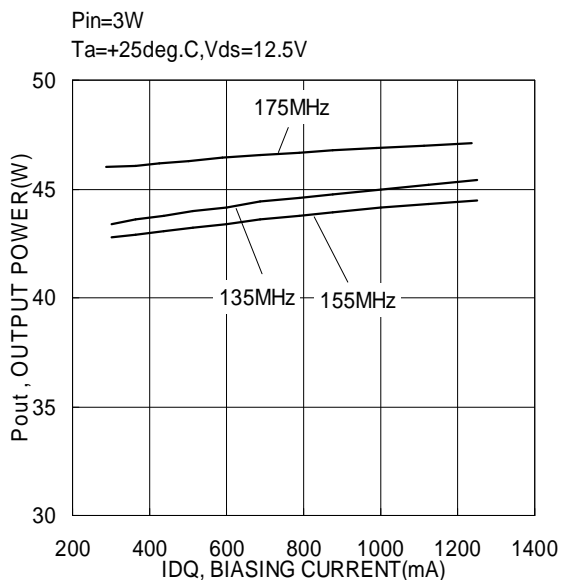

Drain Efficiency versus Biasing Current

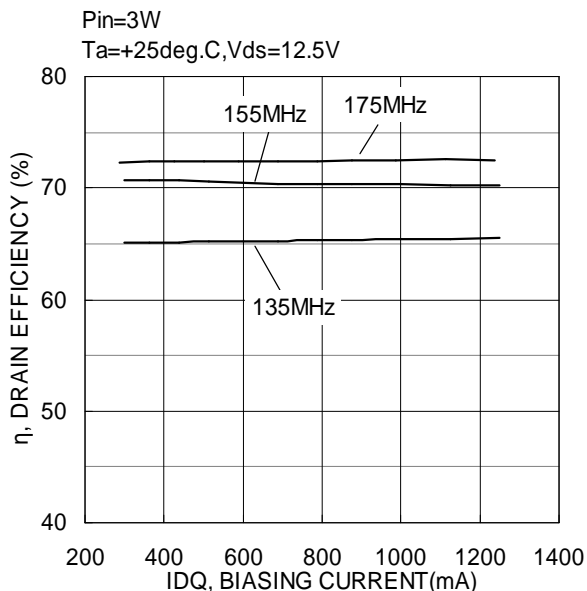

Output Power versus Supply Voltage

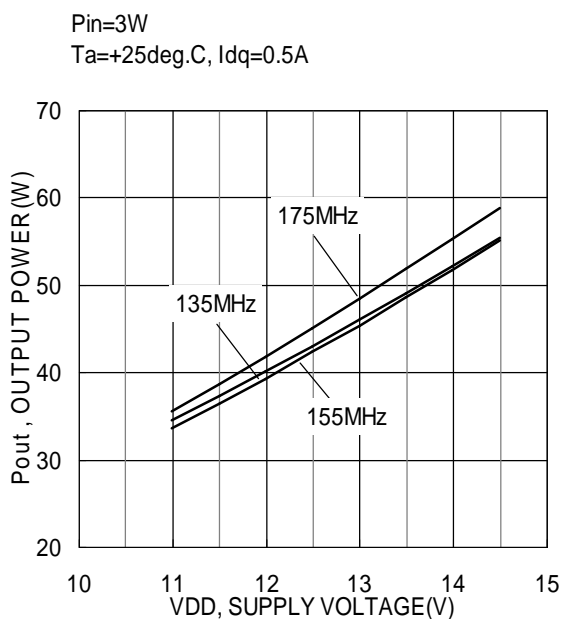

Drain Efficiency versus Supply Voltage

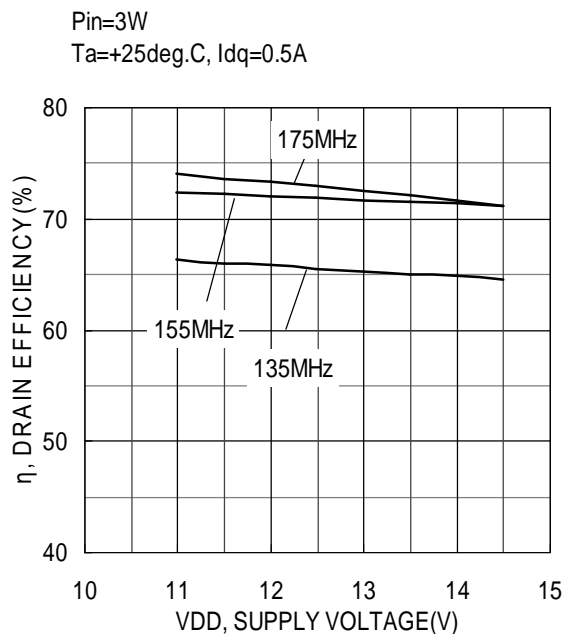

RD35HUF2

RoHS Compliance, Silicon MOSFET Power Transistor, 175MHz, 530MHz, 35W

UHF-band, 380 - 430MHz, TYPICAL CHARACTERISTICS

(These are only typical curves and devices are not necessarily guaranteed at these curves.)

Output Power versus Input Power

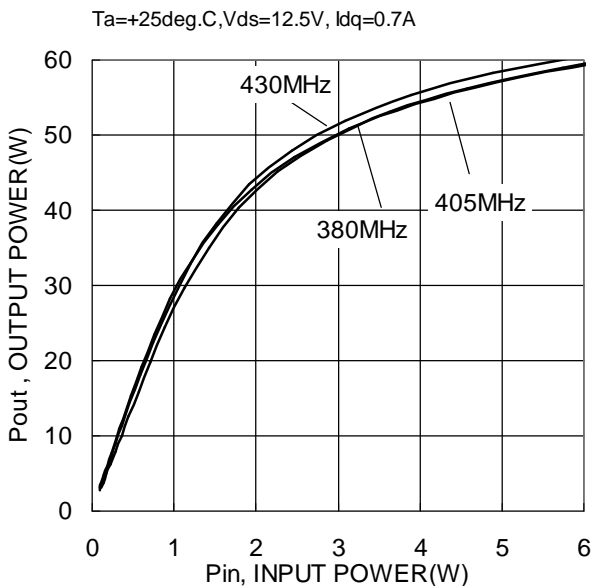

Input Return Loss versus Output Power

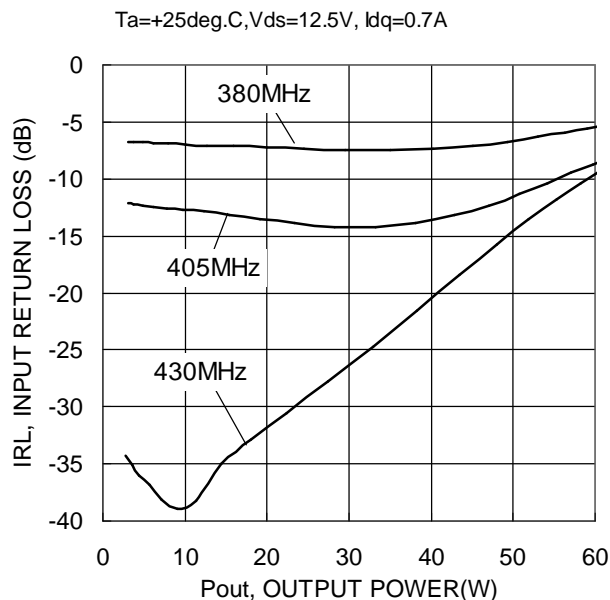

Gain versus Output Power

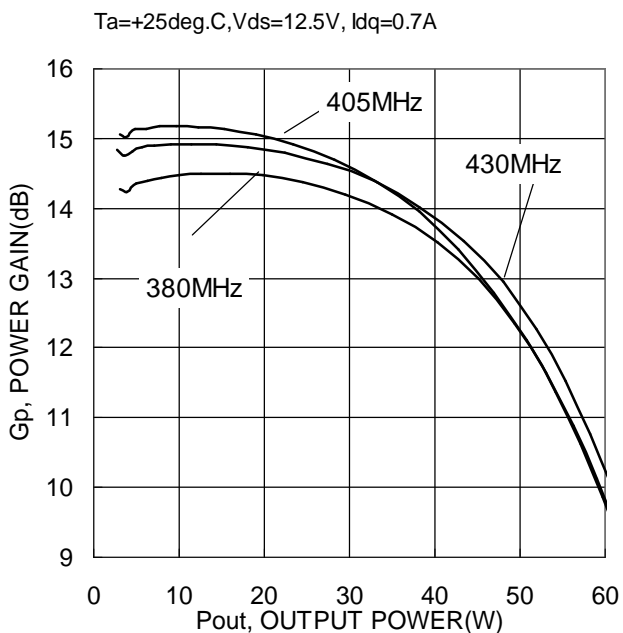

Drain Efficiency versus Output Power

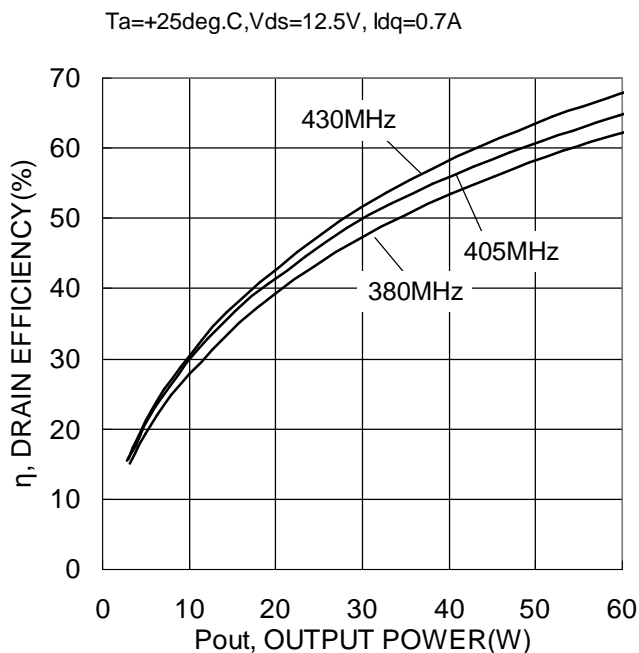

RD35HUF2

RoHS Compliance, Silicon MOSFET Power Transistor, 175MHz, 530MHz, 35W

UHF-band, 380 - 430MHz, TYPICAL CHARACTERISTICS

(These are only typical curves and devices are not necessarily guaranteed at these curves.)

Output Power versus Input Power, Digital Modulation

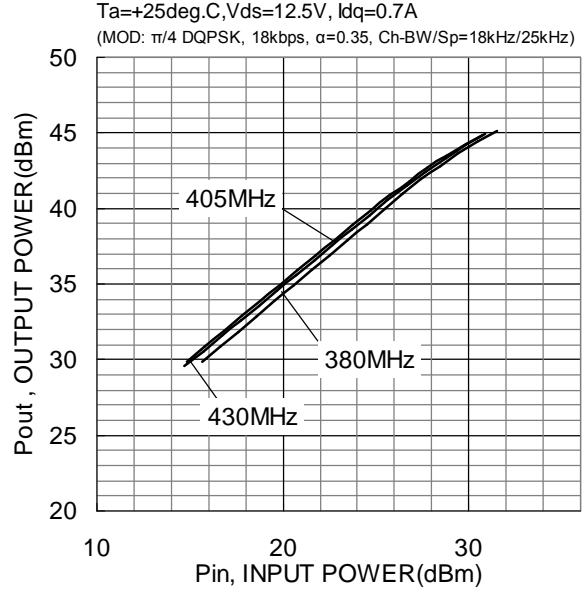
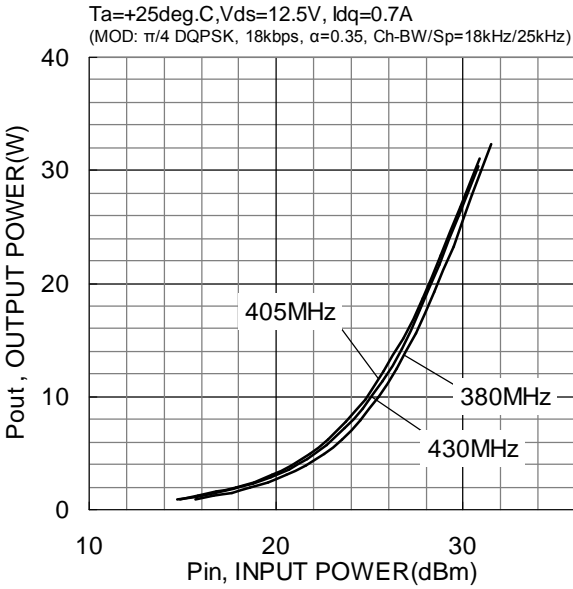

Gain and Adjacent Channel Power Ratio versus Output Power, Digital Modulation

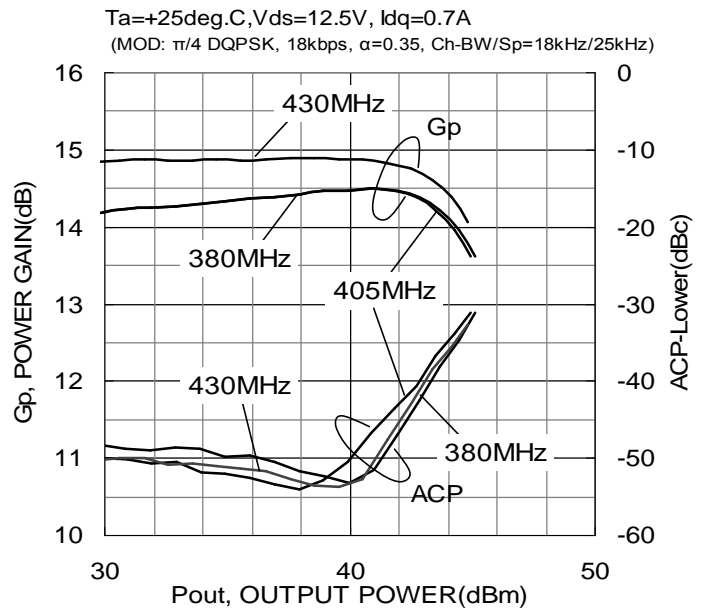
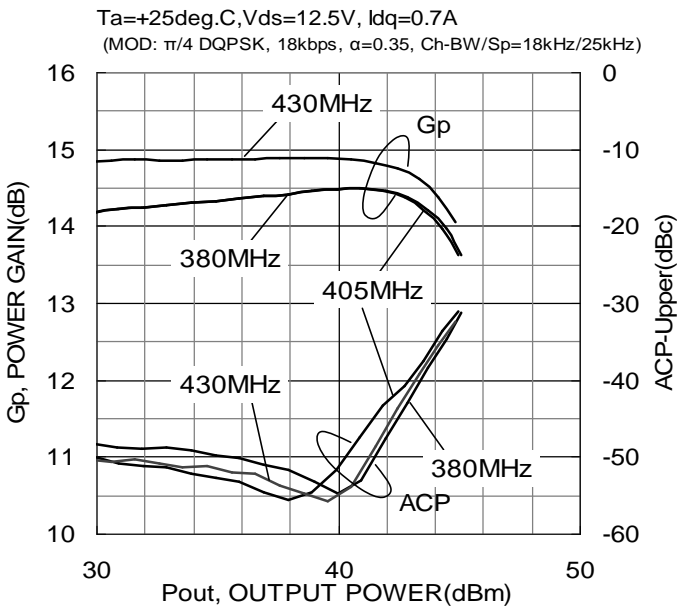

RD35HUF2

RoHS Compliance, Silicon MOSFET Power Transistor, 175MHz, 530MHz, 35W

UHF-band, 450 - 530MHz, TYPICAL CHARACTERISTICS

(These are only typical curves and devices are not necessarily guaranteed at these curves.)

Frequency Characteristics @f=450 to 530MHz

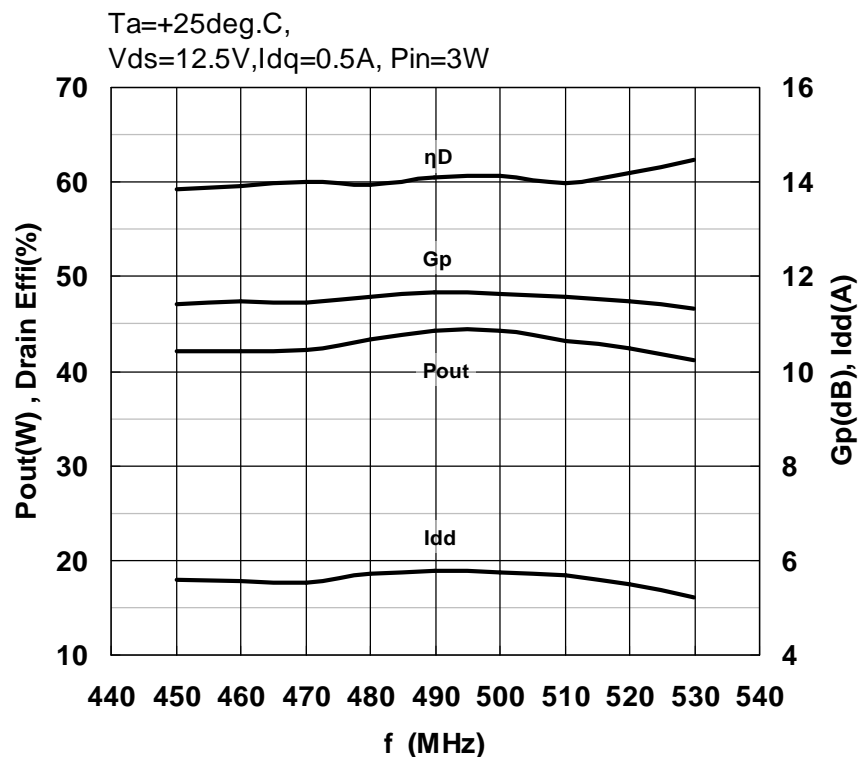

RD35HUF2

RoHS Compliance, Silicon MOSFET Power Transistor, 175MHz, 530MHz, 35W

UHF-band, 450 - 530MHz, TYPICAL CHARACTERISTICS

(These are only typical curves and devices are not necessarily guaranteed at these curves.)

Output Power versus Input Power

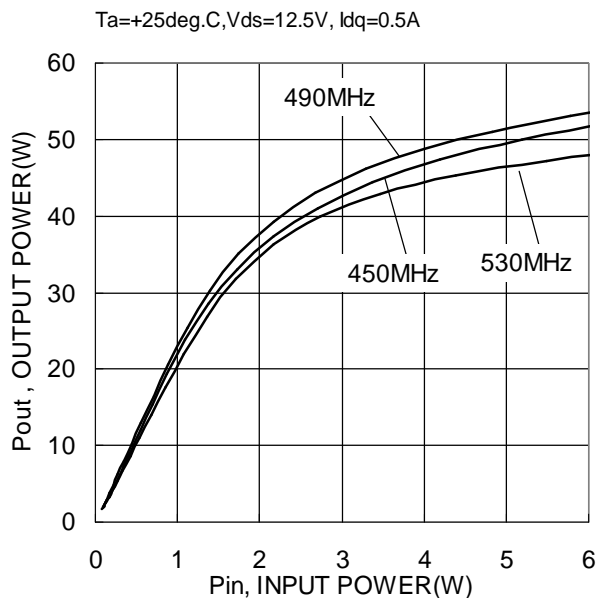

Input Return Loss versus Output Power

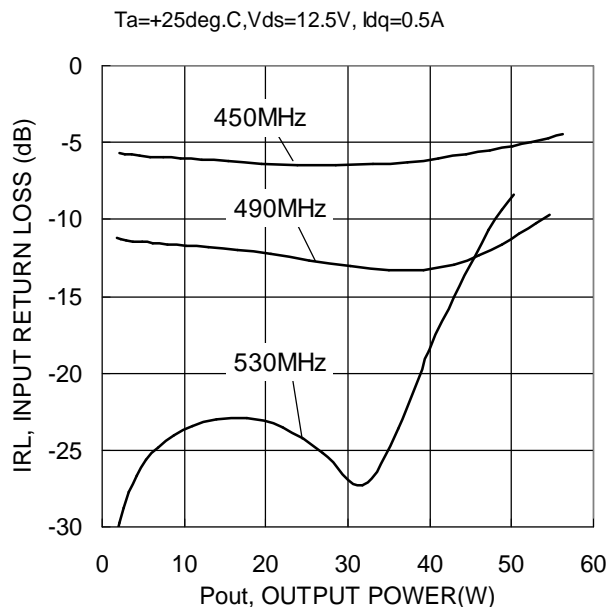

Gain versus Output Power

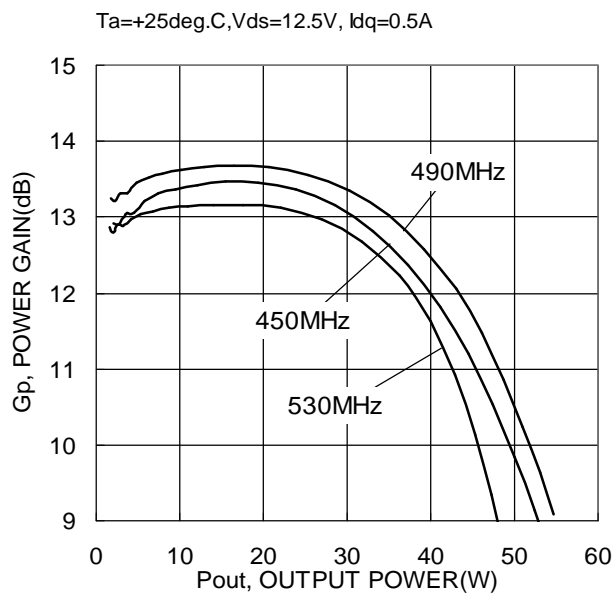

Drain Efficiency versus Output Power

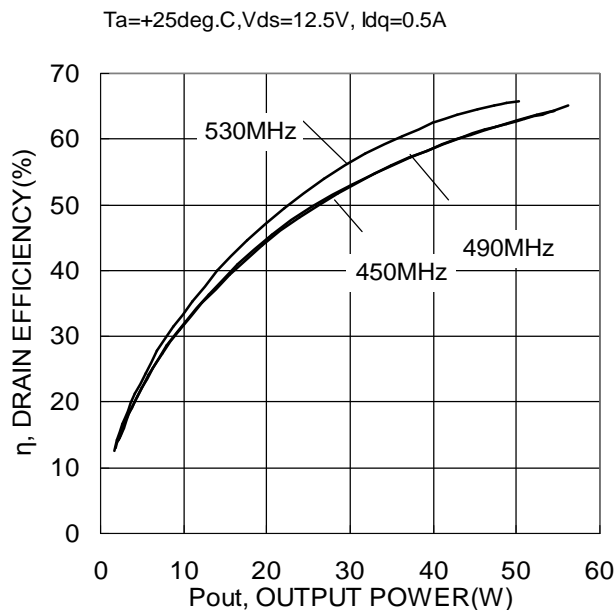

RD35HUF2

RoHS Compliance, Silicon MOSFET Power Transistor, 175MHz, 530MHz, 35W

UHF-band, 450 - 530MHz, TYPICAL CHARACTERISTICS

(These are only typical curves and devices are not necessarily guaranteed at these curves.)

Output Power versus Biasing Current

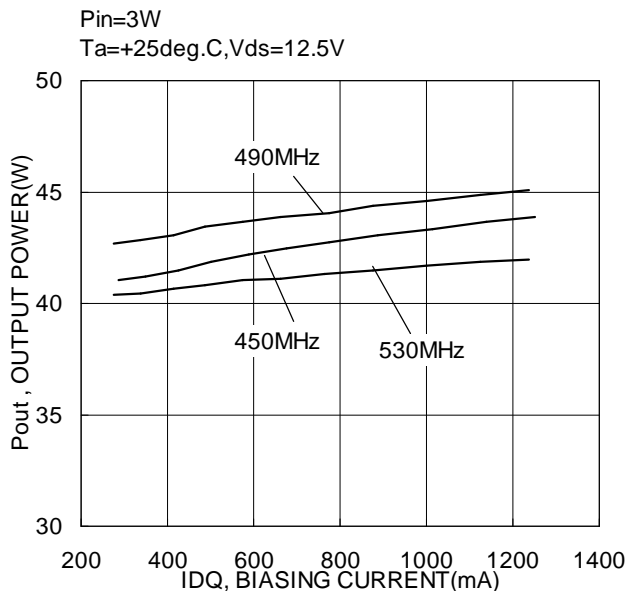

Drain Efficiency versus Biasing Current

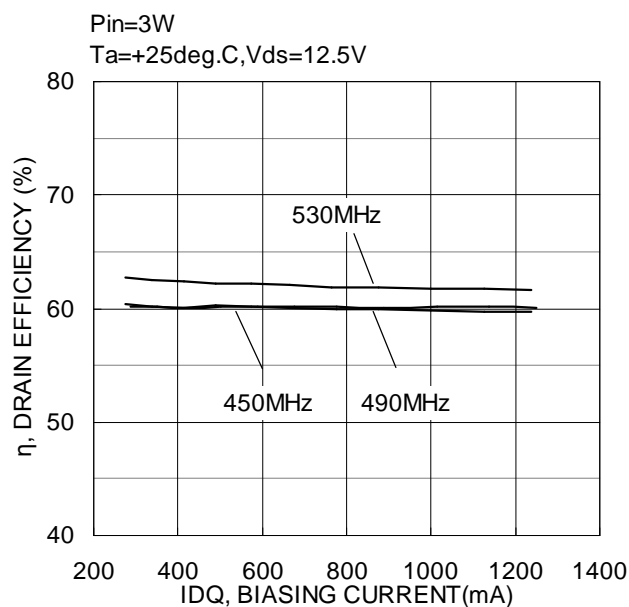

Output Power versus Supply Voltage

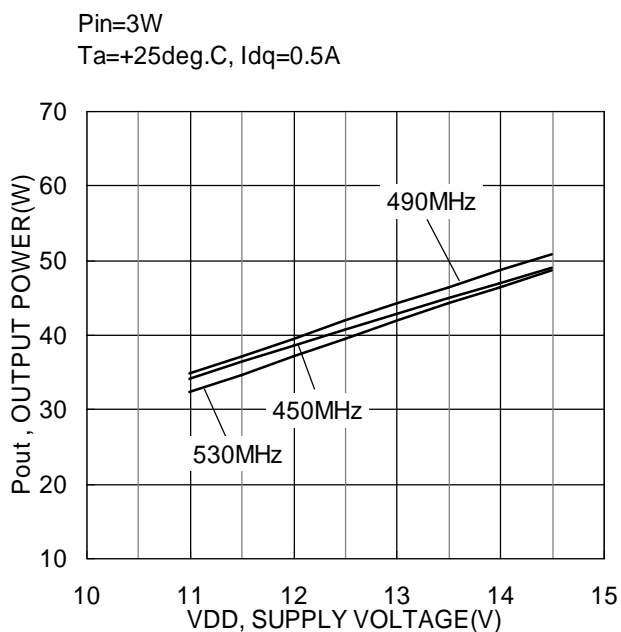

Drain Efficiency versus Supply Voltage

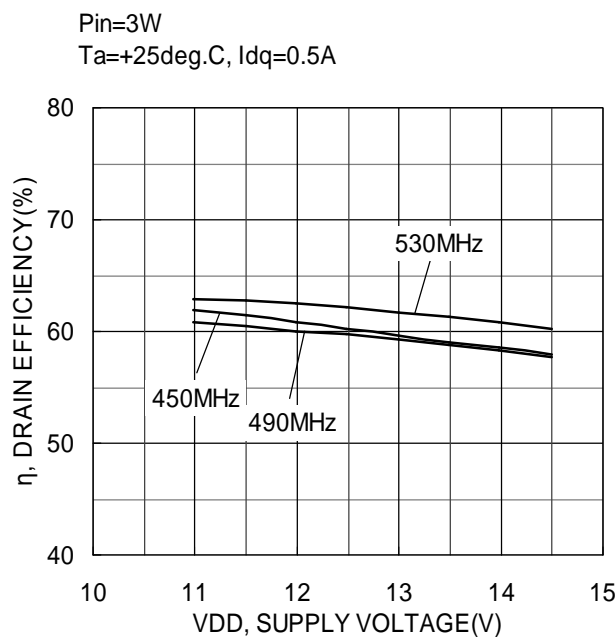

RD35HUF2

RoHS Compliance, Silicon MOSFET Power Transistor, 175MHz, 530MHz, 35W

EQUIVALENT CIRCUITRY for VHF EVALUATION BOARD (f=135 - 175MHz)

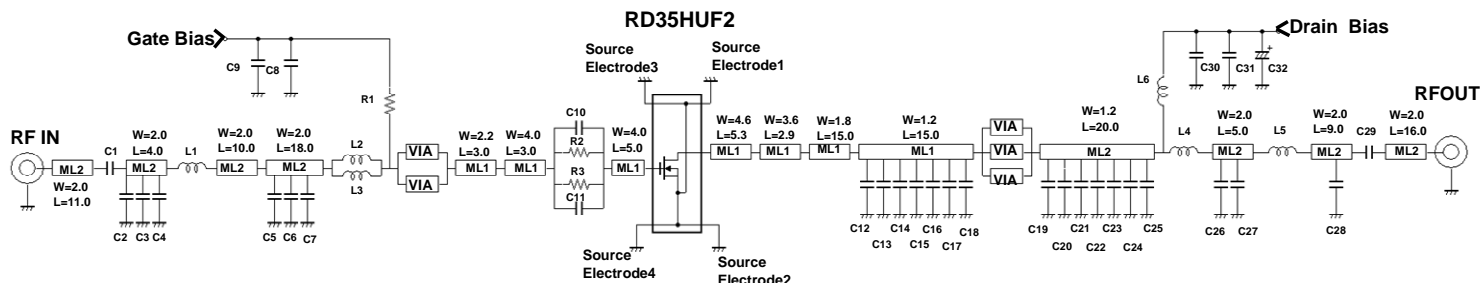

Board material: Glass Epoxy Substrate--
er=4.8, TanD=0.018 @1GHz

Micro Strip Line Substrate Thickness: ML1, T=0.2
ML2, T=1.1

VIA Hole Dimensions, Diameter=0.8 Length=1.6

UNIT: W/L/T, mm

C1	470 pF	3.2*1.6	Chip Ceramic Capacitors
C2, C3	22 pF	1.6*0.8	High Q Chip Ceramic Capacitors
C4	12 pF	1.6*0.8	High Q Chip Ceramic Capacitors
C5, C6, C7	68 pF	1.6*0.8	High Q Chip Ceramic Capacitors
C8, C9	1000 pF	2.0*1.2	Chip Ceramic Capacitors
C10, C11	100 pF	1.6*0.8	High Q Chip Ceramic Capacitors
L1	17 nH	-	4Turn Rolling Coil
L2, L3	10 nH	1.6*0.8	chip Inductors
R1	2200 ohm	1.6*0.8	chip Resistors
R2, R3	16 ohm	2.0*1.2	chip Resistors

C12, C13, C14, C15, C16	15 pF	2.0*1.2	High Q Chip Ceramic Capacitors
C17, C18, C19, C20	47 pF	2.0*1.2	High Q Chip Ceramic Capacitors
C21, C22, C23, C24, C25	22 pF	2.0*1.2	High Q Chip Ceramic Capacitors
C26	18 pF	2.0*1.2	High Q Chip Ceramic Capacitors
C27	15 pF	2.0*1.2	High Q Chip Ceramic Capacitors
C28	24 pF	2.0*1.2	High Q Chip Ceramic Capacitors
C29	470 pF	3.2*1.6	Chip Ceramic Capacitors
C30, C31	1000 pF	2.0*1.2	Chip Ceramic Capacitors
C32	220 uF	-	35V, Electrolytic Capacitor
L4	8 nH	-	2Turn Rolling Coil
L5	12 nH	-	3Turn Rolling Coil
L6	25 nH	-	5Turn Rolling Coil

For more information regarding this evaluation board, refer to APPLICATION NOTE "AN-VHF-048"

RD35HUF2

RoHS Compliance, Silicon MOSFET Power Transistor, 175MHz, 530MHz, 35W

EQUIVALENT CIRCUITRY for UHF EVALUATION BOARD (f=380 - 430MHz)

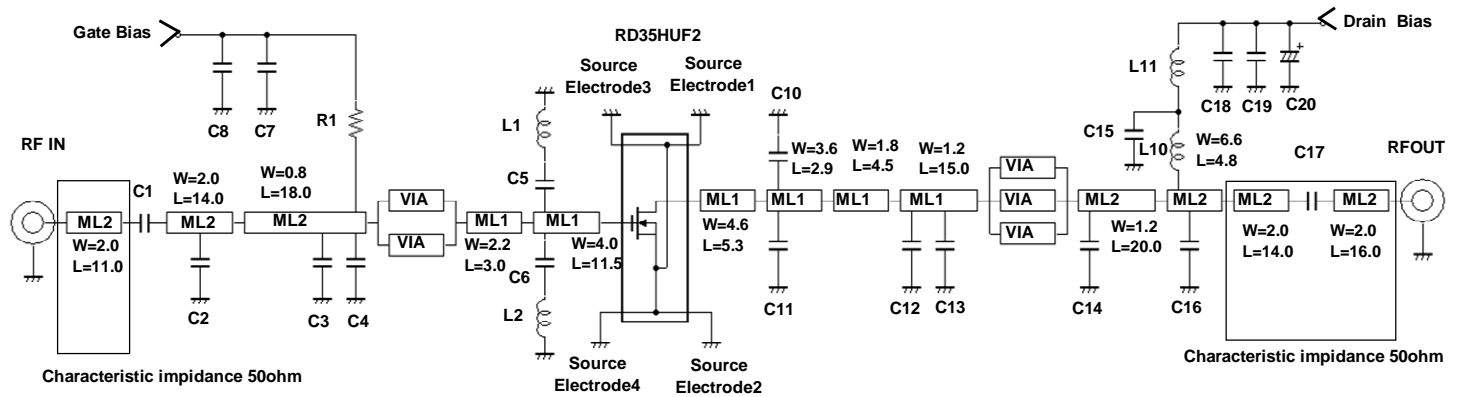

Board material: Glass Epoxy Substrate--
er=4.8, TanD=0.018 @1GHz

Micro Strip Line Substrate Thickness: ML1, T=0.2
ML2, T=1.1

VIA Hole Dimensions, Diameter=0.8 Length=1.6

UNIT: W/L/T, mm

C1	330 pF	3.2*1.6	Chip Ceramic Capacitors
C2	6 pF	1.6*0.8	High Q Chip Ceramic
C3	27 pF	1.6*0.8	High Q Chip Ceramic
C4	9 pF	1.6*0.8	High Q Chip Ceramic
C5, C6	18 pF	1.6*0.8	High Q Chip Ceramic
C7, C8	1000 pF	2.0*1.2	Chip Ceramic Capacitors
R1	2.2 kohm	1.6*0.8	
L1, L2	2.2 nH	1.6*0.8	Chip Inductors
C10	33 pF	2.0*1.2	High Q Chip Ceramic
C11	33 pF	2.0*1.2	High Q Chip Ceramic
C12	18 pF	2.0*1.2	High Q Chip Ceramic
C13	18 pF	2.0*1.2	High Q Chip Ceramic
C14	5 pF	2.0*1.2	High Q Chip Ceramic
C15	1.2 pF	2.0*1.2	High Q Chip Ceramic
C16	9 pF	2.0*1.2	High Q Chip Ceramic
C17	100 pF	3.2*2.5	High Q Chip Ceramic
C18, C19	1000 pF	2.0*1.2	Chip Ceramic Capacitors
C20	220 uF	-	35V, Electrolytic Capacitor
L10	8 nH	-	2Turn Rolling Coil
L11	17 nH	-	4Turn Rolling Coil

For more information regarding this evaluation board, refer to APPLICATION NOTE "AN-UHF-127"

RD35HUF2

RoHS Compliance, Silicon MOSFET Power Transistor, 175MHz, 530MHz, 35W

EQUIVALENT CIRCUITRY for UHF EVALUATION BOARD (f=450 - 530MHz)

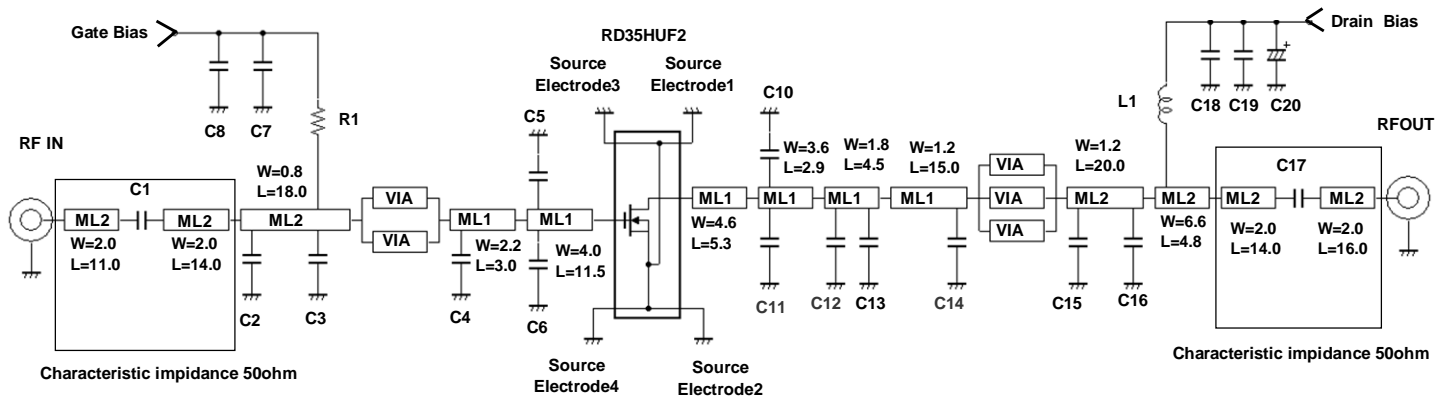

Board material: Glass Epoxy Substrate--
er=4.8, TanD=0.018 @1GHz

Micro Strip Line Substrate Thickness: ML1, T=0.2
ML2, T=1.1

VIA Hole Dimensions, Diameter=0.8 Length=1.6

UNIT: W/L/T, mm

C1	330 pF	3.2*1.6	Chip Ceramic Capacitors
C2	6.2 pF	1.6*0.8	High Q Chip Ceramic
C3	18 pF	1.6*0.8	High Q Chip Ceramic
C4	9 pF	1.6*0.8	High Q Chip Ceramic
C5, C6	18 pF	1.6*0.8	High Q Chip Ceramic
C7, C8	1000 pF	2.0*1.2	Chip Ceramic Capacitors
R1	2.2 kohm	1.6*0.8	
C10	33 pF	2.0*1.2	High Q Chip Ceramic
C11	33 pF	2.0*1.2	High Q Chip Ceramic
C12	2.4 pF	2.0*1.2	High Q Chip Ceramic
C13	12 pF	2.0*1.2	High Q Chip Ceramic
C14	3.3 pF	2.0*1.2	High Q Chip Ceramic
C15	5.1 pF	2.0*1.2	High Q Chip Ceramic
C16	9.1 pF	2.0*1.2	High Q Chip Ceramic
C17	100 pF	3.2*2.5	High Q Chip Ceramic
C18, C19	1000 pF	2.0*1.2	Chip Ceramic Capacitors
C20	220 uF	-	35V, Electrolytic Capacitor
L1	29 nH	-	6Turn Rolling Coil

For more information regarding this evaluation board, refer to APPLICATION NOTE "AN-UHF-112"

RD35HUF2

RoHS Compliance, Silicon MOSFET Power Transistor, 175MHz, 530MHz, 35W

Input / Output Impedance VS. Frequency Characteristics

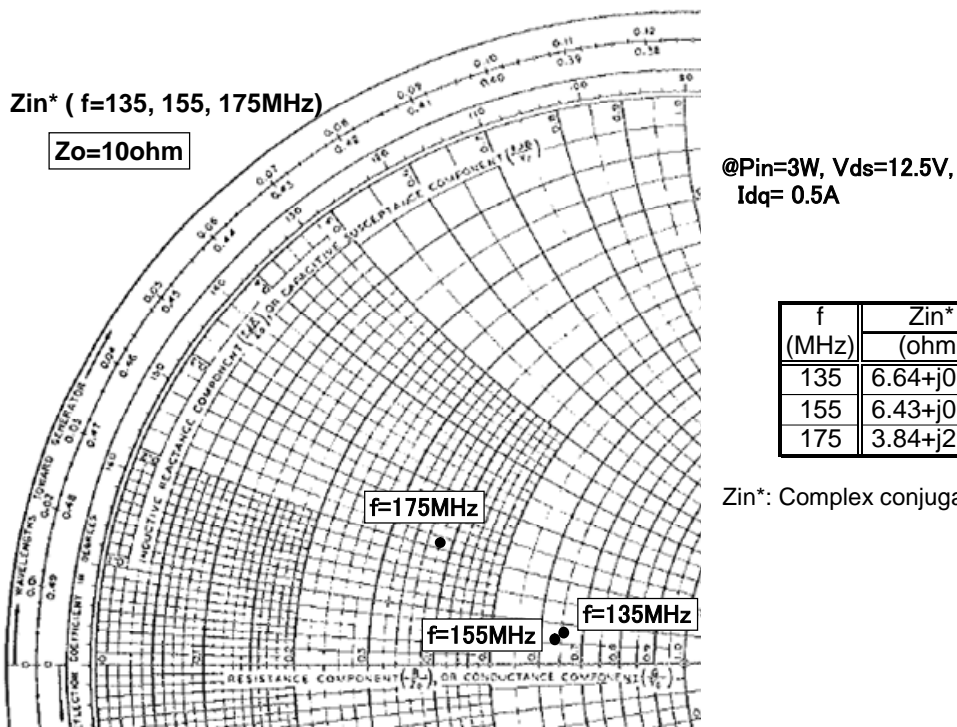
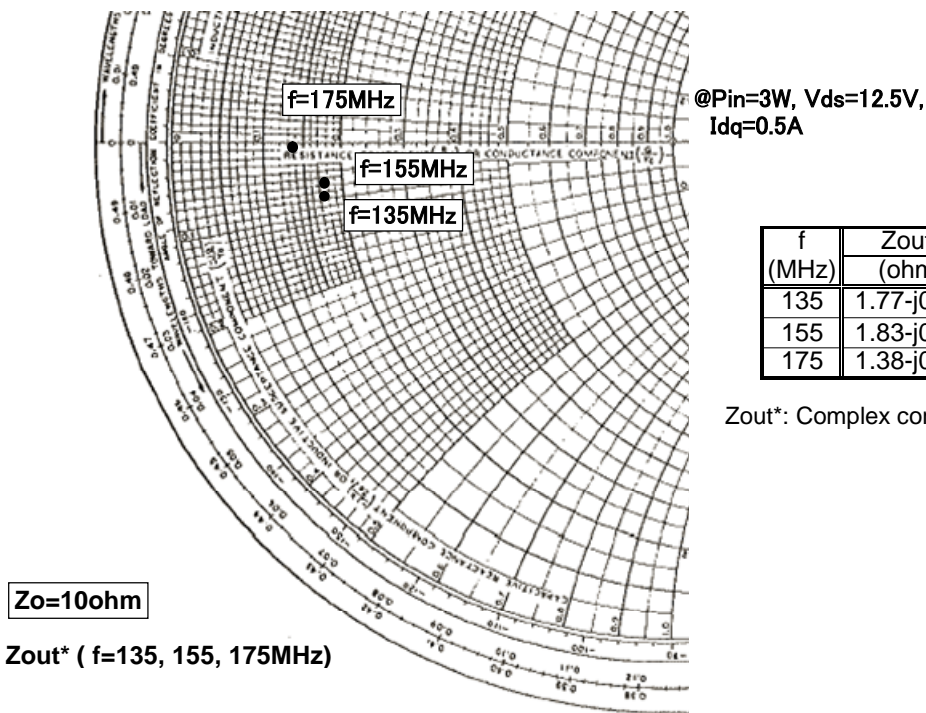

RD35HUF2

RoHS Compliance, Silicon MOSFET Power Transistor, 175MHz, 530MHz, 35W

Input / Output Impedance VS. Frequency Characteristics

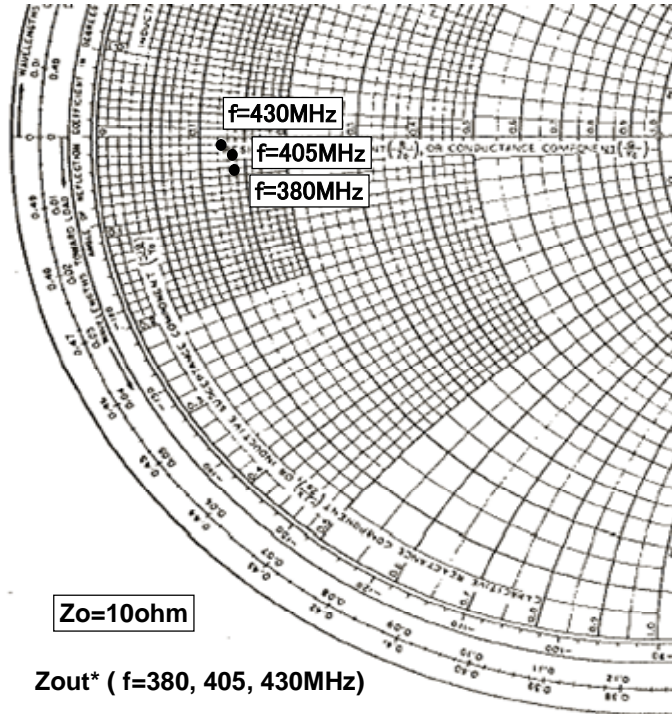

@Pin=3W, Vds=12.5V,
Idq=0.5A

f (MHz)	Zout* (ohm)
380	1.44-j0.41
405	1.43-j0.30
430	1.30-j0.19

Zout*: Complex conjugate of output impedance

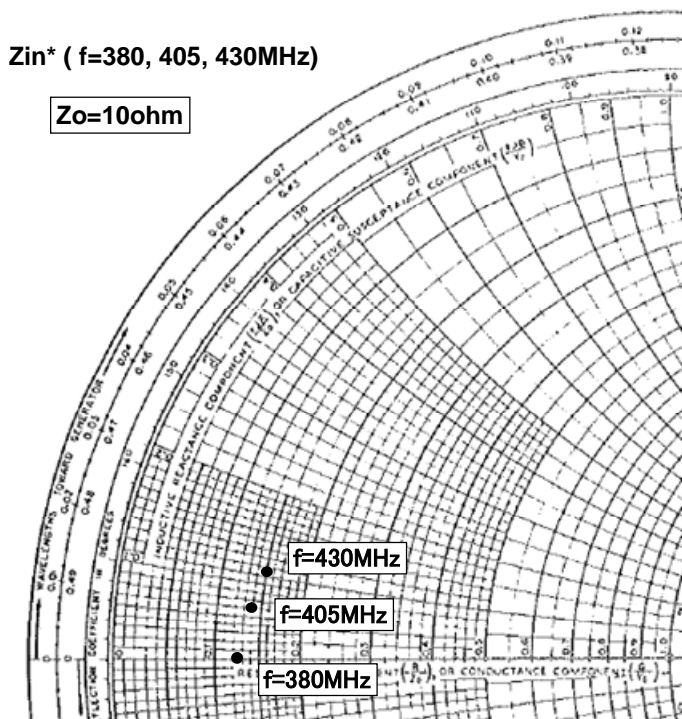

@Pin=3W, Vds=12.5V,
Idq= 0.5A

f (MHz)	Zin* (ohm)
380	1.34+j0.00
405	1.43+j0.58
430	1.52+j1.11

Zin*: Complex conjugate of input impedance

RD35HUF2

RoHS Compliance, Silicon MOSFET Power Transistor, 175MHz, 530MHz, 35W

Input / Output Impedance VS. Frequency Characteristics

Zout* (f=450, 490, 530MHz)

Zo=10ohm

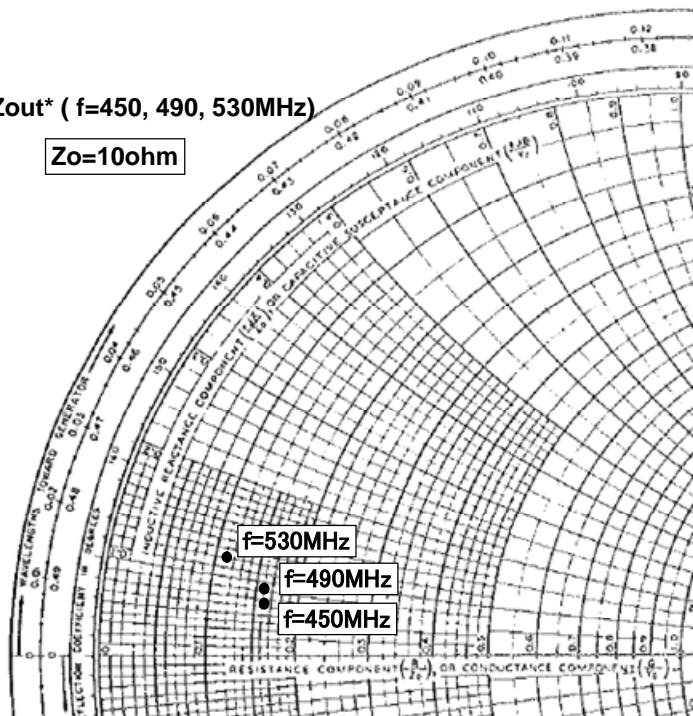

@Pin=3W, Vds=12.5V,
Idq=0.5A

f (MHz)	Zout* (ohm)
450	1.59+j0.69
490	1.57+j0.91
530	1.14+j1.24

Zout*: Complex conjugate of output impedance

Zin* (f=450, 490, 530MHz)

Zo=10ohm

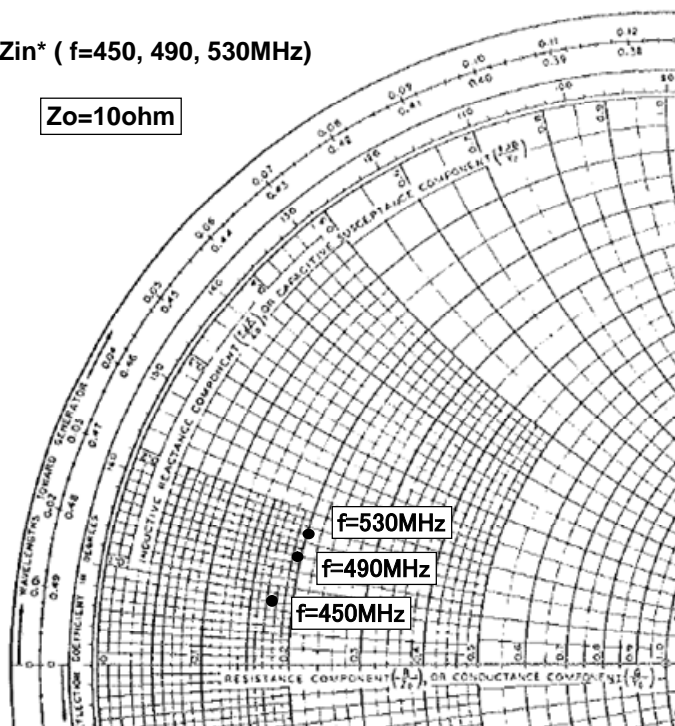

@Pin=3W, Vds=12.5V,
Idq= 0.5A

f (MHz)	Zin* (ohm)
450	1.79+j0.77
490	1.99+j1.38
530	2.06-j1.69

Zin*: Complex conjugate of input impedance

RD35HUF2

RoHS Compliance, Silicon MOSFET Power Transistor, 175MHz, 530MHz, 35W

Small Signal Parameter of RD35HUF2

Bias Condition: Vds=12.5V, Idq=0.5A

Freq [MHz]	S11		S21		S12		S22	
	(mag)	(ang)	(mag)	(ang)	(mag)	(ang)	(mag)	(ang)
100	0.884	-173.6	4.946	71.4	0.010	-15.3	0.829	-173.1
135	0.896	-174.0	3.449	64.9	0.009	-20.1	0.848	-173.1
150	0.903	-174.2	3.020	62.5	0.009	-20.8	0.858	-173.0
175	0.911	-174.5	2.471	58.7	0.008	-23.1	0.872	-173.2
200	0.920	-174.7	2.059	55.1	0.008	-25.0	0.885	-173.4
250	0.933	-175.3	1.473	49.7	0.006	-27.6	0.906	-173.9
300	0.946	-175.8	1.109	45.1	0.005	-27.3	0.922	-174.5
350	0.954	-176.4	0.857	41.9	0.004	-24.3	0.935	-175.0
400	0.958	-177.0	0.687	39.9	0.003	-19.0	0.947	-175.7
450	0.964	-177.5	0.552	37.6	0.003	-8.6	0.954	-176.3
500	0.968	-178.0	0.458	35.5	0.002	8.3	0.960	-177.0
530	0.970	-178.3	0.409	36.4	0.002	20.0	0.965	-177.2
550	0.971	-178.5	0.393	35.9	0.002	32.5	0.966	-177.4
600	0.970	-179.4	0.350	35.5	0.002	54.8	0.966	-178.2
650	0.971	-179.9	0.299	33.7	0.002	72.1	0.968	-178.8
700	0.974	179.4	0.268	34.1	0.003	84.6	0.971	-179.4
750	0.976	178.8	0.240	34.6	0.004	92.8	0.974	179.9
800	0.977	178.1	0.209	34.8	0.004	97.7	0.979	179.2
850	0.975	177.3	0.191	34.0	0.005	102.0	0.978	177.9
900	0.976	176.6	0.179	36.2	0.006	104.0	0.980	177.1
950	0.977	175.7	0.162	35.9	0.006	106.7	0.981	176.4
1000	0.978	174.7	0.152	36.8	0.007	107.9	0.984	175.6
1050	0.979	173.7	0.141	37.1	0.008	110.6	0.986	174.7
1100	0.979	172.7	0.132	39.1	0.009	110.5	0.985	173.7

RD35HUF2

RoHS Compliance, Silicon MOSFET Power Transistor, 175MHz, 530MHz, 35W

ATTENTION:

- 1.High Temperature ; This product might have a heat generation while operation,Please take notice that have a possibility to receive a burn to touch the operating product directly or touch the product until cold after switch off. At the near the product,do not place the combustible material that have possibilities to arise the fire.
- 2.Generation of High Frequency Power ; This product generate a high frequency power. Please take notice that do not leakage the unnecessary electric wave and use this products without cause damage for human and property per normal operation.
- 3.Before use; Before use the product,Please design the equipment in consideration of the risk for human and electric wave obstacle for equipment.

PRECAUTIONS FOR THE USE OF MITSUBISHI SILICON RF POWER DEVICES:

1. The specifications of mention are not guarantee values in this data sheet. Please confirm additional details regarding operation of these products from the formal specification sheet. For copies of the formal specification sheets, please contact one of our sales offices.
- 2.RA series products (RF power amplifier modules) and RD series products (RF power transistors) are designed for consumer mobile communication terminals and were not specifically designed for use in other applications. In particular, while these products are highly reliable for their designed purpose, they are not manufactured under a quality assurance testing protocol that is sufficient to guarantee the level of reliability typically deemed necessary for critical communications elements and In the application, which is base station applications and fixed station applications that operate with long term continuous transmission and a higher on-off frequency during transmitting, please consider the derating, the redundancy system, appropriate setting of the maintain period and others as needed. For the reliability report which is described about predicted operating life time of Mitsubishi Silicon RF Products , please contact Mitsubishi Electric Corporation or an authorized Mitsubishi Semiconductor product distributor.
3. RD series products use MOSFET semiconductor technology. They are sensitive to ESD voltage therefore appropriate ESD precautions are required.
4. In the case of use in below than recommended frequency, there is possibility to occur that the device is deteriorated or destroyed due to the RF-swing exceed the breakdown voltage.
5. In order to maximize reliability of the equipment, it is better to keep the devices temperature low. It is recommended to utilize a sufficient sized heat-sink in conjunction with other cooling methods as needed (fan, etc.) to keep the channel temperature for RD series products lower than 120deg/C(in case of Tchmax=150deg/C) ,140deg/C(in case of Tchmax=175deg/C) under standard conditions.
6. Do not use the device at the exceeded the maximum rating condition. In case of plastic molded devices, the exceeded maximum rating condition may cause blowout, smoldering or catch fire of the molding resin due to extreme short current flow between the drain and the source of the device. These results causes in fire or injury.
7. For specific precautions regarding assembly of these products into the equipment, please refer to the supplementary items in the specification sheet.
8. Warranty for the product is void if the products protective cap (lid) is removed or if the product is modified in any way from it's original form.
9. For additional "Safety first" in your circuit design and notes regarding the materials, please refer the last page of this data sheet.
10. Please refer to the additional precautions in the formal specification sheet.

RD35HUF2

RoHS Compliance, Silicon MOSFET Power Transistor, 175MHz, 530MHz, 35W

Keep safety first in your circuit designs!

Mitsubishi Electric Corporation puts the maximum effort into making semiconductor products better and more reliable, but there is always the possibility that trouble may occur with them. Trouble with semiconductors may lead to personal injury, fire or property damage. Remember to give due consideration to safety when making your circuit designs, with appropriate measures such as (i) placement of substitutive, auxiliary circuits, (ii) use of non-flammable material or (iii) prevention against any malfunction or mishap.

Notes regarding these materials

- These materials are intended as a reference to assist our customers in the selection of the Mitsubishi semiconductor product best suited to the customer's application; they do not convey any license under any intellectual property rights, or any other rights, belonging to Mitsubishi Electric Corporation or a third party.
- Mitsubishi Electric Corporation assumes no responsibility for any damage, or infringement of any third-party's rights, originating in the use of any product data, diagrams, charts, programs, algorithms, or circuit application examples contained in these materials.
- All information contained in these materials, including product data, diagrams, charts, programs and algorithms represents information on products at the time of publication of these materials, and are subject to change by Mitsubishi Electric Corporation without notice due to product improvements or other reasons. It is therefore recommended that customers contact Mitsubishi Electric Corporation or an authorized Mitsubishi Semiconductor product distributor for the latest product information before purchasing a product listed herein.
The information described here may contain technical inaccuracies or typographical errors. Mitsubishi Electric Corporation assumes no responsibility for any damage, liability, or other loss rising from these inaccuracies or errors.
Please also pay attention to information published by Mitsubishi Electric Corporation by various means, including the Mitsubishi Semiconductor home page (<http://www.MitsubishiElectric.com/>).
- When using any or all of the information contained in these materials, including product data, diagrams, charts, programs, and algorithms, please be sure to evaluate all information as a total system before making a final decision on the applicability of the information and products. Mitsubishi Electric Corporation assumes no responsibility for any damage, liability or other loss resulting from the information contained herein.
- Mitsubishi Electric Corporation semiconductors are not designed or manufactured for use in a device or system that is used under circumstances in which human life is potentially at stake. Please contact Mitsubishi Electric Corporation or an authorized Mitsubishi Semiconductor product distributor when considering the use of a product contained herein for any specific purposes, such as apparatus or systems for transportation, vehicular, medical, aerospace, nuclear, or undersea repeater use.
- The prior written approval of Mitsubishi Electric Corporation is necessary to reprint or reproduce in whole or in part these materials.
- If these products or technologies are subject to the Japanese export control restrictions, they must be exported under a license from the Japanese government and cannot be imported into a country other than the approved destination.
Any diversion or re-export contrary to the export control laws and regulations of Japan and/or the country of destination is prohibited.
- Please contact Mitsubishi Electric Corporation or an authorized Mitsubishi Semiconductor product distributor for further details on these materials or the products contained therein.