

# MSA-1105

## Cascadable Silicon Bipolar MMIC Amplifier



### Data Sheet

#### Description

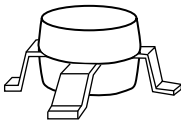
The MSA-1105 is a high performance silicon bipolar Monolithic Microwave Integrated Circuit (MMIC) housed in a low cost, surface mount plastic package. This MMIC is designed for high dynamic range in either 50  $\Omega$  or 75  $\Omega$  systems by combining low noise figure with high IP<sub>3</sub>. Typical applications include narrow and broadband linear amplifiers in commercial and industrial systems.

The MSA-series is fabricated using Avago's 10 GHz  $f_T$ , 25 GHz  $f_{MAX}$  silicon bipolar MMIC process which uses nitride self-alignment, ion implantation, and gold metallization to achieve excellent performance, uniformity and reliability. The use of an external bias resistor for temperature and current stability also allows bias flexibility.

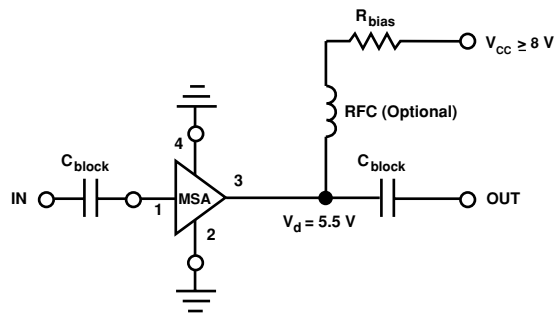
#### Features

- High Dynamic Range Cascadable 50 $\Omega$  or 75 $\Omega$  Gain Block
- 3 dB Bandwidth: 50 MHz to 1.3 GHz
- 17.5 dBm Typical P<sub>1 dB</sub> at 0.5 GHz
- 3.6 dB Typical Noise Figure at 0.5 GHz
- Surface Mount Plastic Package
- Tape-and-Reel Packaging Option Available
- Lead-free Option Available

#### 05 Plastic Package



#### Typical Biasing Configuration



### MSA-1105 Absolute Maximum Ratings

Parameter	Absolute Maximum <sup>[1]</sup>
Device Current	80 mA
Power Dissipation <sup>[2,3]</sup>	550 mW
RF Input Power	+13 dBm
Junction Temperature	150°C
Storage Temperature	-65 to 150°C

### Thermal Resistance<sup>[2]:</sup>

$$\theta_{jc} = 125^{\circ}\text{C/W}$$

#### Notes:

1. Permanent damage may occur if any of these limits are exceeded.
2.  $T_{\text{CASE}} = 25^{\circ}\text{C}$ .
3. Derate at 8 mW/°C for  $T_{\text{C}} > 124^{\circ}\text{C}$ .

### Electrical Specifications<sup>[1]</sup>, $T_{\text{A}} = 25^{\circ}\text{C}$

Symbol	Parameters and Test Conditions: $I_{\text{d}} = 60 \text{ mA}$ , $Z_{\text{o}} = 50 \Omega$	Units	Min.	Typ.	Max.
G <sub>P</sub>	Power Gain ( $ S_{21} ^2$ )	f = 0.05 GHz			12.7
		f = 0.5 GHz	10.0		12.0
		f = 1.0 GHz			10.5
$\Delta G_{\text{P}}$	Gain Flatness	f = 0.1 to 1.0 GHz		±1.0	
f <sub>3 dB</sub>	3 dB Bandwidth <sup>[2]</sup>	GHz		1.3	
VSWR	Input VSWR	f = 0.1 to 1.0 GHz		1.5:1	
	Output VSWR	f = 0.1 to 1.0 GHz		1.7:1	
NF	50 $\Omega$ Noise Figure	f = 0.5 GHz		3.6	
P <sub>1 dB</sub>	Output Power at 1 dB Gain Compression	f = 0.5 GHz		17.5	
IP <sub>3</sub>	Third Order Intercept Point	f = 0.5 GHz		30.0	
t <sub>D</sub>	Group Delay	f = 0.5 GHz		200	
V <sub>d</sub>	Device Voltage	V	4.4	5.5	6.6
dV/dT	Device Voltage Temperature Coefficient	mV/°C		-8.0	

#### Notes:

1. The recommended operating current range for this device is 40 to 70 mA. Typical performance as a function of current is on the following page.
2. Referenced from 50 MHz gain (G<sub>P</sub>).

### Ordering Information

Part Numbers	No. of Devices	Comments
MSA-1105-STR	10	Bulk
MSA-1105-STRG	10	Bulk
MSA-1105-TR1	500	7" Reel
MSA-1105-TR1G	500	7" Reel
MSA-1105-TR2	1500	13" Reel
MSA-1105-TR2G	1500	13" Reel

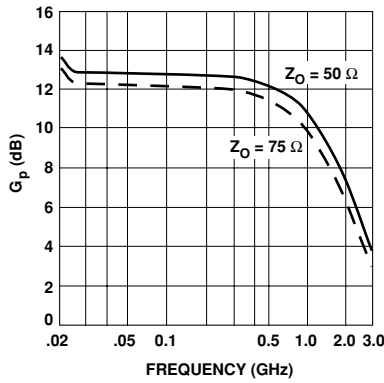
**Note:** Order part number with a "G" suffix if lead-free option is desired.

**MSA-1105 Typical Scattering Parameters ( $Z_0 = 50 \Omega$ ,  $T_A = 25^\circ\text{C}$ ,  $I_d = 60 \text{ mA}$ )**

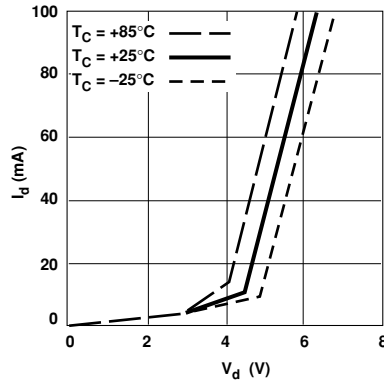
Freq. GHz	S <sub>11</sub>		S <sub>21</sub>			S <sub>12</sub>			S <sub>22</sub>		k
	Mag	Ang	dB	Mag	Ang	dB	Mag	Ang	Mag	Ang	
.0005	.80	-17	19.0	8.94	171	-26.0	.050	51	.81	-16	0.53
.005	.26	-62	13.9	4.98	163	-16.8	.144	15	.26	-64	0.93
.025	.07	-48	12.8	4.36	174	-16.4	.151	4	.08	-52	1.08
.050	.06	-38	12.7	4.33	174	-16.3	.153	2	.06	-48	1.08
.100	.05	-41	12.7	4.31	170	-16.4	.152	3	.06	-52	1.09
.200	.06	-58	12.6	4.26	162	-16.2	.155	5	.08	-73	1.08
.300	.07	-74	12.4	4.19	154	-16.1	.157	7	.10	-91	1.07
.400	.09	-91	12.2	4.10	146	-15.8	.163	8	.12	-105	1.06
.500	.10	-105	12.0	4.00	138	-15.6	.166	8	.14	-116	1.05
.600	.11	-116	11.8	3.88	131	-15.4	.171	10	.17	-126	1.04
.700	.13	-128	11.5	3.76	123	-15.0	.178	11	.18	-135	1.03
.800	.15	-136	11.2	3.63	116	-14.7	.184	11	.21	-144	1.01
.900	.16	-145	10.9	3.49	109	-15.5	.188	11	.22	-151	1.01
1.000	.18	-152	10.5	3.37	102	-14.1	.197	11	.24	-159	1.00
1.500	.28	174	8.8	2.75	72	-13.2	.219	7	.31	170	1.00
2.000	.38	150	7.1	2.28	48	-12.1	.248	0	.34	151	0.99
2.500	.46	133	5.6	1.90	28	-11.9	.254	-4	.38	134	1.02
3.000	.53	118	4.2	1.62	11	-11.6	.262	-8	.40	122	1.04

**Typical Performance,  $T_A = 25^\circ\text{C}$ ,  $Z_0 = 50 \Omega$**

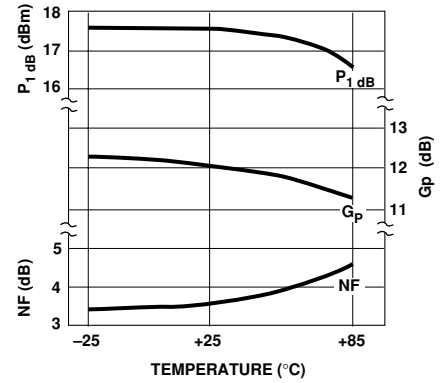
(unless otherwise noted)



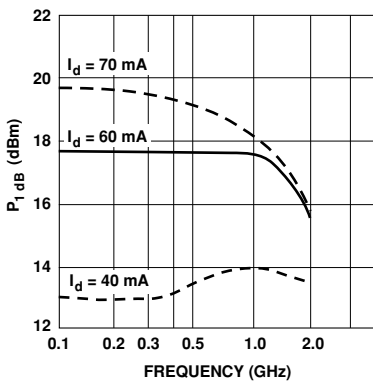
**Figure 1. Typical Power Gain vs. Frequency,  $I_d = 60 \text{ mA}$ .**



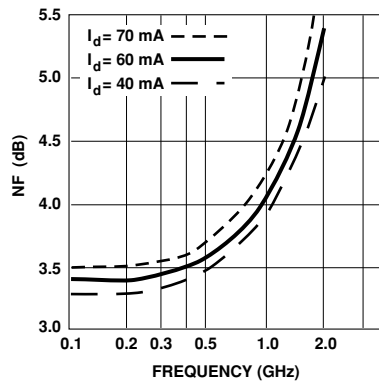
**Figure 2. Device Current vs. Voltage.**



**Figure 3. Output Power at 1 dB Gain Compression, Noise Figure and Power Gain vs. Case Temperature,  $f = 0.5 \text{ GHz}$ ,  $I_d = 60 \text{ mA}$ .**

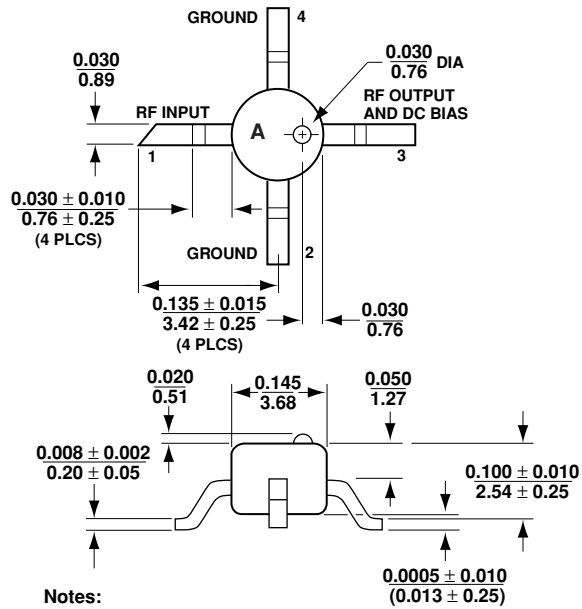


**Figure 4. Output Power at 1 dB Gain Compression vs. Frequency.**



**Figure 5. Noise Figure vs. Frequency.**

## 05 Plastic Package Dimensions



**Notes:**

(unless otherwise specified)

1. Dimensions are  $\frac{\text{in}}{\text{mm}}$
2. Tolerances  
in .xxx =  $\pm 0.005$   
mm .xx =  $\pm 0.13$

For product information and a complete list of distributors, please go to our web site:

[www.avagotech.com](http://www.avagotech.com)

Avago, Avago Technologies, and the A logo are trademarks of Avago Technologies, Limited in the United States and other countries.

Data subject to change. Copyright © 2006 Avago Technologies, Limited. All rights reserved.

Obsoletes 5965-9557EN

5989-2746EN May 8, 2006

**AVAGO**  
TECHNOLOGIES