

# MJW21195 (PNP) MJW21196 (NPN)

## Silicon Power Transistors

The MJW21195 and MJW21196 utilize Perforated Emitter technology and are specifically designed for high power audio output, disk head positioners and linear applications.

### Features

- Total Harmonic Distortion Characterized
- High DC Current Gain –  $h_{FE} = 20 \text{ Min @ } I_C = 8 \text{ A dc}$
- Excellent Gain Linearity
- High SOA: 2.25 A, 80 V, 1 Second
- Pb-Free Packages are Available\*

### MAXIMUM RATINGS

Rating	Symbol	Value	Unit
Collector-Emitter Voltage	$V_{CEO}$	250	Vdc
Collector-Base Voltage	$V_{CBO}$	400	Vdc
Emitter-Base Voltage	$V_{EBO}$	5.0	Vdc
Collector-Emitter Voltage – 1.5 V	$V_{CEX}$	400	Vdc
Collector Current – Continuous – Peak (Note 1)	$I_C$	16 30	A dc
Base Current – Continuous	$I_B$	5.0	A dc
Total Power Dissipation @ $T_C = 25^\circ\text{C}$ Derate Above $25^\circ\text{C}$	$P_D$	200 1.43	W W/ $^\circ\text{C}$
Operating and Storage Junction Temperature Range	$T_J, T_{stg}$	-65 to +150	$^\circ\text{C}$

### THERMAL CHARACTERISTICS

Characteristic	Symbol	Max	Unit
Thermal Resistance, Junction-to-Case	$R_{\theta JC}$	0.7	$^\circ\text{C/W}$
Thermal Resistance, Junction-to-Ambient	$R_{\theta JA}$	40	$^\circ\text{C/W}$

Stresses exceeding Maximum Ratings may damage the device. Maximum Ratings are stress ratings only. Functional operation above the Recommended Operating Conditions is not implied. Extended exposure to stresses above the Recommended Operating Conditions may affect device reliability.

1. Pulse Test: Pulse Width = 5  $\mu\text{s}$ , Duty Cycle  $\leq 10\%$ .



**ON Semiconductor®**

<http://onsemi.com>

**16 AMPERES  
COMPLEMENTARY  
SILICON POWER TRANSISTORS  
250 VOLTS, 200 WATTS**

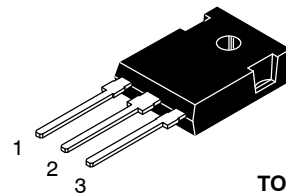

**TO-247  
CASE 340L**

### MARKING DIAGRAM

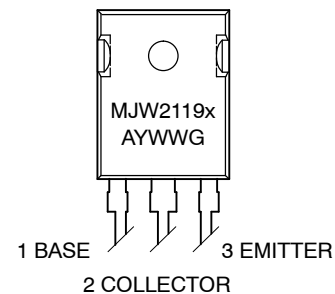

x = 5 or 6  
A = Assembly Location  
Y = Year  
WW = Work Week  
G = Pb-Free Package

### ORDERING INFORMATION

Device	Package	Shipping
MJW21195	TO-247	30 Units/Rail
MJW21195G	TO-247 (Pb-Free)	30 Units/Rail
MJW21196	TO-247	30 Units/Rail
MJW21196G	TO-247 (Pb-Free)	30 Units/Rail

\*For additional information on our Pb-Free strategy and soldering details, please download the ON Semiconductor Soldering and Mounting Techniques Reference Manual, SOLDERRM/D.

## MJW21195 (PNP) MJW21196 (NPN)

### ELECTRICAL CHARACTERISTICS (T<sub>C</sub> = 25°C unless otherwise noted)

Characteristic	Symbol	Min	Typical	Max	Unit	
<b>OFF CHARACTERISTICS</b>						
Collector-Emitter Sustaining Voltage (I <sub>C</sub> = 100 mAdc, I <sub>B</sub> = 0)	V <sub>CEO(sus)</sub>	250	–	–	Vdc	
Collector Cutoff Current (V <sub>CE</sub> = 200 Vdc, I <sub>B</sub> = 0)	I <sub>CEO</sub>	–	–	100	μAdc	
Emitter Cutoff Current (V <sub>CE</sub> = 5 Vdc, I <sub>C</sub> = 0)	I <sub>EBO</sub>	–	–	50	μAdc	
Collector Cutoff Current (V <sub>CE</sub> = 250 Vdc, V <sub>BE(off)</sub> = 1.5 Vdc)	I <sub>CEX</sub>	–	–	50	μAdc	
<b>SECOND BREAKDOWN</b>						
Second Breakdown Collector Current with Base Forward Biased (V <sub>CE</sub> = 50 Vdc, t = 1 s (non-repetitive)) (V <sub>CE</sub> = 80 Vdc, t = 1 s (non-repetitive))	I <sub>S/b</sub>	4.0 2.25	– –	– –	Adc	
<b>ON CHARACTERISTICS</b>						
DC Current Gain (I <sub>C</sub> = 8 Adc, V <sub>CE</sub> = 5 Vdc) (I <sub>C</sub> = 16 Adc, I <sub>B</sub> = 5 Adc)	h <sub>FE</sub>	20 8	– –	80 –		
Base-Emitter On Voltage (I <sub>C</sub> = 8 Adc, V <sub>CE</sub> = 5 Vdc)	V <sub>BE(on)</sub>	–	–	2.0	Vdc	
Collector-Emitter Saturation Voltage (I <sub>C</sub> = 8 Adc, I <sub>B</sub> = 0.8 Adc) (I <sub>C</sub> = 16 Adc, I <sub>B</sub> = 3.2 Adc)	V <sub>CE(sat)</sub>	– –	– –	1.0 3	Vdc	
<b>DYNAMIC CHARACTERISTICS</b>						
Total Harmonic Distortion at the Output V <sub>RMS</sub> = 28.3 V, f = 1 kHz, P <sub>LOAD</sub> = 100 W <sub>RMS</sub> (Matched pair h <sub>FE</sub> = 50 @ 5 A/5 V)	h <sub>FE</sub> unmatched h <sub>FE</sub> matched	T <sub>HD</sub>	– –	0.8 0.08	– –	%
Current Gain Bandwidth Product (I <sub>C</sub> = 1 Adc, V <sub>CE</sub> = 10 Vdc, f <sub>test</sub> = 1 MHz)	f <sub>T</sub>	4	–	–	MHz	
Output Capacitance (V <sub>CB</sub> = 10 Vdc, I <sub>E</sub> = 0, f <sub>test</sub> = 1 MHz)	C <sub>ob</sub>	–	–	500	pF	

# MJW21195 (PNP) MJW21196 (NPN)

## TYPICAL CHARACTERISTICS

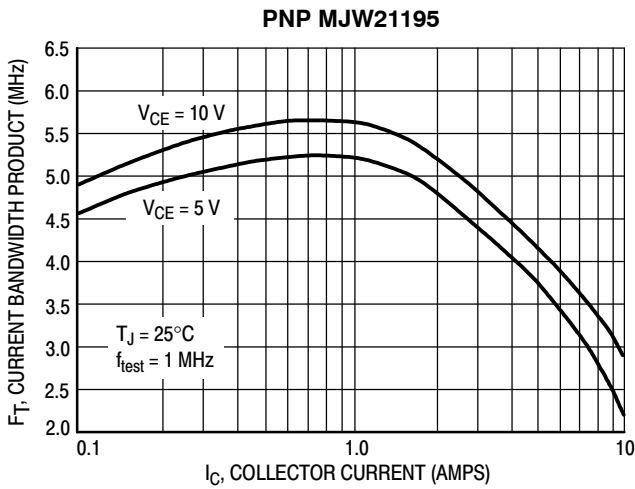

**Figure 1. Typical Current Gain Bandwidth Product**

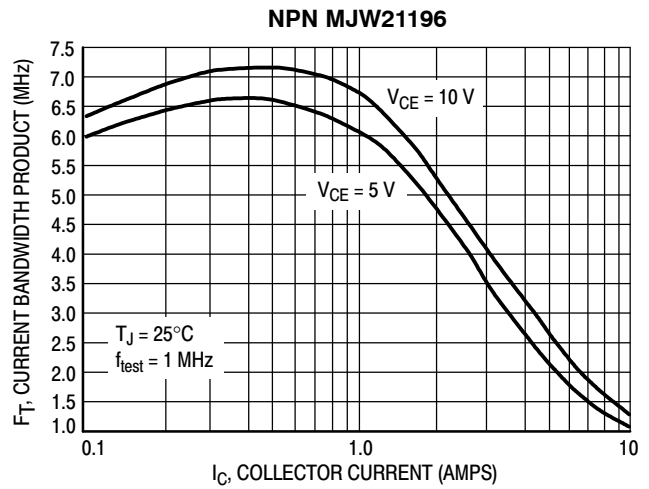

**Figure 2. Typical Current Gain Bandwidth Product**

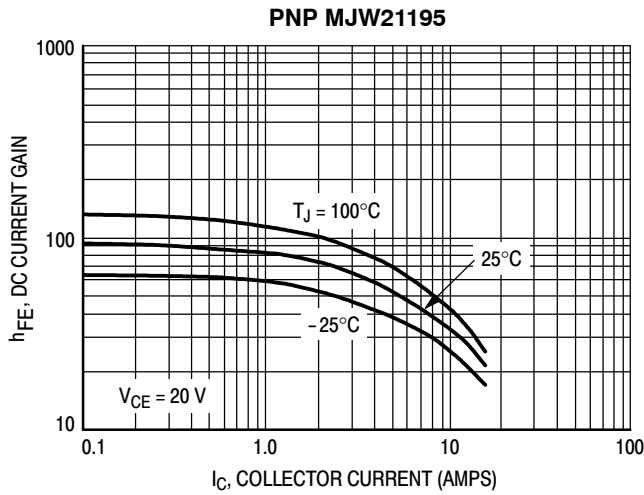

**Figure 3. DC Current Gain,  $V_{CE} = 20\text{ V}$**

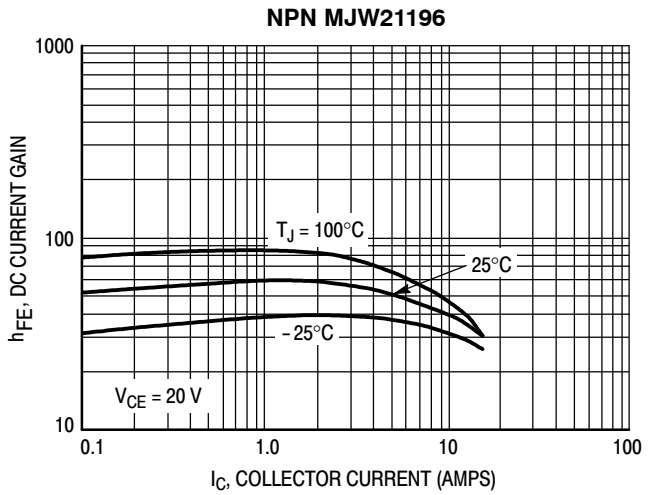

**Figure 4. DC Current Gain,  $V_{CE} = 20\text{ V}$**

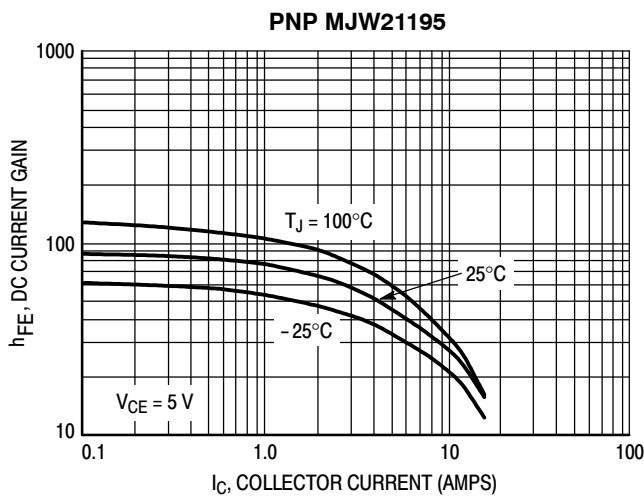

**Figure 5. DC Current Gain,  $V_{CE} = 5\text{ V}$**

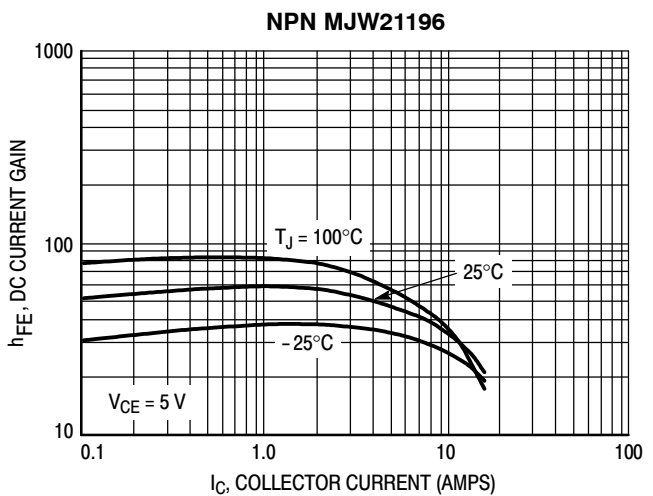

**Figure 6. DC Current Gain,  $V_{CE} = 5\text{ V}$**

# MJW21195 (PNP) MJW21196 (NPN)

## TYPICAL CHARACTERISTICS

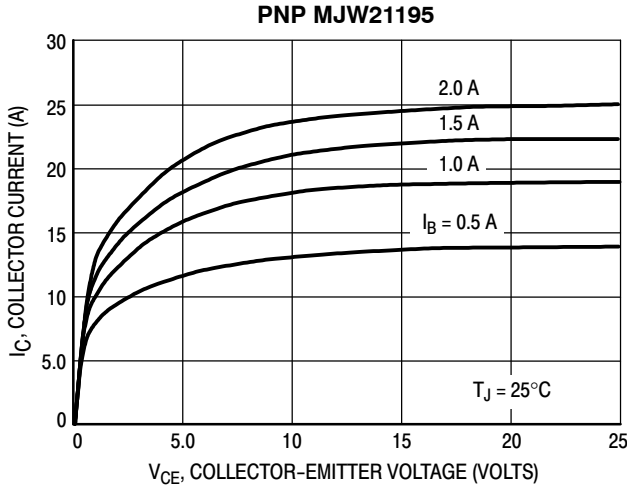

Figure 7. Typical Output Characteristics

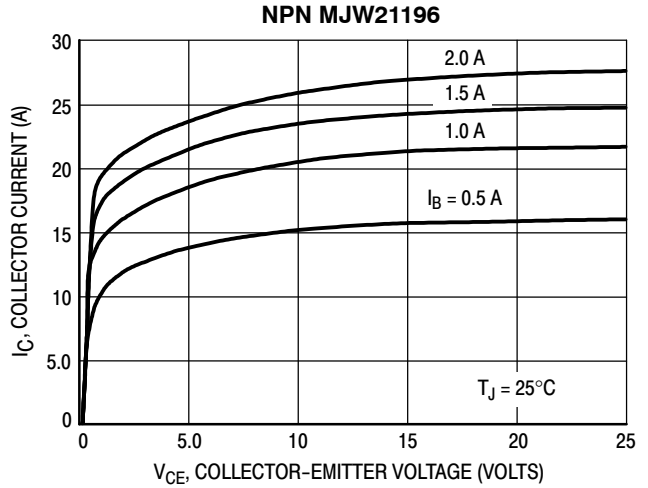

Figure 8. Typical Output Characteristics

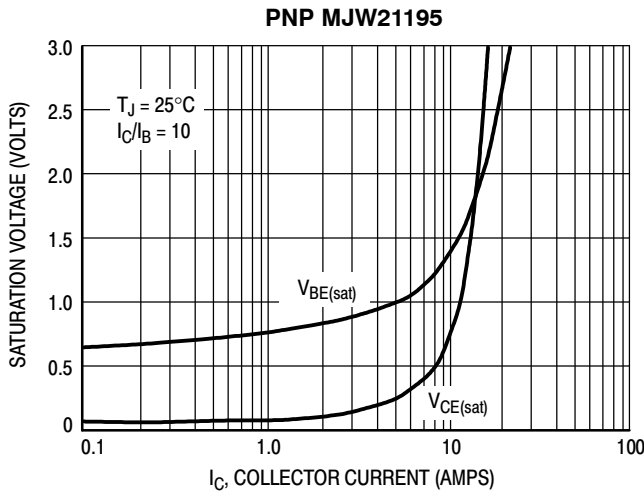

Figure 9. Typical Saturation Voltages

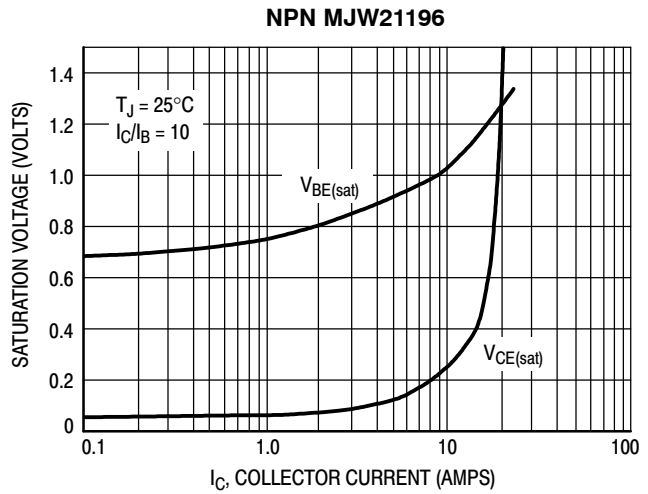

Figure 10. Typical Saturation Voltages

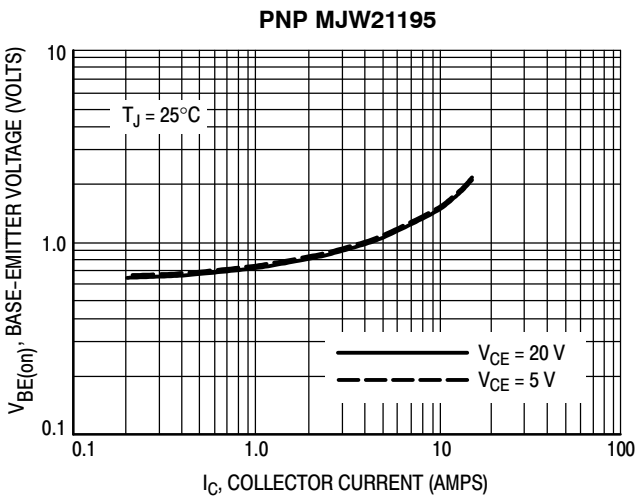

Figure 11. Typical Base-Emitter Voltage

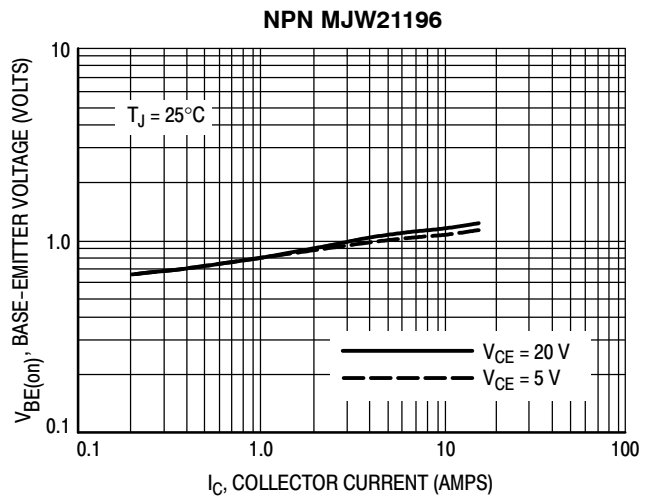

Figure 12. Typical Base-Emitter Voltage

## MJW21195 (PNP) MJW21196 (NPN)

There are two limitations on the power handling ability of a transistor; average junction temperature and secondary breakdown. Safe operating area curves indicate  $I_C - V_{CE}$  limits of the transistor that must be observed for reliable operation; i.e., the transistor must not be subjected to greater dissipation than the curves indicate.

The data of Figure 13 is based on  $T_{J(pk)} = 150^\circ\text{C}$ ;  $T_C$  is variable depending on conditions. At high case temperatures, thermal limitations will reduce the power than can be handled to values less than the limitations imposed by second breakdown.

### TYPICAL CHARACTERISTICS

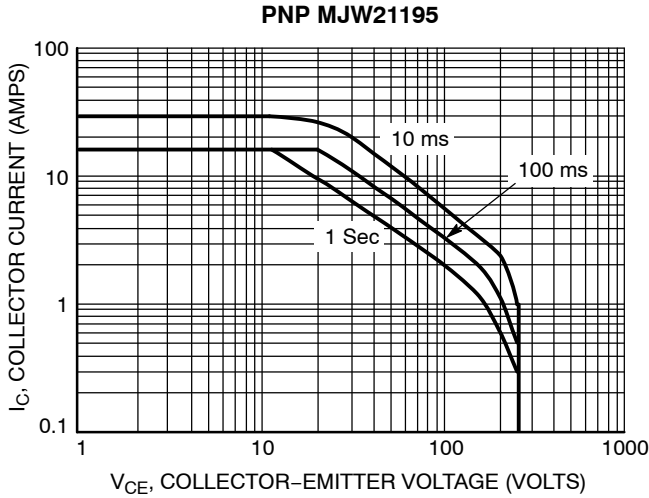

Figure 13. Active Region Safe Operating Area

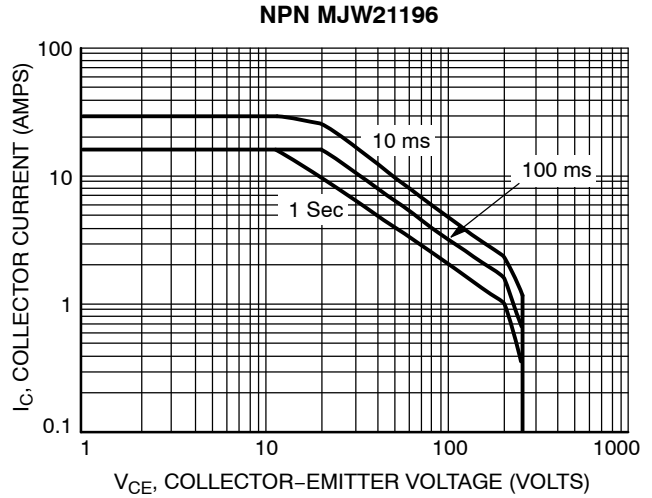

Figure 14. Active Region Safe Operating Area

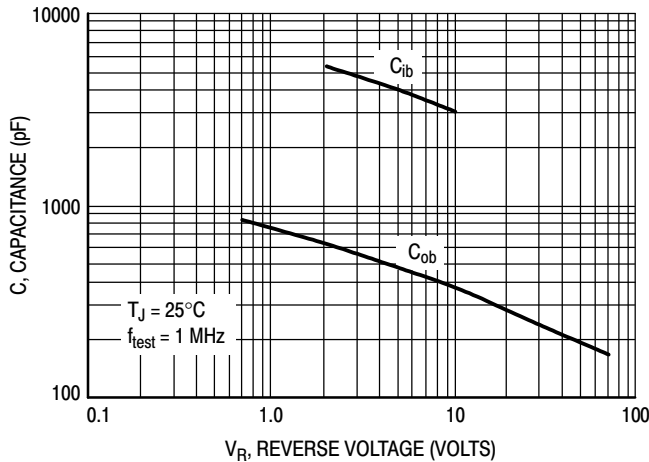

Figure 15. MJW21195 Typical Capacitance

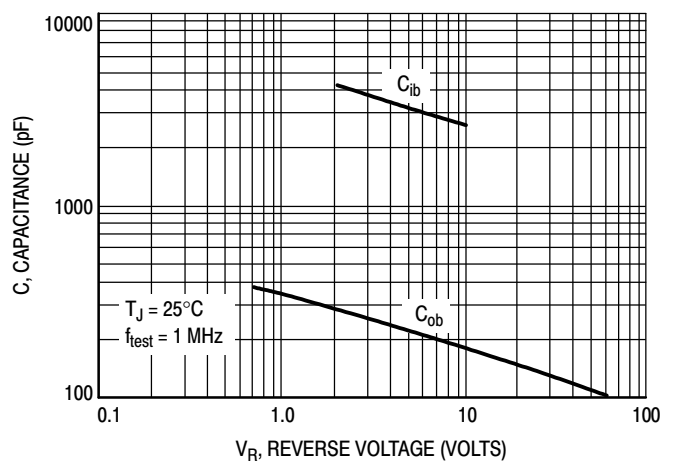

Figure 16. MJW21196 Typical Capacitance

## MJW21195 (PNP) MJW21196 (NPN)

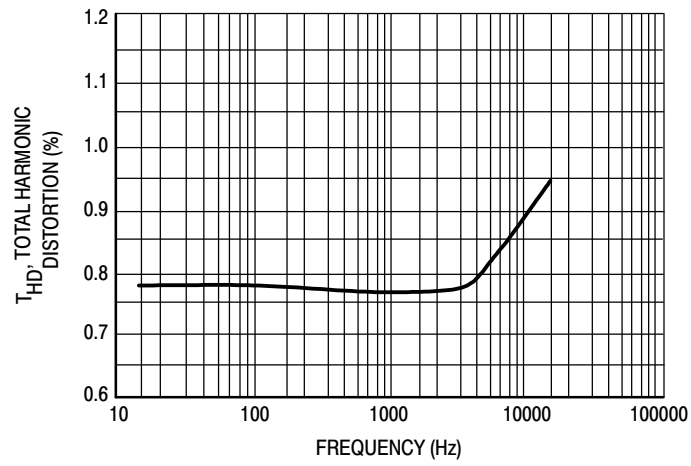

Figure 17. Typical Total Harmonic Distortion

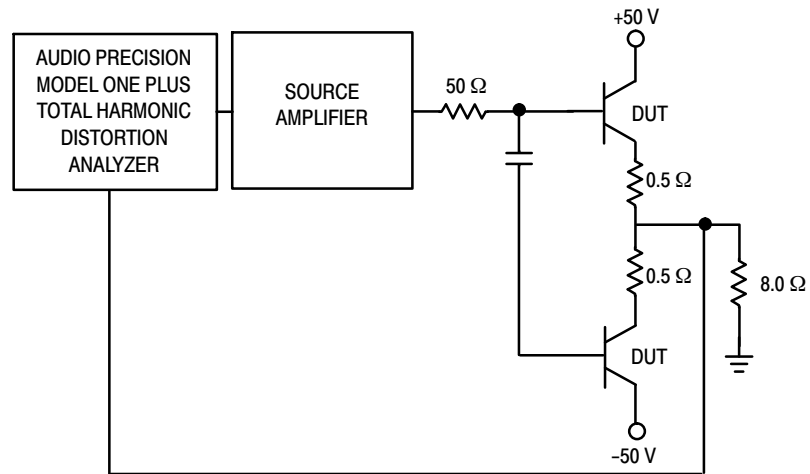

Figure 18. Total Harmonic Distortion Test Circuit

# MECHANICAL CASE OUTLINE PACKAGE DIMENSIONS



TO-247  
CASE 340L  
ISSUE G

DATE 06 OCT 2021

SCALE 1:1

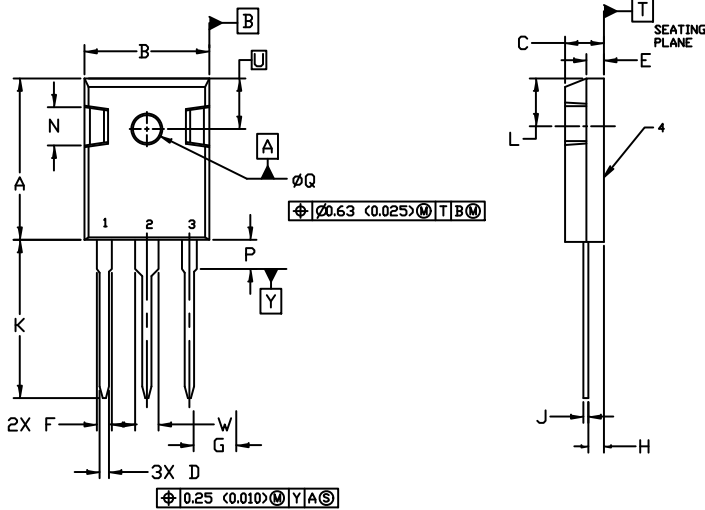

NOTES:

1. DIMENSIONING AND TOLERANCING PER ASME Y14.5M, 1982.
2. CONTROLLING DIMENSION: MILLIMETER

DIM	MILLIMETERS		INCHES	
	MIN.	MAX.	MIN.	MAX.
A	20.32	21.08	0.800	0.830
B	15.75	16.26	0.620	0.640
C	4.70	5.30	0.185	0.209
D	1.00	1.40	0.040	0.055
E	1.90	2.60	0.075	0.102
F	1.65	2.13	0.065	0.084
G	5.45 BSC		0.215 BSC	
H	1.50	2.49	0.059	0.098
J	0.40	0.80	0.016	0.031
K	19.81	20.83	0.780	0.820
L	5.40	6.20	0.212	0.244
N	4.32	5.49	0.170	0.216
P	----	4.50	----	0.177
Q	3.55	3.65	0.140	0.144
U	6.15 BSC		0.242 BSC	
W	2.87	3.12	0.113	0.123

GENERIC  
MARKING DIAGRAM\*

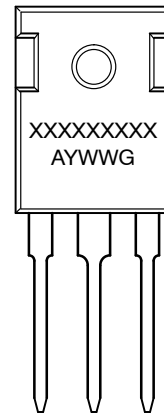

- |  |  |  |  |
|--|--|--|--|
| <p>STYLE 1:<br/>PIN 1. GATE<br/>2. DRAIN<br/>3. SOURCE<br/>4. DRAIN</p>  | <p>STYLE 2:<br/>PIN 1. ANODE<br/>2. CATHODE (S)<br/>3. ANODE 2<br/>4. CATHODES (S)</p>               | <p>STYLE 3:<br/>PIN 1. BASE<br/>2. COLLECTOR<br/>3. EMITTER<br/>4. COLLECTOR</p> | <p>STYLE 4:<br/>PIN 1. GATE<br/>2. COLLECTOR<br/>3. EMITTER<br/>4. COLLECTOR</p> |
| <p>STYLE 5:<br/>PIN 1. CATHODE<br/>2. ANODE<br/>3. GATE<br/>4. ANODE</p> | <p>STYLE 6:<br/>PIN 1. MAIN TERMINAL 1<br/>2. MAIN TERMINAL 2<br/>3. GATE<br/>4. MAIN TERMINAL 2</p> |  |  |

- XXXXX = Specific Device Code  
A = Assembly Location  
Y = Year  
WW = Work Week  
G = Pb-Free Package

\*This information is generic. Please refer to device data sheet for actual part marking. Pb-Free indicator, "G" or microdot "▪", may or may not be present. Some products may not follow the Generic Marking.

DOCUMENT NUMBER:	98ASB15080C	Electronic versions are uncontrolled except when accessed directly from the Document Repository. Printed versions are uncontrolled except when stamped "CONTROLLED COPY" in red.
DESCRIPTION:	TO-247	PAGE 1 OF 1

onsemi and ONSEMI are trademarks of Semiconductor Components Industries, LLC dba onsemi or its subsidiaries in the United States and/or other countries. onsemi reserves the right to make changes without further notice to any products herein. onsemi makes no warranty, representation or guarantee regarding the suitability of its products for any particular purpose, nor does onsemi assume any liability arising out of the application or use of any product or circuit, and specifically disclaims any and all liability, including without limitation special, consequential or incidental damages. onsemi does not convey any license under its patent rights nor the rights of others.

**onsemi**, **Onsemi**, and other names, marks, and brands are registered and/or common law trademarks of Semiconductor Components Industries, LLC dba "**onsemi**" or its affiliates and/or subsidiaries in the United States and/or other countries. **onsemi** owns the rights to a number of patents, trademarks, copyrights, trade secrets, and other intellectual property. A listing of **onsemi**'s product/patent coverage may be accessed at [www.onsemi.com/site/pdf/Patent-Marking.pdf](http://www.onsemi.com/site/pdf/Patent-Marking.pdf). **onsemi** reserves the right to make changes at any time to any products or information herein, without notice. The information herein is provided "as-is" and **onsemi** makes no warranty, representation or guarantee regarding the accuracy of the information, product features, availability, functionality, or suitability of its products for any particular purpose, nor does **onsemi** assume any liability arising out of the application or use of any product or circuit, and specifically disclaims any and all liability, including without limitation special, consequential or incidental damages. Buyer is responsible for its products and applications using **onsemi** products, including compliance with all laws, regulations and safety requirements or standards, regardless of any support or applications information provided by **onsemi**. "Typical" parameters which may be provided in **onsemi** data sheets and/or specifications can and do vary in different applications and actual performance may vary over time. All operating parameters, including "Typicals" must be validated for each customer application by customer's technical experts. **onsemi** does not convey any license under any of its intellectual property rights nor the rights of others. **onsemi** products are not designed, intended, or authorized for use as a critical component in life support systems or any FDA Class 3 medical devices or medical devices with a same or similar classification in a foreign jurisdiction or any devices intended for implantation in the human body. Should Buyer purchase or use **onsemi** products for any such unintended or unauthorized application, Buyer shall indemnify and hold **onsemi** and its officers, employees, subsidiaries, affiliates, and distributors harmless against all claims, costs, damages, and expenses, and reasonable attorney fees arising out of, directly or indirectly, any claim of personal injury or death associated with such unintended or unauthorized use, even if such claim alleges that **onsemi** was negligent regarding the design or manufacture of the part. **onsemi** is an Equal Opportunity/Affirmative Action Employer. This literature is subject to all applicable copyright laws and is not for resale in any manner.

## PUBLICATION ORDERING INFORMATION

### LITERATURE FULFILLMENT:

Email Requests to: [orderlit@onsemi.com](mailto:orderlit@onsemi.com)

**onsemi Website:** [www.onsemi.com](http://www.onsemi.com)

### TECHNICAL SUPPORT

**North American Technical Support:**

Voice Mail: 1 800-282-9855 Toll Free USA/Canada

Phone: 011 421 33 790 2910

**Europe, Middle East and Africa Technical Support:**

Phone: 00421 33 790 2910

For additional information, please contact your local Sales Representative