

T-33-01

**MOTOROLA
SEMICONDUCTOR
TECHNICAL DATA**

**PT9730
Series**

**The RF Line
VHF Power Transistors**

... designed primarily for wideband, large-signal output amplifier stages in the 30-200 MHz frequency range.

- Guaranteed Performance at 175 MHz, 28 Vdc
Output Power — 4 to 25 Watts
Minimum Gain — 10 to 13 dB
Collector Efficiency — 60%, Min
- 100% Tested for Load Mismatch at All Phase Angles with 30:1 VSWR
- Gold Metallization for Improved Reliability
- Diffused Ballast Resistors

TO 200 MHz
4 TO 25 WATTS
VHF POWER
TRANSISTORS
NPN SILICON

2

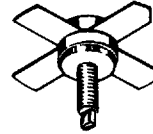

CASE 145D-01, STYLE 1
(.380 SOE)

MAXIMUM RATINGS

Rating	Symbol	9730	9732	9734	9731	Unit
Collector-Emitter Voltage	V _{CEO}	35				Vdc
Collector-Base Voltage	V _{CES}	60				Vdc
Emitter-Base Voltage	V _{EBO}	4				Vdc
Collector Current — Continuous	I _C	1	1.25	2.5	4	Adc
Total Device Dissipation († T _C = 25°C Derate above 25°C)	P _D	10 0.06	20 0.114	30 0.173	45 0.257	Watts W/C
Operating Junction Temperature	T _J	200				°C
Storage Temperature Range	T _{stg}	-65 to +150				°C

THERMAL CHARACTERISTICS

Characteristic	Symbol	Max				Unit
Thermal Resistance, Junction to Case	R _{θJC}	17.5	8.8	5.8	3.9	°C/W

ELECTRICAL CHARACTERISTICS

Characteristic	Symbol	Min	Typ	Max	Unit
----------------	--------	-----	-----	-----	------

OFF CHARACTERISTICS

Collector-Emitter Breakdown Voltage (I _C = 25 mA, I _B = 0)	V(BR)CEO	35	—	—	Vdc
Collector-Emitter Breakdown Voltage (I _C = 50 mA, V _{BE} = 0)	V(BR)CES	60	—	—	Vdc
Emitter-Base Breakdown Voltage (I _E = 1 mA, I _C = 0)	V(BR)EBO	4	—	—	Vdc
Collector Cutoff Current (V _{CE} = 25 V, V _{BE} = 0)	I _{CES}	—	—	0.5 1 1.5 2	mAdc
	PT9730				
	PT9732				
	PT9734				
	PT9731				

ON CHARACTERISTICS

DC Current Gain (I _C = 500 mA, V _{CE} = 10 V)	h _{FE}	20	—	150	—
---	-----------------	----	---	-----	---

DYNAMIC CHARACTERISTICS

Output Capacitance (V _{CB} = 28 V, I _E = 0, f = 1 MHz)	C _{ob}	—	—	12 18 24 40	pF
	PT9730				
	PT9732				
	PT9734				
	PT9731				

(continued)

ELECTRICAL CHARACTERISTICS — continued

Characteristic	Symbol	Min	Typ	Max	Unit
FUNCTIONAL TESTS					
Common-Emitter Amplifier Power Gain ($V_{CE} = 28\text{ V}$, $P_{out} = \text{Rated}$, $f = 175\text{ MHz}$)	PT9730	13	—	—	dB
	PT9732	12	—	—	
	PT9734	11.8	—	—	
	PT9731	10	—	—	
Collector Efficiency ($V_{CE} = 28\text{ V}$, $P_{out} = \text{Rated}$, $f = 175\text{ MHz}$)	η_c	60	—	—	%
Load Mismatch ($V_{CE} = 28\text{ V}$, $P_{out} = \text{Rated}$, $f = 175\text{ MHz}$, Load VSWR = $\infty:1$, All Phase Angles)	\downarrow	No Degradation in Output Power			
Saturated Output Power ($V_{CE} = 28\text{ V}$, $f = 175\text{ MHz}$)	PT9730	6	—	—	W
	PT9732	10	—	—	
	PT9734	18	—	—	
	PT9731	30	—	—	

TYPICAL CHARACTERISTICS
PT9730 — 4 WATTS

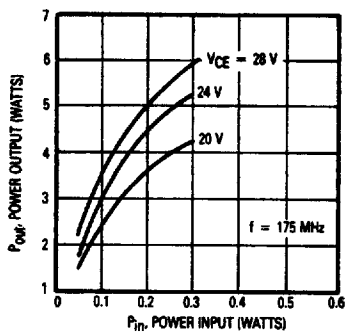

Figure 1. Power Input versus Power Output

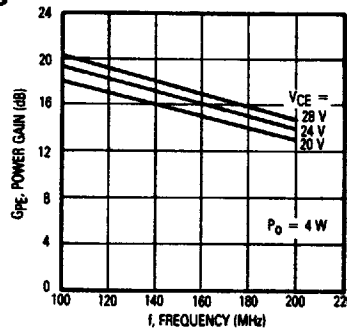

Figure 2. Power Gain versus Frequency

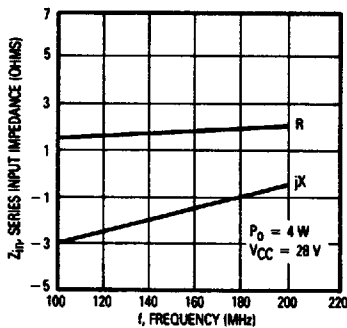

Figure 3. Series Input Impedance versus Frequency

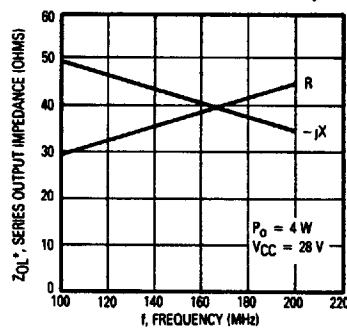

Figure 4. Series Output Impedance versus Frequency

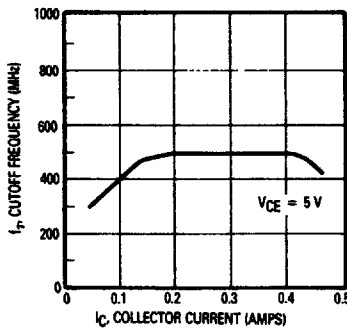

Figure 5. Cutoff Frequency versus Current

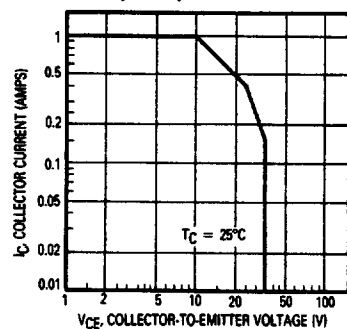

Figure 6. Safe Operating Area

TYPICAL CHARACTERISTICS
PT9732 — 8 WATTS

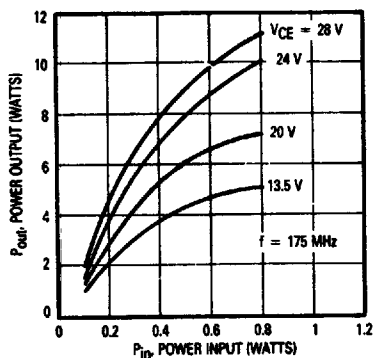

Figure 7. Power Output versus Power Input

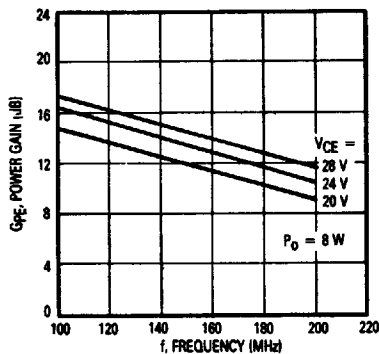

Figure 8. Power Gain versus Frequency

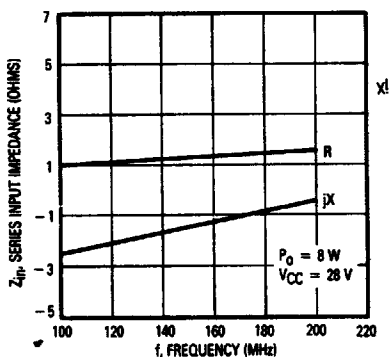

Figure 9. Series Input Impedance versus Frequency

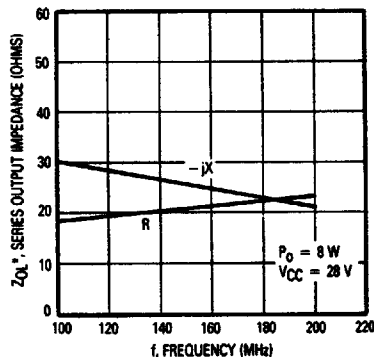

Figure 10. Series Output Impedance versus Frequency

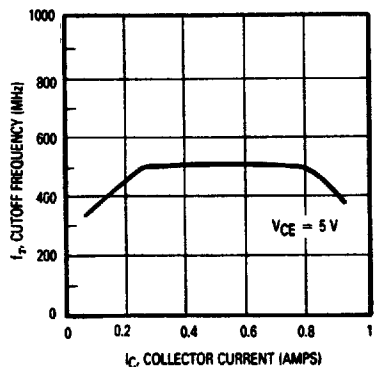

Figure 11. Cutoff Frequency versus Current

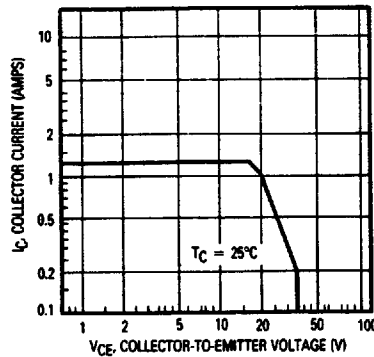

Figure 12. Safe Operating Area

2

TYPICAL CHARACTERISTICS
PT9734 — 15 WATTS

2

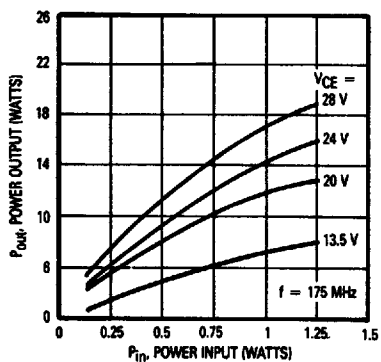

Figure 13. Power Output versus Power Input

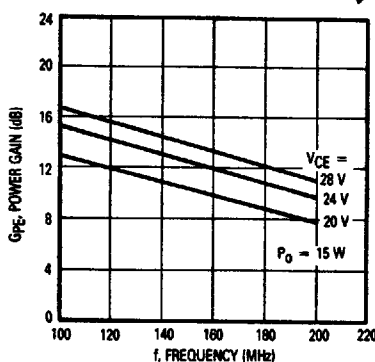

Figure 14. Power Gain versus Frequency

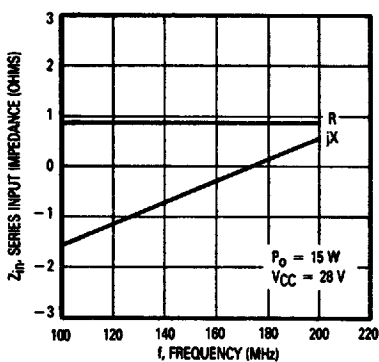

Figure 15. Series Input Impedance versus Frequency

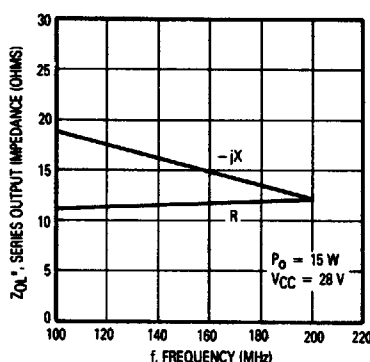

Figure 16. Series Output Impedance versus Frequency

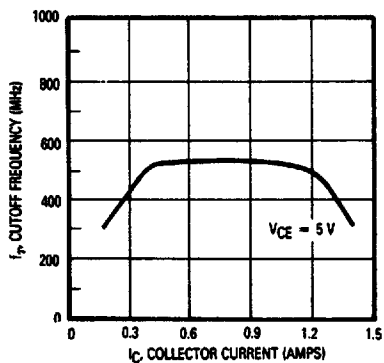

Figure 17. Cutoff Frequency versus Current

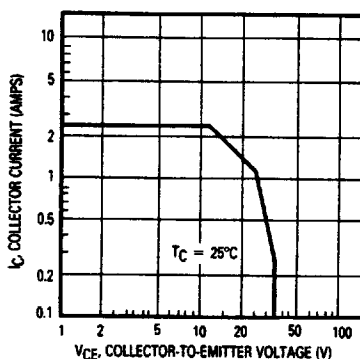

Figure 18. Safe Operating Area

TYPICAL CHARACTERISTICS
PT9731 — 25 WATTS

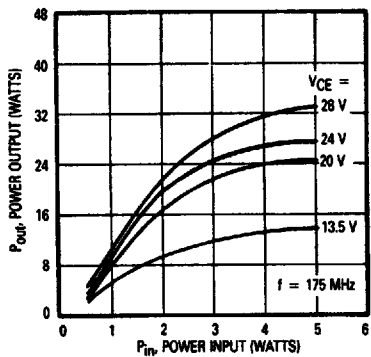

Figure 19. Power Output versus Power Input

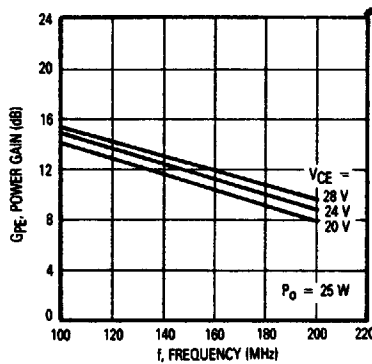

Figure 20. Power Gain versus Frequency

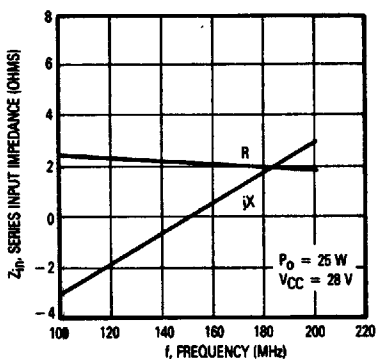

Figure 21. Series Input Impedance versus Frequency

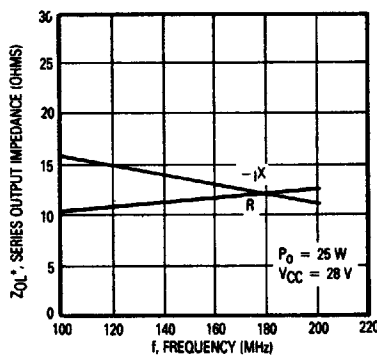

Figure 22. Series Output Impedance versus Frequency

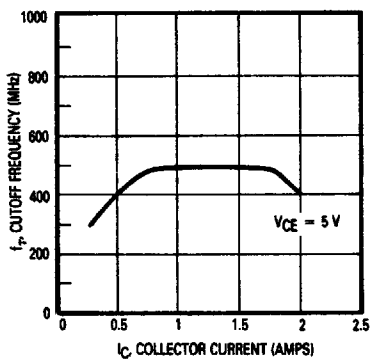

Figure 23. Cutoff Frequency versus Current

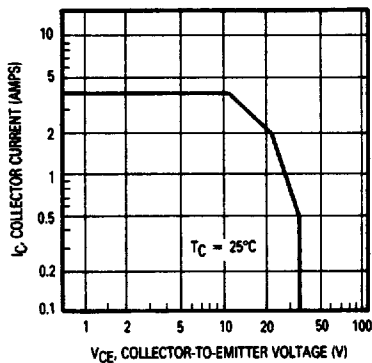

Figure 24. Safe Operating Area

2

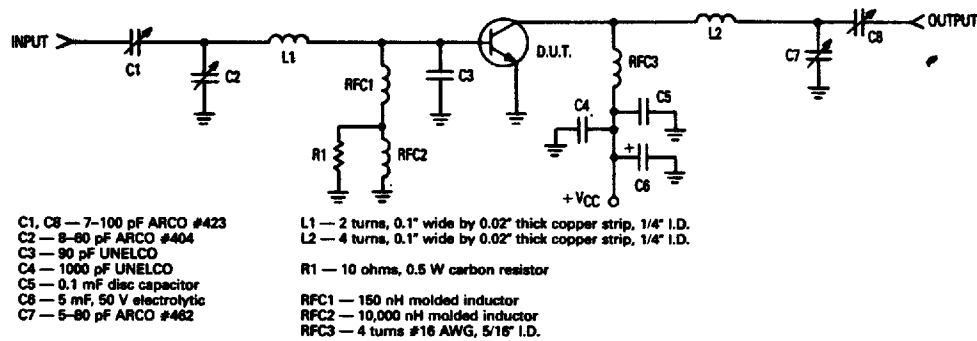

Figure 25. 175 MHz Test Circuit (PT9731)

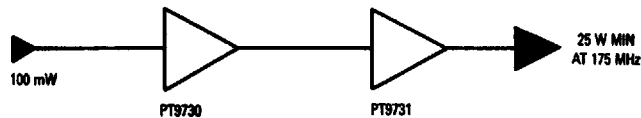
Figure 26. Typical Application
25 Watt VHF 24 V Power Amplifier

Figure 27. 175 MHz Test Circuit (PT9730 and PT9732)

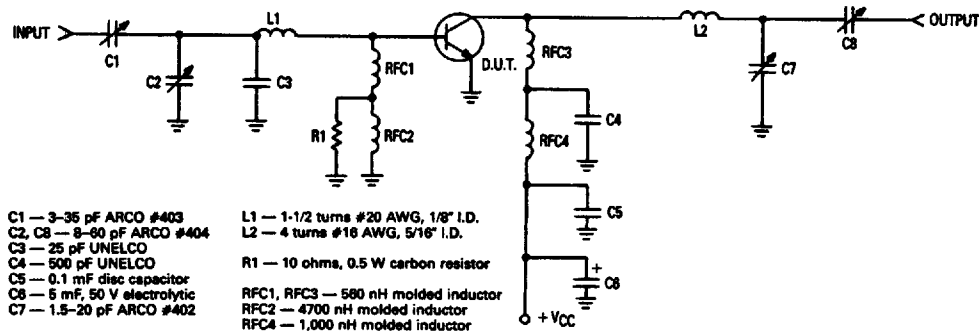
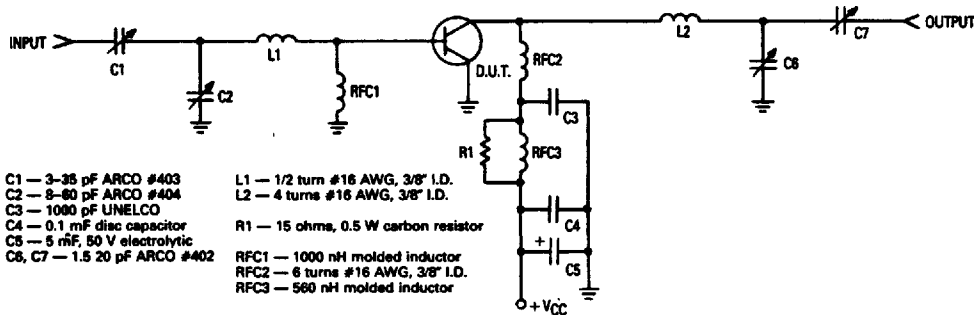

Figure 28. 175 MHz Test Circuit (PT9734)