

# MSA-0486

## Cascadable Silicon Bipolar MMIC Amplifier



### Data Sheet

#### Description

The MSA-0486 is a high performance silicon bipolar Monolithic Microwave Integrated Circuit (MMIC) housed in a low cost, surface mount plastic package. This MMIC is designed for use as a general purpose 50Ω gain block. Typical applications include narrow and broad band IF and RF amplifiers in commercial and industrial applications.

The MSA-series is fabricated using Avago's 10 GHz  $f_T$ , 25 GHz  $f_{MAX}$ , silicon bipolar MMIC process which uses nitride self-alignment, ion implantation, and gold metallization to achieve excellent performance, uniformity and reliability. The use of an external bias resistor for temperature and current stability also allows bias flexibility.

#### Features

- Lead-free Option Available
- Cascadable 50 Ω Gain Block
- 3 dB Bandwidth: DC to 3.2 GHz
- 8 dB Typical Gain at 1.0 GHz
- 12.5 dBm Typical  $P_{1\text{ dB}}$  at 1.0 GHz
- Unconditionally Stable ( $k > 1$ )
- Surface Mount Plastic Package
- Tape-and-Reel Packaging Option Available

#### 86 Plastic Package

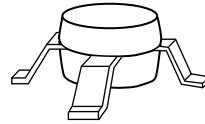

#### Typical Biasing Configuration

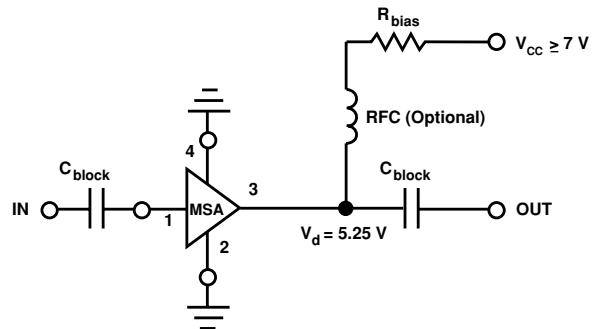

### MSA-0486 Absolute Maximum Ratings

Parameter	Absolute Maximum <sup>[1]</sup>
Device Current	85 mA
Power Dissipation <sup>[2,3]</sup>	500 mW
RF Input Power	+13 dBm
Junction Temperature	150°C
Storage Temperature	-65 to 150°C

#### Thermal Resistance<sup>[2,4]</sup>:

$$\theta_{jc} = 100^{\circ}\text{C}/\text{W}$$

#### Notes:

1. Permanent damage may occur if any of these limits are exceeded.
2.  $T_{\text{CASE}} = 25^{\circ}\text{C}$ .
3. Derate at 10 mW/°C for  $T_{\text{C}} > 100^{\circ}\text{C}$ .

### Electrical Specifications<sup>[1]</sup>, $T_{\text{A}} = 25^{\circ}\text{C}$

Symbol	Parameters and Test Conditions: $I_{\text{d}} = 50 \text{ mA}$ , $Z_{\text{o}} = 50 \Omega$	Units	Min.	Typ.	Max.
$G_{\text{P}}$	Power Gain ( $ S_{21} ^2$ ) f = 0.1 GHz f = 1.0 GHz	dB	7.0	8.3 8.0	
$\Delta G_{\text{P}}$	Gain Flatness f = 0.1 to 2.0 GHz	dB		$\pm 0.6$	
$f_{3 \text{ dB}}$	3 dB Bandwidth	GHz		3.2	
VSWR	Input VSWR f = 0.1 to 3.0 GHz			1.5:1	
	Output VSWR f = 0.1 to 3.0 GHz			1.9:1	
NF	50 $\Omega$ Noise Figure f = 1.0 GHz	dB		7.0	
$P_{1 \text{ dB}}$	Output Power at 1 dB Gain Compression f = 1.0 GHz	dBm		12.5	
$\text{IP}_3$	Third Order Intercept Point f = 1.0 GHz	dBm		25.5	
$t_{\text{D}}$	Group Delay f = 1.0 GHz	psec		140	
$V_{\text{d}}$	Device Voltage	V	4.2	5.25	6.3
$\text{dV}/\text{dT}$	Device Voltage Temperature Coefficient	mV/°C		-8.0	

#### Note:

1. The recommended operating current range for this device is 30 to 70 mA. Typical performance as a function of current is on the following page.

### Ordering Information

Part Numbers	No. of Devices	Comments
MSA-0486-BLK	100	Bulk
MSA-0486-BLKG	100	Bulk
MSA-0486-TR1	1000	7" Reel
MSA-0486-TR1G	1000	7" Reel
MSA-0486-TR2	4000	13" Reel
MSA-0486-TR2G	4000	13" Reel

**Note:** Order part number with a "G" suffix if lead-free option is desired.

**MSA-0486 Typical Scattering Parameters ( $Z_0 = 50 \Omega$ ,  $T_A = 25^\circ\text{C}$ ,  $I_d = 50 \text{ mA}$ )**

Freq. GHz	$S_{11}$		$S_{21}$			$S_{12}$			$S_{22}$	
	Mag	Ang	dB	Mag	Ang	dB	Mag	Ang	Mag	Ang
0.1	.14	178	8.4	2.62	175	-16.2	.154	1	.16	-10
0.2	.14	175	8.3	2.61	170	-16.3	.153	2	.16	-20
0.4	.14	171	8.2	2.57	161	-16.3	.154	3	.17	-39
0.6	.13	168	8.1	2.54	151	-16.0	.158	4	.18	-57
0.8	.13	166	8.0	2.52	141	-15.9	.161	5	.20	-74
1.0	.13	165	7.9	2.48	131	-15.7	.165	6	.21	-88
1.5	.15	168	7.7	2.42	108	-14.8	.182	8	.27	-121
2.0	.21	168	7.3	2.32	84	-14.0	.199	7	.32	-149
2.5	.29	165	6.8	2.18	65	-13.1	.222	4	.38	-168
3.0	.37	153	5.9	1.97	43	-12.7	.231	-1	.40	173
3.5	.44	142	4.8	1.74	24	-12.5	.238	-5	.41	157
4.0	.50	130	3.6	1.52	7	-12.5	.238	-10	.41	145
5.0	.61	109	1.3	1.16	-21	-12.7	.231	-17	.43	132

**Typical Performance,  $T_A = 25^\circ\text{C}$** 

(unless otherwise noted)

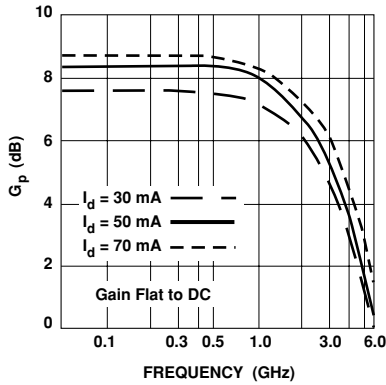
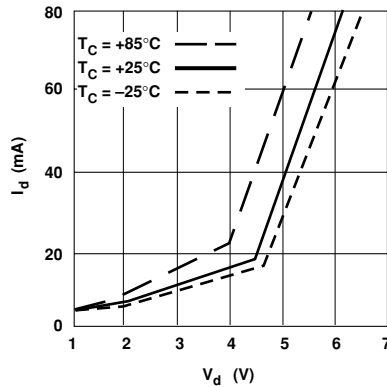
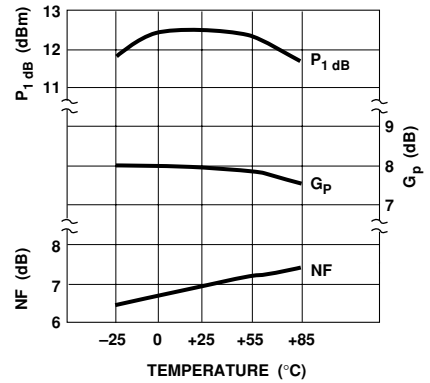
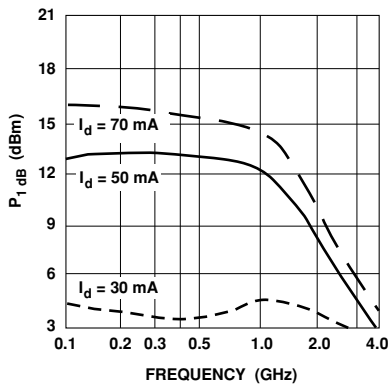
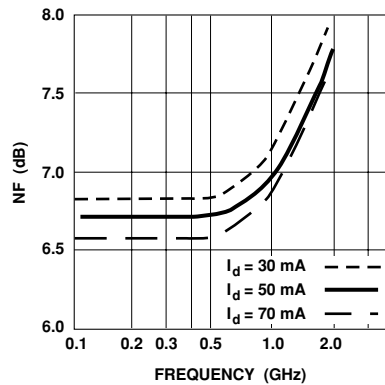
**Figure 1. Typical Power Gain vs. Frequency,  $T_A = 25^\circ\text{C}$ .**

**Figure 2. Device Current vs. Voltage.**

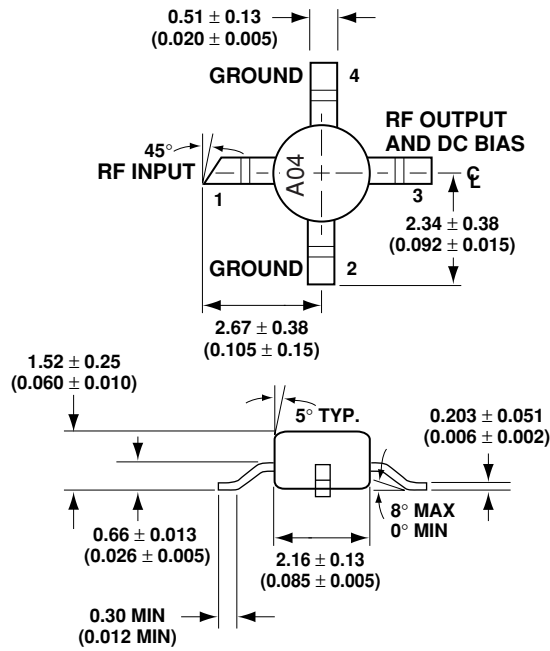
**Figure 3. Output Power at 1 dB Gain Compression, NF and Power Gain vs. Case Temperature,  $f = 1.0 \text{ GHz}$ ,  $I_d = 50 \text{ mA}$ .**

**Figure 4. Output Power at 1 dB Gain Compression vs. Frequency.**

**Figure 5. Noise Figure vs. Frequency.**

## 86 Plastic Package Dimensions



DIMENSIONS ARE IN MILLIMETERS (INCHES)

For product information and a complete list of distributors, please go to our web site:  
[www.avagotech.com](http://www.avagotech.com)

Avago, Avago Technologies, and the A logo are trademarks of Avago Technologies, Limited in the United States and other countries.  
 Data subject to change. Copyright © 2006 Avago Technologies, Limited. All rights reserved.  
 Obsoletes 5989-2084EN  
 5989-2753EN August 22, 2006

**AVAGO**  
 TECHNOLOGIES