

2N3866
2N3866A

The RF Line

NPN SILICON HIGH FREQUENCY TRANSISTOR

... designed for amplifier and oscillator applications in military and industrial equipment. Suitable for use as output, driver or pre-driver stages in VHF and UHF equipment.

- Specified 400 MHz, 28 Vdc Characteristics –
 Output Power = 1.0 Watt
 Minimum Gain = 10 dB
 Efficiency = 45%
- Large Signal Series Equivalent Impedances
- S-Parameter Characterization

1.0 W – 400 MHz
HIGH FREQUENCY
TRANSISTOR
 NPN SILICON

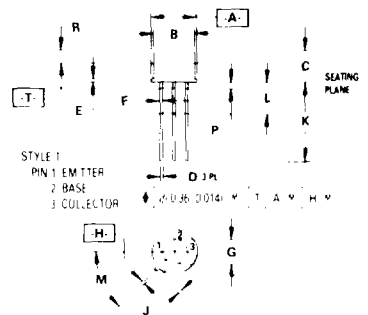
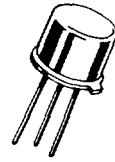

STYLE 1
 PIN 1 EMITTER
 2 BASE
 3 COLLECTOR

NOTES

1. DIMENSIONING AND TOLERANCING PER ANS Y14.5M 1982
2. CONTROLLING DIMENSION INCH
3. DIMENSION J MEASURED FROM DIMENSION A MAXIMUM
4. DIMENSION B SHALL NOT VARY MORE THAN 0.25 (0.370) IN ZONE R. THIS ZONE CONTROLLED FOR AUTOMATIC HANDLING
5. DIMENSION F APPLIES BETWEEN DIMENSION P AND L. DIMENSION D APPLIES BETWEEN DIMENSION L AND K. MINIMUM LEAD DIAMETER S UNCONTROLLED IN DIMENSION P AND BEYOND DIMENSION K. MINIMUM

DIM	MILLIMETERS		INCHES	
	MIN	MAX	MIN	MAX
A	8.51	9.39	0.335	0.370
B	1.75	6.50	0.305	0.375
C	6.10	6.50	0.240	0.260
D	3.41	3.53	0.136	0.121
E	0.23	1.04	0.009	0.041
F	0.41	0.48	0.016	0.019
G	5.08 BSC 0.200 BSC			
H	0.72	1.86	0.028	0.074
J	0.74	1.14	0.029	0.045
K	12.70	19.05	0.500	0.750
L	6.35		0.250	
M	45 BSL 45 BSC			
P	1.27		0.050	
R	2.54		0.100	

CASE 79-04
TO-205AD
(TO-39)

***MAXIMUM RATINGS**

Rating	Symbol	Value	Unit
Collector-Emitter Voltage	V_{CEO}	30	Vdc
Collector-Base Voltage	V_{CBO}	55	Vdc
Emitter-Base Voltage	V_{EBO}	3.5	Vdc
Collector Current - Continuous	I_C	0.4	A dc
Total Device Dissipation @ $T_C = 25^\circ\text{C}$ Derate Above 25°C	P_D	5.0 28.6	Watts mW/ $^\circ\text{C}$
Storage Temperature Range	T_{stg}	-65 to +200	$^\circ\text{C}$

*Indicates JEDEC Registered Data

2N3866, 2N3866A

*ELECTRICAL CHARACTERISTICS ($T_C = 25^\circ\text{C}$ unless otherwise noted).

Characteristic	Symbol	Min	Max	Unit
OFF CHARACTERISTICS				
Collector-Emitter Sustaining Voltage ($I_C = 5.0 \text{ mAdc}$, $I_B = 0$)	$V_{CE(sus)}$	30	—	Vdc
Collector-Base Sustaining Voltage ($I_C = 5.0 \text{ mAdc}$, $R_{BE} = 10 \Omega$)	$V_{CER(sus)}$	55	—	Vdc
Emitter-Base Breakdown Voltage ($I_E = 100 \mu\text{Adc}$, $I_C = 0$)	$V_{(BR)EBO}$	3.5	—	Vdc
Collector Cutoff Current ($V_{CE} = 28 \text{ Vdc}$, $I_B = 0$)	I_{CEO}	—	0.02	mAdc
Emitter Cutoff Current ($V_{BE} = 3.5 \text{ Vdc}$, $I_C = 0$)	I_{EBO}	—	0.1	mAdc
Collector Cutoff Current ($V_{CE} = 30 \text{ Vdc}$, $V_{BE} = -1.5 \text{ Vdc (Rev.)}$, $T_C = 200^\circ\text{C}$) ($V_{CE} = 55 \text{ Vdc}$, $V_{BE} = -1.5 \text{ Vdc (Rev.)}$)	I_{CEX}	—	5.0 0.1	mAdc
ON CHARACTERISTICS				
DC Current Gain ($I_C = 360 \text{ mAdc}$, $V_{CE} = 5.0 \text{ Vdc}$) ($I_C = 50 \text{ mAdc}$, $V_{CE} = 5.0 \text{ Vdc}$)	Both 2N3866 2N3866A	5.0 10 25	— 200 200	—
Collector-Emitter Saturation Voltage ($I_C = 100 \text{ mAdc}$, $I_B = 20 \text{ mAdc}$)	$V_{CE(sat)}$	—	1.0	Vdc
DYNAMIC CHARACTERISTICS				
Current-Gain — Bandwidth Product ($I_C = 50 \text{ mAdc}$, $V_{CE} = 15 \text{ Vdc}$, $f = 200 \text{ MHz}$)	2N3866 2N3866A	500 800	— —	MHz
Output Capacitance ($V_{CB} = 28 \text{ Vdc}$, $I_E = 0$, $f = 1.0 \text{ MHz}$)	C_{ob}	—	3.0	pF
FUNCTIONAL TESTS				
Common-Emitter Amplifier Power Gain ($V_{CC} = 28 \text{ Vdc}$, $P_{out} = 1.0 \text{ W}$, $f = 400 \text{ MHz}$)	G_{pE}	10	—	dB
Collector Efficiency ($V_{CC} = 28 \text{ Vdc}$, $P_{out} = 1.0 \text{ W}$, $f = 400 \text{ MHz}$)	η	45	—	%

*Indicates JEDEC Registered Data.

FIGURE 1 — 400 MHz TEST CIRCUIT SCHEMATIC

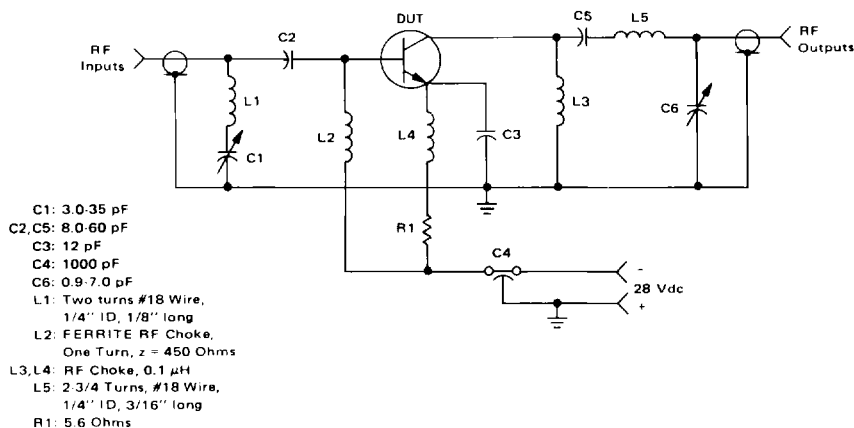

2N3866, 2N3866A

2

FIGURE 2 - POWER OUTPUT versus FREQUENCY (Class C)

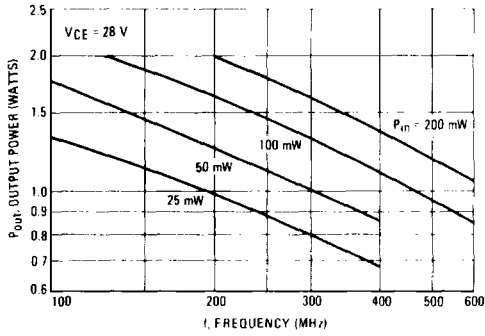

FIGURE 3 - CURRENT GAIN - BANDWIDTH PRODUCT

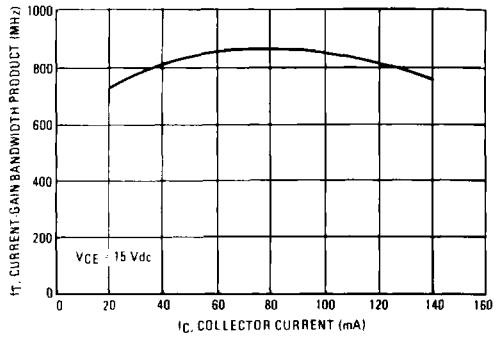

FIGURE 4 - COLLECTOR-BASE TIME CONSTANT

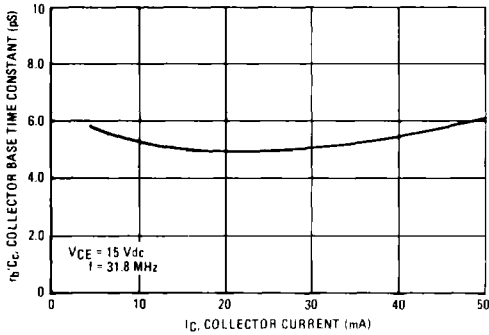

FIGURE 5 - OUTPUT CAPACITANCE

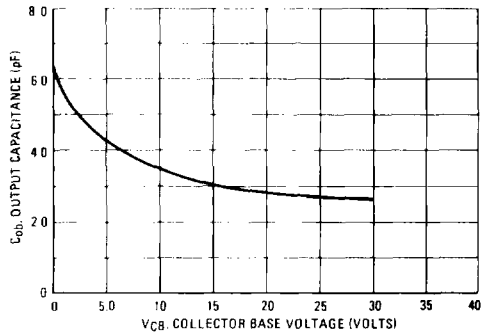

FIGURE 6 - OUTPUT POWER versus INPUT POWER (CLASS C)

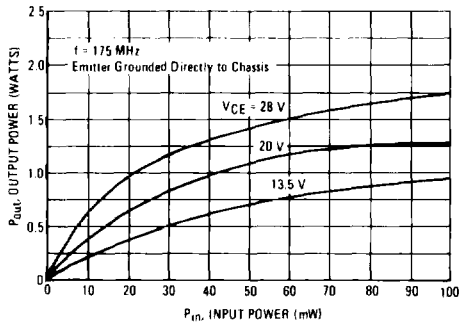
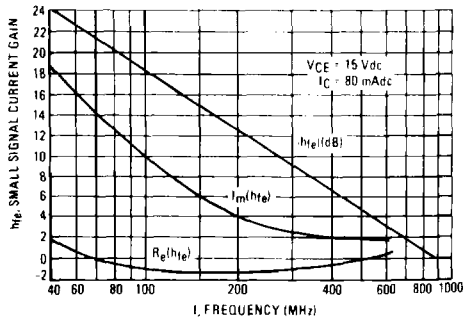

FIGURE 7 - SMALL SIGNAL CURRENT GAIN



2N3866, 2N3866A

FIGURE 8 – LARGE-SIGNAL SERIES EQUIVALENT IMPEDANCES

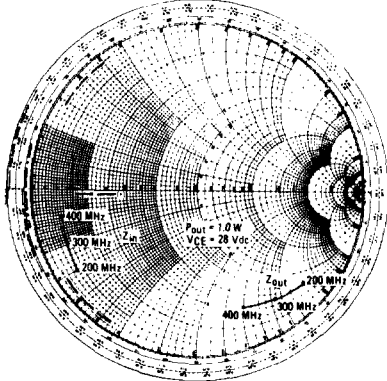

FIGURE 10 – S_{21} versus FREQUENCY

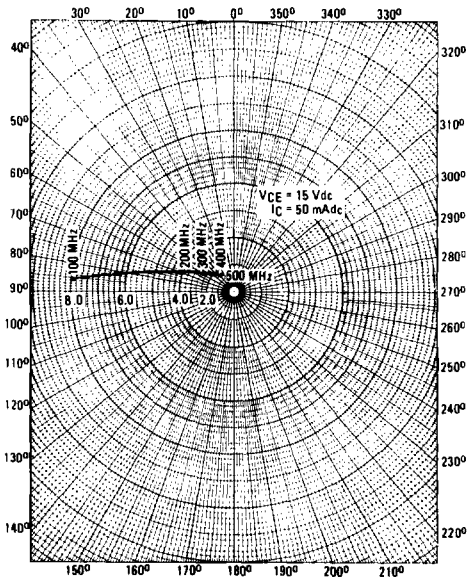

FIGURE 9 – S_{11} AND S_{22} versus FREQUENCY

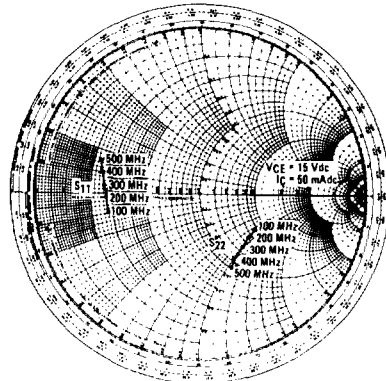

FIGURE 11 – S_{12} versus FREQUENCY

