



ENIGMA BROADCAST 2m 300W AMPLIFIER KIT v2

Thank you for purchasing the Enigma Broadcast 2m 300W v2 amplifier kit. Please read these instructions carefully before assembly to prevent mistakes and ensure optimum performance.

Tools & Parts Required

- ✓ Sharp, flush-cut mini side cutters
- ✓ Long-nose & regular pliers
- ✓ PZ1 Pozidrive screwdriver
- ✓ Electric drill
- ✓ 2.5mm, 3.0mm, 6.5mm & 7.5mm HSS drill bits
- ✓ 40-60W soldering iron & solder
- ✓ Sandpaper or small flat file
- ✓ Silicone heatsink compound
- ✓ Ruler
- ✓ Isopropanol alcohol/ acetone and cotton buds (cotton sticks)
- ✓ Heatsink (at least 1.2°/ W dissipation. Enigma HS150 or HS200 are recommended)

Assembly Instructions

1. Using sandpaper or a small file, smooth the long edges of the amplifier PCB where it has been removed from its panel after automatic SMT assembly.
2. Lay the PCB on top of the heatsink and place the MRFE6VP6300H power transistor into its cut-out in the centre of the board. Using a fin-tip marker or scribe, mark the 5 holes in the PCB and a further two holes for mounting the transistor. See figure 1.

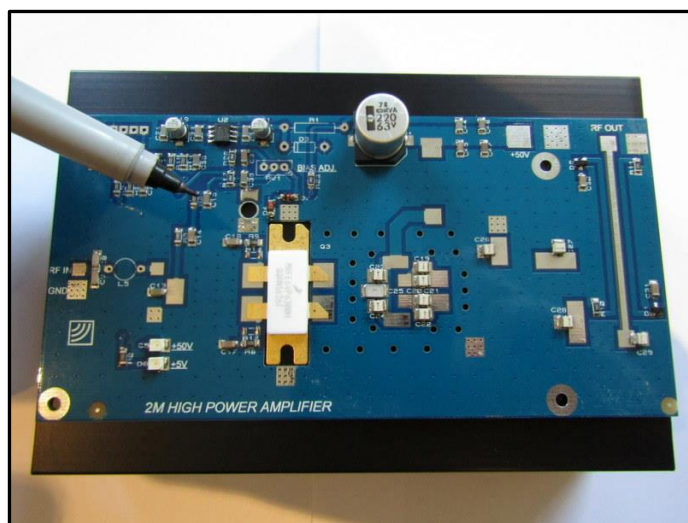

Figure 1: Marking the heatsink for drilling.

3. Drill 4 x 2.5mm holes for mounting the PCB (one near each corner) and a further two 2.5mm holes for the RF transistor. The other hole nearest the transistor is for mounting a thermistor and this should be drilled using a 3.0mm drill. We recommend drilling all holes to a depth of at least 9mm to prevent bottoming of the screws.
4. Using a larger drill bit, gently remove any burrs from the top of the 7 freshly-drilled holes to achieve a flat heatsink surface. Using a drill bit held between the fingers is usually sufficient.
5. Set aside the heatsink and solder the following 5 components to the PCB. Although these are leaded components they are all soldered to the top surface of the board as if surface-mount. Bend and trim the legs as necessary to align with the various pads on the board.
 - L5 - 3.5t orange mini S18 moulded coil
 - RV1 – 10K multi-turn preset (note orientation)
 - D3 – 12V 1W zener diode (note orientation)
 - J1 – 4-way XH socket
 - J2 – 3-way XH socket

Please see figure 2a for orientation and placement of D3 and RV1, and figure 2b for position of L5.

D3 is mounted with the black stripe to the right and RV1 is mounted with the brass screw to the right. The legs of J1 and J2 should be trimmed so that the connectors lay flat to the board.

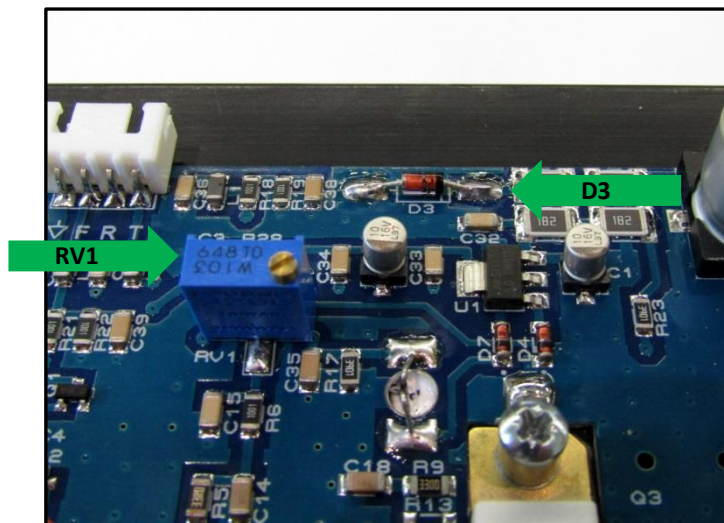

Figure 2a: D3 and RV1 position.

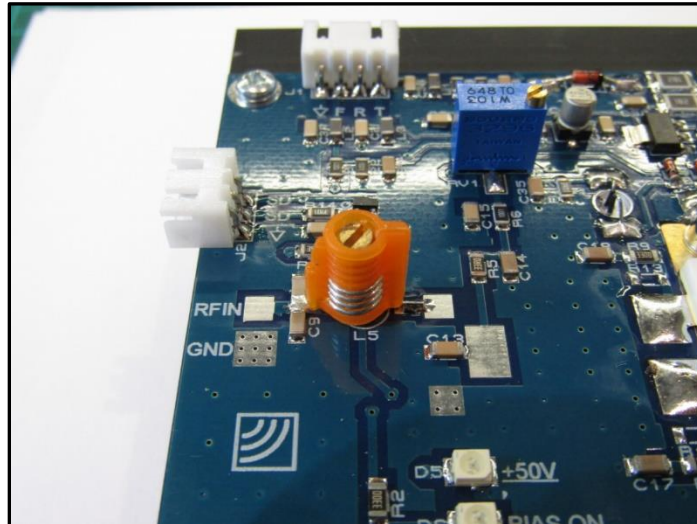
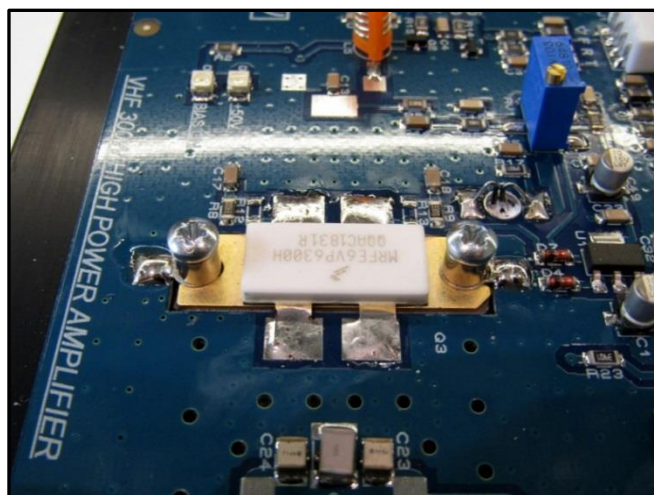

Figure 2b: Location of L5.

6. Squeeze some silicone heatsink compound into the 3mm thermistor hole near the transistor mounting holes on the heatsink (fill it as much as possible). Wipe the top surface to clear any overspill away.

Using 4 x 9mm No.4 self-tapping screws, mount the PCB flat to the heatsink. Don't overtighten the mounting screws or the PCB may warp.

7. Smear a small amount of heatsink compound on the flange of the RF power transistor and using the 13mm No.4 self-tapping screws, two M3 earth tags and PCB spacers, mount the RF transistor to the heatsink (drain corner-cropped leads to the right). Position the earth tags as shown in figure 3, so they can be soldered to the ground pads near the top and bottom of the transistor. The tags should be trimmed so that they cover the ground pads and don't overhang blue areas of the board or touch other components.



*Figure 3:
Transistor
mounting and
earth tag
placement*

ENIGMA BROADCAST 2m 300W AMPLIFIER KIT v2

8. Cut the thermistor leads to 15mm length and carefully bend them in to a U shape as shown in figure 4a. Place the thermistor in to the hole filled with heatsink compound and then solder the leads onto the pads as in figure 4b, taking care the leads do not touch each other.

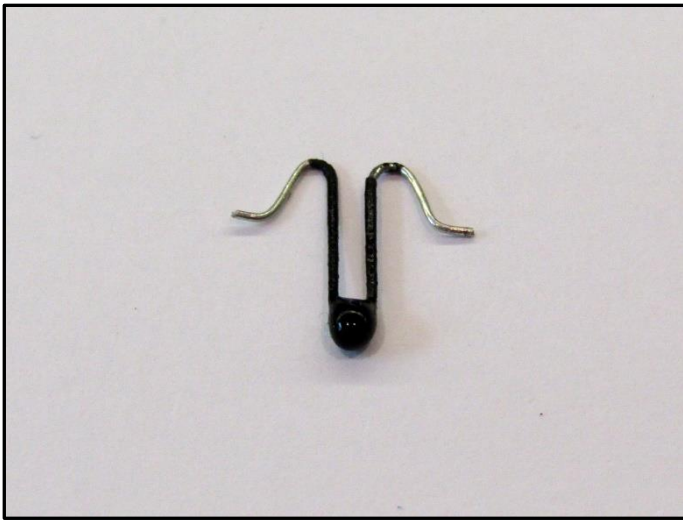

Figure 4a: Thermistor leg shape.

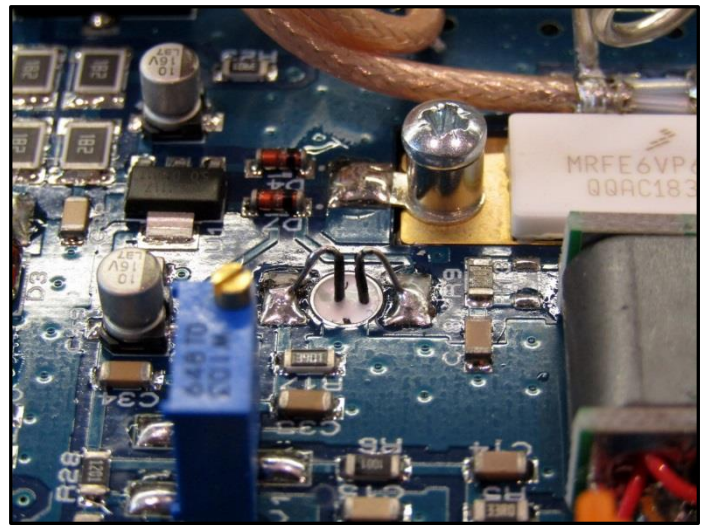

Figure 4b: Thermistor placement.

9. Solder the RF power mosfet MRFE6VP6300H transistor legs to their pads on the PCB using a small amount of solder.
10. Make the input transformer as shown in figures 5a – 5d. The easiest way is to assemble the transformer vertically on the workbench and solder in the tubes from each end. You can hold the assembly steady with one finger while soldering each tube in turn. Take care to ensure the assembly is straight and can be mounted flat to the board once finished.



ENIGMA BROADCAST
2m 300W AMPLIFIER KIT
v2

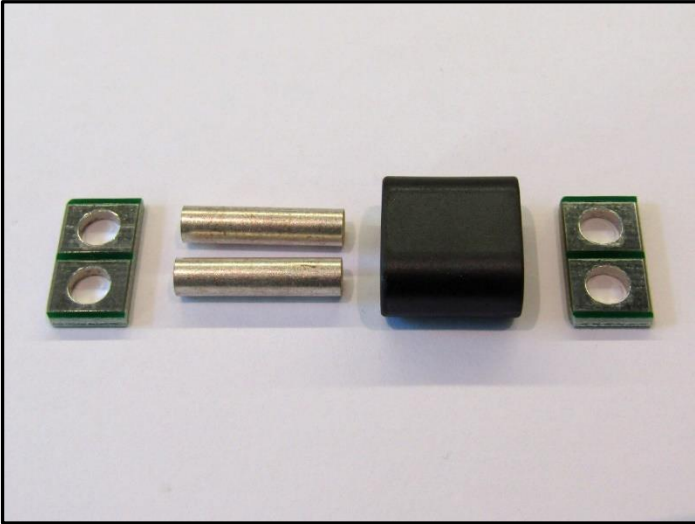

Figure 5a: Transformer parts

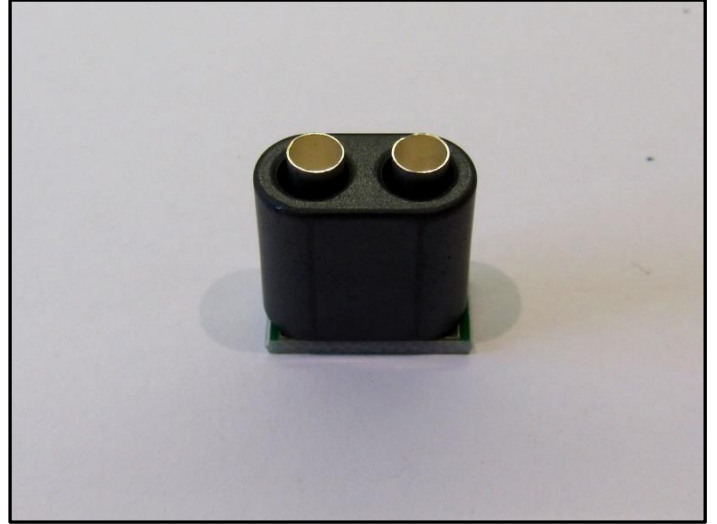

Figure 5b: Parts placement

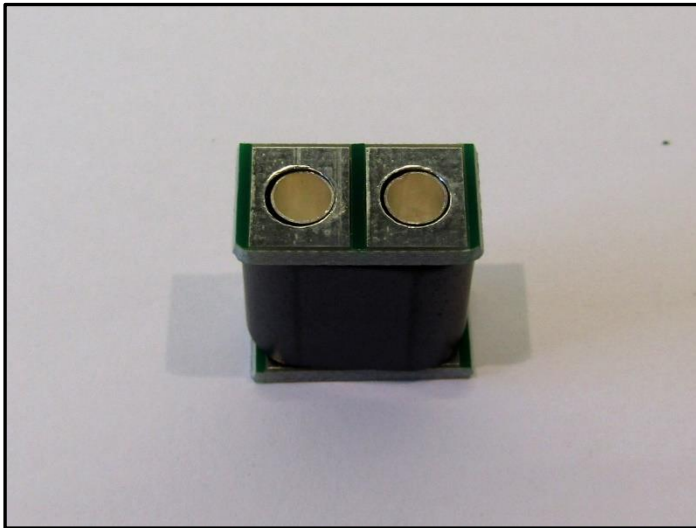

Figure 5c: Transformer before soldering

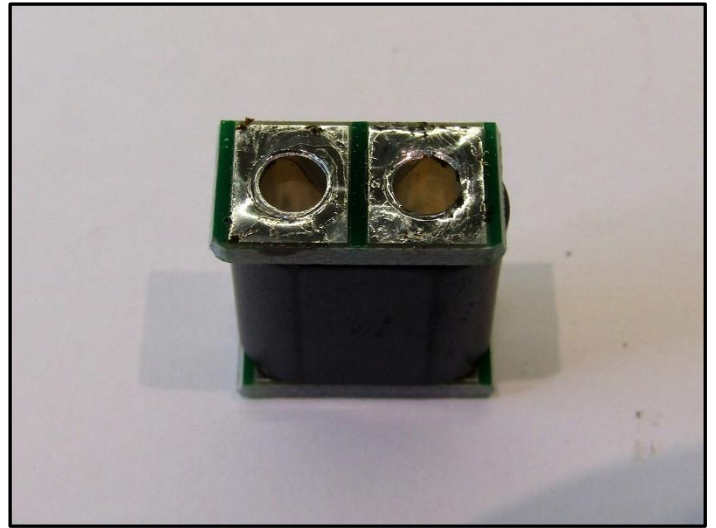

Figure 5d: Fully assembled transformer

ENIGMA BROADCAST 2m 300W AMPLIFIER KIT v2

Solder the binocular RF transformer to the pads on the left (the gates) of the RF transistor. The pads at the opposite end of the transformer (near C13) share a single PCB pad underneath and should both be soldered down to it. This creates a 1-turn secondary winding which is made up of the nickel-plated tubes feeding the input of the transistor and forming a centre-tap for insertion of DC bias for the mosfet at C13.

Strip a few millimetres of insulation from the red-coloured 104mm PTFE wire and thread two turns into the tubes in the transformer. Solder the ends of the PTFE wire to the pads above and below C13. See figures 6a – 6d for details.

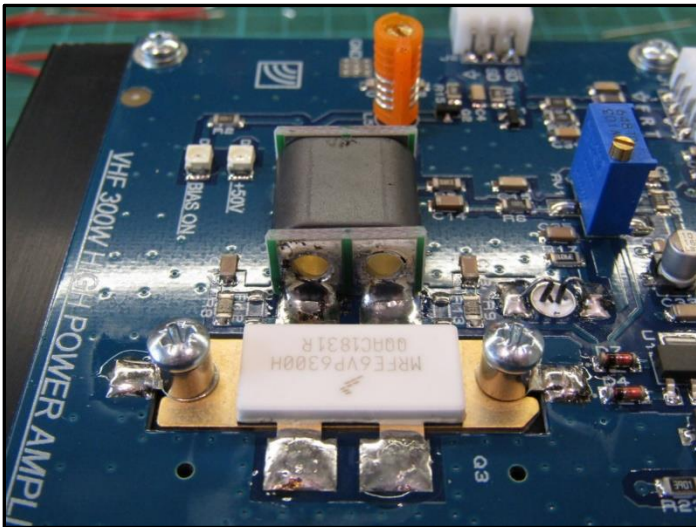

Figure 6a: Transformer soldered to mosfet gates

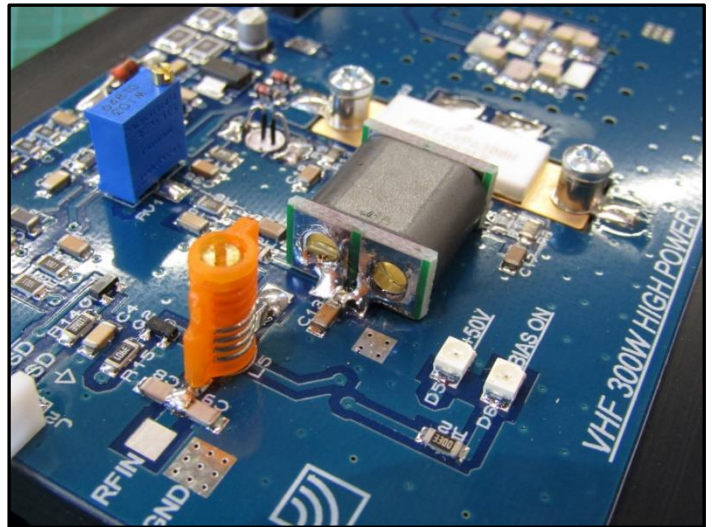

Figure 6b: Transformer left side.

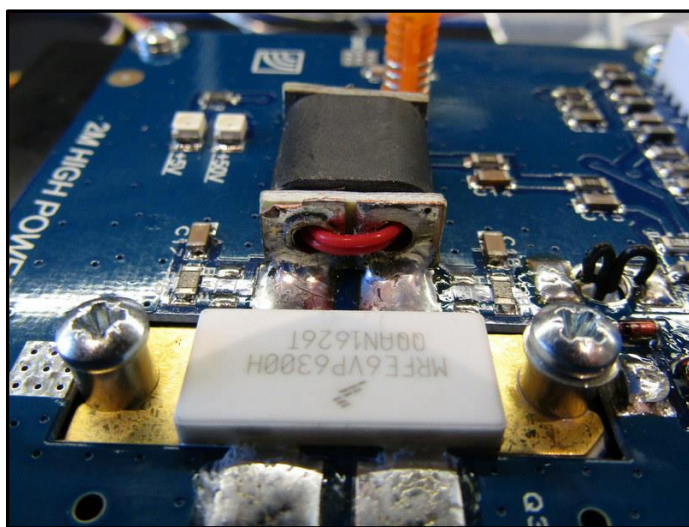

Figure 6c: Transformer winding detail.

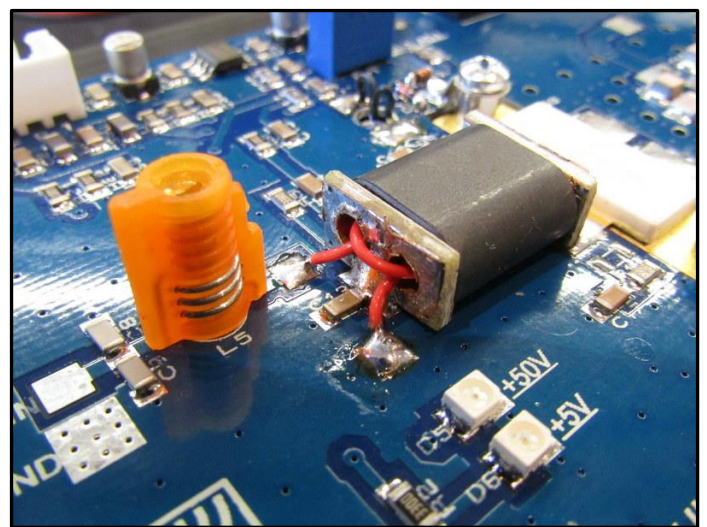

Figure 6d: Transformer winding detail.

11. Identify the two 140mm sections of 25Ω coaxial cable (slightly stiffer of the two coax types). Strip 8mm of the insulation from one end of each piece and 5mm from the other. Fold back the earth braid on all ends and tin the braid with a soldering iron. Strip the inner cores by about 2mm and solder the 8mm stripped coax ends to the output pads of the transistor so that they cross over as in figure 7.

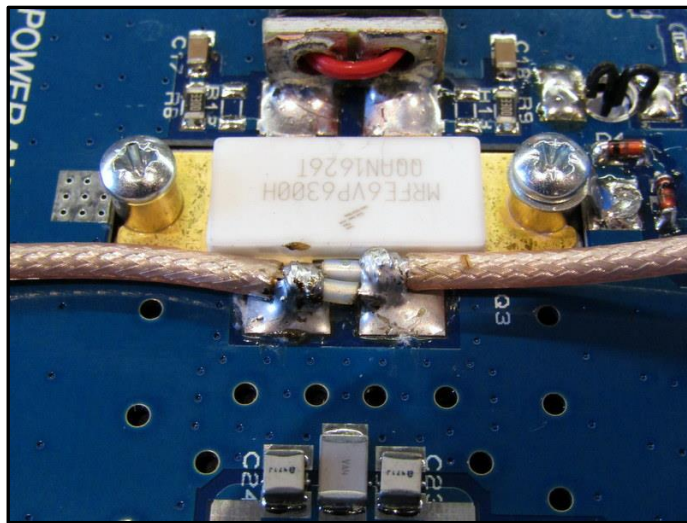

Figure 6: Transistor output coaxes.

12. Cut a 63mm length of the 16SWG tinned copper wire and wind around a 7.5mm drill bit to form a 1.5 turn coil with 5mm leads, as in figure 8. Solder this coil across the transistor output pads as in figure 9. Take care the windings of the coil don't touch the coax outer braids. This is L4, the drain coil of the amplifier.



Figure 7: L4 Winding detail.

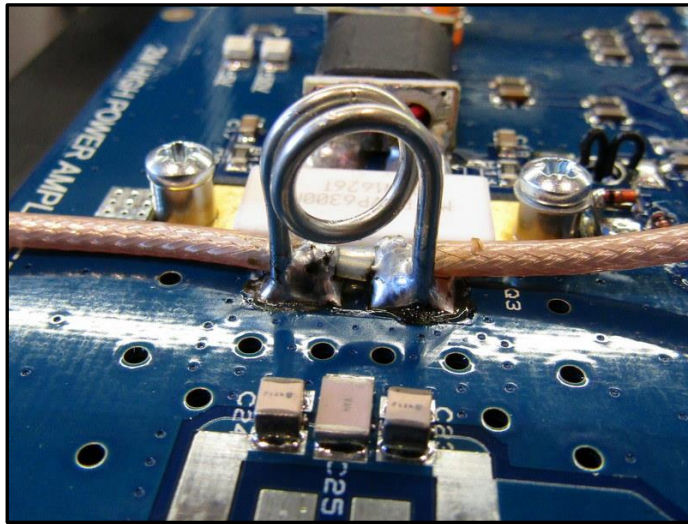

Figure 9: L4 mounting.

13. Form two opposing coils with the coax and solder to pads near C19, 20, 21 & C22 as shown in figure 10. Secure the coils with two cable ties and lift the coils slightly away from the PCB.

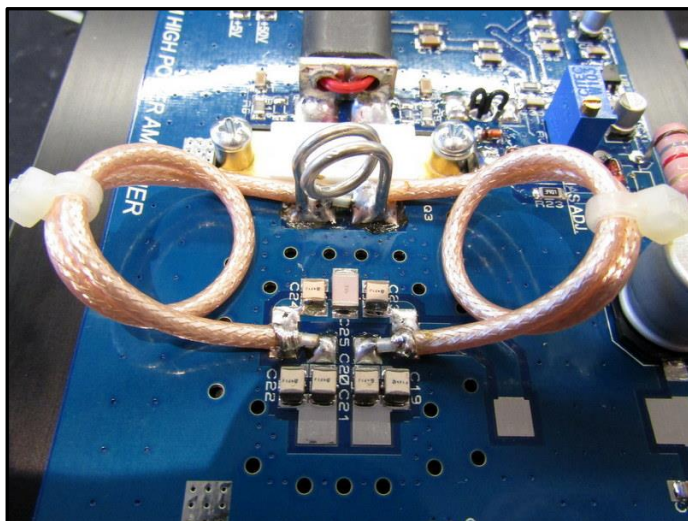

Figure 8: Transistor coax position.

14. Cut a 200mm piece of 16SWG tinned copper wire and form a 7 turn coil around a 6.5mm drill bit. The length of this coil should be 18mm from centre-to-centre of the wire as shown in figure 11. Bend and trim the excess wire to form 2mm leads. Solder the coil in position as in figure 12. This is L7, the DC drain feed coil for the RF power transistor.

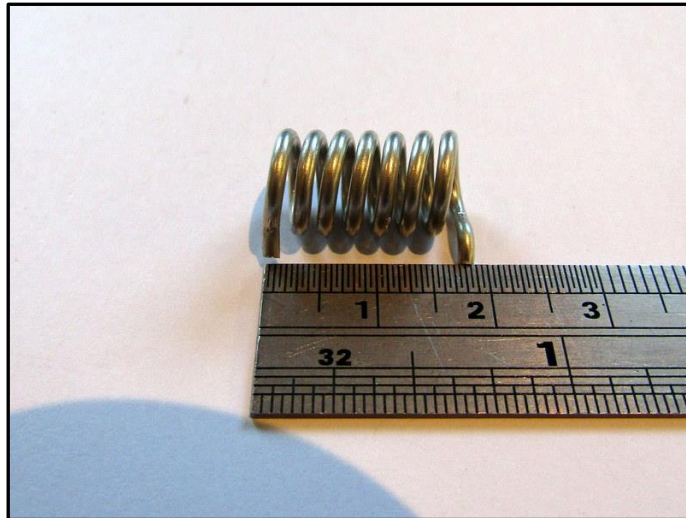

Figure 9: L7 Winding detail.

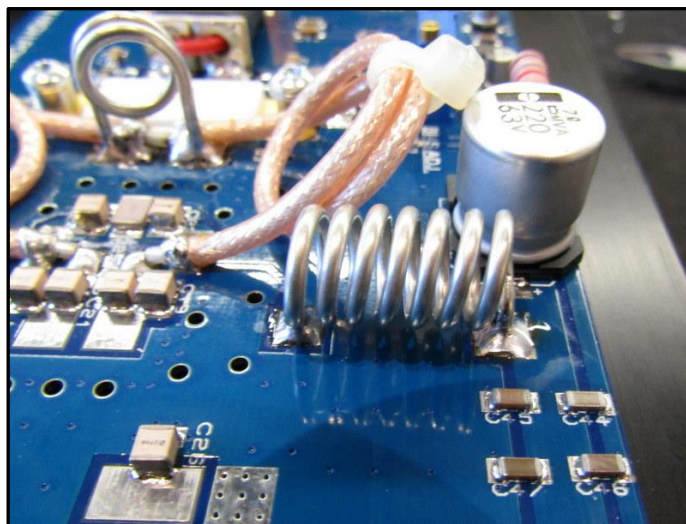

Figure 10: L7 Position.

15. Identify the two remaining 150mm sections of RG316 50Ω coaxial cable. Strip 6mm of the insulation from each end and prepare one piece of coax for mounting to the PCB (fold back and solder earth braid and strip the centre conductor). Solder to the PCB to form the output balun Z4 as in figure 13. One end of the coax is connected to the right of C20 & C21, the other to ground & C26.

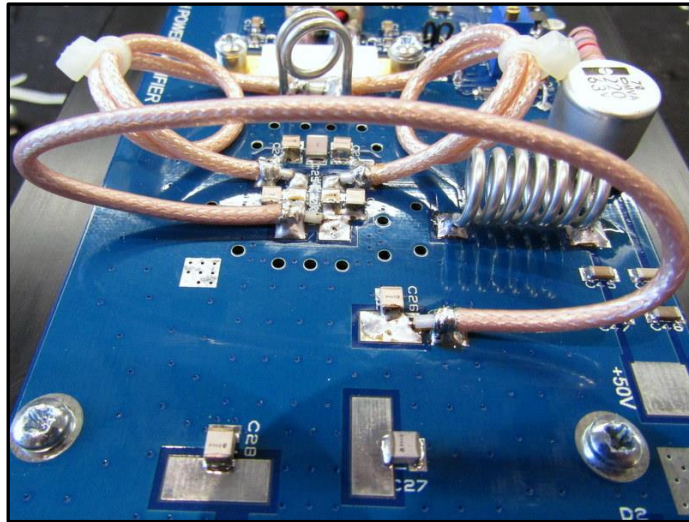

Figure 11: Z4 Position.

16. Fold back the earth braid on the second piece of RG316 and solder but do not strip and prepare the centre conductors. Solder one end of the coax at the pad nearest C21 (this is also the centre conductor of the coax mounted in step 14). Solder the other end to the isolated ground pad below and to the right of C22. When this step is finished you should only have coax earth braid connected between C21 and ground, forming Z5. See figure 14. Cable-tie and secure the two coax sections together.

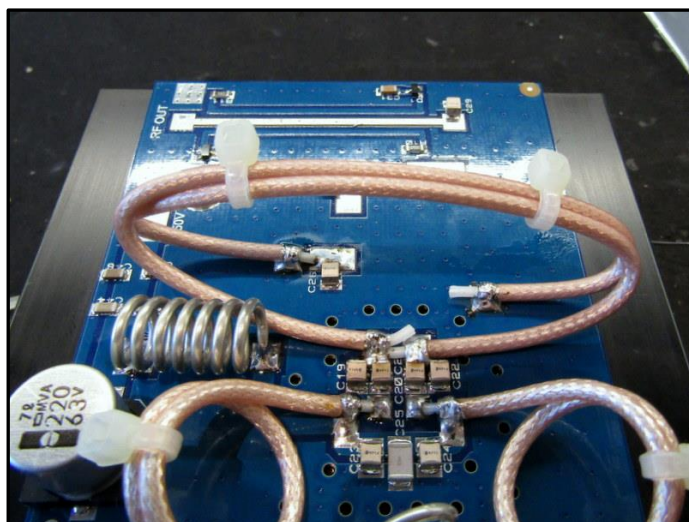

Figure 12: Z4 and Z5 Position

17. Cut two 122mm pieces of 16SWG tinned copper wire and make two 4-turn close-wound coils around a 6.5mm drill bit. The length of both coils should be 9mm from centre-to-centre of the wire. Bend and trim the excess wire to form 2mm leads and solder the first coil in position at the pads near C26 & C27. This is L8, the first coil of the low pass filter. See figure 15.

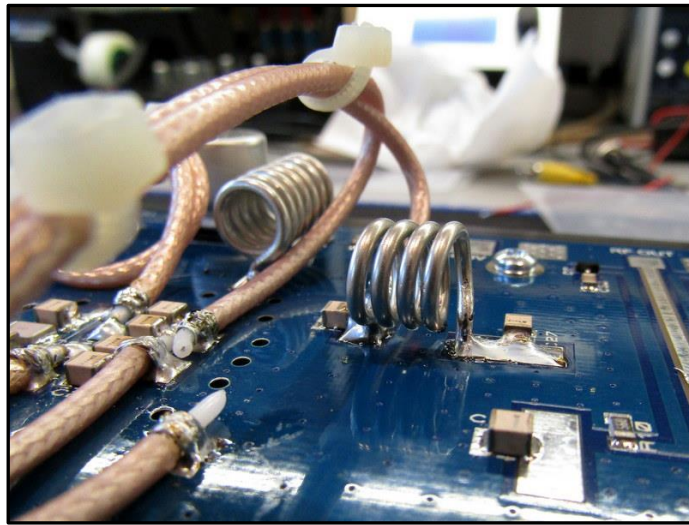

Figure 13: L8 Position.

18. Cut one 135mm length of 16SWG tinned copper wire and form a 4 turn close-wound coil around a 7.5mm drill bit. The length of this coil should be 10mm from centre-to-centre. Bend and trim the excess wire to form 2mm leads and solder in position at 90 degrees to L8, between the pads at C27 & C28. This coil forms L9, the second coil in the low pass filter. See figure 16.

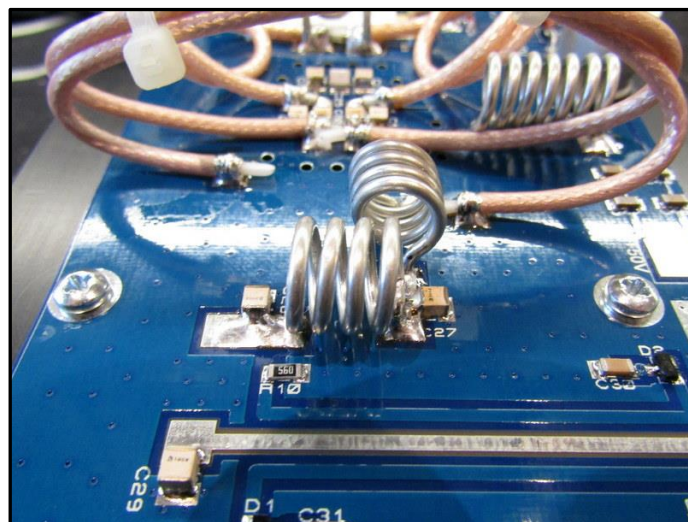

Figure 14: L9 Position.

19. Solder the remaining coil (made in step 16.) to the pads at C28 & C29, 90 degrees to L9. This is L10, the final coil of the low pass filter. See figure 17.

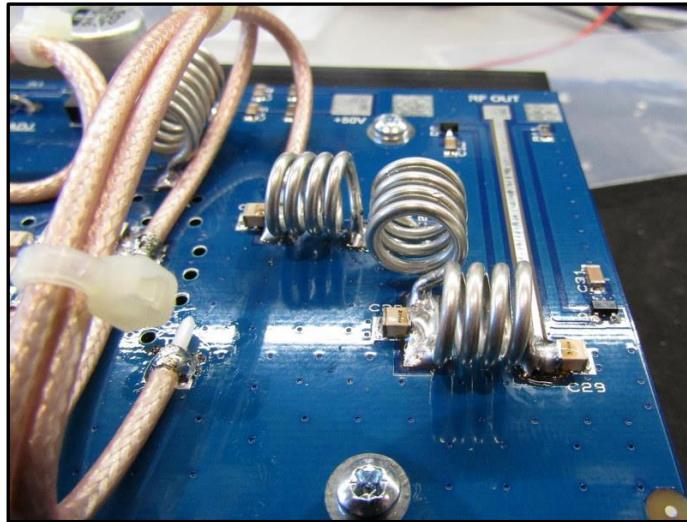

Figure 15: L10 Position.

20. Using some isopropanol alcohol/ acetone and cotton buds, clean around the PCB pads at the output of the amplifier to remove any solder flux which may be present after soldering the output coaxes and low pass filter coils. If a solder with rosin-based flux has been used the flux may have dried hard and can be scraped away with a small flat screwdriver before cleaning. Pay particular attention to the pads forming the low pass filter. Due to the high RF power present at these points, flux may degrade over time, become slightly conductive and cause arcing which will lead to destruction of the the pad where the arcing occurred.
21. Assembly of the amplifier module is now complete! Please take some time to run through these steps again, double checking your work and looking for short circuits or dry joints. If all is well, proceed to the next step.

Set-up & Testing of the Amplifier

You will need:

- ✓ 2W CW/ FM drive signal from 140-150MHz
- ✓ 48V/ 500W, variable power supply (preferably current-limited)
- ✓ Voltmeter
- ✓ Ammeter
- ✓ Dummy load or antenna
- ✓ Cooling fan (at least 50cfm) 92mm type is recommended.



ENIGMA BROADCAST 2m 300W AMPLIFIER KIT v2

1. Turn the brass screw of RV1 anticlockwise about 10 full turns. You may hear it faintly click at the end of its travel. This is the bias control for the RF power transistor and needs to be set to minimum before powering up.
2. Connect the power supply to the DC power pads near the top right of the board and set to a 50mA current limit.
3. Connect input and output coax cables to the drive source and dummy load. These are clearly marked RF IN and RF OUT at the left and right of the board.
4. Slowly increase voltage to the module and note the current draw. It should reach a maximum about 30mA. Stop at 48V. If the current exceeds 50mA there may be a fault, the bias preset incorrectly orientated, or not turned fully to minimum.
5. Check voltages between ground (a screw head) and the following points
 - About 12-12.5V at the right-hand pad of D3
 - 5.6V at the top of C33 (near U1 regulator)
 - About 0.6V at the top of C15 (preset wiper)
6. Increase the current limit on the power supply to 100mA. Turn the bias control on RV1 clockwise until the current rises to about 80mA (about 50mA bias of the transistor). Note the bias voltage present at the top of C15 will have increased to about 2.4V.
7. Using a trimming tool, adjust L5 so that the brass core is turned clockwise about 1.5 turns from being level with the top of the orange former.
8. Place a cooling fan at the right of the module so that it blows air across the heatsink fins and also the top of the board from right to left. The output coax and low pass filter sections will get hot during use and they need cooling airflow to prevent overheating.
9. Apply RF drive (about 2W) at 145MHz and slowly increase the current limit on the power supply. You should see output power increase with voltage and the module should easily exceed 300W at 48V and 2W input drive. Verify output power remains fairly constant between 144-146MHz (and 140-150MHz, if desired).

The amplifier module is now ready for FM use.



ENIGMA BROADCAST 2m 300W AMPLIFIER KIT v2

To further enhance the performance of the module you may connect a SWR meter between the input of the amplifier and the driving radio. Adjust L5 for lowest SWR at the band centre (145MHz) and check it is equal at the band edges.

You can also optimise the drain efficiency & power output of the amplifier by slightly spreading or closing the coils at L4, L8, L9 & L10.

We have found for best performance that L9 should have its turns slightly open when compared to L8 and L10, however if the coils have been correctly wound as detailed in steps 17 & 18 they should need little to no adjustment.

We don't recommend making large adjustments to the low pass filter coils as this may degrade the harmonic suppression of the filter.

For linear operation, the bias to the power mosfet will need to be increased. During development, the amplifier design was optimised for gain and efficiency using a CW signal with an output of about 330-350W. For linear operation we recommend increasing the bias to the region of 500-800mA and adjust for best performance thereafter. During development the module was tested and a bias level of 650mA was found to be suitable for good IMD performance at 250W PEP output power. Note that the voltage regulator circuit and LEDs draw around 30mA by themselves, so any bias current should be added to this value. For example, setting a bias current of 650mA for the transistor will show an overall current of 680mA when making adjustments to the complete module.

Bias Shutdown Facility

During linear operation the amplifier requires bias current which can waste power and generate unwanted heat when the unit is idling. We have provided a dual-mode bias shutdown facility which is accessed via the 3-way JST connector, J2. To shut down the bias, either connect the \overline{SD} (top) pin to ground, or apply 5-12V DC to the SD pin (centre). The bottom pin is ground. Note the BIAS ON LED will illuminate when bias is applied to the transistor and turn off when the bias is disabled, which can act as a useful PTT (push-to-talk) indicator.

Advanced Operation

For those that wish to build on their amplifier project even further, we have provided outputs for thermal monitoring of the heatsink and voltage outputs proportional to the forward and reflected output power via a directional coupler after the low pass filter. The user may wish to design their own power meter, SWR



ENIGMA BROADCAST 2m 300W AMPLIFIER KIT v2

protection scheme or thermal monitoring of the heatsink for fan control or temperature readout.

The 4-way edge connector provides these outputs in a handy format. Just below the connector are (from left to right) labels identifying Ground, F (Forward power), R (Reflected power) and T (temperature). Simply use the 4-way cable provided to connect these outputs to your own equipment.

The forward and reflected ports are simple Schottky diode detectors followed by potential dividers halving the output voltage of each detector. At 350W output into a 50Ω load, the forward port will output about 3.2V and the reflected about 1.1V, both suitable for connecting directly to a microcontroller.

The thermal sensor is a precision 1% 10K thermistor, type MF52 (B value 3950) connected via a 3.9K resistor to the on-board 5V reference, again as a potential divider. At 25°C the output will be in the region of 1.4V, increasing with increasing temperature.

We sincerely hope you get enjoyment from using this product and welcome any feedback or comments. Please email us at info@enigma-shop.com

Specifications

Power Gain: >22dB @48V/ 50mA bias

Efficiency: Approximately 70% @350W/ 48V (FM mode)

Harmonic output: <-70dBc, 140-150MHz

Current draw: Typical 10A at 48V

Mismatch ruggedness: >SWR 65:1. Tested into open and short circuit loads at the output without damage.

Size: 150 (L) x 100 (W) x 75 (H)mm, mounted on Enigma HS150 heatsink.



ENIGMA BROADCAST 2m 300W AMPLIFIER KIT v2

Typical output spectrum @ 350W output, 48V

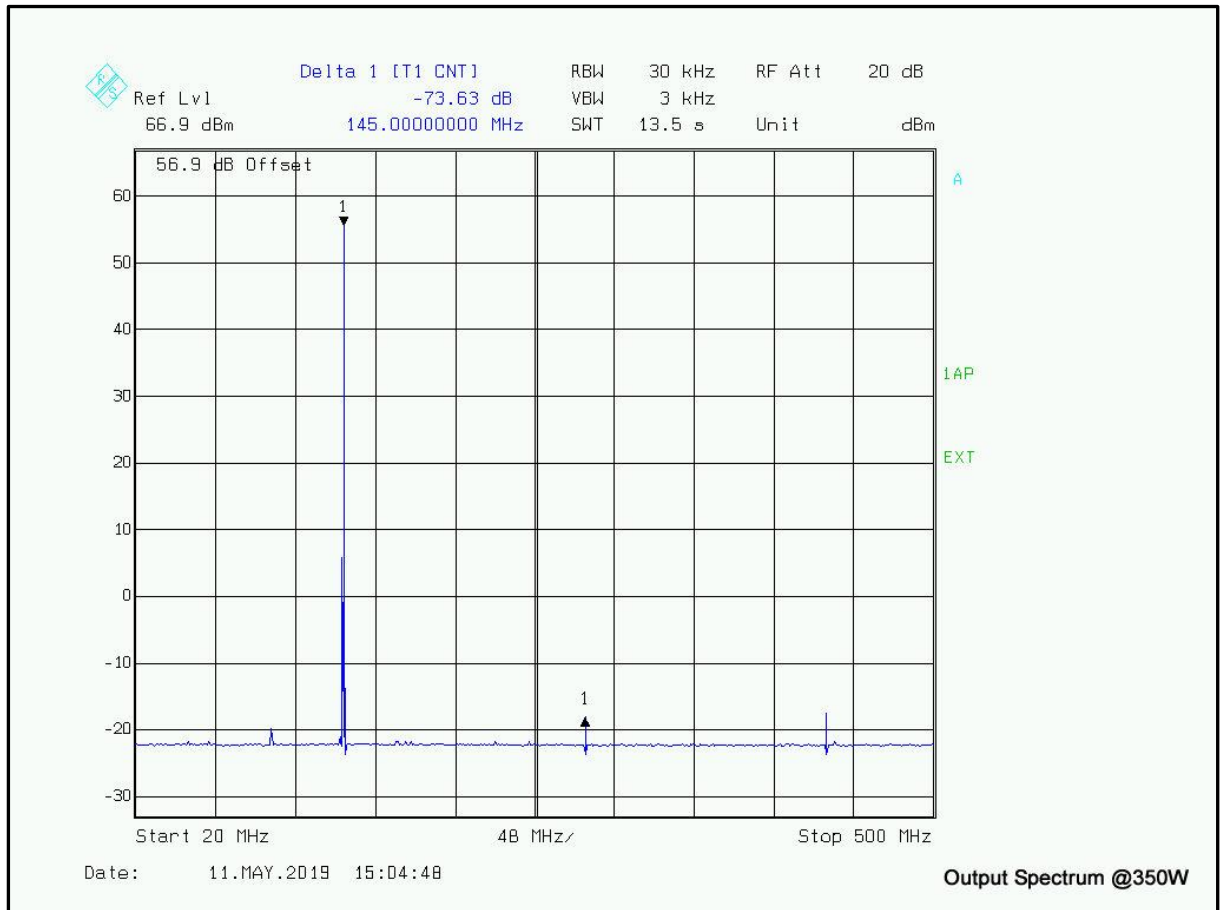



ENIGMA BROADCAST 2m 300W AMPLIFIER KIT v2

IMD Performance at 250W PEP, Bias 650mA

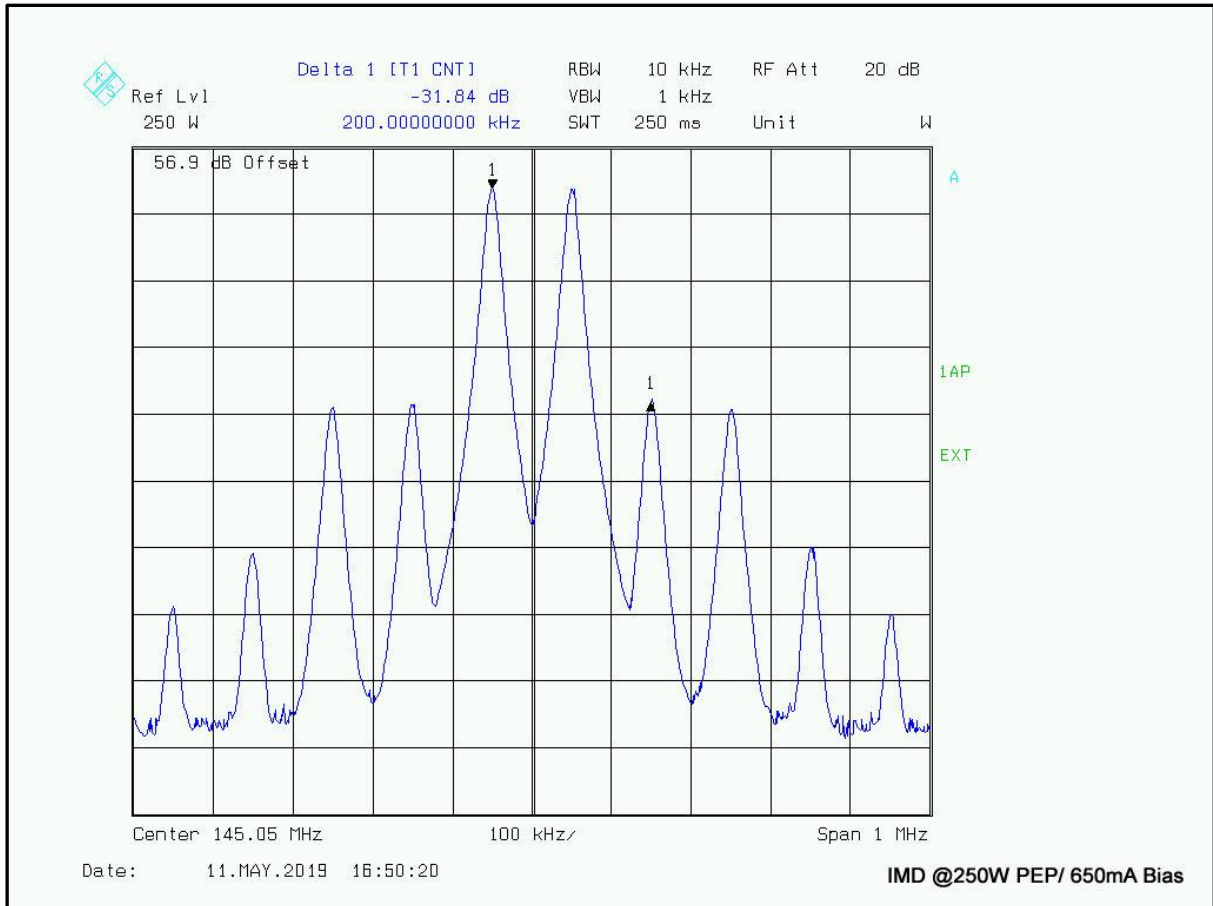



ENIGMA
BROADCAST

ENIGMA BROADCAST 2m 300W AMPLIFIER KIT v2

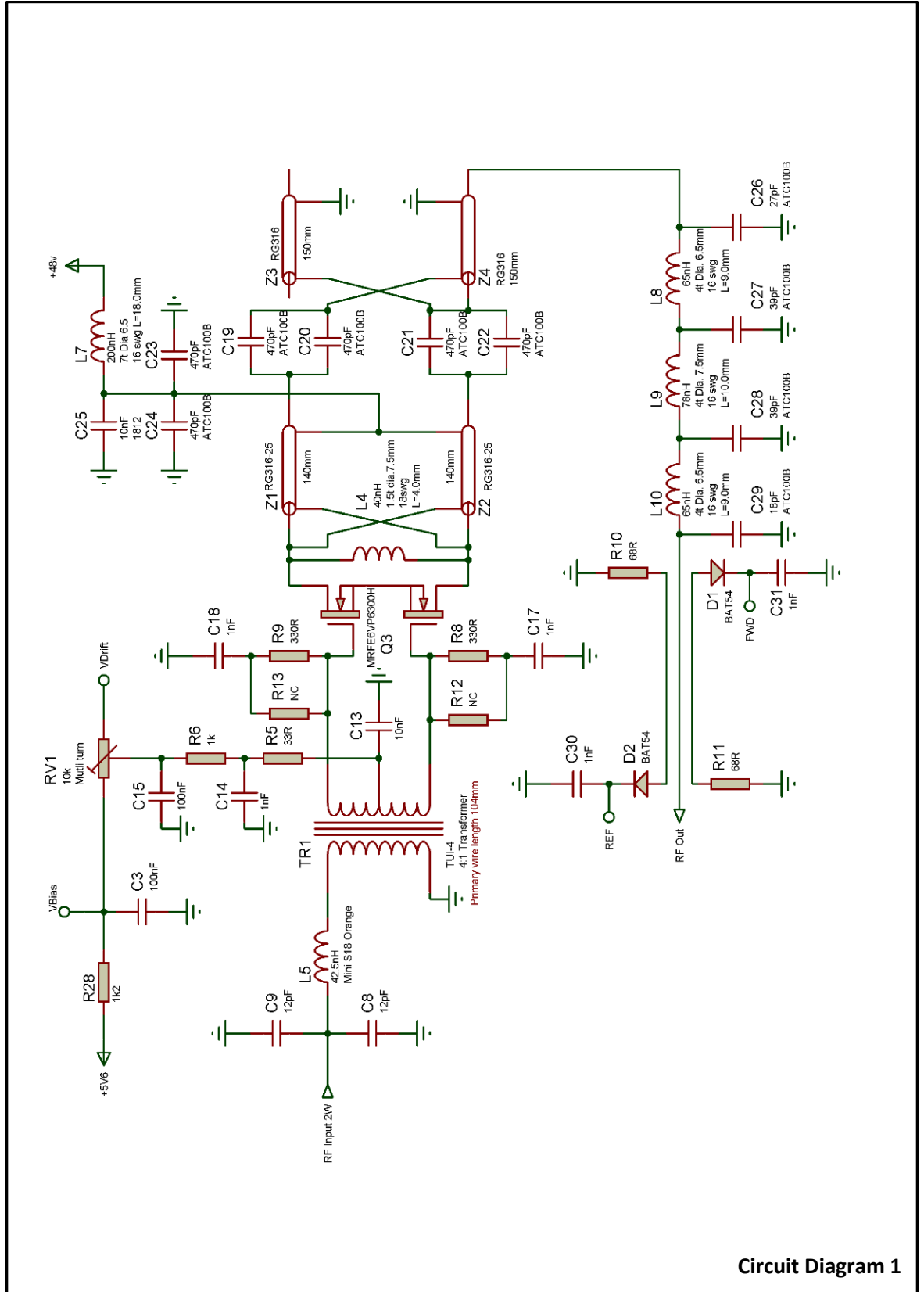

ENIGMA BROADCAST

2m 300W AMPLIFIER KIT

v2

