



Electric Ceramic Cooktop

Live Smart, Better Life!

CHTB302 & CHTB775

Instruction / Installation Manual

☎ 1 (844) 334-4203

🌐 www.thermomate.com

✉ support@thermomate.com

📍 3330-A Marathon Ct Charleston, SC 29418

Safety Warnings

Your safety is important to us. Please read this information before using your cooktop.

Installation

Electrical Shock Hazard

- Disconnect the appliance from the main electricity supply before carrying out any work or maintenance on it.
- Connection to a good earth wiring system is essential and mandatory.
- Alterations to the domestic wiring system must only be made by a qualified electrician.
- Failure to follow this advice may result in electrical shock or death.

Cut Hazard

- Take care - panel edges are sharp.
- Failure to use cautiously could result in injury or cuts.

Important Safety Instructions

- Read these instructions carefully before installing or using this appliance.
- No combustible material or products should be placed on this appliance at any time.
- Please make this information available to the person who responsible for installing the appliance as it could reduce your installation costs.
- In order to avoid a hazard, this appliance must be installed according to these instructions for installation.
- This appliance is to be properly installed and earthed only by a suitable qualified technician.
- This appliance should be connected to a circuit which incorporates an isolating switch providing full disconnection from the power supply.
- Failure to install the appliance correctly could invalidate any warranty or liability claims.



Operation and Maintenance

Electrical Shock Hazard

- Do not cook on a broken or cracked cooktop. If the cooktop surface should break or crack, switch the appliance off immediately at the main power supply (wall switch) and contact a qualified technician.
- Switch the cooktop off at the wall before cleaning or maintenance.
- Failure to follow this advice may result in electrical shock or death.

Health Hazard

- There is nothing to worry about this appliance complies with electromagnetic safety standards.

Scald Hazard

- During use, accessible parts of this appliance will become hot enough to cause burns.
- Do not let your body, clothing or any item other than suitable cookware contact the induction glass until the surface is cool.
- Metallic objects such as knives, forks, spoons and lids should not be placed on the cooktop surface since they can get hot.
- Keep children away.
- Handles of saucepans may be hot to touch. Make sure saucepan handles do not overhang other cooking zones that are on. Also, keep the handles out of reach of children.
- Failure to follow this advice could result in burns and scalds.

Cut Hazard

- The razor-sharp blade of a cooktop scraper is exposed when the safety cover is retracted. Use with extreme care and always store safely and out of reach of children.
- Failure to use cautiously could result in injury or cuts.

Important Safety Instructions

- Never leave the appliance unattended when in use. Boilover causes smoking and greasy spillovers that may ignite.
- Never use your appliance as a work or storage surface.
- Never leave any objects or utensils on the appliance.
- Never use your appliance for warming or heating the room.
- After use, always turn off the cooking zones and the cooktop as described in this manual (i.e. by using the touch controls).
- Do not allow children to play with the appliance or sit, stand, or climb on it.
- Do not store items of interest to children in cabinets above the appliance. Children who climbing on the cooktop could be seriously injured.
- Do not leave children alone or unattended in the area where the appliance is in use.
- Children or persons with a disability which limits their ability to use the appliance should have a responsible and competent person to instruct them in its use. The instructor should be confirmed that they can use the appliance without doing danger to themselves or their surroundings.
- Do not repair or replace any part of the appliance unless specifically recommended in the manual. All other servicing should be done by a qualified technician.
- Do not use a steam cleaner to clean your cooktop.
- Do not place or drop heavy objects on your cooktop.
- Do not stand on your cooktop.
- Do not use pans with jagged edges or drag pans across the Induction glass surface as this can scratch the glass.
- Do not use scourers or any other harsh abrasive cleaning agents to clean your cooktop, as these can scratch the Induction glass.
- If the supply cord is damaged, it must be replaced by the manufacturer, its service agent or similarly qualified persons in order to avoid a hazard.
- This appliance is intended to be used in household and similar applications such as:
 - staff kitchen areas in shops, offices and other working environments;
 - farm houses;
 - by clients in hotels, motels and other residential type environment;
 - bed and breakfast type environments.
- **WARNING:** The appliance and its accessible parts become hot during use. Care should be taken to avoid touching heating elements. Children less than 8 years of age shall be kept away unless continuously supervised.
- This appliance can be used by children aged from 8 years and above and persons with reduced physical, sensory or mental capabilities or lack of experience and knowledge if they have been given supervision or



instruction concerning use of the appliance in a safe way and understand the hazards involved.

- Children shall not play with the appliance. Cleaning and user maintenance shall not be made by children without supervision.
- **WARNING:** Unattended cooking on a cooktop with fat or oil can be dangerous and may result in fire. NEVER try to extinguish a fire with water, but switch off the appliance and then cover flame e.g. with a lid or a fire blanket.
- **WARNING:** Danger of fire: Do not store items on the cooking surfaces.
- **WARNING:** If the surface is cracked, switch off the appliance to avoid the possibility of electric shock, for cooktop surfaces of glass-ceramic or similar material protect live parts.
- A steam cleaner should not be used.
- The appliance is not intended to be operated by means of an external timer or separate remote-control system.

Congratulations

On the purchase of your new ceramic cooktop. We recommend that you spend some time to read this Instruction / Installation Manual in order to fully understand how to correctly install and operate it. For installation, please read the installation section. Read all the safety instructions carefully before use and keep this Instruction / Installation Manual for future reference.

Product Overview

CHTB302

Top view

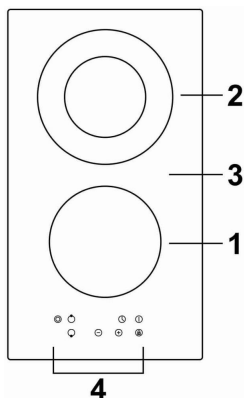

1. Max. 1200 W zone
2. Max. 2000(1000) W zone
3. Glass plate
4. Control panel

Control Panel

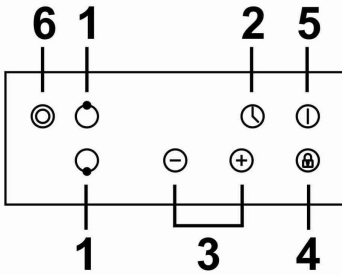

- 1. Heating zone selection controls
- 2. Timer control
- 3. Power/Timer regulating controls
- 4. Keylock control
- 5. ON/OFF control
- 6. Dual Zone

CHTB775

Top View

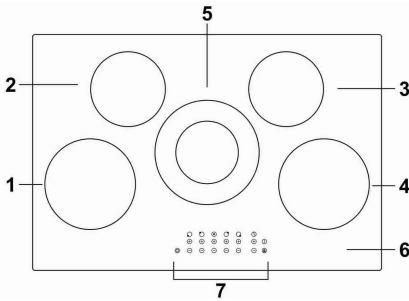

- 1. Max. 1800 W zone
- 2. Max. 1200 W zone
- 3. Max. 1200 W zone
- 4. Max. 1800 W zone
- 5. Max. 2200/1000 W zone
- 6. Glass plate
- 7. Control panel

Control Panel

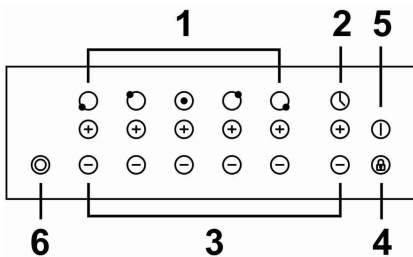

- 1. Heating zone selection indicator
- 2. Timer control
- 3. Power/Timer regulating controls
- 4. Keylock control
- 5. ON/OFF control
- 6. Dual Zone



Product Information

The ceramic cooktop can meet different kinds of cuisine demands with its resistance wire heating, micro-computerized control and multi-power selection, indeed the optimal choice for modern families.

The ceramic cooktop centers on customers and adopts personalized design. The cooktop has safe and reliable performances, making your life comfortable and enabling to fully enjoy the pleasure from life.

Before Using Your New Ceramic Cooktop

- Read this guide, taking special note of the 'Safety Warnings' section.
- Remove any protective film that may still be on your ceramic cooktop.

Using The Touch Controls

- The controls respond to touch, so you don't need to apply any pressure.
- Use the ball of your finger, not its tip.
- You will hear a beep each time a touch is registered.
- Make sure the controls are always clean, dry, and that there is no object (e.g. a utensil or a cloth) covering them. Even a thin film of water may make the controls difficult to operate.

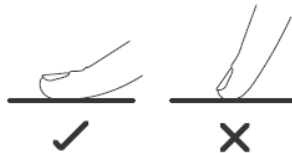

Choosing The Right Cookware

Do not use cookware with jagged edges or a curved base.



Make sure that the base of your pan is smooth, sits flat against the glass, and is the same size as the cooking zone. Always centre your pan on the cooking zone.

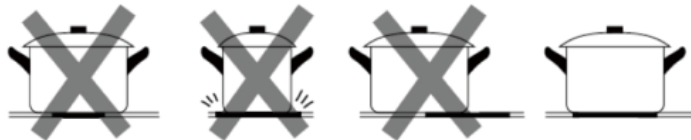

Always lift pans off the ceramic cooktop – do not slide, or they may scratch the glass.

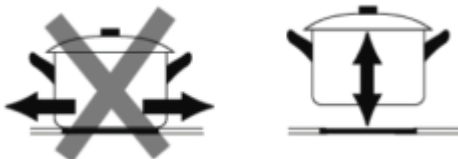

Using Your Ceramic Cooktop

To start cooking

- After power on, the buzzer beeps once, all the indicators light up for 1 second then go out, indicating that the ceramic cooktop has entered the state of standby mode.

1. Touch the ON/OFF  control. All the indicators show “-”.



2. Place a suitable pan on the cooking zone that you hope to use.

- Make sure the bottom of the pan and the surface of the cooking zone are clean and dry.

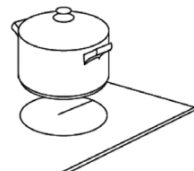

3. For model CHTB302, select a heat setting by touching the cooking zone button.



For model CHTB775, select a heat setting by touching the “-” or “+”.



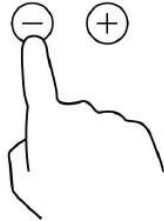

4. Select a power level by touching the “-” or “+” control.

- If you don't choose a heat setting within 1 minute, the ceramic cooktop will automatically switch off. You will need to start again at step 1.
- You can modify the heat setting at any time during cooking.
- By holding down either of these buttons, the heat setting will adjust up or down.



or



5. For the zone with double ring, you can activate it by pressing , When double zone is working, you could turn off double zone by pressing .

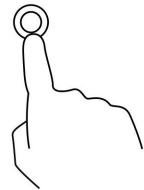

When You Have Finished Cooking

1. Touch the heating zone selection control of the zone you hope to switch off.



Model CHTB302



Model CHTB775

2. Turn the cooking zone off by touching the “-” and scrolling down to “0”.



3. Turn the whole cooktop off by touching the “ON/OFF” control.

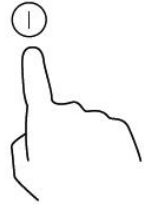

4. Beware of hot surfaces

“H” will show which cooking zone is hot to touch. It will disappear when the surface has cooled down to a safe temperature. It can also be used as an energy saving function if you want to heat further pans, use the cooktop that is still hot.



Locking the Controls

- You can lock the controls to prevent unintended use (for example children accidentally turning the cooking zones on).
- When the controls are locked, all the controls except the ON/OFF control are disabled.

To lock the controls

Touch the keylock  control. The timer indicator will show “Lo”.

To unlock the controls

1. Make sure the ceramic cooktop is turned on.
2. Touch and hold the keylock control  for a while.
3. You can now start using your ceramic cooktop.



When the cooktop is in the lock mode, all the controls are disable

except the ON/OFF  , you can always turn the ceramic cooktop

off with the ON/OFF  control in emergency, but you shall unlock the cooktop first in the next operation.



Over-Temperature Protection

The ceramic cooktop employed a temperature sensor that can monitor the temperature inside. When an excessive temperature is monitored, the ceramic cooktop will stop operation automatically.

Residual Heat Warning

When the cooktop has been operating for some time, there will be some residual heat. The letter “H” appears to warn you to keep away from the hot surface.

Auto Shutdown

Another safety feature of the cooktop is auto shut down. This occurs whenever you forget to switch off a cooking zone. The default shutdown time are shown in the table below:

Power level	1	2	3	4	5	6	7	8	9
Default working timer (hour)	8	8	8	4	4	4	2	2	2

Using the Timer

You can use the timer in two different ways:

- You can use it as a minute minder. In this case, the timer will not turn any cooking zone off when the set time is up.
- You can set it to turn one cooking zone off or more than one after the set time is up.
- You can set the timer for up to 99 minutes.

Using The Timer As A Minute Minder

If you are not selecting any cooking zone

1. Make sure the cooktop is turned on.

Note: you can use the minute minder even if you're not selecting any cooking zones.

2. For model CHTB302, touch the timer control, the timer indicator show "--".

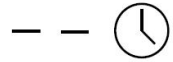

For model CHTB775, touch the "-" or "+" controls of the timer, the minute minder indicator will flash.

3. Adjust the timer setting by touch the "-" or "+" controls. The minute minder indicator will start flashing and will show in the timer display.

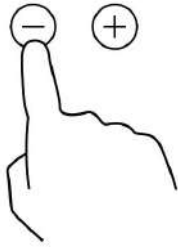

Model CHTB302



Model CHTB775

Hint: Touch the "-" or "+" control of the timer once to decrease or increase by 1 minute.

Touch and hold the "-" or "+" control of the timer to decrease or increase by 10 minutes.

If the setting time exceeds 99 minutes, the timer will automatically return to 0 minute.

4. Touching the heating zone selection control, and then touch the 'Timer', the timer is cancelled, and the "--" will show in the minute display.

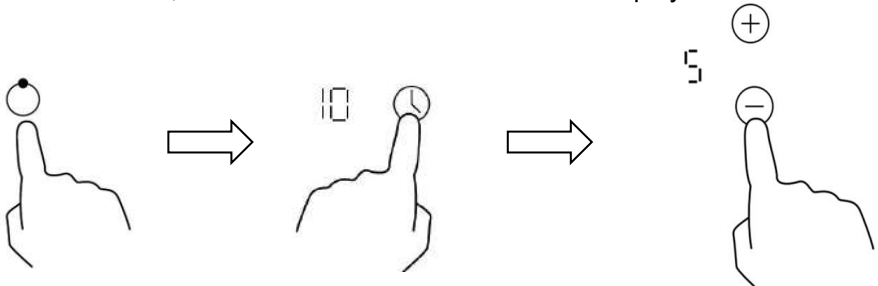

5. When the time is set, it will begin to count down immediately. The display will show the remaining time and the timer indicator will flash for 5 seconds.

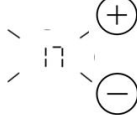

Model CHTB302 Model CHTB775 

6. Buzzer will beep for 30 seconds and the timer indicator shows “- -” when the set time finished.

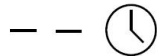
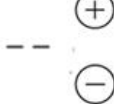
Model CHTB302 Model CHTB775 

Setting The Timer To Turn One Cooking Zone Off (Model CHTB302)

1. Touching the heating zone selection control.



2. Touch the timer control, the timer indicator show “30”.



3. Set the time by touching the control of the timer.



Hint: Touch the “-” or “+” control of the timer once will decrease or increase by 1 minute.

Touch and hold the “-” or “+” control of the timer will decrease or increase by 10 minutes.

If the setting time exceeds 99 minutes, the timer will automatically return to 0 minute.

4. Touching the heating zone selection control, and then touch the 'Timer', the timer is cancelled, and the "--" will show in the minute display.

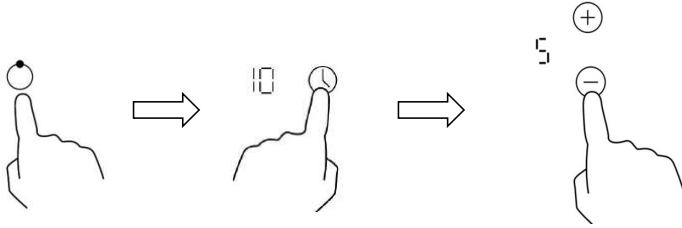

5. When the time is set, it will begin to count down immediately. The display will show the remaining time and the timer indicator flash for 5 seconds.

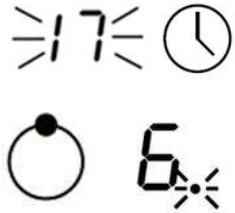

NOTE: The red dot next to power level indicator will illuminate indicating that zone is selected.

Setting The Timer To Turn One Cooking Zone Off (Model CHTB775)

1. Touch the \ominus or \oplus of the corresponding cooking zone you want to set the timer for.

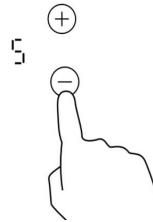

2. Set the time by touching the \ominus or \oplus control of the timer, and touch \ominus or \oplus to set the power to the level you want.

Hint: Touch the \ominus or \oplus buttons once to decrease or increase by 1 minute.



Touch and hold the \ominus or \oplus buttons to decrease or increase the timer by 10 minutes.

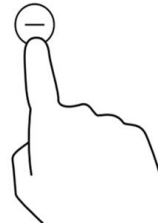

If the setting time exceeds 99 minutes, the timer will automatically return to 0 minute.

3. When the time is set, it will begin to count down immediately. The display will show the remaining time and the timer indicator flash for 5 seconds.

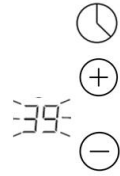

NOTE: The red dot next to power level indicator will illuminate indicating that zone is selected.

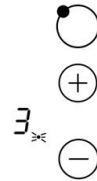

4. When cooking timer expires, the corresponding cooking zone will be switched off automatically.

NOTE: If you want to change the time after the timer is set, you have to start from step 1.

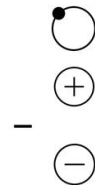

Setting The Timer To Turn More Than One Cooking Zone Off (Model CHTB302)

1. If more than one heating zone use this function, the timer indicator will show the lowest time.
(e.g. zone 1# setting time of 6 minutes, zone 2# setting time of 3 minutes, the timer indicator shows "3".)

NOTE: The red dot next to power level indicator will flash.

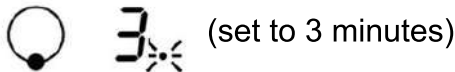
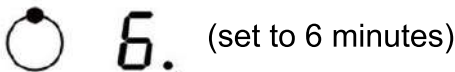

2. When cooking timer expires, the corresponding cooking zone will be switched off automatically.



NOTE: If you want to change the time after the timer is set, you have to start from step 1.

Setting The Timer To Turn More Than One Cooking Zone Off (Model CHTB775)

- If more than one heating zone use this function, the timer indicator will show the lowest time.
(e.g. zone 1# setting time of 6 minutes, zone 2# setting time of 5 minutes, the timer indicator shows "5".)

NOTE: The red dot next to power level indicator will flash.

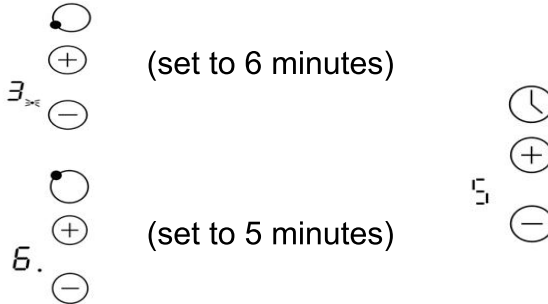

- When cooking timer expires, the corresponding cooking zone will be switched off automatically.

NOTE: If you want to change the time after the timer is set, you have to start from step 1.

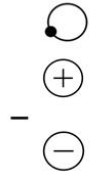

Cooking Guidelines

Cooking Tips

- When food comes to the boil, reduce the power setting.
- Using a lid will reduce cooking times and save energy by retaining the heat.
- Minimise the amount of liquid or fat to reduce cooking times.
- Start cooking on a high setting and reduce the setting when the food has heated through.

Simmering, cooking rice

- Simmering occurs below boiling point, at around 85°C, when bubbles are just rising occasionally to the surface of the cooking liquid. It is the key to delicious soups and tender stews because the flavours develop without overcooking the food. You should also cook egg-based and flour-thickened sauces below boiling point.



- Some tasks, including cooking rice by the absorption method, may require a setting higher than the lowest setting to ensure the food is cooked properly in the time recommended.

Searing steak

To cook juicy flavoursome steaks:

1. Stand the meat at room temperature for about 20 minutes before cooking.
2. Heat up a heavy-based frying pan.
3. Brush both sides of the steak with oil. Drizzle a small amount of oil into the hot pan and then lower the meat onto the hot pan.
4. Turn the steak only once during cooking. The exact cooking time will depend on the thickness of the steak and how cooked you want it. Time may vary from 2 – 8 minutes per side. Press the steak to gauge how cooked it is – the firmer it feels the more 'well done' it will be.
5. Leave the steak to rest on a warm plate for a few minutes to allow it to relax and become tender before serving.

For stir-frying

1. Choose a ceramic compatible flat-based wok or a large frying pan.
2. Have all the ingredients and equipment ready. Stir-frying should be quick. If cooking large quantities, cook the food in several smaller batches.
3. Preheat the pan briefly and add two tablespoons of oil.
4. Cook any meat first, put it aside and keep warm.
5. Stir-fry the vegetables. When they are hot but still crisp, turn the cooking zone to a lower setting, return the meat to the pan and add your sauce.
6. Stir the ingredients gently to make sure they are heated through.
7. Serve immediately.

Heat Settings

Heat setting	Suitability
1 - 2	<ul style="list-style-type: none"> • Delicate warming for small amounts of food • Melting chocolate, butter, and foods that burn quickly • Gentle simmering • Slow warming
3-4	<ul style="list-style-type: none"> • Reheating • Rapid simmering • Cooking rice
5-6	<ul style="list-style-type: none"> • Pancakes
7-8	<ul style="list-style-type: none"> • Sauteing • Cooking pasta

9	<ul style="list-style-type: none"> ● Stir-frying ● Searing ● Bringing soup to the boil ● Boiling water
---	--------------------------------------------------------------------------------------------------------------------------------------------------

Technical Specification

Model	CHTB302	CHTB775
Cooking Zones	2 Zones	5 Zones
Supply Voltage / Frequency	220-240V~ 50-60Hz	220-240V~ 50-60Hz
Rating Power	2928W-3484W	7502W-8929W
Product Size L×W×H(in)	11 ¹ / ₂ x 20 ¹ / ₂ x 2	30 ¹ / ₃ x 20 ¹ / ₂ x 2
Built-in Dimensions A×B (in)	10 ³ / ₅ x 19 ⁴ / ₅	29 ¹ / ₅ x 19 ¹ / ₃

Weight and Dimensions are approximate. Because we continually strive to improve our products we may change specifications and designs without prior notice.

Care And Cleaning

What?	How?	Important!
Everyday soiling on glass (fingerprints, marks, stains left by food or non-sugary spillovers on the glass)	<ol style="list-style-type: none"> 1. Switch the power to the cooktop off. 2. Apply a cooktop cleaner while the glass is still warm (but not hot!) 3. Rinse and wipe dry with a clean cloth or paper towel. 4. Switch on the power to the cooktop again. 	<ul style="list-style-type: none"> ● When the power to the cooktop is switched off, there will be no 'hot surface' indication but the cooking zone may still be hot! Take extreme care. ● Heavy-duty scourers, some nylon scourers and harsh/abrasive cleaning agents may scratch the glass. Always read the label to check if your cleaner or scourer is suitable. ● Never leave cleaning residue on the cooktop: the glass may become stained.



Boilovers, melts, and hot sugary spills on the glass	<p>Remove these immediately with a fish slice, palette knife or razor blade scraper suitable for ceramic glass cooktops, but beware of hot cooking zone surfaces:</p> <ol style="list-style-type: none"> 1. Switch the power to the cooktop off at the wall. 2. Hold the blade or utensil at a 30° angle and scrape the soiling or spill to a cool area of the cooktop. 3. Clean the soiling or spill up with a dish cloth or paper towel. 4. Follow steps 2 to 4 for 'Everyday soiling on glass' above. 	<ul style="list-style-type: none"> • Remove stains left by melts and sugary food or spillovers as soon as possible. If left to cool down on the glass, they may be difficult to remove or even permanently damage the glass surface. • Cut hazard: when the safety cover is retracted, the blade in a scraper is razor-sharp. Use with extreme care and always store safely and out of reach of children.
Spillovers on the touch controls	<ol style="list-style-type: none"> 1. Switch the power to the cooktop off. 2. Soak up the spill. 3. Wipe the touch control area with a clean damp sponge or cloth. 4. Wipe the area completely dry with a paper towel. 5. Switch on the power to the cooktop again. 	<ul style="list-style-type: none"> • The cooktop may beep and turn itself off, and the touch controls may not function while there is liquid on them. Make sure you wipe the touch control area dry before turning the cooktop back on.

Hints And Tips

Problem	Possible causes	What to do
The cooktop cannot be turned on.	No power.	<p>Make sure the cooktop is connected to the power supply and that it is switched on.</p> <p>Check whether there is a power outage in your home or area. If you've checked everything and the problem persists, call a qualified technician.</p>
The touch controls are unresponsive.	The controls are locked.	<p>Unlock the controls. See section 'Using your ceramic cooktop' for instructions.</p>

<p>The touch controls are difficult to operate.</p>	<p>There may be a slight film of water over the controls or you may be using the tip of your finger when touching the controls.</p>	<p>Make sure the touch control area is dry and use the ball of your finger when touching the controls.</p>
<p>The glass is being scratched.</p>	<p>Rough-edged cookware. Unsuitable, abrasive scourer or cleaning products being used.</p>	<p>Use cookware with flat and smooth bases. See 'Choosing the right cookware'. See 'Care and cleaning'.</p>
<p>Some pans make cracking or clicking noises.</p>	<p>This may be caused by the construction of your cookware (layers of different metals vibrating differently).</p>	<p>This is normal for cookware and does not indicate a fault.</p>

Installation

Cutting out work surface

1. Cut out the work surface according to the sizes shown in the drawing. For the purpose of installation and use, a minimum of 2 inches (50mm) space shall be preserved around the hole. Be sure the thickness of the work surface is at least 1.2 inches (30mm). Please select heat-resistant work surface material to avoid larger deformation caused by the heat radiation from the cooktop. As shown below:

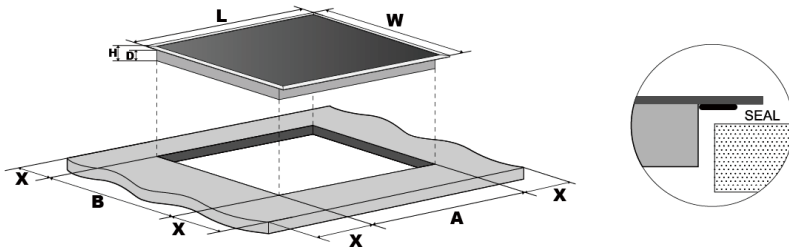

Model	L	W	H	D	A	B	X
CHTB302	11½ in	20½ in	2 in	1 ⁹ / ₁₀ in	10 ³ / ₅ in	17 ⁴ / ₅ in	2 in mini
CHTB775	30 ¹ / ₃ in	20½ in	2 in	1 ⁹ / ₁₀ in	29 ¹ / ₅ in	19 ¹ / ₃ in	2 in mini



Under any circumstances, make sure the ceramic cooktop is well ventilated and the air inlet and outlet are not blocked. Ensure the ceramic cooktop is in good work state as shown below.

⚠ Note: The safety distance between the cooktop and the cupboard above the cooktop should be at least 30 inches (760mm).

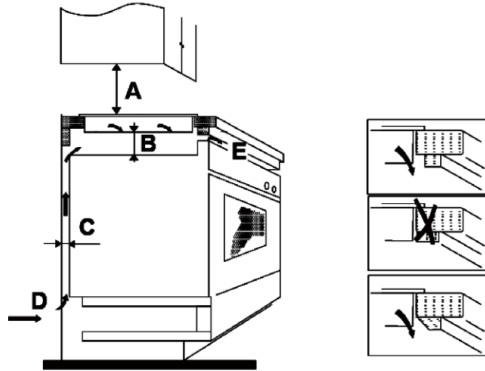

A	B	C	D	E
30 in	2 in mini	$\frac{4}{5}$ in mini	Air intake	Air exit $\frac{1}{5}$ in

Before Locating The Fixing Brackets

1. The unit should be placed on a stable, smooth surface (use the packaging). Do not apply force onto the controls protruding from the cooktop.
2. Fix the cooktop on the work surface by screw four brackets on the bottom of cooktop (see picture) after installation.

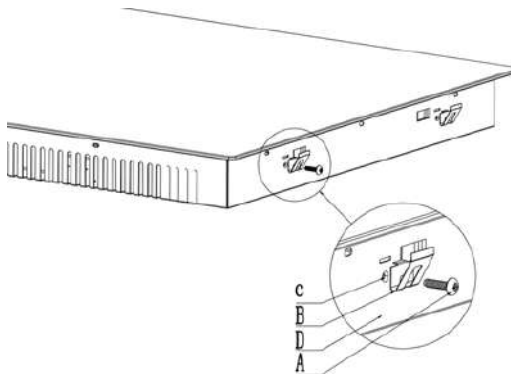

A	B	C	D
Screw	Bracket	Screw Hole	Bottom/Housing

3. Insert the appliance into the installation opening.

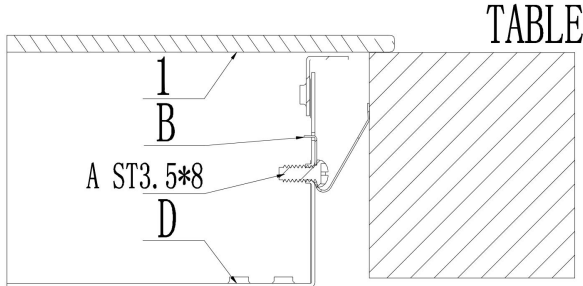

Cautions

1. The ceramic cooktop must be installed by qualified personnel or technicians. We have professionals at your service. Please never conduct the operation by yourself.
2. The ceramic cooktop shall not be mounted to cooling equipment, dishwashers and rotary dryers.
3. The ceramic cooktop shall be installed as the manual required so better heat radiation can be ensured to enhance its reliability.
4. The wall and induced heating zone above the work surface shall withstand heat.
5. To avoid any damage, the sandwich layer and adhesive must be resistant to heat.
6. A steam cleaner should not be used.
7. This ceramic cooktop can only be connected to a supply with system impedance no more than 0.427 ohm. If necessary, please consult your supply authority for system impedance information.

Connecting The Cooktop To The Main Power Supply

The power supply should be connected in compliance with the relevant standard, or connected to a single-pole circuit breaker. The method of connection is shown below.



1 (844) 334-4203

© www.thermomate.com

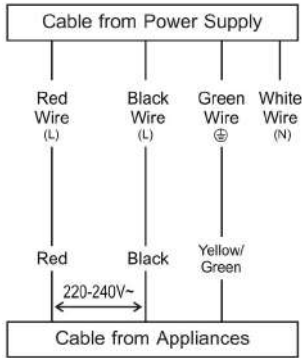

Model CHTB302

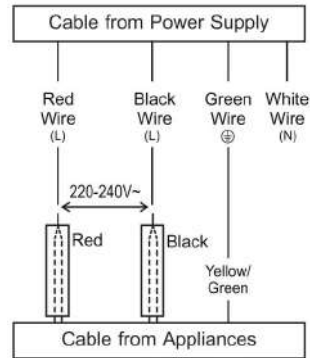

Model CHTB775

1. If the cable is damaged or needs replacing, this should be done by an after-sales technician using the proper tools to avoid any accidents.
2. If the appliance is directly connected to the main supply, an omnipolar circuit breaker must be installed with a minimum gap of 3mm between the contacts.
3. The installer must ensure that the correct electrical connection has been made and that it complies with safety regulations.
4. The cable must not be bent or compressed.
5. The cable must be checked regularly and only replaced by a properly qualified person.



DISPOSAL: Do not dispose this product as unsorted municipal waste. Collecting such waste separately for special treatment is necessary.

This appliance is labeled in compliance with European directive 2012/19/EU for Waste Electrical and Electronic Equipment (WEEE). By ensuring that this appliance is disposed of correctly, you will help prevent any possible damage to the environment and to human health, which might otherwise be caused if it were disposed of in the wrong way.

The symbol on the product indicates that it may not be treated as normal household waste. It should be taken to a collection point for the recycling of electrical and electronic goods.

This appliance requires specialist waste disposal.

For more detailed information about treatment, recovery and recycling of this product, please contact your local city office, your household waste disposal service or the shop where you purchased the product.

☎ 1 (844) 334-4203

🌐 www.thermomate.com

✉ support@thermomate.com

📍 3330-A Marathon Ct Charleston, SC 29418

