



THE INFORMATION PROVIDED BY EPOWERON ("WE, "US", or "OUR") IN THIS CATALOG IS FOR GENERAL PURPOSES ONLY. ALL INFORMATION IN THE CATALOG IS PROVIDED IN GOOD FAITH, HOWEVER WILL WE MAKE NO REPRESENTATION OR WARRANTY OF ANY KIND, EXPRESS OR IMPLIED, REGARDING THE ACCURACY, ADEQUACY, RELIABILITY, AVAILABILITY OR COMPLETEESS OF ANY INFORATION IN THIS CATALOG.



CONTENT FOR ELECTRICAL BOX & GFCI

PLASTIC ELECTRIC BOX

1-8	NEW WORK PLASTIC BOX
9-10	OLD WORK BOX
11-12	DUAL VOLTAGE BOX / LOW VOLTAGE BRACKET
13	OLD WORK BRACKET/ BOX EXTENDER
14-15	COVERS
16	FIBERGLASS (BMC) BOX
17	OUTLET BOX EXTENDER

GFCI & USB RECEPTACLE

18-20	DUAL USB RECEPTACLE
21-23	GFCI RECEPTACLE

EMT AND ROUGH-IN MATERIAL

24-28	WEATHERPROOF BOX/COVER
29-33	CONDUIT BODIES
34-47	EMT AND RIGID
48-52	BOX SUPPORT
53-55	LIQUID TIGHT
56-62	FLEX & NM & SE
63	DOOR CHIME



New Work Box

One-Gang Nail-On



APB118N



APB120N



APB123N



Part No.	Cubic Capacity	Description	Products Size L×W×D	Outer Box Size L×W×D(cm)	STD. CTN. QTY.
APB118N	18 cu in Four Knockouts	2-7/8" Deep; New Work; 1-Gang; Captive Nail Mounting; For Use With Non-Metallic Sheathed Cable.	2-1/4"×3-3/4"×2-7/8"	54×37.5×24	100
APB120N	20 cu in Four Knockouts	3-1/4" Deep; New Work; 1-Gang; Captive Nail Mounting; For Use With Non-Metallic Sheathed Cable.	2-1/4"×3-3/4"×3-1/4"	54×34×29.5	100
APB123N	23 cu in Four Knockouts	3-1/2" Deep; New Work; 1-Gang; Captive Nail Mounting; For Use With Non-Metallic Sheathed Cable.	2-1/4"×3-3/4"×3-1/2"	54×37×29.5	100

One, Two, Three and Four-Gang Nail-On



APB01N



APB02N

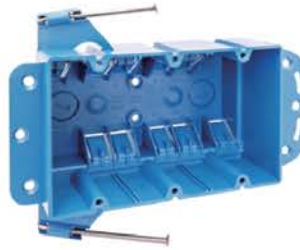

APB03N



APB04N



Part No.	Cubic Capacity	Description	Products Size L×W×D	Outer Box Size L×W×D(cm)	STD. CTN. QTY.
APB01N	18 cu in Four Integral Clamps	New Work; 1-Gang; Captive Nail Mounting; Switch and Outlet Box with Wire Clamps; For Use With Non-Metallic Sheathed Cable.	2-1/4"×3-3/4"×2-7/8"	54×37.5×24	100
APB02N	32 cu in Six Integral Clamps	New Work; 2-Gang; Captive Nail Mounting; Switch and Outlet Box with Wire Clamps; For Use With Non-Metallic Sheathed Cable.	4"×3-3/4"×3"	52.5×46.5×25.5	60
APB03N	44 cu in Ten Integral Clamps	New Work; 3-Gang; Captive Nail and Bracket Support Mounting; Switch and Outlet Box with Wire Clamps; For Use With Non-Metallic Sheathed Cable.	5-7/8"×3-3/4"×2-3/4"	45×38×27.5	30
APB04N	55 cu in Fourteen Integral Clamps	New Work; 4-Gang; Captive Nail and Bracket Support Mounting; Switch and Outlet Box with Wire Clamps; For Use With Non-Metallic Sheathed Cable.	7-7/10"×3-3/4"×2-3/4"	46×46×27	30



New Work Box

One, Two, Three and Four-Gang Nail-On(DEEP)

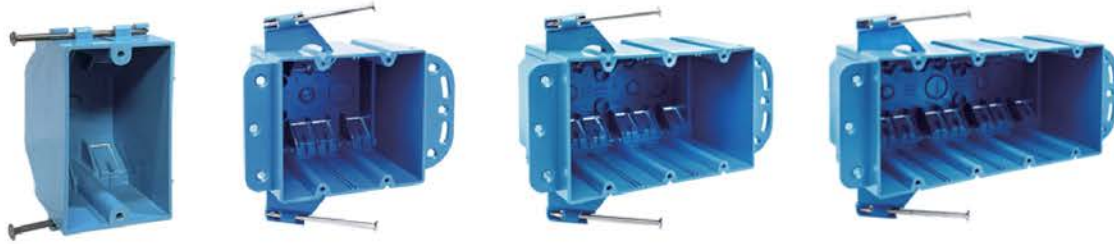

APB01DN

APB02ND

APB03ND

APB04ND



Part No.	Cubic Capacity	Description	Products Size L×W×D	Outer Box Size L×W×D(cm)	STD. CTN. QTY.
APB01DN	23 cu in Four Integral Clamps	Deep; New Work; 1-Gang; Captive Nail Mounting; Switch and Outlet Box with Wire Clamps; For Use With Non-Metallic Sheathed Cable.	2-1/4"×3-3/4"×3-1/2"	54×37.5×24	100
APB02ND	44 cu in Six Integral Clamps	Deep; New Work; 2-Gang; Captive Nail and Bracket Support Mounting; Switch and Outlet Box with Wire Clamps; For Use With Non-Metallic Sheathed Cable.	4"×3-3/4"×4"	56×42.5×43	60
APB03ND	68 cu in Ten Integral Clamps	Deep; New Work; 3-Gang; Captive Nail and Bracket Support Mounting; Switch and Outlet Box with Wire Clamps; For Use With Non-Metallic Sheathed Cable.	5-7/8"×3-3/4"×4"	43×38×43	30
APB04ND	87 cu in Fourteen Integral Clamps	Deep; New Work; 4-Gang; Captive Nail and Bracket Support Mounting; Switch and Outlet Box with Wire Clamps; For Use With Non-Metallic Sheathed Cable.	7-7/10"×3-3/4"×4"	47.5×45.5×43	30

Two, Three and Four-Gang Nail-On

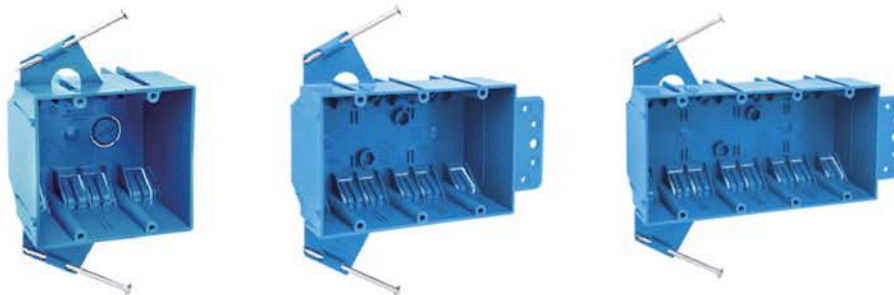

CPB232

CPB344

CPB455



Part No.	Cubic Capacity	Description	Products Size L×W×D	Outer Box Size L×W×D(cm)	STD. CTN. QTY.
CPB232	32 cu in Eight Integral Clamps	New Work; 2-Gang; Captive Nail Mounting; For Use With Non-Metallic Sheathed Cable.	4"×3-3/4"×3"	52.5×32.5×39.5	50
CPB344	44 cu in Twelve Integral Clamps	New Work; 3-Gang; Captive Nail and Bracket Support Mounting; For Use With Non-Metallic Sheathed Cable.	5-5/8"×3-3/4"×2-3/4"	50×37.5×31.5	30
CPB455	55 cu in Sixteen Integral Clamps	New Work; 4-Gang; Captive Nail and Bracket Support Mounting; For Use With Non-Metallic Sheathed Cable.	7-3/5"×3-3/4"×2-3/4"	50×46.5×31.5	30



New Work Box

4" Square



APB418A



APB432A



Part No.	Cubic Capacity	Description	Products Size L×W×D	Outer Box Size L×W×D(cm)	STD. CTN. QTY.
APB418A	18 cu in Eight Integral Clamps	New Work; 4" Square; Captive Nail and molded bracket Mounting; Switch and Outlet Box with Wire Clamps.	4"×4"×1-5/8"	53.5×31.5×30.5	50
APB432A	32 cu in Eight Integral Clamps	New Work; 4" Square; Captive Nail and Mounting; Switch and Outlet Box with Wire Clamps.	4"×4"×2-5/8"	52.5×35.2×34.5	50

One and Two-Gang Nail-On / Screw In



APBSF1GN



APBSF1G



FBSF1G



FBSF2G



Part No.	Cubic Capacity	Description	Products Size L×W×D	Outer Box Size L×W×D(cm)	STD. CTN. QTY.
APBSF1GN	22 cu in Four V-clamps	New Work; 1-Gang; Captive Nail Mounting; Switch & Outlet Box; Horizontal.	3-3/4"×2-1/4"×3-4/5"	53.5×46×19	100
APBSF1G	22.5 cu in	New Work; 1-Gang; Switch and Outlet Box with Side Angled Screws.	-	-	-
FBSF1G	18.5 cu in	New Work; 1-Gang Device Box with Depth Adjustable.	2.24"×3.4"×3.82"	49×38.5×25	100
FBSF2G	38 cu in	New Work; 2-Gang Device Box with Depth Adjustable.	4.2"×3.4"×3.82"	55×30×33.5	60



Ceiling Box

Round Ceiling Boxes - New Work



APBR18-3



APBRG18-3



Part No.	Cubic Capacity	Description	Products Size L×W×D	Outer Box Size L×W×D(cm)	STD. CTN. QTY.
APBR18-3	18 cu in Four Integral Clamps	New Work; 18 cu in; Nail-on; Ceiling Box with Wire Clamps.	3 Dia×2-3/4"	45.5×32×36	50
APBRG18-3	18 cu in Four Integral Clamps	New Work; 18 cu in; Nail-on; Ceiling Box with Wire Clamps; Ground Lug and Screw Attached.	3 Dia×2-3/4"	45.5×32×36	50

Round Ceiling Boxes - New Work



APB05N



APB05GN



APB620L



Part No.	Cubic Capacity	Description	Products Size L×W×D	Outer Box Size L×W×D(cm)	STD. CTN. QTY.
APB05N	20 cu in Six Integral Clamps	New Work; 20 cu in; Nail-on; Ceiling Box with Wire Clamps.	4 Dia×2-1/4"	51×46×24	60
APB05GN	20 cu in Six Integral Clamps	New Work; 20 cu in; Nail-on; Ceiling Box with Wire Clamps; Ground Lug and Screw Attached.	4 Dia×2-1/4"	51×46×24	60
APB620L	20 cu in Six Integral Clamps	New Work; 20 cu in; Ceiling Box with Wire Clamps and L-Bracket.	4 Dia×2-1/4"	-	-



Ceiling Box

Round Ceiling Boxes - New Work



APB525A



APB525AG



Part No.	Cubic Capacity	Description	Products Size L×W×D	Outer Box Size L×W×D(cm)	STD. CTN. QTY.
APB525A	25 cu in Six Integral Clamps	New Work; 25 cu in; Nail-on; Ceiling Box with Wire Clamps.	4 Dia×3.0"	-	-
APB525AG	25 cu in Six Integral Clamps	New Work; 25 cu in; Nail-on; Ceiling Box with Wire Clamps; Ground Lug and Screw Attached.	4 Dia×3.0"	-	-

Ceiling Boxes with Bar Hanger



APB06N



APB06NL



APB06GNL



Part No.	Cubic Capacity	Description	Products Size L×W×D	Outer Box Size L×W×D(cm)	STD. CTN. QTY.
APB06N	20 cu in Six Integral Clamps	New Work; 20 cu in; Ceiling Box with 14.25"-22.5" Adjustable Bar Hanger and Wire Clamps.	4 Dia×2-1/4"	43.5×37×36.5	55
APB06NL	20 cu in Six Integral Clamps	New Work; 20 cu in; Ceiling Box with 16"-24" Adjustable Bar Hanger and Wire Clamps.	4 Dia×2-1/4"	56.5×38.5×38	75
APB06GNL	20 cu in Six Integral Clamps	New Work; 20 cu in; Ceiling Box with 16"-24" Adjustable Bar Hanger and Wire Clamps; Ground Lug and Screw Attached.	4 Dia×2-1/4"	56.5×38.5×38	75



Ceiling Box

Ceiling Boxes - New Work



CFB-1



CFB-2



PANCAK



Part No.	Cubic Capacity	Description	Products Size LxWxD	Outer Box Size LxWxD(cm)	STD. CTN. QTY.
CFB-1	13.4 cu in	New Work; 4" Ceiling Fan Support Box; Fits All Ceiling Fans, 2 Hour Fire Rating, Supports Fixtures up to 150 lbs and fans up to 70 lbs, Non-Metallic.	4"×1/2"×4"	53.5×53.5×25	100
CFB-2	12 cu in	New Work; Non-metallic Saddle Type Ceiling Fan/fixture Box with V-clamps For Non-metallic Sheathed Cable; Lag Screws (supplied).	4 Dia×2-3/8"	-	-
PANCAK	8 cu in	New Work; Shallow Ceiling Fan Outlet Box with mounting screws; The box is rated for a 35 Lb. fan and a 50 Lb. light fixture.	4.25 Dia×1"	33.5×22.5×19.5	60

Octagon Ceiling Box - New Work



APB525BST



Part No.	Cubic Capacity	Description	Products Size LxWxD	Outer Box Size LxWxD(cm)	STD. CTN. QTY.
APB525BST	20 cu in	New Work; 20 cu in; Octagon Ceiling Box with an L-Bracket for residential and light commercial ceiling fixture applications. The 6 knockouts provide multiple wiring options.	4 Dia×2.25"	50×30.3×25.5	60



New Work Box w Brackets

One and Two-Gang Brackets



APB122BST



APB238BST



Part No.	Cubic Capacity	Description	Products Size L×W×D	Outer Box Size L×W×D(cm)	STD. CTN. QTY.
APB122BST	22 cu in	New Work; 1-Gang ENT Non-Metallic Outlet Box with Eccentric Knockouts; Number of Knockout 4, Knockout Size 1/2 Inch, 3/4 Inch, and 1 Inch.	2.1"×3.5"×3.25"	54×28.5×34.5	60
APB238BST	38 cu in	New Work; 2-Gang ENT Non-Metallic Outlet Box with Eccentric Knockouts; Number of Knockout 5, Knockout Size 1/2 Inch, 3/4 Inch, and 1 Inch.	3.85"×3.5"×3.45"	55×29×29	30

One and Two-Gang Brackets



APB108B



APB123NBS



APB118NB



APB232-B



Part No.	Cubic Capacity	Description	Products Size L×W×D	Outer Box Size L×W×D(cm)	STD. CTN. QTY.
APB108B	8 cu in	New Work; 1-Gang; Shallow; Switch and Outlet Box with Bracket.	2-3/8"×3-5/8"×1-1/4"	-	-
APB123NBS	22.5 cu in Four Integral Clamps	New Work; 1-Gang; Switch/Outlet Box with Steel Stud Bracket & Wire Clamps.	2-1/4"×3-3/4"×3-7/16"	48×33.5×41	100
APB118NB	18 cu in Four Knockouts	New Work; 1-Gang; Bracket for 3/8" to 5/8" Wallboard – Steel and Wood Stud Mounting.	2-1/4"×3-3/4"×2-15/16"	48×40×30.5	100
APB232-B	32 cu in Eight Integral Clamps	New Work; 2-Gang; Bracket for 3/8" to 5/8" Wallboard – Steel and Wood Stud Mounting.	4"×3-3/4"×3"	48×25×31	50



New Work Adjustable Box

One-Gang Horizontal Adjustable



APB121-ADJ-E



Part No.	Cubic Capacity	Description	Products Size L×W×D	Outer Box Size L×W×D(cm)	STD. CTN. QTY.
APB121-ADJ-E	21 cu in Four Knockouts	New Work; 1-Gang; Adjustable Electrical Wall Box with Horizontal Mount.	3.70"×2.30"×3.30"	51×34.5×37	100

One, Two, Three and Four-Gang Adjustable



APB121-ADJ



APB234N-ADJ



APB349-ADJ



APB468-ADJ



Part No.	Cubic Capacity	Description	Products Size L×W×D	Outer Box Size L×W×D(cm)	STD. CTN. QTY.
APB121-ADJ	21 cu in Four Knockouts	New Work; 1-Gang; Adjustable Bracket Mounting; For Use With Non-Metallic Sheathed Cable.	2.25"×3.65"×3.32"	51×34.5×37	100
APB234N-ADJ	34 cu in Six Integral Clamps	New Work; 2-Gang; Adjustable Bracket Mounting; Large 220V Knockout; For Use With Non-Metallic Sheathed Cable.	4.00"×3.65"×3.00"	51.5×36.5×32.5	60
APB349-ADJ	49 cu in Twelve Integral Clamps	New Work; 3-Gang; Adjustable Bracket Mounting; For Use With Non-Metallic Sheathed Cable.	5.90"×3.65"×3.00"	51×35.5×24.5	30
APB468-ADJ	68 cu in Sixteen Integral Clamps	New Work; 4-Gang; Adjustable Bracket Mounting; For Use With Non-Metallic Sheathed Cable.	7.72"×3.65"×3.00"	60×35.5×24.5	30



Old Work Box

One-Gang



APB108-OW



APB117-OW



APB010



APB010-20



Part No.	Cubic Capacity	Description	Products Size L×W×D	Outer Box Size L×W×D(cm)	STD. CTN. QTY.
APB108-OW	8 cu in	Old Work; 1-Gang; 8 cu in Flanged Shallow Box; Mounting Ears.	2-3/8"×3-5/8"×1-1/4"	44.5×30.5×32	200
APB117-OW	17 cu in	Old Work; 1-Gang; 17 cu in Shallow Box with Side Compartment; Mounting Ears and Swing Clamps.	4.07"×3.64"×2"	55×35×28	90
APB010	14 cu in Four Integral Clamps	Old Work; 1-Gang; Mounting Ears and Swing Clamps; For Use With Non-Metallic Sheathed Cable; Suitable For Masonry Walls.	2-1/4"×4-3/10"×2-3/4"	47×29.5×30	100
APB010-20	20 cu in Four Integral Clamps	Deep; Old Work; 1-Gang; Mounting Ears and Swing Clamps; For Use With Non-Metallic Sheathed Cable; Suitable For Masonry Walls.	2-1/4"×4-3/10"×3-1/4"	47×29.5×19.5	50

Two, Three and Four-Gang Old Work



APB020



APB030



APB030D



APB040



Part No.	Cubic Capacity	Description	Products Size L×W×D	Outer Box Size L×W×D(cm)	STD. CTN. QTY.
APB020	25 cu in Six Integral Clamps	Old Work; 2-Gang; Mounting Ears and Two Swing Clamps; For Use With Non-Metallic Sheathed Cable; Suitable For Masonry Walls.	4"×3-3/4"×2-3/4"	46.5×41×37	100
APB030	38 cu in Ten Integral Clamps	Old Work; 3-Gang; Mounting Ears and Two Swing Clamps; For Use With Non-Metallic Sheathed Cable; Suitable For Masonry Walls.	5-7/10"×3-3/4"×2-3/4"	47×45×30	60
APB030D	55 cu in Six Integral Clamps	Deep; Old Work; 3-Gang; Mounting Ears and Two Swing Clamps; For Use With Non-Metallic Sheathed Cable; Suitable For Masonry Walls.	5.72"×2.79"×3.69"	47×40×28.5	36
APB040	69.8 cu in Twelve Integral Clamps	Old Work; 4-Gang; Mounting Ears and Two Swing Clamps; For Use With Non-Metallic Sheathed Cable; Suitable For Masonry Walls.	7-7/10"×3-3/4"×3-1/2"	47×40×28.5	30



Old Work Box

Round Ceiling Boxes - Old Work



APB050



APB050G



Part No.	Cubic Capacity	Description	Products Size L×W×D	Outer Box Size L×W×D(cm)	STD. CTN. QTY.
APB050	18 cu in Four Integral Clamps	Old Work; 18 cu in; Swing Clamps; Ceiling Box with Wire Clamps.	4-1/4 Dia×2-5/8"	48.5×48.5×29.5	100
APB050G	18 cu in Four Integral Clamps	Old Work; 18 cu in; Swing Clamps; Ceiling Box with Wire Clamps; Ground Lug and Screw Attached.	4-1/4 Dia×2-5/8"	48.5×48.5×29.5	100



Dual Voltage Box / Low Voltage Bracket

Dual Voltage Box/Bracket



PSB120LV



APB18-4DV



Intertek
5010519
2-HR-W-C



Part No.	Cubic Capacity	Description	Products Size L×W×D	Outer Box Size L×W×D(cm)	STD. CTN. QTY.
PSB120LV	20.5 cu in	New Work; 2-Gang; Angled side nails; Dual Voltage Box/Bracket; 3/4" dia. Resi-Ring for Resi-Gard fitting.	4.04"×3.69"×3.67"	54×34×29.5	100
APB18-4DV	18 cu in	Old Work; 2-Gang; #4 Swing Brackets; V-clamps, additional tabs for cable mounts.	4"×3-3/4"×3"	54×37.5×24	100

Low Voltage Brackets



APB1GN



APB2GN



APB3GN



Part No.	Cubic Capacity	Description	Products Size L×W×D	Outer Box Size L×W×D(cm)	STD. CTN. QTY.
APB1GN	N/A	New Work; 1-Gang; Low Voltage Bracket With Nail; 3/4", 1", 1-1/4" Resi-Rings. Captive Angled Nails or Brackets for Vertical or Horizontal Mounting.	2.32"×3.73"×3.15"	54×37.5×24	100
APB2GN	N/A	New Work; 2-Gang; Low Voltage Bracket With Nail; 3/4", 1", 1-1/4" Resi-Rings. Captive Angled Nails or Bracket Mounting.	4.07"×3.77"×3.15"		
APB3GN	44 cu in	New Work; 3-Gang; Low Voltage Bracket With Nail; Captive Angled Nails or Bracket Mounting.	5.81"×3.69"×1.50"		



Low Voltage Ring

Low Voltage Adjustable Brackets



APB121ADJLV



APB234ADJLV



Part No.	Cubic Capacity	Description	Products Size L×W×D	Outer Box Size L×W×D(cm)	STD. CTN. QTY.
APB121ADJLV	N/A	New Work; 1-Gang; Low Voltage Adjustable Bracket.	3.88"×3.56"×1.69"	59×53×20	100
APB234ADJLV	N/A	New Work; 2-Gang; Low Voltage Adjustable Bracket.	5.63"×3.56"×1.69"	-	-

Low Voltage Nail-On



PLVP1G



PLVP2G



Part No.	Cubic Capacity	Description	Products Size L×W×D	Outer Box Size L×W×D(cm)	STD. CTN. QTY.
PLVP1G	N/A	New Work; 1-Gang; Low Voltage Nail-On Mounting Bracket.	3.14"×5.34"×1.61"	54×37.5×24	100
PLVP2G	N/A	New Work; 2-Gang; Low Voltage Nail-On Mounting Bracket.	4.17"×5.49"×1.5"	52.5×46.5×25.5	60



Old Work Bracket/ Box Extender

Old Work Brackets



APB1GOW



APB2GOW



Part No.	Cubic Capacity	Description	Products Size L×W×D	Outer Box Size L×W×D(cm)	STD. CTN. QTY.
APB1GOW	N/A	Old Work; 1-Gang; Low Voltage Bracket; Swing Bracket.	2.52"×4.32"×1.66"	54×37.5×24	100
APB2GOW	N/A	Old Work; 2-Gang; Low Voltage Bracket; Swing Bracket.	4.28"×4.28"×1.66"	54×37.5×24	100

Box Extender



APB1GOWE



Part No.	Cubic Capacity	Description	Products Size L×W×D	Outer Box Size L×W×D(cm)	STD. CTN. QTY.
APB1GOWE	N/A	1-Gang Box Extender.	2-1/4"×3-1/4"	-	-



Handy Box and Covers

Features

- Flexible, can be used for many applications
- Thermoplastic construction that will not rust or conduct electricity
- Built in cable clamps to hold wire firmly in place
- Six knockouts for easier wiring
- Four cover styles – blank, toggle switch, duplex receptacle, and GFCI
- ETL Listed (5010519) and two hour fire rating

Handy Box



PHB -1-50



Part No.	Cubic Capacity	Description	Products Size L×W×D	Outer Box Size L×W×D(cm)	STD. CTN. QTY.
PHB-1-50	12 cu in	1-Gang; Non-Metallic Handy Box.	1-7/8"×4"×2-1/8"	-	-

Covers



PHBC -B



PHBC -TS



PHBC -DR



PHBC -GFI



Part No.	Cubic Capacity	Description	Products Size L×W×D	Outer Box Size L×W×D(cm)	STD. CTN. QTY.
PHBC -B	-	1-Gang; Handy Box Blank Cover	2.36"×4.28"×0.25"	-	-
PHBC -TS	-	1-Gang; Handy Box Toggle Switch Cover	2.36"×4.28"×0.25"	-	-
PHBC -DR	-	1-Gang; Handy Box Duplex Receptacle Cover	2.36"×4.28"×0.25"	-	-
PHBC-GFI	-	1-Gang; Handy Box GFCI Cover	2.36"×4.28"×0.25"	-	-



Ring / Covers

One and Two-Gang



PSC410



PSC420



PSC400



Part No.	Cubic Capacity	Description	Products Size LxWxD	Outer Box Size LxWxD(cm)	STD. CTN. QTY.
One-Gang Electrical Box Cover Risers					
PSC410	3.5 cu in	1/2" Rise	4"x4"x0.500"	-	-
PSC411	4.2 cu in	5/8" Rise	4"x4"x0.625"	43x21.5x10.2	50
PSC412	5.0 cu in	3/4" Rise	4"x4"x0.750"	-	-
PSC413	6.6 cu in	1" Rise	4"x4"x1.000"	-	-
PSC414	8.1 cu in	1-1/4" Rise	4"x4"x1.250"	-	-
Two-Gang Electrical Box Cover Risers					
PSC420	6.1 cu in	1/2" Rise	4"x4"x0.500"	-	-
PSC421	7.4 cu in	5/8" Rise	4"x4"x0.625"	-	-
PSC422	8.8 cu in	3/4" Rise	4"x4"x0.850"	-	-
Two-Gang 4" Square Blank Cover					
PSC400	-	Blank	4"x4"x0.1"	-	-

Round



PRC410



PRC4KO



PRC400



Staco90-069



Part No.	Cubic Capacity	Description	Products Size LxWxD	Outer Box Size LxWxD(cm)	STD. CTN. QTY.
Round Plaster Rings					
PRC410	3.2 cu in	1/2" Rise	4"x4"x0.500"	41x41x12	100
PRC411	4.0 cu in	5/8" Rise	4"x4"x0.625"	-	-
Round Blank Covers					
PRC4KO	-	Blank with 1/2" Knockout	4"x4"x0.1"	-	-
PRC400	-	Blank	4"x4"x0.1"	-	-
Staco90-069	-	Ceiling Box Cover	5.15"x5.15"x0.3"	29x29x22.5	100



Fiberglass (BMC) Box

One, Two, Three and Four-Gang



FG01N



FG02N



FG03N



FG04N



Part No.	Cubic Capacity	Description	Products Size L×W×D	Outer Box Size L×W×D(cm)	STD. CTN. QTY.
FG01N	22.5 cu in	1-Gang Off-White Fiberglass New Work Deep Switch/Outlet Interior Electrical Box.	2-1/4"×3-27/32"×3-9/16"	48.5×31.5×25.5	60
FG02N	37 cu in	2-Gang Off-White Fiberglass New Work Deep Switch/Outlet Interior Electrical Box.	4"×3-3/4"×3-7/16"	51×45.5×32.7	60
FG03N	56.5 cu in	3-Gang Off-White Fiberglass New Work Deep Switch/Outlet Interior Electrical Box.	5-11/16"×3-3/4"×3-9/16"	46×28×47.5	30
FG04N	75 cu in	4-Gang Off-White Fiberglass New Work Deep Switch/Outlet Interior Electrical Box.	7-1/2"×3-3/4"×3-9/16"	63.5×40.2×29.5	30

Ceiling Boxes



FG05N



FG06N



Part No.	Cubic Capacity	Description	Products Size L×W×D	Outer Box Size L×W×D(cm)	STD. CTN. QTY.
FG05N	22.5 cu in	Round Fiberglass Ceiling Fixture Outlet Box.	4 Dia×2-7/16"	54.5×33×32.5	60
FG06N	22.5 cu in	Round Fiberglass Ceiling Fixture Outlet Box with 16"- 24" Adjustable Bar Hanger.	4 Dia×2-7/16"	41.5×39×40	50



OUTLET BOX EXTENDER

One, Two, Three and Four-Gang



EXR-01



EXR-02



EXR-03

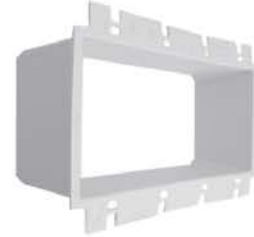

EXR-04



Part No.	Description	Products Size L×W×D	Outer Box Size L×W×D(cm)	STD. CTN. QTY.
EXR-01	Single Gang Electrical Outlet Box Extender	2.43"×4.28"×1.85"	64×45×26.5	400
EXR-02	Two Gang Electrical Outlet Box Extender	4.32"×4.28"×1.85"	64×45×26.5	200
EXR-03	Three Gang Electrical Outlet Box Extender	6.13"×4.28"×1.85"	64×43×37	200
EXR-04	Four Gang Electrical Outlet Box Extender	7.80"×4.28"×1.85"	64×45×22	100

Ceiling Box



EXR-05



Part No.	Description	Products Size L×W×D	Outer Box Size L×W×D(cm)	STD. CTN. QTY.
EXR-05	Ceiling Box Extender/Set Back Ceilings	4.92"×4.92"×1.50"	64×43×38	200



GFCI RECEPTACLE



15 AMP DUAL USB TYPE A & C RECEPTACLE BAA-015 (TAMPER RESISTANT)

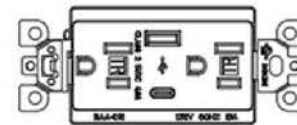
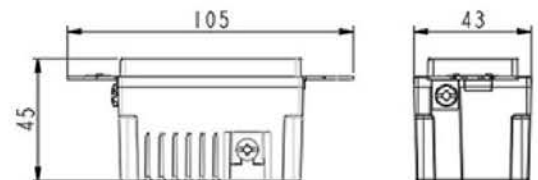

DESCRIPTION

1. Smart System: Built-in smart chip recognizes the individual device's charging requirement to optimize the charge.
2. Safety: Fireproof housing and high-quality components for long service life.
3. Unique 2 USB Ports: Charges two USB devices without adapters.
4. Tamper resistant(TR): TR design increases the electrical safety level by preventing the attempting to insert objects in to the outlet or open the plate.

COMMON TECHNICAL DATA

Size	105*43*45mm
Color	Cover: White (Customizable) Base: Black (Customizable)
Enclosure	PC
Terminal	Copper Alloy Acid Pickling
Mounting Yoke	Zinc Plated Steel
Weight	111g
Certification	cULus
Standards	UL 498&CSA C22.2 No. 42-10
Receptacle Rating	15A/125Vac/60hZ
USB Rating	5 VDC/4.8A
Dielectric Voltage Withstand	1.25KV/1min
Flame Class	UL-94 V2
Wire	12-14 AWG

CERTIFICATION





15 AMP DUAL USB RECEPTACLE

BAA-023 (TAMPER RESISTANT)

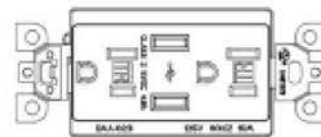
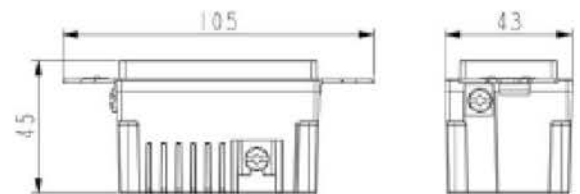

DESCRIPTION

- Smart System: Built-in smart chip recognizes the individual device's charging requirement to optimize the charge.
- Safety: Fireproof housing and high-quality components for long service life.
- Unique 2 USB Ports: Charges two USB devices without adapters.
- Tamper resistant(TR):TR design increases the electrical safety level by preventing the attempting to insert objects in to the outlet or open the plate.

COMMON TECHNICAL DATA

Size	105*43*45mm
Color	Cover: White (Customizable) Base: Black (Customizable)
Enclosure	PC
Terminal	Copper Alloy Acid Pickling
Mounting Yoke	Zinc Plated Steel
Weight	111g
Standards	UL 498&CSA C22.2 No. 42-10
Receptacle Rating	15A/125Vac/60hZ
USB Rating	5 VDC/4.8A
Dielectric Voltage	1.25KV/1min
Flame Class	UL-94 V2
Wire	12-14 AWG

CERTIFICATION





15 AMP GFCI RECEPTACLE

YGB-094WR (WEATHER RESISTANT, TAMPER RESISTANT)



DESCRIPTION

- Constructed with premium high-impact resistant thermoplastic materials and rational structure design, ensures superior strength and durability.
- Two Indicator Light provides simple, intuitive feedback on power and protection status. If the indicator (LED) glows green, you have installed the GFCI receptacle correctly and it is working properly. The GFCI outlet automatically conducts a Self-Test (the red light will blink once) every 40 seconds to ensure the GFCI is continually working. When the GFCI receptacle reaches the end of its' life the red indicator will turn on, it reminds you to replace the outlet in time.
- Weather Resistant - enhanced corrosion resistant components to withstand more moist or humid location.
- Tamper resistant(TR) -- TR design increases the electrical safety level by preventing the attempting to insert objects in to the outlet or open the plate.
- Provides continuous ground fault protection -- detects and trips on actual ground fault even when self-test is being conducted.



COMMON TECHNICAL DATA

Size	105*42.8*40.7mm
Color	Cover: White (Customizable) Base: Black (Customizable)
Enclosure	PC
Terminal	Copper Alloy Acid Pickling
Mounting Yoke	Zinc Plated Steel
Weight	123g
Standards	UL498/UL943/CSA C22.2 No.144.1
Receptacle Rating	15A/125Vac
Dielectric Voltage	1500V (AC)
Mechanical Life	6000 times
Flame Class	UL-94 V2
Trip Threshold	5mA
Trip Time	<25mS
Insertion Force	1<178N
Release Force	<67N
Retention Force	>13N
Wires	12-14AWG

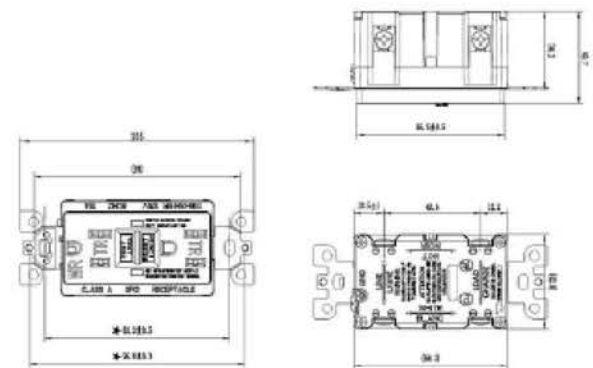

CERTIFICATION





15 AMP GFCI RECEPTACLE

YGB-094 (TAMPER RESISTANT)

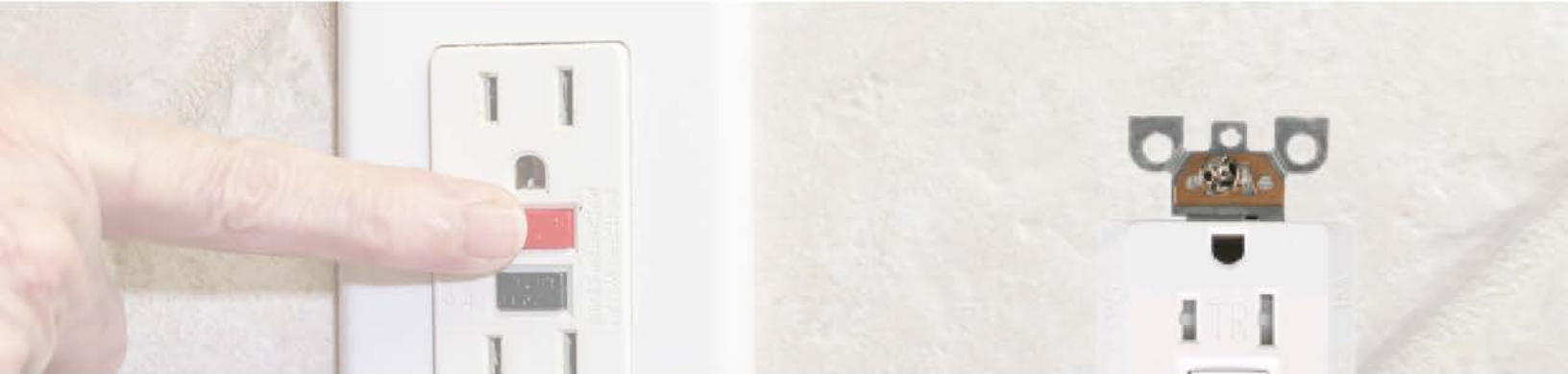

DESCRIPTION

- Constructed with premium high-impact resistant thermoplastic materials and rational structure design, ensures superior strength and durability.
- Two Indicator Light provides simple, intuitive feedback on power and protection status. If the indicator (LED) glows green, you have installed the GFCI receptacle correctly and it is working properly. The GFCI outlet automatically conducts a Self-Test (the red light will blink once) every 40 seconds to ensure the GFCI is continually working. When the GFCI receptacle reaches the end of its' life the red indicator will turn on, it reminds you to replace the outlet in time.
- Weather Resistant - enhanced corrosion resistant components to withstand more moist or humid location.
- Tamper resistant(TR) -- TR design increases the electrical safety level by preventing the attempting to insert objects in to the outlet or open the plate.
- Provides continuous ground fault protection -- detects and trips on actual ground fault even when self-test is being conducted.

COMMON TECHNICAL DATA

Size	105*42.8*40.7mm
Color	Cover: White (Customizable) Base: Black (Customizable)
Enclosure	PC
Terminal	Copper Alloy Acid Pickling
Mounting Yoke	Zinc Plated Steel
Weight	123g
Standards	UL498/UL943/CSA C22.2 No.144.1
Receptacle Rating	15A/125Vac
Dielectric Voltage	1500V (AC)
Mechanical Life	6000 times
Flame Class	UL-94 V2
Trip Threshold	5mA
Trip Time	<25mS
Insertion Force	1<178N
Release Force	<67N
Retention Force	>13N
Wires	12-14AWG

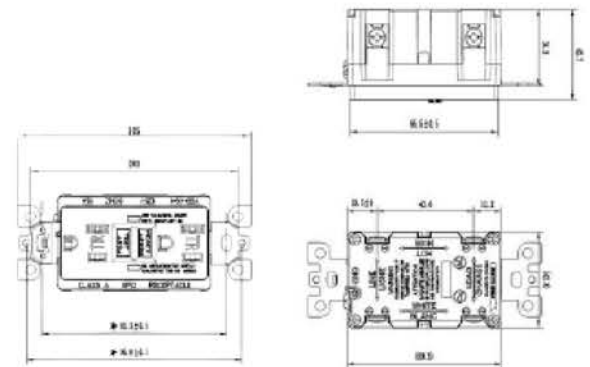

CERTIFICATION





20 AMP GFCI RECEPTACLE

YGB-095WR (WEATHER RESISTANT, TAMPER RESISTANT)

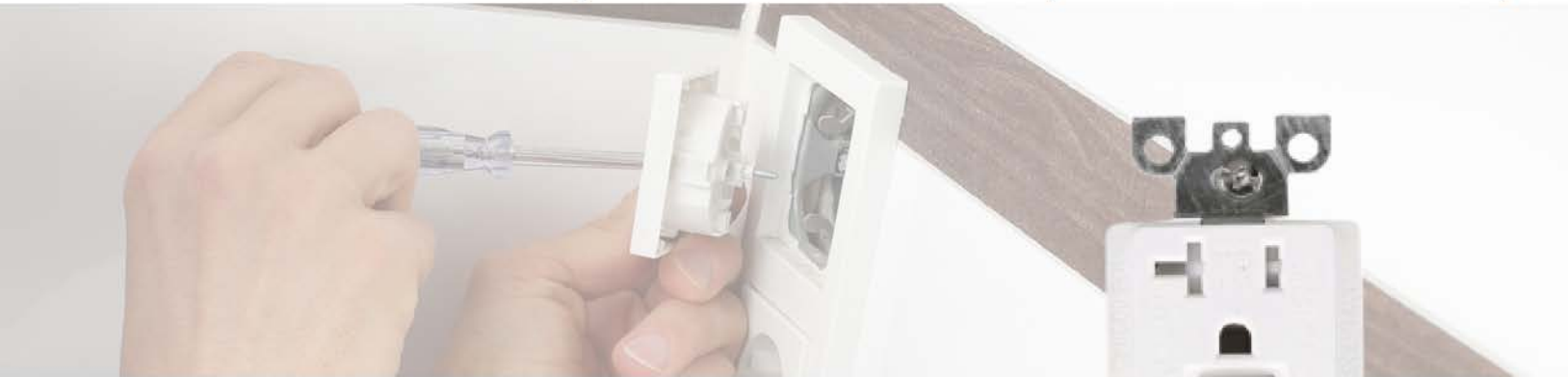

DESCRIPTION

- Constructed with premium high-impact resistant thermoplastic materials and rational structure design, ensures superior strength and durability.
- Two Indicator Light provides simple, intuitive feedback on power and protection status. If the indicator (LED) glows green, you have installed the GFCI receptacle correctly and it is working properly. The GFCI outlet automatically conducts a Self-Test (the red light will blink once) every 40 seconds to ensure the GFCI is continually working. When the GFCI receptacle reaches the end of its' life the red indicator will turn on, it reminds you to replace the outlet in time.
- Weather Resistant - enhanced corrosion resistant components to withstand more moist or humid location.
- Tamper resistant(TR) -- TR design increases the electrical safety level by preventing the attempting to insert objects in to the outlet or open the plate.
- Provides continuous ground fault protection -- detects and trips on actual ground fault even when self-test is being conducted.

COMMON TECHNICAL DATA

Size	105*42.8*40.7mm
Color	Cover: White (Customizable) Base: Black (Customizable)
Enclosure	PC
Terminal	Copper Alloy Acid Pickling
Mounting Yoke	Zinc Plated Steel
Weight	123g
Standards	UL498/UL943/CSA C22.2 No.144.1
Receptacle Rating	20A/125Vac
Dielectric Voltage	1500V (AC)
Mechanical Life	6000 times
Flame Class	UL-94 V2
Trip Threshold	5mA
Trip Time	<25mS
Insertion Force	<178N
Release Force	<67N
Retention Force	>13N
Wires	12-14AWG

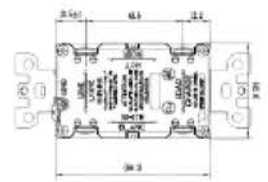
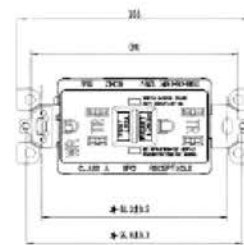
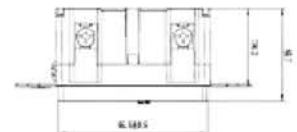

CERTIFICATION



WEATHERPROOF BOX / COVER



WEATHERPROOF BOXES - SINGLE GANG (2 HOLES) - ALUMINUM



CATALOG NUMBER	TRADE SIZE	COLOR	INNER CARTON	MASTER CARTON
65031	1/2"	GRAY/WHITE/BRONZE	-	50
65032	3/4"	GRAY/WHITE/BRONZE	-	50
	1"		-	50



CAT#	A	B	C
65031	4.606	2.815	2.028
65032	4.606	2.815	2.028



WEATHERPROOF BOXES - SINGLE GANG (4 HOLES) - ALUMINUM

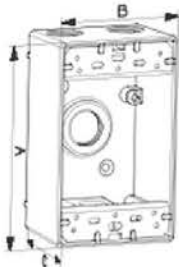

CATALOG NUMBER	TRADE SIZE	COLOR	INNER CARTON	MASTER CARTON
65041	1/2"	GRAY/WHITE/BRONZE	-	50
65042	3/4"	GRAY/WHITE/BRONZE	-	50



CAT#	A	B	C
65041	4.606	2.815	2.028
65042	4.606	2.815	2.028



WEATHERPROOF BOXES - SINGLE GANG (5 HOLES) - ALUMINUM



CATALOG NUMBER	TRADE SIZE	COLOR	INNER CARTON	MASTER CARTON
65051	1/2"	GRAY/WHITE/BRONZE	-	50
65052	3/4"	GRAY/WHITE/BRONZE	-	50



CAT#	A	B	C
65051	4.606	2.815	2.028
65052	4.606	2.815	2.028



GRAY IS STANDARD COLOR

WEATHERPROOF BOXES - DOUBLE GANG (3 HOLES) - ALUMINUM

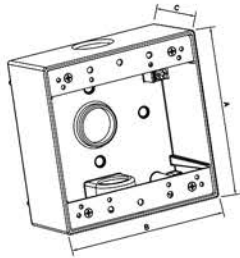

CATALOG NUMBER	TRADE SIZE	COLOR	INNER CARTON	MASTER CARTON
65131	1/2"	GRAY/WHITE/BRONZE	-	15
65132	3/4"	GRAY/WHITE/BRONZE	-	15



CAT#	A	B	C
65131	4.539	4.579	2.098
65132	4.539	4.579	2.098

WEATHERPROOF BOXES - DOUBLE GANG (4 HOLES) - ALUMINUM

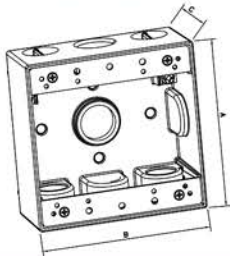

CATALOG NUMBER	TRADE SIZE	COLOR	INNER CARTON	MASTER CARTON
65141	1/2"	GRAY/WHITE/BRONZE	-	15
65142	3/4"	GRAY/WHITE/BRONZE	-	15



CAT#	A	B	C
65141	4.539	4.579	2.098
65142	4.539	4.579	2.098

WEATHERPROOF BOXES - DOUBLE GANG (5 HOLES) - ALUMINUM

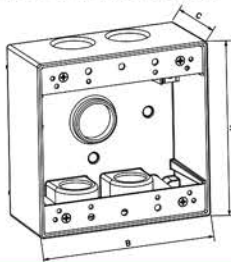

CATALOG NUMBER	TRADE SIZE	COLOR	INNER CARTON	MASTER CARTON
65151	1/2"	GRAY/WHITE/BRONZE	-	15
65152	3/4"	GRAY/WHITE/BRONZE	-	15



CAT#	A	B	C
65151	4.539	4.579	2.098
65152	4.539	4.579	2.098

GRAY IS STANDARD COLOR

WEATHERPROOF BOXES - DOUBLE GANG (4 " ROUND BOX) - ALUMINUM



CATALOG NUMBER	TRADE SIZE	COLOR	INNER CARTON	MASTER CARTON
65241	1/2"	GRAY/WHITE/BRONZE	-	50

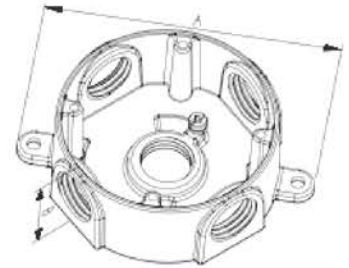

CAT#	A	B
65241	5.551	1.630

WEATHERPROOF SINGLE GANG DEVICE MOUNT COVER - BLANK - ALUMINUM/STEEL

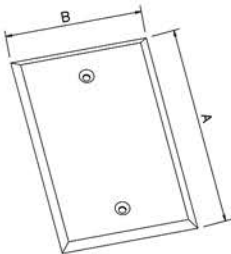

CAT#	A	B
76201	4.736	2.953

CATALOG NUMBER	TRADE SIZE	INNER CARTON	MASTER CARTON
76201	-	-	200



TWO GANG WEATHERPROOF DEVICE MOUNT COVER BLANK - ALUMINUM/STEEL

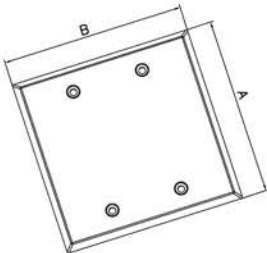

CAT#	A	B
76221	4.657	4.657

CATALOG NUMBER	TRADE SIZE	INNER CARTON	MASTER CARTON
76221	-	-	200



4" ROUND CEILING CLOSURE PLATE - ALUMINUM/STEEL

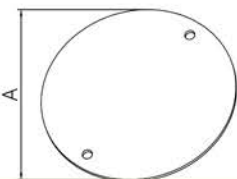

CAT#	A
76101	4.173

CATALOG NUMBER	TRADE SIZE	INNER CARTON	MASTER CARTON
76101	-	-	200



ONE GANG COVER GFCI HORIZONTAL INCLUDE GASKET, SCREWS - ZINC

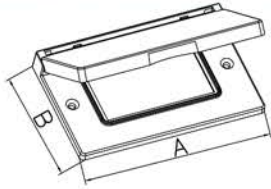

CATALOG NUMBER	TRADE SIZE	INNER CARTON	MASTER CARTON
65822-GH	-	-	50

NEW



UL US
E360998

CAT#	A	B
65822-GH	4.560	2.830

ONE GANG COVER GFCI-VERTICAL INCLUDE GASKET, SCREWS - ZINC

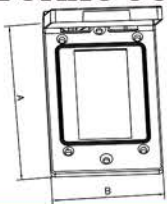

CATALOG NUMBER	TRADE SIZE	INNER CARTON	MASTER CARTON
65829-GV	-	-	50

NEW



UL US
E360998

CAT#	A	B
65829-GV	4.560	2.830

ONE GANG COVER DUPLEX/COMB, DEVICE - HORIZONTAL INCLUDE GASKET, SCREWS - ZINC

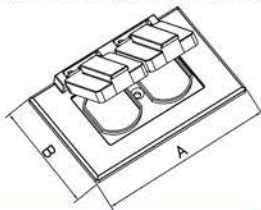

CATALOG NUMBER	TRADE SIZE	INNER CARTON	MASTER CARTON
65821-DH	-	-	50

NEW



UL US
E360998

CAT#	A	B
65821-DH	4.560	2.830

TWO GANG COVER TWO DUPLEX INCLUDE GASKET, SCREW - ZINC

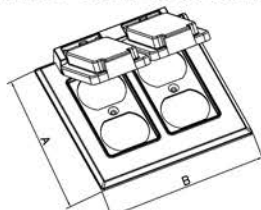

CATALOG NUMBER	TRADE SIZE	INNER CARTON	MASTER CARTON
65836-2D	-	-	50

NEW



UL US
E360998

CAT#	A	B
65836-2D	4.500	4.530

TWO GANG COVER TWO GFCI INCLUDE GASKET, SCREWS - ZINC

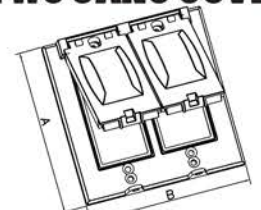

CATALOG NUMBER	TRADE SIZE	INNER CARTON	MASTER CARTON
65837-2G	-	-	50

NEW



UL US
E360998

CAT#	A	B
65837-2G	4.530	4.530

CONDUIT BODIES



CONDUIT BODIES FOR E.M.T. SET SCREW TYPE - ALUMINUM

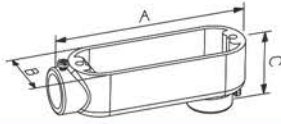

CAT#	A	B	C
LB-50AE	4.359	1.330	2.060
LB-75AE	4.972	1.552	2.370
LB-100AE	5.819	1.747	2.630
LB-125AE	7.795	2.491	3.500
LB-150AE	7.807	2.491	3.750
LB-200AE	9.850	3.123	4.310
LB-250AE	12.673	4.444	4.450
LB-300AE	12.583	4.459	5.800
LB-400AE	15.661	5.590	5.800

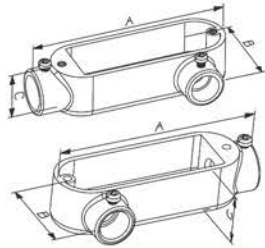

CAT#	A	B	C
LL/LR-50AE	4.359	2.015	1.412
LL/LR-75AE	4.972	2.299	1.655
LL/LR-100AE	5.819	2.427	1.894
LL/LR-125AE	7.795	3.391	2.685
LL/LR-150AE	7.807	3.412	2.685
LL/LR-200AE	9.850	4.082	3.425
LL/LR-250AE	12.673	5.878	3.984
LL/LR-300AE	12.583	5.898	4.448
LL/LR-400AE	15.661	7.681	5.559

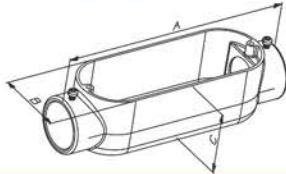

CAT#	A	B	C
C-50AE	4.825	1.330	1.412
C-75AE	5.646	1.552	1.655
C-100AE	6.467	1.747	1.894
C-125AE	8.268	2.491	2.685
C-150AE	8.268	2.491	2.685
C-200AE	10.232	3.123	3.425
C-250AE	13.102	4.444	3.984
C-300AE	13.067	4.459	4.448
C-400AE	16.236	5.590	5.559

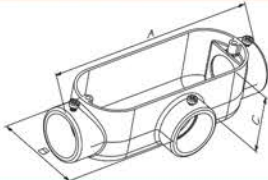

CAT#	A	B	C
T-50AE	4.825	2.089	1.412
T-75AE	5.646	2.241	1.655
T-100AE	6.467	2.522	1.894
T-125AE	8.268	3.450	2.685
T-150AE	8.268	3.460	2.685
T-200AE	10.232	4.089	3.425
T-250AE	13.102	5.850	3.984
T-300AE	13.067	5.850	4.448
T-400AE	16.236	7.648	5.559

CATALOG NUMBER	TRADE SIZE	INNER CARTON	MASTER CARTON
LB-50AE	1/2"	-	100
LB-75AE	3/4"	-	100
LB-100AE	1"	-	50
LB-125AE	1-1/4"	-	25
LB-150AE	1-1/2"	-	25
LB-200AE	2"	-	10
LB-250AE	2-1/2"	-	6
LB-300AE	3"	-	6
LB-400AE	4"	-	2

CATALOG NUMBER	TRADE SIZE	INNER CARTON	MASTER CARTON
LL-50AE	1/2"	-	100
LL-75AE	3/4"	-	100
LL-100AE	1"	-	50
LL-125AE	1-1/4"	-	25
LL-150AE	1-1/2"	-	20
LL-200AE	2"	-	10
LL-250AE	2-1/2"	-	6
LL-300AE	3"	-	6
LL-400AE	4"	-	2

CATALOG NUMBER	TRADE SIZE	INNER CARTON	MASTER CARTON
LR-50AE	1/2"	-	100
LR-75AE	3/4"	-	100
LR-100AE	1"	-	50
LR-125AE	1-1/4"	-	25
LR-150AE	1-1/2"	-	20
LR-200AE	2"	-	10
LR-250AE	2-1/2"	-	6
LR-300AE	3"	-	6
LR-400AE	4"	-	2

CATALOG NUMBER	TRADE SIZE	INNER CARTON	MASTER CARTON
C-50AECG	1/2"	-	100
C-75AECG	3/4"	-	100
C-100AECG	1"	-	50
C-125AECG	1-1/4"	-	25
C-150AECG	1-1/2"	-	20
C-200AECG	2"	-	10
C-250AECG	2-1/2"	-	6
C-300AECG	3"	-	6
C-400AECG	4"	-	2

CATALOG NUMBER	TRADE SIZE	INNER CARTON	MASTER CARTON
T-50AE	1/2"	-	100
T-75AE	3/4"	-	100
T-100AE	1"	-	50
T-125AE	1-1/4"	-	25
T-150AE	1-1/2"	-	10
T-200AE	2"	-	10
T-250AE	2-1/2"	-	6
T-300AE	3"	-	6
T-400AE	4"	-	2



 US
E360998



 US
E360998



 US
E360998



 US
E360998



 US
E360998

CONDUIT BODIES FOR E.M.T. SET SCREW TYPE WITH COVER & GASKET - ALUMINUM



CATALOG NUMBER	TRADE SIZE	INNER CARTON	MASTER CARTON
LB-50AECG	1/2"	-	100
LB-75AECG	3/4"	-	100
LB-100AECG	1"	-	50
LB-125AECG	1-1/4"	-	20
LB-150AECG	1-1/2"	-	20
LB-200AECG	2"	-	10
LB-250AECG	2-1/2"	-	6
LB-300AECG	3"	-	6
LB-400AECG	4"	-	2



CATALOG NUMBER	TRADE SIZE	INNER CARTON	MASTER CARTON
LL-50AECG	1/2"	-	100
LL-75AECG	3/4"	-	100
LL-100AECG	1"	-	50
LL-125AECG	1-1/4"	-	20
LL-150AECG	1-1/2"	-	20
LL-200AECG	2"	-	10
LL-250AECG	2-1/2"	-	6
LL-300AECG	3"	-	6
LL-400AECG	4"	-	2



CATALOG NUMBER	TRADE SIZE	INNER CARTON	MASTER CARTON
LR-50AECG	1/2"	-	100
LR-75AECG	3/4"	-	100
LR-100AECG	1"	-	50
LR-125AECG	1-1/4"	-	20
LR-150AECG	1-1/2"	-	20
LR-200AECG	2"	-	10
LR-250AECG	2-1/2"	-	6
LR-300AECG	3"	-	6
LR-400AECG	4"	-	2



CATALOG NUMBER	TRADE SIZE	INNER CARTON	MASTER CARTON
C-50AECG	1/2"	-	100
C-75AECG	3/4"	-	100
C-100AECG	1"	-	50
C-125AECG	1-1/4"	-	20
C-150AECG	1-1/2"	-	20
C-200AECG	2"	-	10
C-250AECG	2-1/2"	-	6
C-300AECG	3"	-	6
C-400AECG	4"	-	2



CATALOG NUMBER	TRADE SIZE	INNER CARTON	MASTER CARTON
T-50AECG	1/2"	-	100
T-75AECG	3/4"	-	100
T-100AECG	1"	-	50
T-125AECG	1-1/4"	-	20
T-150AECG	1-1/2"	-	20
T-200AECG	2"	-	10

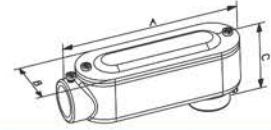

CAT#	A	B	C
LB-50AECG	4.359	1.330	2.150
LB-75AECG	4.972	1.552	2.430
LB-100AECG	5.819	1.747	2.765
LB-125AECG	7.795	2.491	3.665
LB-150AECG	7.807	2.491	3.665
LB-200AECG	9.850	3.123	4.275
LB-250AECG	12.673	4.444	5.437
LB-300AECG	12.583	4.459	5.675
LB-400AECG	15.661	5.590	6.922

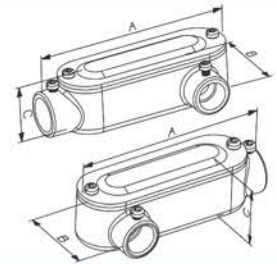

CAT#	A	B	C
LL/LR-50AECG	4.359	2.015	1.687
LL/LR-75AECG	4.972	2.229	1.900
LL/LR-100AECG	5.819	2.427	2.193
LL/LR-125AECG	7.795	3.391	3.008
LL/LR-150AECG	7.807	3.412	3.008
LL/LR-200AECG	9.850	4.082	3.736
LL/LR-250AECG	12.673	5.878	4.437
LL/LR-300AECG	12.583	5.898	4.933
LL/LR-400AECG	15.661	7.681	5.976

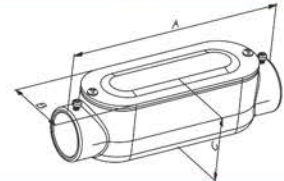

CAT#	A	B	C
C-50AECG	4.825	1.330	1.687
C-75AECG	5.646	1.552	1.900
C-100AECG	6.467	1.747	2.193
C-125AECG	8.268	2.491	3.008
C-150AECG	8.268	2.491	3.008
C-200AECG	10.232	3.123	3.736
C-250AECG	13.102	4.444	4.437
C-300AECG	13.067	4.459	4.933
C-400AECG	16.236	5.590	5.976

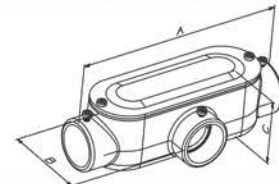

CAT#	A	B	C
T-50AECG	4.825	2.089	1.687
T-75AECG	5.646	2.241	1.900
T-100AECG	6.467	2.523	2.193
T-125AECG	8.268	3.450	3.008
T-150AECG	8.268	3.460	3.008
T-200AECG	10.232	4.089	3.736

CONDUIT BODIES FOR RIGID THREADED TYPE - ALUMINUM

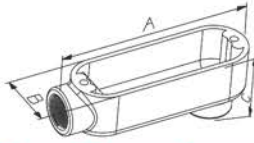

CAT#	A	B	C
LB-50A	4.359	1.330	2.060
LB-75A	4.972	1.552	2.370
LB-100A	5.819	1.747	2.630
LB-125A	7.795	2.491	3.500
LB-150A	7.807	2.491	3.750
LB-200A	9.850	3.123	4.310
LB-250A	12.673	4.444	4.450
LB-300A	12.583	4.459	4.450
LB-350A	15.661	5.590	5.800
LB-400A	15.661	5.590	5.800

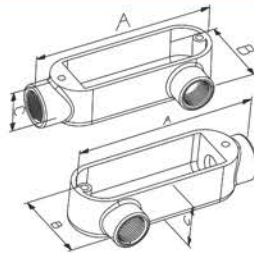

CAT#	A	B	C
LL/LR-50A	4.359	2.015	1.412
LL/LR-75A	4.972	2.299	1.655
LL/LR-100A	5.819	2.427	1.894
LL/LR-125A	7.795	3.391	2.685
LL/LR-150A	7.807	3.412	2.685
LL/LR-200A	9.850	4.082	3.425
LL/LR-250A	12.673	5.878	3.984
LL/LR-300A	12.583	5.898	4.448
LL/LR-350A	15.661	7.681	5.559
LL/LR-400A	15.661	7.681	5.559

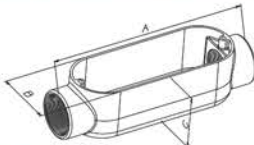

CAT#	A	B	C
C-50A	4.825	1.330	1.412
C-75A	5.646	1.552	1.655
C-100A	6.467	1.747	1.894
C-125A	8.268	2.491	2.685
C-150A	8.268	2.491	2.685
C-200A	10.232	3.123	3.425
C-250A	13.102	4.444	3.984
C-300A	13.067	4.459	4.448
C-350A	16.236	5.590	5.559
C-400A	16.236	5.590	5.559

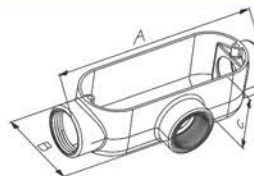

CAT#	A	B	C
T-50A	4.825	2.089	1.412
T-75A	5.646	2.241	1.655
T-100A	6.467	2.523	1.894
T-125A	8.268	3.450	2.685
T-150A	8.268	3.460	2.685
T-200A	10.232	4.089	3.425
T-250A	13.102	5.850	3.984
T-300A	13.067	7.648	4.448

CATALOG NUMBER	TRADE SIZE	INNER CARTON	MASTER CARTON
LB-50A	1/2"	-	100
LB-75A	3/4"	-	100
LB-100A	1"	-	50
LB-125A	1-1/4"	-	25
LB-150A	1-1/2"	-	20
LB-200A	2"	-	10
LB-250A	2-1/2"	-	6
LB-300A	3"	-	6
LB-400A	4"	-	2

CATALOG NUMBER	TRADE SIZE	INNER CARTON	MASTER CARTON
LL-50A	1/2"	-	100
LL-75A	3/4"	-	50
LL-100A	1"	-	50
LL-125A	1-1/4"	-	20
LL-150A	1-1/2"	-	20
LL-200A	2"	-	10
LL-250A	2-1/2"	-	6
LL-300A	3"	-	6
LL-400A	4"	-	2

CATALOG NUMBER	TRADE SIZE	INNER CARTON	MASTER CARTON
LR-50A	1/2"	-	100
LR-75A	3/4"	-	50
LR-100A	1"	-	50
LR-125A	1-1/4"	-	20
LR-150A	1-1/2"	-	20
LR-200A	2"	-	10
LR-250A	2-1/2"	-	6
LR-300A	3"	-	6
LR-400A	4"	-	2

CATALOG NUMBER	TRADE SIZE	INNER CARTON	MASTER CARTON
C-50A	1/2"	-	100
C-75A	3/4"	-	100
C-100A	1"	-	50
C-125A	1-1/4"	-	20
C-150A	1-1/2"	-	20
C-200A	2"	-	10
C-250A	2-1/2"	-	6
C-300A	3"	-	6
C-400A	4"	-	2

CATALOG NUMBER	TRADE SIZE	INNER CARTON	MASTER CARTON
T-50A	1/2"	-	100
T-75A	3/4"	-	50
T-100A	1"	-	50
T-125A	1-1/4"	-	10
T-150A	1-1/2"	-	10
T-200A	2"	-	10
T-250A	2-1/2"	-	4
T-300A	3"	-	4



C  US
E360998



C  US
E360998



C  US
E360998



C  US
E360998



C  US
E360998

CONDUIT BODIES FOR RIGID THREADED TYPE WITH COVERS & GASKETS - ALUMINUM



UL US
E360998

CATALOG NUMBER	TRADE SIZE	INNER CARTON	MASTER CARTON
LB-50ACG	1/2"	-	100
LB-75ACG	3/4"	-	100
LB-100ACG	1"	-	50
LB-125ACG	1-1/4"	-	20
LB-150ACG	1-1/2"	-	20
LB-200ACG	2"	-	10
LB-250ACG	2-1/2"	-	6
LB-300ACG	3"	-	6
LB-400ACG	4"	-	2

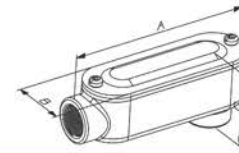

CAT#	A	B	C
LB-50ACG	4.359	1.330	2.150
LB-75ACG	4.972	1.552	2.430
LB-100ACG	5.819	1.747	2.765
LB-125ACG	7.795	2.491	3.665
LB-150ACG	7.807	2.491	3.665
LB-200ACG	9.850	3.123	4.275
LB-250ACG	12.673	4.444	5.437
LB-300ACG	12.583	4.459	5.675
LB-400ACG	15.661	5.590	6.922



UL US
E360998

CATALOG NUMBER	TRADE SIZE	INNER CARTON	MASTER CARTON
LL-50ACG	1/2"	-	100
LL-75ACG	3/4"	-	100
LL-100ACG	1"	-	50
LL-125ACG	1-1/4"	-	20
LL-150ACG	1-1/2"	-	20
LL-200ACG	2"	-	10
LL-250ACG	2-1/2"	-	6
LL-300ACG	3"	-	6
LL-400ACG	4"	-	2

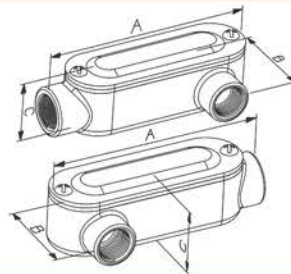

CAT#	A	B	C
LL/LR-50ACG	4.359	2.015	1.687
LL/LR-75ACG	4.972	2.299	1.900
LL/LR-100ACG	5.819	2.427	2.193
LL/LR-125ACG	7.795	3.391	3.008
LL/LR-150ACG	7.807	3.412	3.008
LL/LR-200ACG	9.850	4.082	3.736
LL/LR-250ACG	12.673	5.878	4.437
LL/LR-300ACG	12.583	5.898	4.933
LL/LR-400ACG	15.661	7.681	5.976



UL US
E360998

CATALOG NUMBER	TRADE SIZE	INNER CARTON	MASTER CARTON
LR-50ACG	1/2"	-	100
LR-75ACG	3/4"	-	100
LR-100ACG	1"	-	50
LR-125ACG	1-1/4"	-	20
LR-150ACG	1-1/2"	-	20
LR-200ACG	2"	-	10
LR-250ACG	2-1/2"	-	6
LR-300ACG	3"	-	6
LR-400ACG	4"	-	2

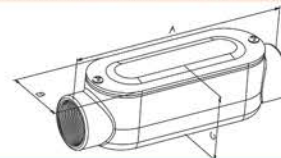

CAT#	A	B	C
C-50ACG	4.825	1.330	1.687
C-75ACG	5.646	1.552	1.900
C-100ACG	6.467	1.747	2.193
C-125ACG	8.268	2.491	3.008
C-150ACG	8.268	2.491	3.008
C-200ACG	10.232	3.123	3.736
C-250ACG	13.102	4.444	4.437
C-300ACG	13.067	4.459	4.933
C-400ACG	16.236	5.590	5.976



UL US
E360998

CATALOG NUMBER	TRADE SIZE	INNER CARTON	MASTER CARTON
C-50ACG	1/2"	-	100
C-75ACG	3/4"	-	100
C-100ACG	1"	-	50
C-125ACG	1-1/4"	-	20
C-150ACG	1-1/2"	-	10
C-200ACG	2"	-	10
C-250ACG	2-1/2"	-	4
C-300ACG	3"	-	4
C-400ACG	4"	-	1

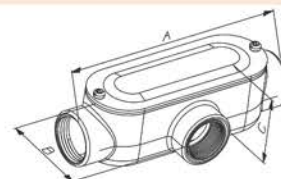

CAT#	A	B	C
C-50ACG	4.825	2.089	1.687
C-75ACG	5.646	2.241	1.900
C-100ACG	6.467	2.523	2.193
C-125ACG	8.268	3.450	3.008
C-150ACG	8.268	3.460	3.008
C-200ACG	10.232	4.089	3.736
C-250ACG	13.102	5.850	4.437
C-300ACG	13.067	5.850	4.933
C-400ACG	16.236	7.648	5.976



UL US
E360998

CATALOG NUMBER	TRADE SIZE	INNER CARTON	MASTER CARTON
T-50ACG	1/2"	-	100
T-75ACG	3/4"	-	50
T-100ACG	1"	-	25
T-125ACG	1-1/4"	-	10
T-150ACG	1-1/2"	-	10
T-200ACG	2"	-	10
T-250ACG	2-1/2"	-	4
T-300ACG	3"	-	4
T-400ACG	4"	-	1

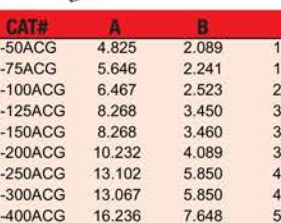

EMT & RIGID



EMT CONNECTORS - SET SCREW TYPE - STEEL

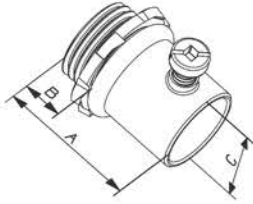

CAT#	A	B	C
66001	1.314	0.407	0.848
66002	1.468	0.417	1.057
66003	1.685	0.492	1.338
66004	2.106	0.574	1.688
66005	2.283	0.633	1.929
66006	2.598	0.720	2.381
66007	3.299	0.720	3.161
66008	3.779	0.889	3.787
66009	3.921	0.889	4.283
66010	4.039	0.889	4.803

CATALOG NUMBER	TRADE SIZE	INNER CARTON	MASTER CARTON
66001	1/2"	50	500
66002	3/4"	25	250
66003	1"	20	200
66004	1 1/4"	-	25
66005	1 1/2"	-	25
66006	2"	-	20
66007	2 1/2"	-	12
66008	3"	-	12
66009	3 1/2"	-	6
66010	4"	-	6



E315281 1/2" - 2"
E315256 2 1/2" - 4"

EMT CONNECTORS - SET SCREW TYPE - WITH INSULATED THROAT - STEEL

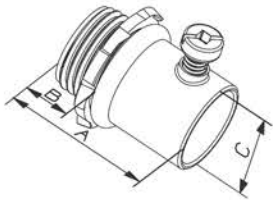

CAT#	A	B	C
66001 - A	1.370	0.460	0.848
66002 - A	1.535	0.488	1.057
66003 - A	1.744	0.551	1.338
66005 - A	2.362	0.712	1.929
66006 - A	2.677	0.799	2.381
66007 - A	3.378	0.799	3.161
66008 - A	3.858	0.799	3.787
66009 - A	4.000	0.968	4.283
66010 - A	4.118	0.968	4.803

CATALOG NUMBER	TRADE SIZE	INNER CARTON	MASTER CARTON
66001 - A	1/2"	50	500
66002 - A	3/4"	25	250
66003 - A	1"	20	200
66005 - A	1 1/2"	-	25
66006 - A	2"	-	20
66007 - A	2 1/2"	-	12
66008 - A	3"	-	12
66009 - A	3 1/2"	-	6
66010 - A	4"	-	6



E315281 1/2" - 2"
E315256 2 1/2" - 4"

EMT COUPLINGS - SET SCREW TYPE - STEEL

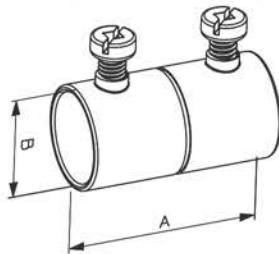

CAT#	A	B
66201	1.582	0.848
66202	1.811	1.057
66203	2.047	1.338
66204	2.724	1.688
66205	3.007	1.929
66206	3.248	2.381
66207	4.094	3.161
66208	4.350	3.787
66209	4.574	4.283
66210	4.724	4.803

CATALOG NUMBER	TRADE SIZE	INNER CARTON	MASTER CARTON
66201	1/2"	50	500
66202	3/4"	25	250
66203	1"	10	100
66204	1 1/4"	-	25
66205	1 1/2"	-	25
66206	2"	-	20
66207	2 1/2"	-	12
66208	3"	-	12
66209	3 1/2"	-	6
66210	4"	-	6



E315281 1/2" - 2"
E315256 2 1/2" - 4"

EMT CONNECTORS - COMPRESSION TYPE - STEEL



E315281 1/2" - 2"
E315256 2 1/2" - 4"

CATALOG NUMBER	TRADE SIZE	INNER CARTON	MASTER CARTON
66101	1/2"	25	250
66102	3/4"	25	250
66103	1"	10	100
66104	1 1/4"	-	25
66105	1 1/2"	-	10
66106	2"	-	10
66107	2 1/2"	-	12
66108	3"	-	12
66109	3 1/2"	-	6
66110	4"	-	6

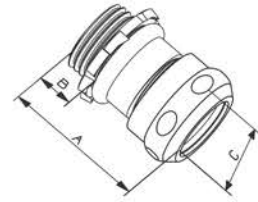

CAT#	A	B	C
66101	1.709	0.417	1.079
66102	1.823	0.421	1.299
66103	2.059	0.449	1.543
66104	2.429	0.578	1.886
66105	2.736	0.591	2.106
66106	2.965	0.713	2.575
66107	3.724	0.795	3.406
66108	4.335	0.878	4.063
66109	4.303	0.858	4.543
66110	4.543	0.909	5.059

EMT CONNECTOR - COMPRESSION TYPE - WITH INSULATED THROAT - STEEL



E315281 1/2" - 2"
E315256 2 1/2" - 4"

CATALOG NUMBER	TRADE SIZE	INNER CARTON	MASTER CARTON
66101-A	1/2"	25	250
66102-A	3/4"	25	250
66103-A	1"	10	100
66104-A	1 1/4"	-	25
66105-A	1 1/2"	-	10
66106-A	2"	-	10
66107-A	2 1/2"	-	12
66108-A	3"	-	12
66109-A	3 1/2"	-	6
66110-A	4"	-	6

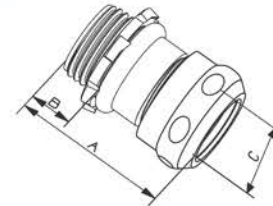

CAT#	A	B	C
66101-A	1.749	0.457	1.079
66102-A	1.863	0.461	1.299
66103-A	2.099	0.489	1.543
66104-A	2.469	0.618	1.886
66105-A	2.776	0.631	2.106
66106-A	3.005	0.753	2.575
66107-A	3.764	0.835	3.406
66108-A	4.375	0.918	4.063
66109-A	4.343	0.898	4.543
66110-A	4.583	0.949	5.059

EMT COUPLING - COMPRESSION TYPE - STEEL



E315281 1/2" - 2"
E315256 2 1/2" - 4"

CATALOG NUMBER	TRADE SIZE	INNER CARTON	MASTER CARTON
66301	1/2"	50	250
66302	3/4"	25	250
66303	1"	10	100
66304	1 1/4"	-	25
66305	1 1/2"	-	10
66306	2"	-	10
66307	2 1/2"	-	12
66308	3"	-	12
66309	3 1/2"	-	6
66310	4"	-	6

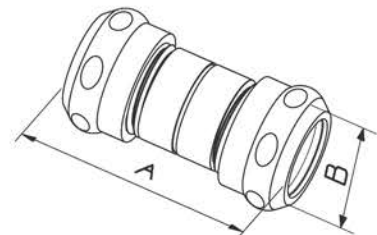

CAT#	A	B
66301	2.055	1.079
66302	2.185	1.299
66303	2.323	1.543
66304	2.854	1.886
66305	2.992	2.106
66306	2.913	2.575
66307	4.815	3.406
66308	5.220	4.063
66309	5.425	4.543
66310	5.276	5.059

EMT CONNECTORS - SET SCREW TYPE - ZINC DIE CAST

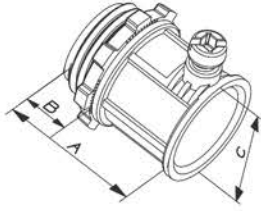

CAT#	A	B	C
88036	1.157	0.382	0.933
88037	1.378	0.366	1.169
88038	1.504	0.500	1.421
88039	1.969	1.535	1.823
88040	2.260	1.768	2.067
88041	2.563	2.228	2.524
88042	3.090	1.047	3.295
88043	3.374	1.059	3.909
88044	3.460	1.059	4.460
88045	3.759	1.110	4.881

CATALOG NUMBER	TRADE SIZE	INNER CARTON	MASTER CARTON
88036	1/2"	50	500
88037	3/4"	25	250
88038	1"	20	200
88039	1-1/4"	-	25
88040	1-1/2"	-	25
88041	2"	-	20
88042	2 1/2"	-	12
88043	3"	-	12
88044	3 1/2"	-	10
88045	4"	-	6



E315281 1/2" - 2"
E315256 2 1/2" - 4"

EMT CONNECTOR - SET SCREW WITH INSULATED THROAT - ZINC DIE CAST

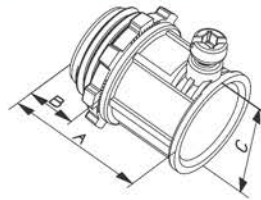

CAT#	A	B	C
88036 - A	1.196	0.421	0.933
88037 - A	1.417	0.405	1.169
88038 - A	1.543	0.539	1.421
88039 - A	2.008	1.574	1.823
88040 - A	2.299	1.807	2.067
88045 - A	3.818	1.169	4.881

CATALOG NUMBER	TRADE SIZE	INNER CARTON	MASTER CARTON
88036 - A	1/2"	50	500
88037 - A	3/4"	25	250
88038 - A	1"	20	200
88039 - A	1 1/4"	-	25
88040 - A	1 1/2"	-	25
88045 - A	4"	-	6



E315281 1/2" - 2"
E315256 2 1/2" - 4"

EMT COUPLING - SET SCREW TYPE - ZINC DIE CAST

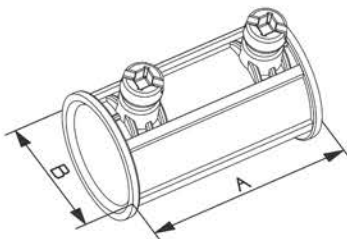

CAT#	A	B
88062	1.488	0.905
88063	1.944	1.177
88064	2.275	1.413
88065	2.618	1.822
88066	2.909	2.039
88067	3.476	2.515
88068	4.011	3.303
88069	4.460	3.913
88070	4.850	4.520
88071	5.248	4.909

CATALOG NUMBER	TRADE SIZE	INNER CARTON	MASTER CARTON
88062	1/2"	50	500
88063	3/4"	25	250
88064	1"	20	200
88065	1-1/4"	-	25
88066	1-1/2"	-	25
88067	2"	-	20
88068	2 1/2"	-	12
88069	3"	-	12
88070	3 1/2"	-	10
88071	4"	-	6



E315281 1/2" - 2"
E315256 2 1/2" - 4"

EMT CONNECTOR - COMPRESSION TYPE - ZINC DIE CAST



E315281 1/2" - 2"
E315256 2 1/2" - 4"

CATALOG NUMBER	TRADE SIZE	INNER CARTON	MASTER CARTON
88046	1/2"	50	500
88047	3/4"	25	250
88048	1"	15	150
88049	1 1/4"	10	100
88050	1 1/2"	-	10
88051	2"	-	10
88052	2 1/2"	-	12
88053	3"	-	12
88055	4"	-	6

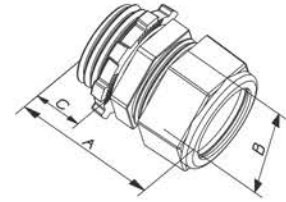

CAT#	A	B	C
88046	1.256	0.965	0.433
88047	1.209	1.264	0.433
88048	1.575	1.516	0.547
88049	1.618	1.906	0.575
88050	1.874	2.276	0.622
88051	2.146	2.610	0.756
88052	2.610	3.311	1.004
88053	2.790	4.210	1.004
88055	2.839	5.350	1.087

EMT COUPLING - COMPRESSION TYPE - ZINC DIE CAST



E315281 1/2" - 2"
E315256 2 1/2" - 4"

CATALOG NUMBER	TRADE SIZE	INNER CARTON	MASTER CARTON
88072	1/2"	50	500
88073	3/4"	25	250
88074	1"	15	150
88075	1 1/4"	5	50
88076	1 1/2"	-	10
88077	2"	-	10
88078	2 1/2"	-	12
88079	3"	-	12
88081	4"	-	6

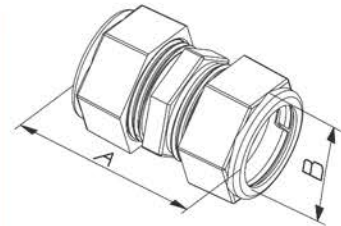

CAT#	A	B
88072	1.531	0.965
88073	1.579	1.264
88074	1.870	1.516
88075	2.248	1.906
88076	3.181	2.276
88077	2.437	2.610
88078	3.362	3.311
88079	3.349	4.210
88081	3.573	5.350

COMBINATION COUPLINGS - EMT TO ROMEX & FLEX - ZINC DIE CAST

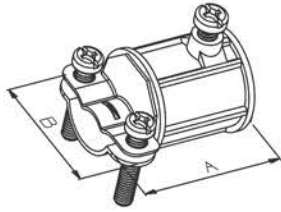

CATALOG NUMBER	TRADE SIZE	INNER CARTON	MASTER CARTON
82042	3/8"-1/2"	-	500



CAT#	A	B
82042	1.318	1.173

PULL ELBOWS - EMT TO EMT - ZINC DIE CAST



CATALOG NUMBER	TRADE SIZE	INNER CARTON	MASTER CARTON
85088	1/2"	-	100
85089	3/4"	-	50
85090	1"	-	25



CAT#	A	B
85088	1.311	0.961
85089	1.385	1.230
85090	1.961	1.516

COMBINATION COUPLINGS (E.M.T. TO FLEXIBLE CONDUIT) - ZINC DIE CAST



CATALOG NUMBER	TRADE SIZE	INNER CARTON	MASTER CARTON
82043	1/2" TO 1/2"	-	250
82044	3/4" TO 3/4"	-	250

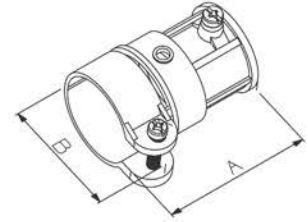

CAT#	A	B
82043	1.646	1.417
82044	1.972	1.547

PULL ELBOWS - EMT/RICD TO EMT/RICD - ZINC DIE CAST



CATALOG NUMBER	TRADE SIZE	INNER CARTON	MASTER CARTON
86201	1/2"	-	100
86202	3/4"	-	50

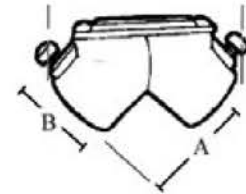

CAT#	A	B
86201	1.311	0.961
86202	1.385	1.230

EMT ELBOWS - 90° - STEEL



CATALOG NUMBER	TRADE SIZE	INNER CARTON	MASTER CARTON
90001	1/2"	-	50
90002	3/4"	-	50
90003	1"	-	25
90004	1 1/4"	-	20
90005	1 1/2"	-	20
90006	2"	-	12
90007	2 1/2"	-	1
90008	3"	-	1
90009	3 1/2"	-	1
90010	4"	-	1

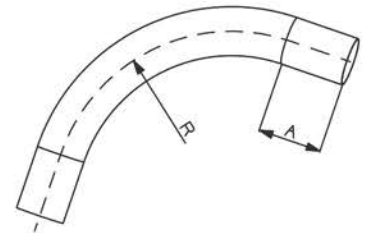

CAT#	A(MIN)	R
90001	1.500	4.000
90002	1.500	4.500
90003	1.875	5.750
90004	2.000	7.250
90005	2.000	8.250
90006	2.000	9.500
90007	3.000	10.500
90008	3.125	13.000
90009	3.250	15.000
90010	3.375	16.000

E.M.T. STRAP ONE HOLE - STEEL



E331642

CATALOG NUMBER	TRADE SIZE	INNER CARTON	MASTER CARTON
62021	1/2"	100	1000
62022	3/4"	50	500
62023	1"	50	500
62024	1 1/4"	-	50
62025	1 1/2"	-	25
62026	2"	-	25
62027	2 1/2"	-	50
62028	3"	-	25
62029	3 1/2"	-	25
62030	4"	-	25

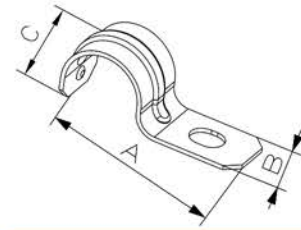

CAT#	A	B	C
62021	1.657	0.571	0.665
62022	1.937	0.646	0.933
62023	2.276	0.772	1.110
62024	2.858	0.878	1.480
62025	3.126	1.000	1.673
62026	3.921	1.138	2.020
62027	5.012	1.173	2.602
62028	5.374	1.215	3.291
62029	6.390	1.254	4.248
62030	6.850	1.157	4.177

E.M.T. STRAP - TWO HOLES - STEEL



E331642

CATALOG NUMBER	TRADE SIZE	INNER CARTON	MASTER CARTON
62121	1/2"	100	1000
62122	3/4"	100	1000
62123	1"	50	500
62124	1 1/4"	25	250
62125	1 1/2"	-	100
62126	2"	-	20
62127	2 1/2"	-	25
62128	3"	-	25
62129	3 1/2"	-	25
62130	4"	-	25

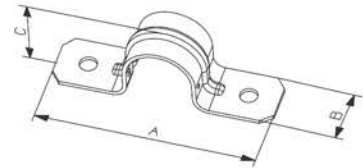

CAT#	A	B	C
62121	2.240	0.574	0.732
62122	2.756	0.636	0.965
62123	3.252	0.713	1.157
62124	3.831	0.748	1.453
62125	4.323	0.791	1.957
62126	4.925	1.004	2.205
62127	6.106	1.004	2.969
62128	6.772	1.004	3.539
62129	7.425	1.004	4.110
62130	9.366	1.016	4.508

HANGERS FOR RIGID CONDUIT, IMC CONDUIT & E.M.T. - WITH BOLTS (ASSEMBLED) - STEEL



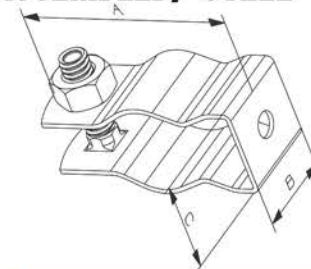

E331642

CATALOG NUMBER	FOR EMT	FOR RGD	INNER CARTON	MASTER CARTON
62501	1/2"	3/8" & 1/2"	50	500
62502	3/4"	3/4"	-	50
62503	1"	1"	-	50
62505	1 1/2"	1 1/4"	-	50
62506	2"	2"	-	25

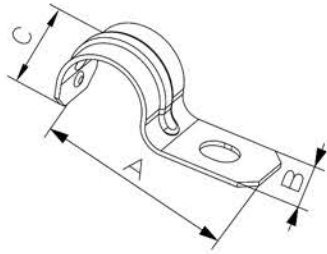

CAT#	A	B	C
62501	1.929	0.752	0.752
62502	2.280	0.886	0.945
62503	2.516	0.886	0.913
62505	3.386	0.967	1.126
62506	4.213	1.185	1.386

RIGID STRAP - ONE HOLE - STEEL



CATALOG NUMBER	TRADE SIZE	INNER CARTON	MASTER CARTON
62001	1/2"	100	1000
62002	3/4"	50	500
62003	1"	25	250
62004	1 1/4"	-	50
62005	1 1/2"	-	25
62006	2"	-	25



CAT#	A	B	C
62001	1.949	0.634	0.933
62002	2.213	0.732	1.102
62003	2.657	0.878	1.264
62004	3.031	0.866	1.626
62005	3.681	1.008	1.953
62006	4.141	1.189	2.248



RIGID STRAP - TWO HOLES - STEEL

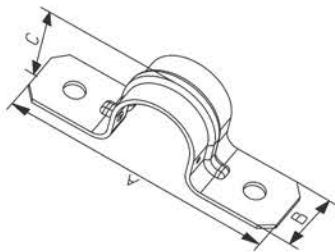

CATALOG NUMBER	TRADE SIZE	INNER CARTON	MASTER CARTON
62101	1/2"	100	1000
62102	3/4"	50	500
62103	1"	25	250
62104	1 1/4"	25	250
62105	1 1/2"	-	50
62106	2"	-	50



CAT#	A	B	C
62101	2.551	0.504	0.874
62102	2.898	0.567	1.118
62103	3.453	0.638	1.331
62104	4.268	0.866	1.673
62105	4.760	0.941	1.984
62106	5.079	1.000	2.295



CONDUIT LOCKNUTS - ZINC DIE CAST



CATALOG NUMBER	TRADE SIZE	INNER CARTON	MASTER CARTON
82201	1/2"	200	2000
82202	3/4"	100	1000
82203	1"	100	1000
82204	1 1/4"	50	500
82205	1 1/2"	50	500
82206	2"	50	200
82207	2 1/2"	25	100
82208	3"	25	100
82209	3 1/2"	10	40
82210	4"	10	40

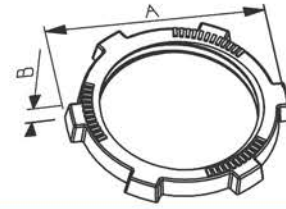

CAT#	A	B
82201	1.087	0.122
82202	1.358	0.142
82203	1.661	0.157
82204	2.047	0.157
82205	2.366	0.181
82206	2.929	0.187
82207	3.449	0.248
82208	4.189	0.232
82209	4.646	0.283
82210	5.146	0.240

CONDUIT LOCKNUTS - STEEL



CATALOG NUMBER	TRADE SIZE	INNER CARTON	MASTER CARTON
62201	1/2"	200	2000
62202	3/4"	100	1000
62203	1"	100	1000
62204	1 1/4"	50	500
62205	1 1/2"	50	500
62206	2"	50	200
62207	2 1/2"	25	100
62208	3"	25	100

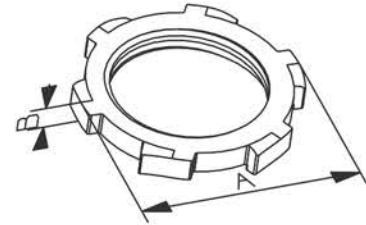

CAT#	A	B
62201	1.134	0.106
62202	1.390	0.118
62203	1.709	0.154
62204	2.059	0.154
62205	2.358	0.154
62206	2.858	0.157
62207	3.429	0.197
62208	4.110	0.197

OFFSET CONNECTOR - ZINC DIE CAST



CATALOG NUMBER	TRADE SIZE	INNER CARTON	MASTER CARTON
85078	1/2"	10	100
85079	3/4"	10	100
85080	1"	10	100
85081	1 1/4"	5	50
85082	1 1/2"	5	50
85083	2"	2	20
85084	2 1/2"	-	10
85085	3"	-	4

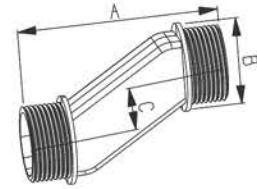

CAT#	A	B	C
85078	2.440	0.915	0.705
85079	2.602	1.125	0.635
85080	2.720	1.398	0.717
85081	2.920	1.835	0.780
85082	3.020	2.047	0.780
85083	3.120	2.590	0.750
85084	4.045	3.320	0.745
85085	4.545	3.860	0.705

PULL ELBOWS - RIGID TO RIGID - ZINC DIE CAST



CATALOG NUMBER	TRADE SIZE	INNER CARTON	MASTER CARTON
85101	1/2"	10	100
85102	3/4"	5	50
85103	1"	-	25

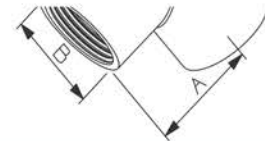

CAT#	A	B
85101	1.311	0.992
85102	1.385	1.260
85103	1.961	1.516

CONDUIT NIPPLES - ZINC DIE CAST



CATALOG NUMBER	TRADE SIZE	INNER CARTON	MASTER CARTON
87001	1/2"	100	1000
87002	3/4"	50	500
87003	1"	25	250
87004	1-1/4"	25	250
87005	1-1/2"	25	100
87006	2"	10	40

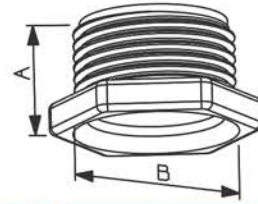

CAT#	A	B
87001	0.585	0.936
87002	0.710	1.175
87003	0.848	1.395
87004	0.865	1.743
87005	0.905	2.117
87006	0.941	2.519

METALLIC CONDUIT BUSHING - ZINC DIE CAST



CATALOG NUMBER	TRADE SIZE	INNER CARTON	MASTER CARTON
88351	1/2"	100	1000
88352	3/4"	100	1000
88353	1"	50	500
88354	1 1/4"	25	250
88355	1 1/2"	10	100
88356	2"	25	100
88357	2 1/2"	-	50
88358	3"	-	25
88359	3 1/2"	-	10
88360	4"	-	10

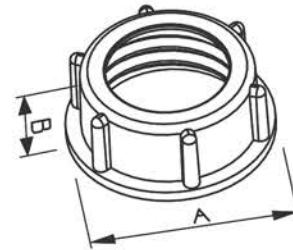

CAT#	A	B
88351	1.059	0.409
88352	1.276	0.409
88353	1.535	0.496
88354	1.888	0.539
88355	2.122	0.618
88356	2.636	0.512
88357	3.228	0.622
88358	3.823	0.827
88359	4.359	0.846
88360	4.945	0.846

CAPPED METALLIC CONDUIT BUSHING - ZINC DIE CAST

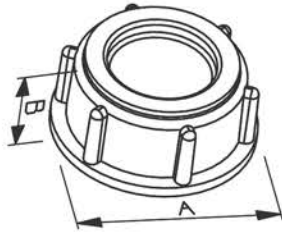

CAT#	A	B
88351-ST	1.059	0.409
88352-ST	1.276	0.409
88353-ST	1.535	0.496
88354-ST	1.888	0.539
88355-ST	2.122	0.618
88356-ST	2.636	0.512
88357-ST	3.228	0.622
88358-ST	3.823	0.827
88359-ST	4.359	0.846
88360-ST	4.945	0.846

CATALOG NUMBER	TRADE SIZE	INNER CARTON	MASTER CARTON
88351-ST	1/2"	100	1000
88352-ST	3/4"	100	1000
88353-ST	1"	50	500
88354-ST	1 1/4"	25	250
88355-ST	1 1/2"	10	100
88356-ST	2"	25	100
88357-ST	2 1/2"	-	50
88358-ST	3"	-	25
88359-ST	3 1/2"	-	10
88360-ST	4"	-	10



METALLIC CONDUIT BUSHING WITH PLASTIC THROAT - ZINC DIE CAST

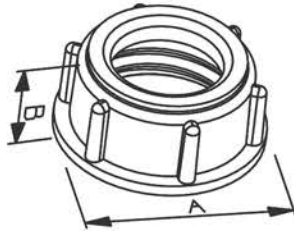

CAT#	A	B
88351-A	1.059	0.409
88352-A	1.276	0.409
88353-A	1.535	0.496
88354-A	1.888	0.539
88355-A	2.122	0.618
88356-A	2.636	0.512
88357-A	3.228	0.622
88358-A	3.823	0.827
88360-A	4.945	0.846

CATALOG NUMBER	TRADE SIZE	INNER CARTON	MASTER CARTON
88351-A	1/2"	100	1000
88352-A	3/4"	100	1000
88353-A	1"	50	500
88354-A	1-1/4"	25	250
88355-A	1-1/2"	10	100
88356-A	2"	25	100
88357-A	2-1/2"	-	50
88358-A	3"	-	25
88360-A	4"	-	10



WATER TIGHT HUBS - ZINC DIE CAST

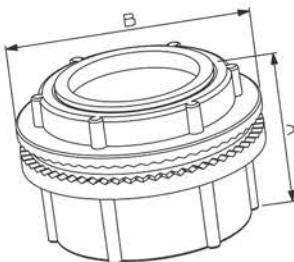

CAT#	A	B
88501	1.406	1.406
88502	1.539	1.661
88503	1.752	1.949
88504	1.689	2.409
88505	1.713	2.693
88506	1.831	3.201
88507	2.594	3.685
88508	2.614	4.385
88509	2.440	4.880
88510	2.559	5.437

CATALOG NUMBER	TRADE SIZE	INNER CARTON	MASTER CARTON
88501	1/2"	25	250
88502	3/4"	10	100
88503	1"	10	100
88504	1 1/4"	2	20
88505	1 1/2"	2	20
88506	2"	2	20
88507	2 1/2"	-	2
88508	3"	-	2
88509	3 1/2"	-	1
88510	4"	-	1



WATER TIGHT HUBS - BONDING SCREW - ZINC DIE CAST



CATALOG NUMBER	TRADE SIZE	INNER CARTON	MASTER CARTON
88502-G	1/2"	10	100
88503-G	3/4"	10	100

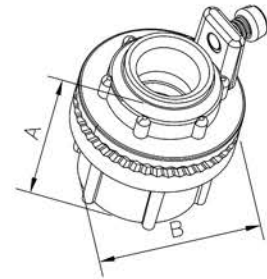

CAT#	A	B
88502-G	1.539	1.661
88503-G	1.752	1.949



CONNECTORS FOR RIGID & IMC CONDUIT - SET SCREW TYPE - ZINC DIE CAST



CATALOG NUMBER	TRADE SIZE	INNER CARTON	MASTER CARTON
88601	1/2"	50	500
88602	3/4"	25	250

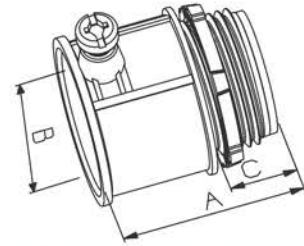

CAT#	A	B	C
88601	1.299	1.063	0.382
88602	1.492	1.338	0.437



RIGID CONDUIT STANDARD RADIUS ELBOWS 90° - STEEL



CATALOG NUMBER	TRADE SIZE	INNER CARTON	MASTER CARTON
90207	2 1/2"	-	1
90208	3"	-	1
90210	4"	-	1

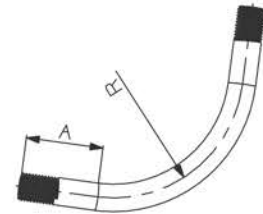

CAT#	A(MIN)	R
90207	3.000	10.500
90208	3.125	13.000
90210	3.375	16.000



BOX SUPPORT



SOLID WIRE GROUNDING PIGTAIL

CATALOG NUMBER	TRADE SIZE	INNER CARTON	MASTER CARTON
11601-1	7-1/2" 12 AWG	100	1000



GREEN GROUND SCREW

CATALOG NUMBER	TRADE SIZE	INNER CARTON	MASTER CARTON
11801	#10-32 x 3/8"	100	1000



4" SQUARE DEVICE RINGS FLAT OR DRAWN - STEEL

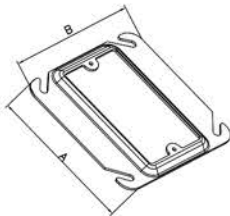

CATALOG NUMBER	TRADE SIZE	INNER CARTON	MASTER CARTON
65937	Raised 1/4"	-	200
65938	Raised 1/2"	-	200



CAT#	A	B
65937	4.130	4.130
65938	4.130	4.130



STEEL BOX BRACKET TO STUD - GALVANIZED STEEL



UL US
E358603

CATALOG NUMBER	WALL DEPTH	INNER CARTON	MASTER CARTON
62631	2-1/2" & 3-5/8"	-	50

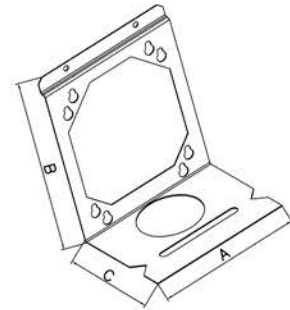

CAT#	A	B	C
62631	4.504	5.626	3.484

STEEL BOX BRACKET TO STUD - GALVANIZED STEEL



UL US
E358603

CATALOG NUMBER	WALL DEPTH	INNER CARTON	MASTER CARTON
62633	2 1/2" Thru 6"	-	50

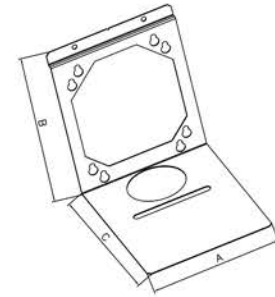

CAT#	A	B	C
62633	4.504	5.626	5.846

TELESCOPING SCREW GUN BOX BRACKET 16" - 24" - GALVANIZED STEEL



UL US
E358603

CATALOG NUMBER	BOX DEPTH	INNER CARTON	MASTER CARTON
62634	1-1/2", 2 1/2" & 2 1/8"	-	50
62636	11 - 1/2" - 17 - 3/4"	-	50

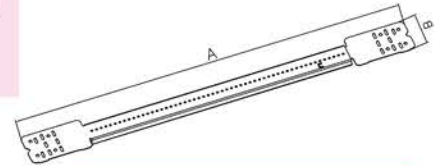

CAT#	A	B
62634	17.690	1.500
62636	-	-

3 DEVICE RIGID BOX SUPPORT - GALVANIZED STEEL



UL US
E358603

CATALOG NUMBER	BOX DEPTH	INNER CARTON	MASTER CARTON
62637	1-1/2" & 2-1/8"	-	25

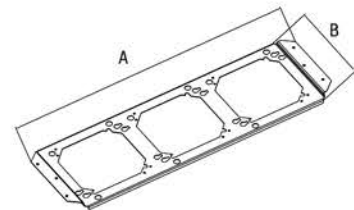

CAT#	A	B
62637	15.9050	5.0236

4 DEVICE RIGID BOX SUPPORT - GALVANIZED STEEL

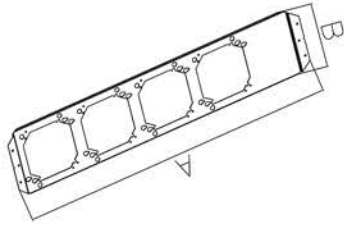

CAT#	A	B
62638	24.015	5.0236

CATALOG NUMBER	BOX DEPTH	INNER CARTON	MASTER CARTON
62638	1-1/2" & 2-1/8"	-	25



C  US
E358603

T-GRID BOX HANGER 24" SPAN - GALVANIZED STEEL

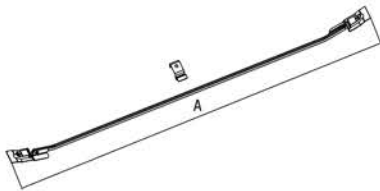

CAT#	A
62639	28.000

CATALOG NUMBER	WALL DEPTH	INNER CARTON	MASTER CARTON
62639	-	-	50



C  US
E358603

T-GRID BOX HANGER W/ MOUNTING CLIP - HEAVY DUTY - GALVANIZED STEEL

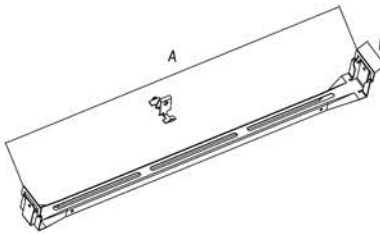

CAT#	A	B
62640	24.000	2.000

CATALOG NUMBER	BOX DEPTH	LENGTH	INNER CARTON	MASTER CARTON
62640	1-1/2" & 2-1/8"	24	-	25



C  US
E358603

MC/NM STUD WALL CABLE SUPPORT - GALVANIZED STEEL

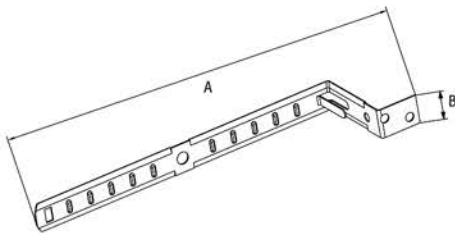

CAT#	A	B
62641	8.050	0.630

CATALOG NUMBER	BOX DEPTH	INNER CARTON	MASTER CARTON
62641	1-1/2" & 2-1/8"	-	100



C  US
E331642

STRUT CLAMP - STEEL



CATALOG NUMBER	TRADE SIZE	INNER CARTON	MASTER CARTON
62901	1/2"	-	250
62902	3/4"	-	250
62903	1"	-	250
62904	1 1/4"	-	200
62905	1 1/2"	-	200
62906	2"	-	200
62907	2 1/2"	-	150
62908	3"	-	80
62910	4"	-	80

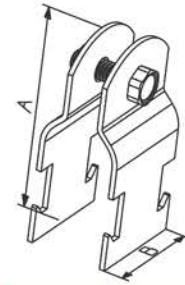

CAT#	A	B
62901	2.204	1.257
62902	2.461	1.257
62903	2.764	1.257
62904	3.315	1.257
62905	3.417	1.257
62906	4.063	1.257
62907	5.035	1.257
62908	6.000	1.257
62910	6.634	1.257

DRIVE STRAPS - STEEL



CATALOG NUMBER	TRADE SIZE	INNER CARTON	MASTER CARTON
65601	1/2"	100	1000
65602	3/4"	100	1000
65603	1"	50	500

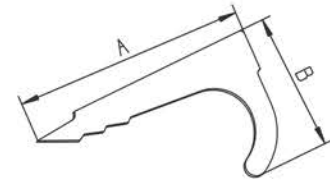

CAT#	A	B
65601	1.961	1.085
65602	2.091	1.282
65603	2.185	1.542

PERFORATED STRAP - IRON

CATALOG NUMBER	TRADE SIZE	INNER CARTON	MASTER CARTON
62301	GALVANIZED	-	10



CEILING BOX SUPPORT - CBS BARS - STEEL

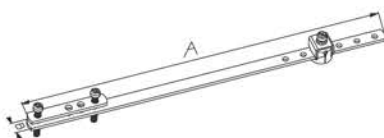

CATALOG NUMBER	TRADE SIZE	INNER CARTON	MASTER CARTON
62401	FOR CEILING BOX	-	50



CAT#	A	B
62401	11.024	0.520

LIQUIDTIGHT



LIQUID-TIGHT CONNECTORS - 90° ANGLE - ZINC DIE CAST



CATALOG NUMBER	TRADE SIZE	INNER CARTON	MASTER CARTON
85001	3/8"	10	100
85002	1/2"	10	100
85003	3/4"	10	100
85004	1"	5	50
85005	1-1/4"	2	20
85006	1-1/2"	2	20
85007	2"	1	10
85008	2-1/2"	-	1
85009	3"	-	1
85011	4"	-	1

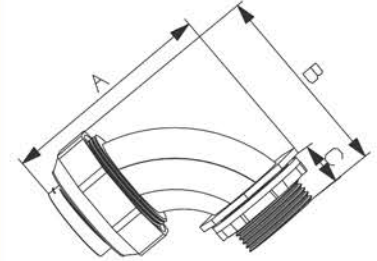

CAT#	A	B	C
85001	2.402	2.204	0.511
85002	2.433	2.153	0.511
85003	2.717	2.519	0.563
85004	3.425	2.885	0.720
85005	3.976	3.220	0.838
85006	4.122	3.700	0.708
85007	4.701	4.184	0.680
85008	6.189	5.149	1.043
85009	7.087	6.133	0.964
85011	8.531	7.405	1.027

LIQUID-TIGHT CONNECTORS - 90° ANGLE - INSULATION - ZINC DIE CAST



CATALOG NUMBER	TRADE SIZE	INNER CARTON	MASTER CARTON
85001-A	3/8"	10	100
85002-A	1/2"	10	100
85003-A	3/4"	10	100
85004-A	1"	5	50
85005-A	1-1/4"	2	20
85006-A	1-1/2"	2	20
85007-A	2"	1	10

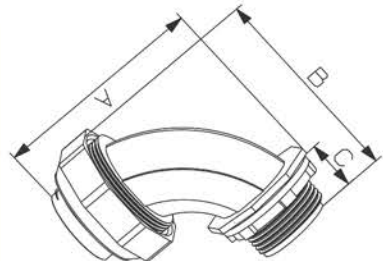

CAT#	A	B	C
85001-A	2.402	2.244	0.551
85002-A	2.433	2.193	0.551
85003-A	2.717	2.559	0.603
85004-A	3.425	2.925	0.760
85005-A	3.976	3.260	0.878
85006-A	4.122	3.740	0.748
85007-A	4.701	4.224	0.720

90° LIQUID-TIGHT CONNECETORS - NYLON



CATALOG NUMBER	TRADE SIZE	INNER CARTON	MASTER CARTON
P490	3/8"	-	-
P491	1/2"	10	100
P492	3/4"	10	100
P493	1"	5	50
P494	1-1/4"	-	-
P495	1-1/2"	-	-
P496	2"	-	-

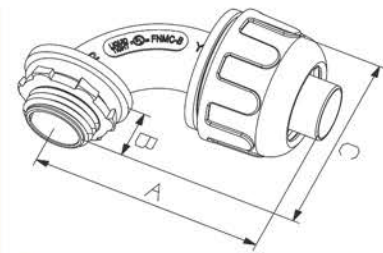

CAT#	A	B	C
P490	2.840	0.500	2.030
P491	2.840	0.500	2.030
P492	3.250	0.500	2.330
P493	3.540	0.600	2.950
P494	4.750	0.760	5.200
P495	4.750	0.800	5.200
P496	5.420	0.860	5.800

LIQUID - TIGHT CONNECTORS - STRAIGHT - ZINC DIE CAST

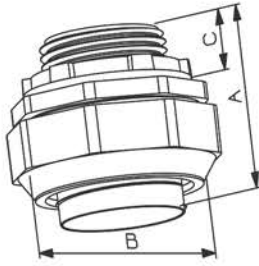

CAT#	A	B	C
88115	1.444	1.299	0.543
88116	1.444	1.307	0.551
88117	1.448	1.583	0.551
88118	1.810	1.780	0.716
88119	2.031	1.909	0.716
88120	1.991	2.488	0.716
88121	2.007	2.992	0.684
88122	3.279	3.709	0.984
88123	3.440	4.331	1.011
88124	5.470	3.660	0.920
88125	3.984	5.173	1.035

CATALOG NUMBER	TRADE SIZE	INNER CARTON	MASTER CARTON
88115	3/8"	20	200
88116	1/2"	20	200
88117	3/4"	10	100
88118	1"	5	50
88119	1-1/4"	5	50
88120	1-1/2"	2	20
88121	2"	2	20
88122	2-1/2"	1	10
88123	3"	1	10
88124	3-1/2"	-	1
88125	4"	-	1



LIQUID - TIGHT CONNECTORS - STRAIGHT WITH INSULATED THROAT - ZINC DIE CAST

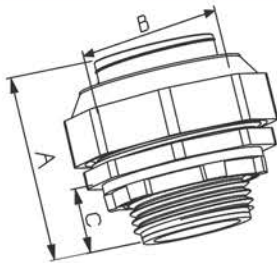

CAT#	A	B	C
88115-A	1.484	1.299	0.583
88116-A	1.484	1.307	0.591
88117-A	1.488	1.583	0.591
88118-A	1.850	1.780	0.756
88119-A	2.071	1.909	0.756
88120-A	2.031	2.488	0.756
88121-A	2.047	2.992	0.724

CATALOG NUMBER	TRADE SIZE	INNER CARTON	MASTER CARTON
88115-A	3/8"	20	200
88116-A	1/2"	20	200
88117-A	3/4"	10	100
88118-A	1"	5	50
88119-A	1-1/4"	5	50
88120-A	1-1/2"	2	20
88121-A	2"	2	20



LIQUID - TIGHT CONNECTORS - NYLON

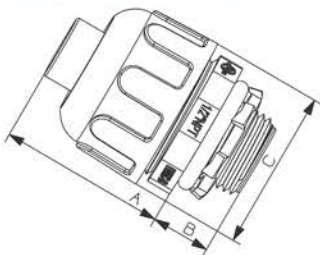

CAT#	A	B	C
P470	1.180	0.550	1.420
P471	1.180	0.550	1.420
P472	1.200	0.640	1.690
P473	1.230	0.720	2.020
P474	2.440	0.760	2.400
P475	2.700	0.800	2.670
P476	2.990	0.850	3.280

CATALOG NUMBER	TRADE SIZE	INNER CARTON	MASTER CARTON
P470	3/8"	20	200
P471	1/2"	20	200
P472	3/4"	10	100
P473	1"	5	50
P474	1-1/4"	-	50
P475	1-1/2"	-	50
P476	2"	-	20



FLEX & NM & SE



FLEXIBLE METAL CONDUIT SQUEEZE CONNECTOR - ZINC DIE CAST



E315258 3/8" - 3/4"
E315256 1" - 4"

CATALOG NUMBER	TRADE SIZE	INNER CARTON	MASTER CARTON
82059	3/8"	50	500
82060	1/2"	25	250
82061	3/4"	25	250
82062	1"	10	100
82063	1-1/4"	10	100
82064	1-1/2"	5	50
82065	2"	10	40
82066	2-1/2"	-	10
82067	3"	-	10
82068	3-1/2"	-	1
82069	4"	-	1

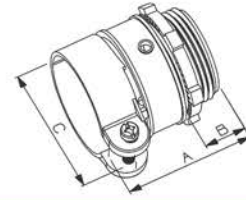

CAT#	A	B	C
82059	1.146	0.512	1.141
82060	1.437	0.492	1.370
82061	1.575	0.476	1.574
82062	1.760	0.571	1.866
82063	1.874	0.587	2.145
82064	2.008	0.610	2.519
82065	2.087	0.606	3.011
82066	2.854	0.866	3.866
82067	2.236	0.866	4.354
82068	3.840	0.902	4.788
82069	4.055	0.902	5.303

FLEXIBLE METAL CONDUIT SQUEEZE CONNECTOR WITH INSULATED THROAT - ZINC DIE CAST



E315258 3/8" - 3/4"
E315256 1" - 4"

CATALOG NUMBER	TRADE SIZE	INNER CARTON	MASTER CARTON
82060-A	1/2"	25	250
82061-A	3/4"	25	250
82062-A	1"	10	100
82063-A	1-1/4"	10	100
82064-A	1-1/2"	5	50
82065-A	2"	10	40



CAT#	A	B	C
82060-A	1.497	0.552	1.370
82061-A	1.635	0.536	1.574
82062-A	1.820	0.631	1.866
82063-A	1.954	0.667	2.145
82064-A	2.934	0.690	2.519
82065-A	2.167	0.686	3.011

DUPLEX CONNECTORS - ZINC DIE CAST



E315258

CATALOG NUMBER	TRADE SIZE	INNER CARTON	MASTER CARTON
84001	3/8"	50	500

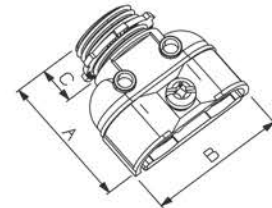

CAT#	A	B	C
84001	1.591	1.622	0.457

DUPLEX CONNECTORS - ONE SCREW - ZINC DIE CAST



E315258

CATALOG NUMBER	TRADE SIZE	INNER CARTON	MASTER CARTON
84002	3/8"	25	250

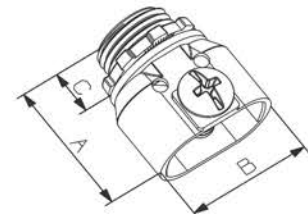

CAT#	A	B	C
84002	1.402	1.323	0.472

FLEX CONNECTORS - SCREW IN - ZINC DIE CAST

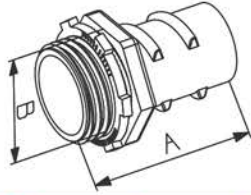

CATALOG NUMBER	TRADE SIZE	INNER CARTON	MASTER CARTON
83013	3/8"	50	500
83014	1/2"	50	500
83015	3/4"	50	500
83016	1"	25	250



CAT#	A	B
83013	1.303	0.906
83014	1.366	0.913
83015	1.614	1.126
83016	1.925	1.366



FLEX CONNECTORS - SCREW IN - ZINC DIE CAST

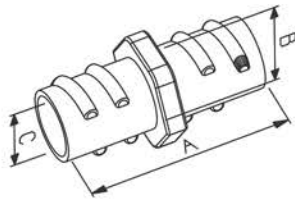

CATALOG NUMBER	TRADE SIZE	INNER CARTON	MASTER CARTON
83031	1/2"	25	250
83032	3/4"	25	250



CAT#	A	B	C
83031	1.811	0.906	0.540
83032	2.051	1.197	0.738



FLEXIBLE METAL CONDUIT 90° SQUEEZE CONNECTOR - ZINC DIE CAST



E315258 3/8" - 3/4"
E315256 1" - 4"

CATALOG NUMBER	TRADE SIDE	INNER CARTON	MASTER CARTON
84022	3/8"	50	500
84023	1/2"	25	250
84024	3/4"	10	100
84025	1"	5	50
84026	1-1/4"	10	40
84027	1-1/2"	-	5
84028	2"	-	5
84029	2-1/2"	-	5
84030	3"	-	2
84032	4"	-	1

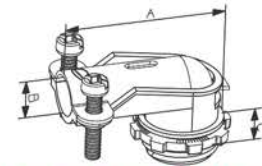

CAT#	A	B(MIN)	B(MAX)	C
84022	1.752	0.430	0.720	0.350
84023	2.122	0.640	1.030	0.350
84024	2.346	0.760	1.150	0.440
84025	2.768	1.090	1.730	0.543
84026	3.890	1.340	1.970	0.594
84027	6.008	1.650	2.610	0.689
84028	6.008	1.540	2.540	0.701
84029	6.795	2.450	2.980	0.843
84030	7.886	2.930	3.450	0.827
84032	9.783	3.680	4.430	0.941

FLEXIBLE METAL CONDUIT 90° SQUEEZE CONNECTOR - WITH INSULATED THROAT - ZINC DIE CAST



E315258 3/8" - 3/4"
E315256 1" - 4"

CATALOG NUMBER	TRADE SIZE	INNER CARTON	MASTER CARTON
84022-A	3/8"	50	500
84023-A	1/2"	25	250
84024-A	3/4"	10	100
84025-A	1"	5	50
84026-A	1-1/4"	10	40
84027-A	1-1/2"	-	5
84028-A	2"	-	5

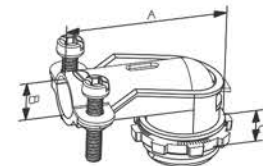

CAT#	A	B(MIN)	B(MAX)	C
84022-A	1.811	0.430	0.720	0.409
84023-A	2.181	0.640	1.030	0.409
84024-A	2.405	0.760	1.150	0.499
84025-A	2.827	1.090	1.730	0.602
84026-A	2.848	1.340	1.970	0.674
84027-A	6.088	1.650	2.610	0.769
84028-A	6.088	1.540	2.540	0.781

CABLE CONNECTORS STEEL CLAMP - ZINC DIE CAST



E315257

CATALOG NUMBER	TRADE SIZE	INNER CARTON	MASTER CARTON
88019	3/8"	100	1000
88024	3/4"	50	500
88024	3/4"	25	250
88025	1"	25	250
88026	1-1/4"	10	100
88027	1-1/2"	10	100
88028	2"	5	50

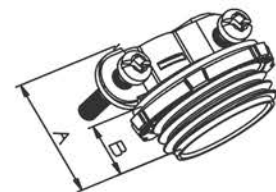

CAT#	A	B
88019	0.783	0.354
88024	0.925	0.409
88024	0.925	0.409
88025	1.086	0.503
88026	1.251	0.598
88027	1.440	0.606
88028	1.577	0.769

CABLE CONNECTORS - ZINC DIE CAST

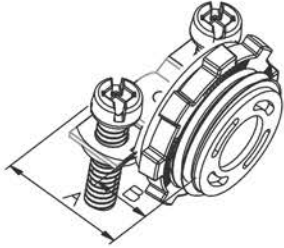

CAT#	A	B
88003	0.783	0.354

CATALOG NUMBER	TRADE SIZE	INNER CARTON	MASTER CARTON
88003	3/8"	100	1000



SET SCREW BX CONNECTORS - ZINC DIE CAST

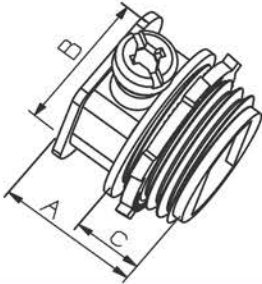

CAT#	A	B	C
88201	0.780	0.877	0.386

CATALOG NUMBER	TRADE SIZE	INNER CARTON	MASTER CARTON
88201	3/8"	100	1000



PLASTIC INSULATING BUSHINGS

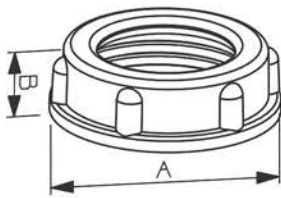

CAT#	A	B
33001	1.051	0.362
33002	1.283	0.386
33003	1.618	0.480
33004	1.902	0.567
33005	2.295	0.476
33006	2.630	0.531
33007	3.236	0.614
33008	3.911	0.677
33009	4.307	0.709
33010	4.810	0.722

CATALOG NUMBER	TRADE SIZE	INNER CARTON	MASTER CARTON
33001	1/2"	100	1000
33002	3/4"	100	1000
33003	1"	50	500
33004	1 1/4"	25	250
33005	1 1/2"	25	250
33006	2"	25	100
33007	2 1/2"	10	100
33008	3"	10	100
33009	3 1/2"	-	20
33010	4"	-	20



E315256 1/2"-4"
E358603 3 1/2",5",6"

2-PIECE CONNECTERS - STEEL

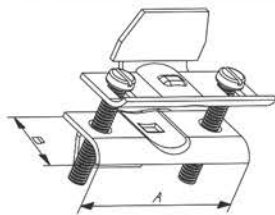

CATALOG NUMBER	TRADE SIZE	INNER CARTON	MASTER CARTON
65001	3/8"-1/2"	50	500
65002	3/4"-1"	25	250



CAT#	A	B
65001	1.310	0.640
65002	1.750	0.765



KNOCK - OUT SEALS - STEEL



CATALOG NUMBER	TRADE SIZE	INNER CARTON	MASTER CARTON
63001	1/2"	100	1000
63002	3/4"	50	500
63003	1"	50	500
63004	1 1/4"	50	500
63005	1 1/2"	30	300
63006	2"	20	200

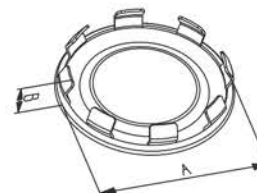

CAT#	A	B
63001	1.079	0.315
63002	1.250	0.313
63003	1.500	0.344
63004	1.898	0.346
63005	2.219	0.359
63006	2.688	0.375

NAIL PLATES - STEEL - ZINC



CATALOG NUMBER	TRADE SIZE	INNER CARTON	MASTER CARTON
65501	1 1/2" x 2 1/2"	-	100
65501	1 1/2" x 2 1/2"	-	200
65501	1 1/2" x 2 1/2"	50	200

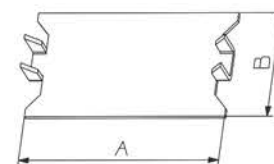

CAT#	A	B
65501	2.500	1.500
65501	2.500	1.500
65501	2.500	1.500

SERVICE ENTRANCE CAPS - THREADED - ALUMINUM

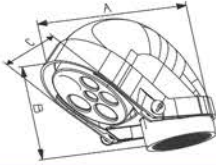

CAT#	A	B	C
70001	2.945	2.346	1.996
70002	3.395	2.504	2.244
70003	3.855	2.972	2.523
70004	4.430	3.358	2.968
70005	5.620	3.972	3.456
70006	7.118	5.106	4.543

CATALOG NUMBER	TRADE SIZE	INNER CARTON	MASTER CARTON
70001	1/2"	30	120
70002	3/4"	20	80
70003	1"	10	40
70004	1 1/4"	8	32
70005	1 1/2"	4	16
70006	2"	2	8



E358603

SERVICE ENTRANCE CAPS - CLAMP - ALUMINUM

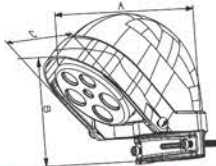

CAT#	A	B	C
71001	3.362	2.543	1.996
71002	3.746	2.890	2.244
71003	4.180	3.346	2.523
71004	4.772	3.634	2.968
71005	5.938	4.496	3.456
71006	7.811	5.807	4.543

CATALOG NUMBER	TRADE SIZE	INNER CARTON	MASTER CARTON
71001	1/2"	30	120
71002	3/4"	20	80
71003	1"	10	40
71004	1 1/4"	8	32
71005	1 1/2"	4	16
71006	2"	2	8



E358603

ROOF FLASHINGS - STEEL

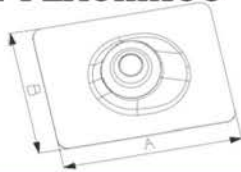

CAT#	A	B
66691	12.44	8.72
66692	12.44	8.72
66693	14.500	10.750
66694	14.500	10.750

CATALOG NUMBER	TRADE SIZE	INNER CARTON	MASTER CARTON
66691	1/2"-1"	-	10
66692	1 1/4"	-	20
66693	2"	-	20
66694	2-1/2"	-	20



BARE WIRE GROUND CLAMPS - ZINC DIE CAST

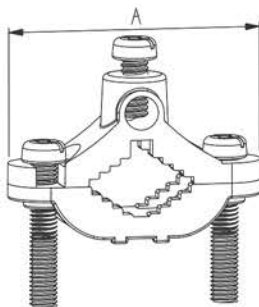

CAT#	A
86003	2.203

CATALOG NUMBER	TRADE SIZE	INNER CARTON	MASTER CARTON
86003	FROM 1/2" THRU 1"	25	50



E356513



DOOR CHIME



DESCRIPTION

Don't miss a beat when someone's at the door! Our door chime kits, whether single or double gang, has you covered. They come with hardwired push buttons (UL-listed, of course) and throw in a 10VA transformer in the mix.

COMMON TECHNICAL DATA

Size	Covers single gang box
Cover Material	HPS white plastic
Mounting Screws	2 base screws, 4 push button screws
Chime Front Door	2-note
Tone Bar Material	Steel, painted black
Sound Level	dB >= 80db*
Certification	ULus
Buttons	Hardwired push buttons
Doorbell Wiring Maximum	20AWG
Transformer Type	10VA transformer
Transformer Wattage	10W
Transformer Voltage	16V

*Decibel level measured on "A" scale at 3 feet

Part No.

L1-2303-N one button, door chime kit, non-light buttons

L2-2303-N two button, door chime kit, non-light buttons

L1-2303 one button, door chime kit, light button

L2-2303 two button, door chime kit, light button

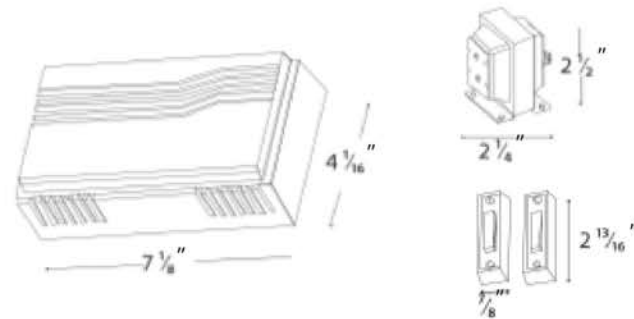

CERTIFICATION



APPLICATION AND PERFORMANCE SPECIFICATION INFORMATION IS SUBJECT TO CHANGE WITHOUT NOTIFICATION



