



# Wireless Light Switch Kit

[Instruction Manual]



Please pay attention to the warning signs  
Read the instructions with caution before operating  
and keep it properly

## Warning:

**To reduce the risk of fire, electric shock, or personal injury, please strictly follow the instructions.**

1. Indoor use only. Avoid high humidity, high temperature, and areas with a high magnetic field.
2. Always be sure to cut off the power before installing the receiver.
3. Don't connect any device that may exceed the performance limits of the receiver.
4. Don't install or repair the product Only authorized service personnel should undertake such installation and repairs.
5. If the remote is not in use for an extended period time, remove batteries.
6. Used batteries should be disposed of safely and properly.
7. To prevent a choking hazard, keep packing materials away from children.
8. Do not use the battery again if it is dropped or knocked out of shape.

## Product Layout

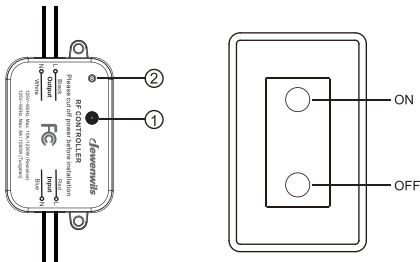

- ① Program button (On/Off button)
- ② Indicator

## Wiring Diagram

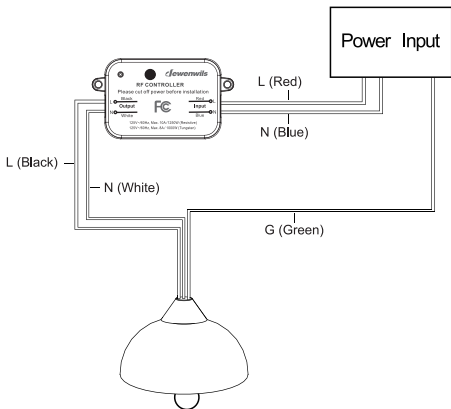

1. Turn off the power to the main circuit breaker or fuse box working area before installation.
2. At the input "L" Red line is the hot wire, "N" Blue line is the neutral wire. At the output "L" Black line is the hot wire, "N" White line is the neutral wire. Do not connect the "L" (hot wire) and "N" (neutral wire) mistakenly.
3. Connect the power to the "input" side, and the load to the "output" side carefully.
4. The wireless switch kit only needs to connect with the hot wire and neutral wire. The "G" Green line (ground wire) just needs to be connected as normal.
5. After connecting, use the wiring cap to cover it.

## Operating Instructions

1. Remove the isolation tab in the battery compartment of the transmitter.
2. Press the ON/OFF button on the wall switch remote control to turn the receiver on and off.

Note:

1. The program button of the receiver can also be used as a manual switch.
2. The receiver will remain "OFF" after a power cut to save energy.

## Mounting the Wall Switch

Shown as the figure

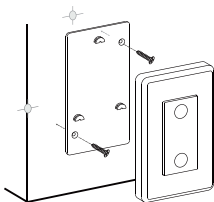

## Canceling Programming

To remove a receiver from all transmitter pairings (no remote transmitter can control it):

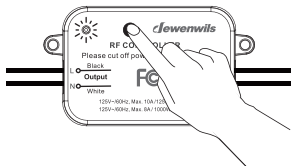

1. Press the program button on the receiver for 6 seconds until the indicator light starts to flash rapidly. (Note: The light flashes from slowly to rapidly.)

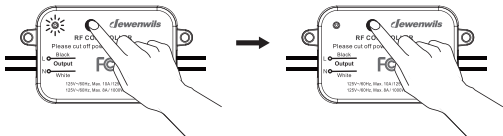

2. Release the program button and then press it again. The indicator light will be off. All the programming has been canceled.

## Programming the Receiver

The receivers and transmitters have been pre-paired for immediately use, but there are few units may not be pre-programmed or programmed incorrectly, or you want to customize the configuration to meet your needs.

To program a transmitter and receiver, please follow the steps below:

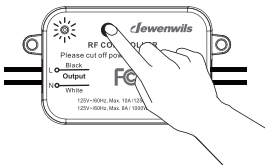

1. Press the program button on the receiver for 3 seconds until the indicator light starts to flash slowly.

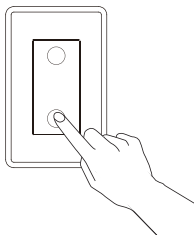

2. Release the program button and then press the “on” or “off” button on the remote control.

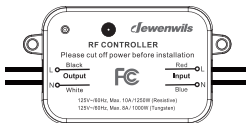

3. Programming / pairing is successful when the indicator light stops blinking.

Note:

Each set of ON or OFF button can be paired with and control several receivers;  
Each receiver can be paired and controlled by multiple transmitters.

## Battery Replacement

1. If you find the receiver is working abnormally or the indicator on the transmitter becomes dim, replace the remote battery with a new DC 12V (type 23A) battery, making sure the polarity +/- of the battery is correct.
2. Low battery power may decrease readable wireless remote range.

3. Remove batteries if the remote is not in use for an extended period of time.

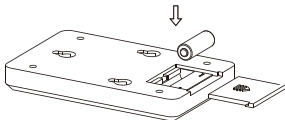

## Troubleshooting

In the case that one receiver is unresponsive to the remote control, please follow the steps below to resolve the issue:

1. If the wire switch receiver is unresponsive to the remote control, please refer to the "Canceling Programming" and "Programming the Receiver" sections in the manual to reprogram the receiver.
2. Make sure the receiver and appliance are properly connected and powered on.
3. Replace the remote battery with a new 12V (23A) battery.
4. The remote transmitter may be too far away to control the receiver.
5. Make sure not to exceed the maximum load.
6. "Canceling Program" is always prior to "Programming the Receiver" when you would like to make changes.

## Specifications

- Input Voltage: 120VAC, 60Hz
- Max Power Rating: 1000W Tungsten  
600W Fluorescent  
200W LED Lamp
- Transmission Frequency: 433.92MHz
- Remote Battery: 23A, 12V
- Remote Distance: 100ft (Free Area)

## Safety Information

**Federal Communications Commission Interference Statement.** This equipment has been tested and found to comply with the limits for Class B digital device, pursuant to part 15 of the FCC Rules. These limits are designed to provide reasonable protection against harmful interference in a residential installation. This equipment generates, uses and can radiate radio frequency energy and, if not installed and used in accordance with the instructions, may cause harmful interference to radio or television reception, which can be determined by turning the equipment off and on, the user is encouraged to try to correct the interference by one or more of the following measures:

- Redirect or relocate the receiving antenna.
- Increase distance between the equipment and the receiver.
- Connect the equipment into an outlet on a circuit different from that to which the receiver is connected.
- Consult the dealer or an experienced radio/TV technician for help.

This device complies with Part 15 of the FCC Rules. Operation is subject to the following two conditions:

(1) this device may not cause interference, and (2) this device must accept any interference, including interference that may cause undesired operation of the device.

**FCC Caution:** Any changes or modifications not expressly approved by the party responsible for compliance could void the user's authority to operate this equipment.

## ISED Warning:

This device complies with Innovation, Science, and Economic Development Canada licence-exempt RSS standard(s). Operation is subject to the following two conditions:

- (1) this device may not cause interference, and
- (2) this device must accept any interference, including interference that may cause undesired operation of the device.



Le présent appareil est conforme aux CNR d' Innovation, Sciences et Développement économique Canada applicables aux appareils radio exempts de licence. L'exploitation est autorisée aux deux conditions suivantes :

- (1) l'appareil ne doit pas produire de brouillage, et
- (2) l'utilisateur de l'appareil doit accepter tout brouillage radioélectrique subi, même si le brouillage est susceptible d'en compromettre le fonctionnement.

The device is compliance with RF exposure guidelines, users can obtain Canadian information on RF exposure and compliance.

Le présent appareil est conforme

Après examen de ce matériel aux conformité ou aux limites d'intensité de champ RF, les utilisateurs peuvent sur l'exposition aux radiofréquences et la conformité and compliance d'acquérir les informations correspondantes.

## **One Year Limited Warranty**

Supported by our professional R&D team and QC team, we provide One Year Warranty for materials and workmanship from the purchase date. Please note that the warranty does not cover damage caused by personal misuse or improper installation.

Please attach your Order ID and Name so that our dedicated customer service team can help you better.

