

Jewenwils

Four-Zone Automatic Water Timer

SKU: HDWT04B
[Instruction Manual]

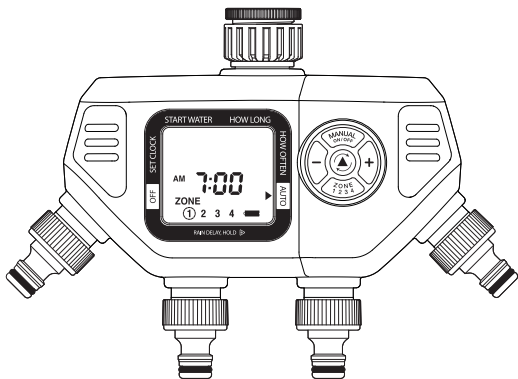

Please pay attention to the warning signs
Read the instructions with caution before operating
and keep it properly

V20914

Warning:

- Do not use for industrial purposes or in conjunction with chemicals, foodstuffs and explosive materials.
- Only use clear fresh water.
- Do not pull the hose connected to the Water Timer.
- Children are not allowed to use the water timer without supervision.
- When expecting freezing temperatures, timers should be removed from the hose faucet and stored indoors to avoid potential freeze damage.
- Do not disassemble or repair the product, but only by authorized service personnel.

Product Layout

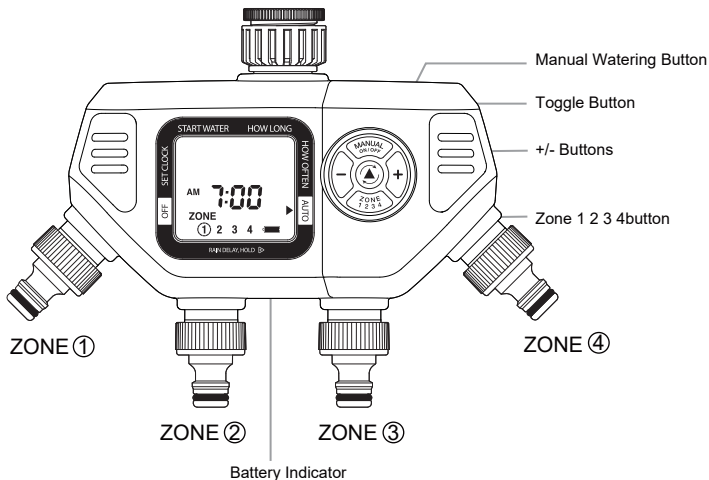

Battery Installation

Install 2AA Alkaline batteries by removing the battery holder from the back of the water timer and insert the battery as indicated. Replace the battery holder, making sure that is firmly and securely placed in the water timer.

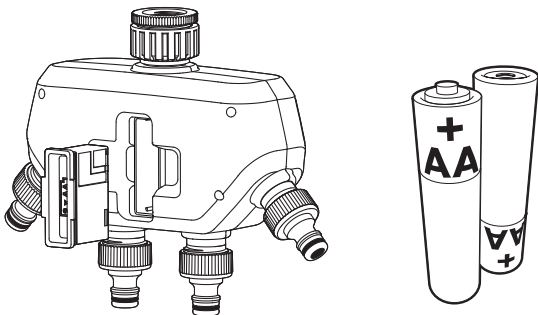

We recommend replacing batteries when the indicator reaches



Note:

1. In order to stop the water timer from failing because of a weak battery, if you are away for a long time, the battery must be replaced when the battery still shows "LOW".
2. Do not dispose of batteries in fire. Batteries may explode or leak.

Installation

step1

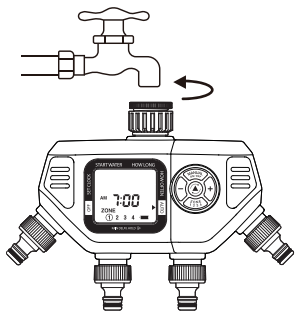

step2

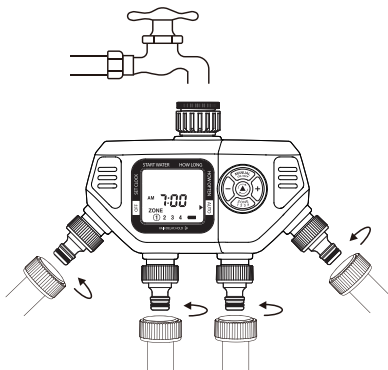

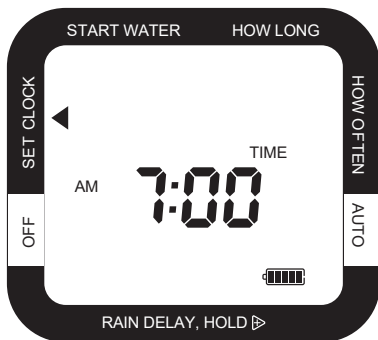

Setting The Clock

1. Press the Cursor Button (⤴) to move the Arrow Pointing ◀ to SET CLOCK.
2. Press the ◀ & ▶ buttons to adjust the clock to the current time.
3. Press the Cursor Button (⤴) again to set the time and move to the next setting, Start Water.



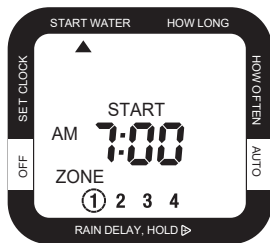
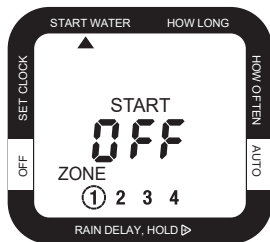

Select When To Water

1. With the arrow pointing to Start Water, use the ◀ & ▶ buttons to select the first time of the day you want to water. All remaining watering cycles during the day will be based on this time.
2. Press ZONE  to change the zone. You must first enter a start time for each zone you are programming before any other settings for a zone.
3. Press the Cursor Button  to move to the next setting.





Select How Long To Water

1. With the arrow pointing to How Long use the ◀ & ▶ buttons to select the length of each watering cycle. Cycles can be up to 360 minutes (6 hours) in duration.

2. Press ZONE  to change the zone. You must set How Long for each zone you are programming before proceeding.
3. Press the Cursor Button  to move to the next setting.







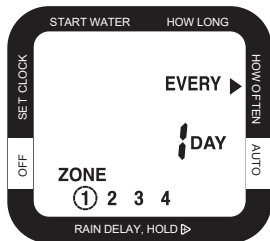

Select How Often To Water







1. With the arrow pointing to How Often use the ◀ & ▶ buttons to select the watering frequency.
2. You will be able to water as often as every 1 hour, every day or as infrequently as once every 7 days.
3. Press ZONE  to change the zone or the Cursor Button  to move to the next setting. You must set How Often for each zone you are programming before proceeding.



EVERY 1 DAY

	SUNDAY	MONDAY	TUESDAY	WEDNESDAY	THURSDAY	FRIDAY	SATURDAY
EVERY WEEK							

EVERY 2 DAY

	SUNDAY	MONDAY	TUESDAY	WEDNESDAY	THURSDAY	FRIDAY	SATURDAY
EVERY ONE WEEK							
EVERY TWO WEEK							



Auto Mode

1. After programming, the timer will be in Auto mode.
2. If the timer is not in Auto mode, press the Cursor Button  to switch to Auto.
3. The screen display will alternate between the current TIME and the NEXT START TIME for each zone. This will allow you to see at a glance what will happen next.
4. If the next watering cycle is more than 24 hours away, the NEXT START TIME will be displayed in days instead showing a time.





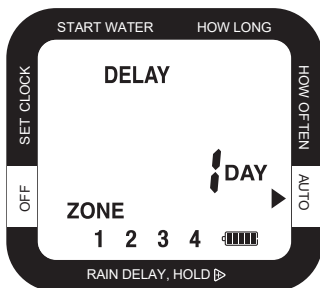

Rain Delay Mode

1. If there is rain in the forecast and you wish to temporarily stop watering, you can use Rain Delay.
2. Rain Delay Mode will stop all watering for up to 7 days.
3. After the delay period, the watering program will begin running automatically.
4. To activate Rain Delay Mode, make certain the arrow is pointing to AUTO. Hold the key  for 3 secs, then select the delay period. You can reduce the delay period with the  key.
5. In Rain Delay Mode, the screen will toggle between the current TIME and the remaining DELAY time. If the delay is greater than 12 hours, the DELAY will be shown in DAYS.





Off Mode

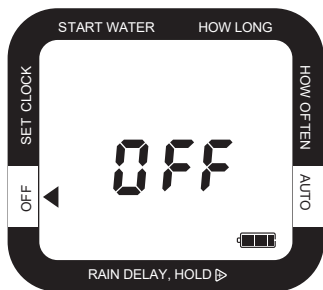



1. If you wish to stop watering for an extended period, push the Cursor Button  until the arrow is pointing to OFF. The timer will not water automatically while in this mode. The screen will display the word OFF in large letters.
2. To start watering automatically again, simply press the Cursor Button  until the arrow is pointing to AUTO. The program will begin watering at the next available Start Time.



Note:

Setting the timer to OFF disables all watering zones. In order to disable a specific zone (or zones), use the Cursor Button  to move to HOW LONG. Ensure you are adjusting the desired watering zone by using the ZONE  button. Adjust the HOW LONG setting to "0". To reactivate the zone, adjust the HOW LONG setting back to the desired watering duration.

Manual Watering

1. Press Manual On/Off , then the manual mode will start.
2. Press ZONE  to select the zone you want to open. Then press the  or  button to adjust the amount of time you want the valve to be open.

3. The valve will open after a few seconds and automatically close after the selected time.



NOTE:

The manual mode of both zones cannot be activated as long as any of zone is open.

Timer Reset

1. If you need to completely erase all settings in the timer and return it to its original state, press and hold the Cursor Button for 7 seconds.
2. The screen will display RESET to confirm the action.

NOTE: All programming will be lost when the timer is RESET.

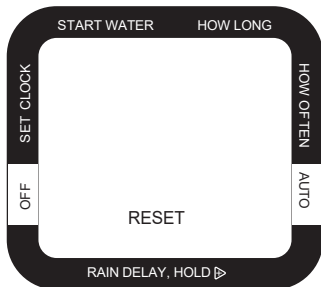

Useful Tips

● BATTERY LIFE

- Only use fresh long lasting alkaline batteries
- Do not use rechargeable batteries
- Turn off the unit when not in use
- Remove the batteries before storage
- Moisture sensor uses more energy
- Frequently watering schedules can cause the batteries to drain faster



● CLEANING YOUR TIMER

Your timer should be cleaned periodically. From time to time, you may get sediment or dirt build-up in your timer. Follow the information below.

- 1) Turn off your water faucet. Remove the timer from the faucet connection and your hose connections. Look at the filter washer at the faucet connection input. Check that the filter washer is clear of any built-up sediment.
- 2) If the filter is dirty, remove the filter washer from the timer. Clean out the filter washer by placing it under running water.

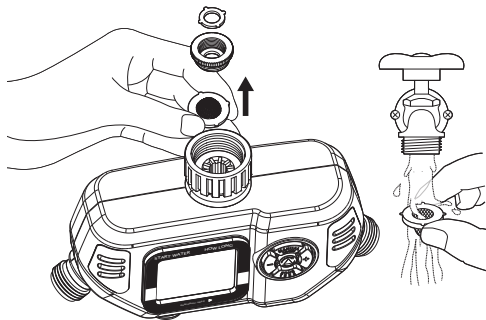

- 3) Turn the timer upside down and activate the MANUAL mode. This will open up the valves and allow you to run water into the output connectors. By doing this, you can see if there are any clogs in the water flow. Once you see the water flow is correct, deactivate the MANUAL mode.

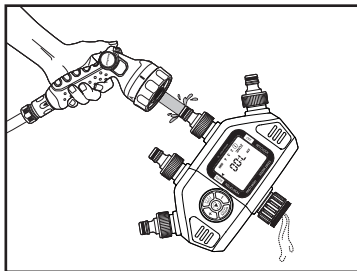
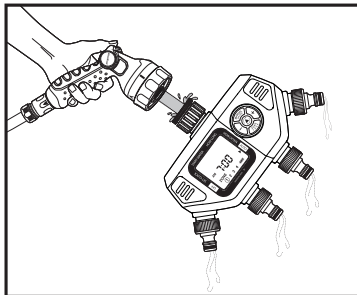

● SEASONAL STORAGE

Cold or freezing temperatures can damage to the timer if still connected to the faucet. At the first forecast of frost, it is best to remove the timer from the faucet and place the timer indoors. (Cold water, if left in the timer, will damage the timer from the ice formed).

- Remove the batteries when the timer is placed in storage
- Recycle used batteries, do not dispose in the garbage

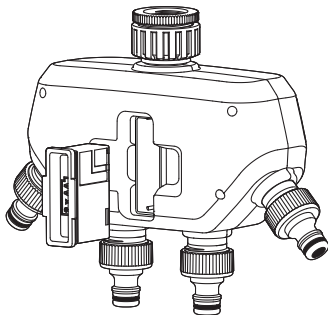

Specifications

- Watering Duration: 1min-360min
- Max. Water Pressure: 120 psi
- Battery: 2 x AA batteries (not included)

Packing List

- Water Hose Timer x 1
- Instruction Manual x 1

One Year Limited Warranty

Supported by our professional R&D team and QC team, we provide One Year Warranty for materials and workmanship from the purchase date. Please note that the warranty does not cover damage caused by personal misuse or improper installation.

Please attach your Order ID and Name so that our dedicated customer service team can help you better.