



SPA 1000TL BL
SPA 2000TL BL
SPA 3000TL BL

Installation & Operation Manual



Download
Manual



Growatt New Energy

Shenzhen Growatt New Energy Technology CO.,LTD
No.28 Guangming Road, Shiyan Street, Bao'an District,
Shenzhen, P.R.China

T +86 0755 2747 1942

E service@ginverter.com

W www.ginverter.com

GR-UM-152-A-00

List

1 Introduction

- 1.1 Overview
- 1.2 Target Group

2 Safety

- 2.1 Safety Overview
- 2.2 Symbols Explanation

3 Product Introduction

- 3.1 Function
- 3.2 Models
- 3.3 Appearance
- 3.4 Dimensions
- 3.5 Nameplate
- 3.6 Storage

4 Unpacking

5 Installation

- 5.1 Basic Installation Requirements
- 5.2 Tools and Instructions
- 5.3 Installation Instructions
- 5.4 System Connection Model

6 Commissioning

- 6.1 Commissioning of SPA
- 6.2 Operation Modes
- 6.3 Country Setting
- 6.4 Display and Button
- 6.5 Communication

7 Start-up and Shut Down SPA System

- 7.1 Start-up the SPA System
- 7.2 Disconnect the SPA System

8 Attention of the Installation

9 Trouble Shooting

10 EU Declaration of Conformity

11 Warranty

12 Decommissioning

- 12.1 Dismantling the Energy Storage
- 12.2 Packing the SPA Inverter
- 12.3 Storing SPA Inverter
- 12.4 Disposing of the SPA Inverter

13 Product Specification

- 13.1 SPA Series Energy Storage
Machine Product Specification
- 13.2 Torque
- 13.3 Appendix

14 Contact

1 Introduction

1.1 Overview

This manual will provide detailed product information and installation instructions for users of the SPA series of AC coupled from Shenzhen Gowatt New Energy Technology Co.Ltd. (hereinafter referred to as Gowatt). Please read this manual carefully before using this product, and keep this manual in a place that is easy for installation, operation, and maintenance personnel to obtain.

Any changes to this manual by Gowatt will not be notified to the user. You may refer to the Gowatt website (www.ginverter.com) for the most updated version.

1.2 Target Group

SPA must be installed by a professional electrician who is qualified for the relevant part of the certification. By reading this manual in detail, the installer can install the SPA series correctly and quickly, and can perform troubleshooting and communication system construction.

If there are any problems during the installation process, the installer can log on to www.ginverter.com to leave a message or call customer service hotline +86 0755 27471 942.

2 Safety



2.1 Safety Overview

- Please read this manual carefully before installation. If the equipment is damaged due to failure to install according to the instructions in this manual, Gowatt reserves the right not to guarantee the quality.
- All operations and wiring must be performed by trained and professional electrical technicians.
- When installing, do not touch the other parts of the inside of the chassis except the terminal block.
- All electrical connections must comply with local electrical safety standards.
- If the equipment requires maintenance, please contact the local designated system installation and maintenance personnel.
- The use of equipment for grid connection requires permission from the local power supply department.



Handling :

 WARNING	<ul style="list-style-type: none"> •SPA is heavy, please be careful to carry it out to prevent it from falling off.
---	--



Installation:

 CAUTION	<p>Please read this manual carefully before installation. If the equipment is not damaged according to the instructions in this manual, Gowatt reserves the right not to guarantee the quality.</p>
 DANGER	<p>Before proceeding with the installation, make sure that the SPA does not have any electrical connections.</p>
 WARNING	<ul style="list-style-type: none"> •Please refer to the contents of this manual for the installation environment, spacing, etc. •Install the SPA in a dry and ventilated position, otherwise the SPA may be affected. •Please refer to this manual for the installation procedure. Please read it carefully before installation.

Electrical connections:



 DANGER	<ul style="list-style-type: none"> •Must be operated by a trained professional electrical technician and follow this manual and local regulations. •Do not touch the inverter at will because of high voltage danger. •Do not place flammable or explosive materials around the SPA.
 WARNING	<ul style="list-style-type: none"> •An AC circuit breaker must be installed for each SPA, and multiple SPA are prohibited from sharing. •The cable is thick. Do not shake it tightly after tightening the cable terminals. Make sure that the terminals are well connected before starting SPA. In case the terminal is loose, it will cause overheating damage. •Please confirm the positive and negative poles before connecting the battery to the SPA.

Repair and replacement:

 DANGER	<ul style="list-style-type: none"> •It must be operated by a trained professional electrical technician and adhere to this manual. •Be sure to disconnect the battery and Grid for at least 5 minutes before operation to avoid danger. Please perform all operations after power off. •Risk of high voltage, be careful of electric shock.
 WARNING	<p>For inverters that are no longer in operation in the future, users need to properly dispose of them.</p>

Product Introduction 3

2.2 Symbols explanation

Symbol	Description
	Danger of high voltage and electrical shock.
	Danger of hot surface. SPA will become hot during operation to avoid contact during operation.
	Caution: Risk of danger. Caution: Risk of danger.
	Danger of high voltage There is residual voltage existing in SPA after turned off, please wait at least 5 minutes before you open the upper lid or the DC lid.
	Connecting the protective earth (PE) cable.
	Remind operators refer to the documents supplied with SPA.
	SPA should not be disposed as household waste.
	Keep dry! The package /product must be protected from excessive humidity and be stored under cover.
	CE Mark. SPA complies with the requirements of the applicable CE guidelines.

3.1 Function

SPA series are the AC Coupled inverter which can store energy into battery with or without existing grid-tied inverter system. SPA can be used to optimize self-consumption, stored in the battery or feed into public grid. It also can provide power for emergency use during the grid lost by using the energy from the battery.

3.2 Models

This document involves the following product model:

- SPA 1000TL BL
- SPA 2000TL BL
- SPA 3000TL BL

Table 3.1 Designation explanation of the SPA series.

- Series name •SPA-Single Phase AC Coupled inverter.
Power level •1000TL-the power level is 1kW.
•2000TL-the power level is 2kW.
•3000TL-the power level is 3kW.

- Battery •BL-be used with low voltage battery.

3.3 Appearance

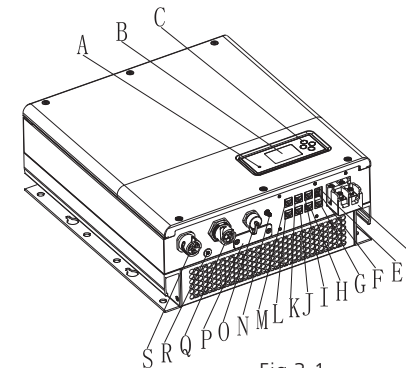

Fig 3.1

Position	Description
A	LED of status display
B	LCD screen
C	Function button
D	Battery terminal
E	DIP switch (set safety standard)

F	Dry Contact
G	RS 485 communication interface of Lithium battery
H	CAN communication interface of Lithium battery
I	METER input terminal
J	NTC:Lead-acid temperature sensor terminal
K	CT 2(CT terminal use for measure other inverter power)
L	RJ 45 interface of DRMs(used only in Australia)
M	CT 1(CT terminal use for measure grid power)
N	ANTENNA
O	USB interface
P	RS 232 interface
Q	EPS output(off grid connection)
R	Ground Point
S	AC Grid (on grid connection)

Table 3.1

3.4 Dimensions

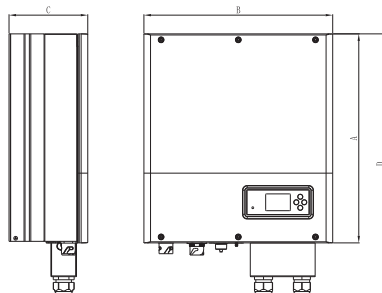

Fig 3.2

Dimensions	A(mm)	B(mm)	C(mm)	D(mm)	Weight(kg)
SPA Series	474	428	178	590	18.6

Table 3.2

3.5 Nameplate

Nameplate contains the following information. Take SPA3000 as an example:

Growatt AC Coupled Inverter	
Model name	SPA 3000TL BL
AC output data	
Nominal power	3000 W
Max. apparent power	3000 VA
Nominal voltage	230 a.c.V
Max. current	16 a.c.A
Nominal Frequency	50/60 Hz
Power factor range	0.8leading-0.8lagging
Stand alone data	
Nominal AC output power	3000 W
Nominal AC output voltage	230 a.c.V
Nominal AC output Frequency	50/60 Hz
Battery data	
Battery voltage range	42-59 d.c.V
Max. charging and discharging current	66 d.c.A
Type of battery	Lithium / Lead-acid
Others	
Safety level	Class I
Ingress Protection	IP65
Operation Ambient Temperature	-25~60°C
VDE0126-1-1, IEC62040, VDE-AR-N4105, AS4777.2, IEC62116, IEC61727, UTE C 15-712, EN 50438, G98, CEI 0-21, IEC62477	

Fig 3.3

3.6 Storage

- The SPA Series is best stored in the original packaging and placed in a ventilated and dry place.
- The stored temperature range is -25 ° C - +60 ° C, storage humidity range is 0 ~ 95%.
- If a large number of SPA Series need to be stored, do not exceed seven layers.
- Long-term SPA Series need to be tested before installation.

	<p>After the storage time exceeds one month, the time and date of the factory setting of the SPA Series may be incorrect. Before the SPA Series is connected to the grid, the related settings need to be made. For the specific setting method, please refer to 6.4.3 to set the time and date of the SPA Series.</p>
--	--

4 Unpacking

Please check whether external damage to the goods before unpacking. After unpacking, Please check whether the unit damage or missing parts, If it is happen, Please contact with supplier.

SPA series and accessories as follows:

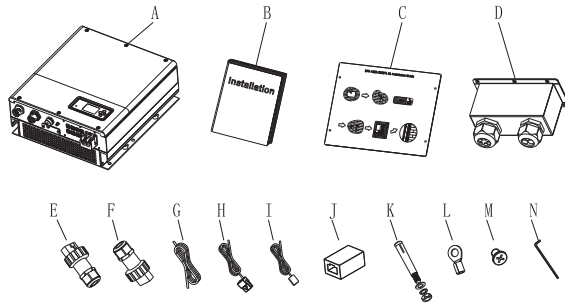

Fig 4.1

Item	Number	Description
A	1	SPA Series(we describe this series as "SPA" as below)
B	1	User Manual
C	1	Paper board(installation guide)
D	1	Waterproof cover
E	1	Online Grid Connector
F	1	Offline Grid Connector
G	2	Communication cable
H	2	Current Sensor from grid to load and from grid to inverter
I	1	Lead-acid battery temperature sensor
J	2	RJ 45 connector
K	4	M6 setscrew
L	2	Battery power terminal
M	6	Screw
N	1	Hex screwdriver

Table 4.1

Installation 5

5.1 Basic installation requirements

- The installation location must be suitable for SPA series's weight for a long period time.
- The installation location must match the size of the SPA series.
- Do not install the inverter on a building constructed of flammable or non-heat resistant materials.
- SPA series's degree of protection is IP65 and can be installed indoors or outdoors. Please refer to the below:



Fig 5.1

- Battery installation option is not far away from the position of SPA series, the length between SPA series and battery should not be more than 1.5m.
- In order to prevent the SPA from reducing the output power due to overheating, please do not expose the SPA to direct sunlight.
- The ambient temperature should be $-25^{\circ}\text{C} \sim 60^{\circ}\text{C}$.
- The humidity of the installation environment should be between 0~95%.
- SPA series can be mounted on a plane that is tilted vertically or backwards. Please refer to the below:

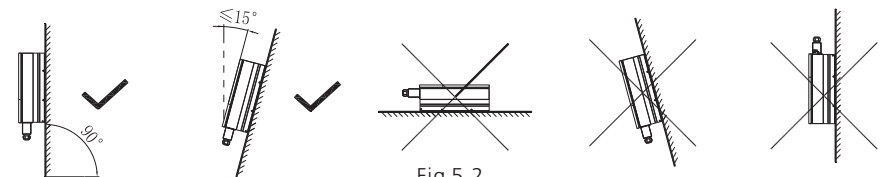

Fig 5.2

- In order to ensure machine can run normally and easy to operate, please pay attention to provide adequate space for SPA series, Please refer to below:

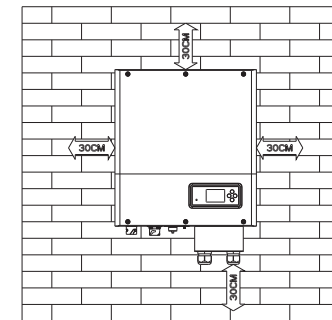

Fig 5.3

- Do not install the machine near television antenna or any other antennas and antenna cables.
- Don't install the machine in the living area.
- Be sure that the machine is out of the children's reach.
- Taking the battery fixing space into account, about the dimensions please reference user manual.
- The Inflammable and explosive dangerous goods must not be placed around battery in case of cause serious danger.

5.2 Tools and instruments



Fig 5.4

No.	Description
1	Press battery terminal connector
2	Unscrew nut
3	Unscrew screw
4	Knock explosion bolt
5	Drill holes on the wall

Table 5.1

LAN line RJ45 sequence as follow:

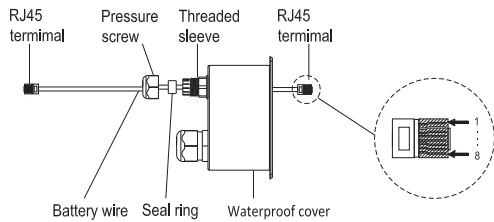

Fig 5.5



Fig 5.6

LAN line 1-8 colors as below:

PIN	1	2	3	4
Color	White orange	Orange	White green	Blue
PIN	5	6	7	8
Color	White blue	Green	White brown	Brown

Table 5.2

5.3 Installation Instructions

5.3.1 Attention Layout

There're three types of sensors for the use of SPA Series. One is wired current sensor, the other one is meter sensor or SP-CT, if you choose wired sensor or meter. Before installing you should know something that as below: The cable of wired sensor and meter is suggested not longer than 15 meters. So you need to consider the length between SPA Series with combiner box for the sensor should be installed in the live line. And if you installed SP-CT for sensor, Distance recommended not more than 30 meters. The installation layout of energy storage machine at home as following:

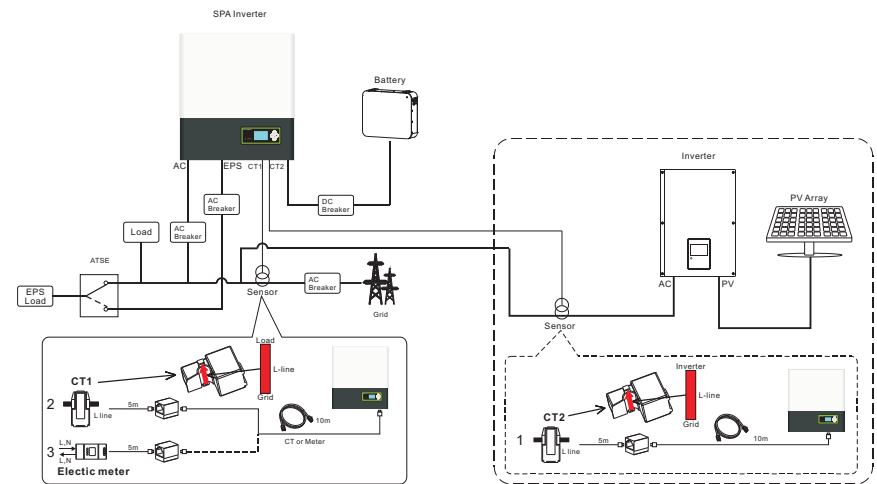

Fig 5.7



NOTICE:

- For battery with DC breaker no need external DC battery.
- The current sensor direction can't be reversed, please follow the arrow direction. Refer to 5.4.3&5.4.6.
- There are 3 types of sensors, the default one is CT with cable, wireless CT and meter are optional.
- Pay attention of the communication max allowed distance of different sensor.

5.3.2 Installation of SPA Series

- Project the machine's probably size on the wall; the thickness of wall for SPA Series must be not less than 60mm.
- Make sure the drill position, use paper board(installation guide), put the paper board cling to the wall, make sure the top edge of paper board is level (As the chart 5.8a below).
- Mark four points at the wall via the hole of the paper board, then remove the paper board.
- Drill four $\Phi 8$ holes at the mark point, the depth is not less than 55mm.
- Knock four explosion bolt into $\Phi 8$ holes (As the chart 5.8b below).
- Hang the energy storage machine on the four setscrews (As the chart 5.8c below).
- Lock the nut of setscrew (As the chart 5.8d below).
- The whole installation has finished.

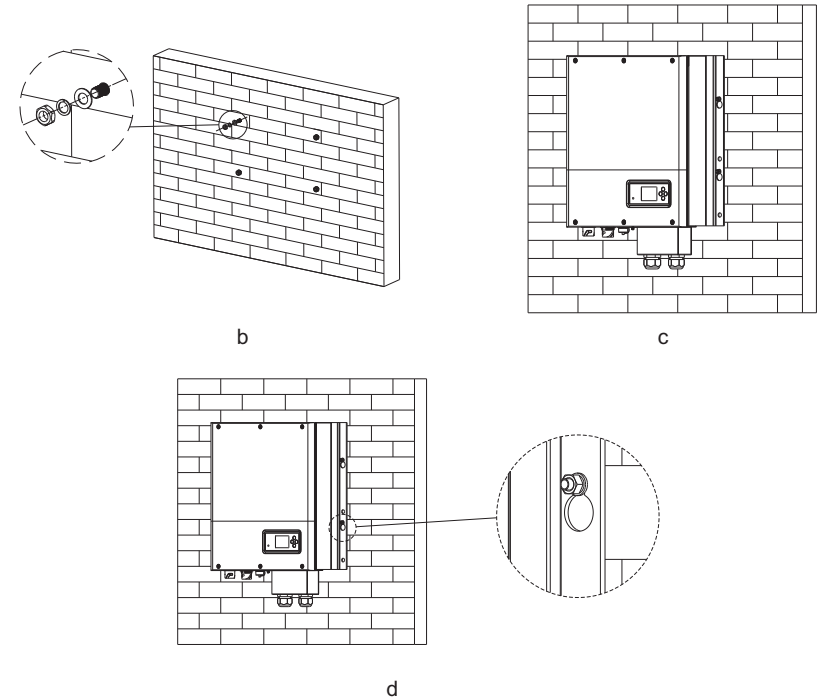
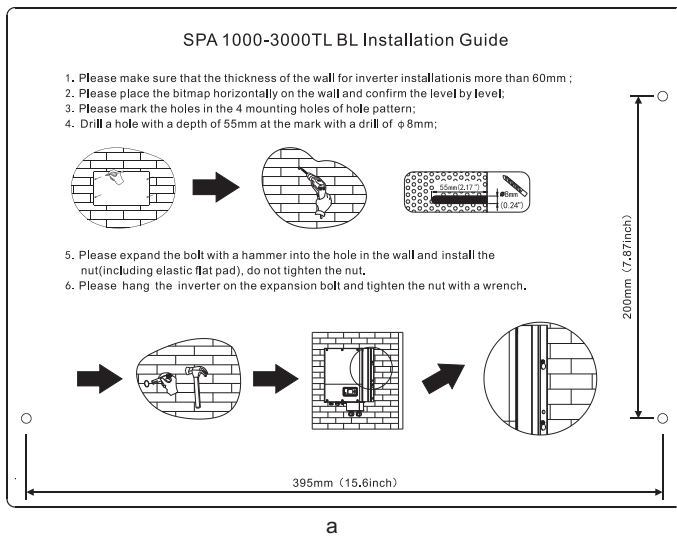

Fig 5.8



a

5.4 System Connection Mode

5.4.1 Connection of Grid and EPS terminal

SPA has a Grid output terminal and EPS out terminal. Look down on the SPA from the front, the terminal on the left (AC grid) is grid outlet for connecting grid, the terminal on the right is an emergency power outlet for connecting critical load.

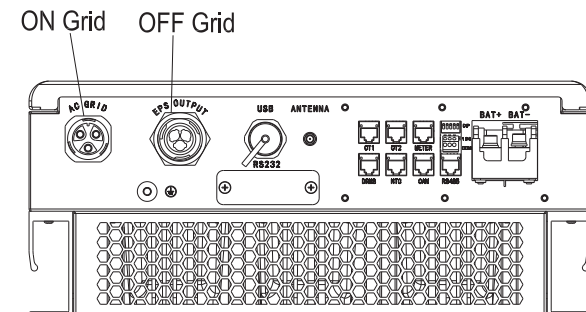

Fig 5.9

The suggest length of the wire

Conductor cross section	Max cable length		
	SPA 1000TL BL	SPA 2000TL BL	SPA 3000TL BL
5.2mm ² 10AWG	60m	50m	30m
3.3mm ² 12AWG	40m	30m	20m

Table 5.3

AC output terminal connection steps as follow:

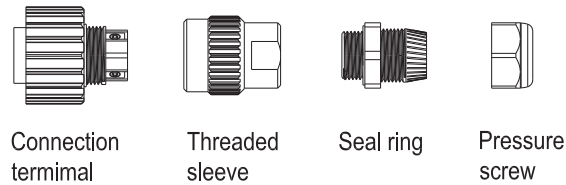

Fig 5.10

Step 1: Uninstall the AC terminal as above chart

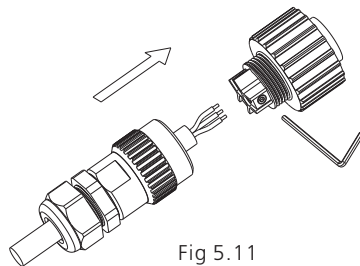

Fig 5.11

Step 2: Thread cables through pressure screw, seal ring, threaded sleeve in sequence, insert cables into connection terminal according to polarities indicates on it and tighten the screws.

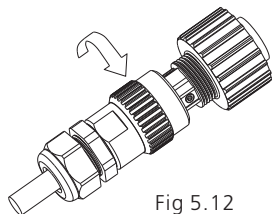

Fig 5.12

Step 3: Push threaded sleeve on to connection terminal until both are locked tightly.

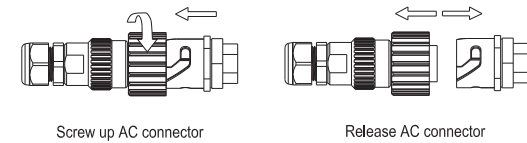

Fig 5.13

Step 4: Plug the socket into AC output terminal, clockwise rotation to tighten the socket, counterclockwise rotation to loosen the socket. The recommended wiring diagram is as follows:

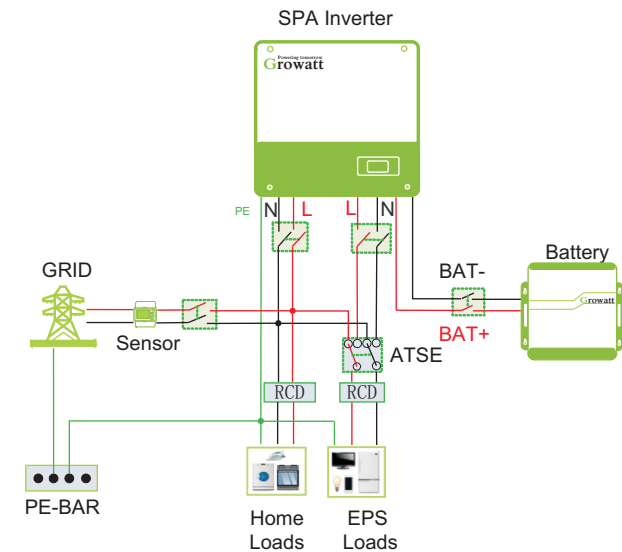

Fig 5.14

•This diagram is an example for grid system without special requirement on electrical wiring connection.

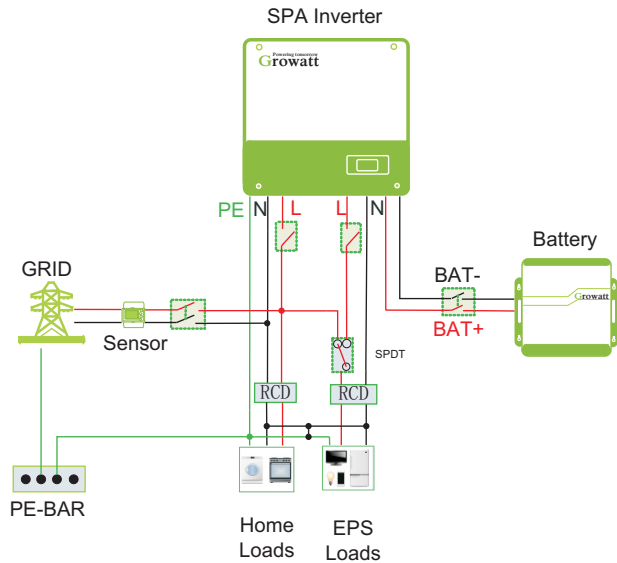

Fig 5.15

•This diagram is an example for Australian and New Zealand grid system where neutral line can't be switched.

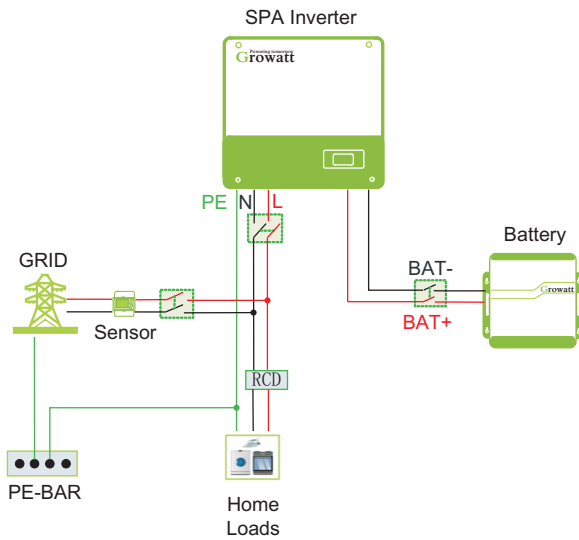

Fig 5.16

This diagram is an example for customer who only want to use the on grid storage system .

Declaration for EPS load

Please make sure the EPS load power is within the SPA output rating, otherwise SPA will shutdown with an EPS Volt Low warning. Three times EPS Volt Low will cause overload warning .EPS function will be locked one hour and output power again.

- Accepted EPS loads, Television, computer, fridge, fan, lamps, microwave oven, electric rice cooker, small power air conditioner and routers etc.
- Unaccepted EPS loads, with high power than SPA output rating and high inrush current at start-up.



NOTICE:

- If you want to use on grid only, please refer to Fig 5.16 to connect with AC grid and float EPS output.
- If you want to use both on grid power and back up power ,please refer to Fig 5.14 and 5.15. connect with AC grid and EPS OUTPUT like the chart show.
- AC grid terminal and EPS terminal can't directly connect together.
- EPS terminal can't connect to grid.
- If you want to use on grid and off grid, you can use ATS (Automatic transfer switch) or EPS Changeover Switch(Manual switch) like Fig 5.14 and 5.15 before or ask Growatt for help to connect them.
- The first start of system needs the Grid power.

5.4.2 Connection of battery terminal

Install battery steps are as follows:

- Open the waterproof cover.
- Thread cables through pressure screw, seal ring, threaded sleeve, waterproof cover.
- Thread cables into connection terminal, then press the terminal by relevant tools and make sure battery cables are firmly (Growatt lithium battery contains a battery cable in the original packing) .
- Connect positive pole (+) of battery cable to battery positive terminal (+) of the inverter, connect negative pole (-) of battery cable to battery negative terminal (-).

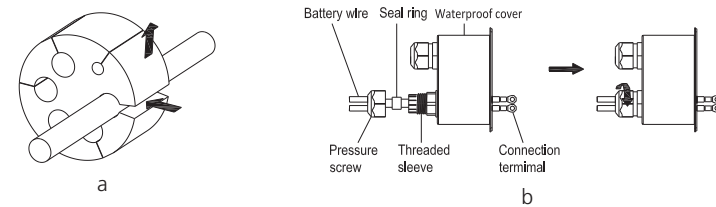

Fig 5.17

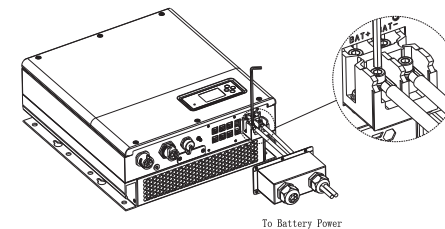

Fig 5.18



NOTICE:

We suggest the distance between battery and SPA Series no longer than 1.5m, and The power line area must be larger than 6 AWG(13.3mm²).

5.4.3 Connection of CT2 terminal

If the SPA is installed with an existing inverter, there is a CT2 to monitor the inverter current.

The CT2 terminal connection steps are as follows:

- Unscrew the swivel nut from the cable gland.
- Thread the swivel nut over the "CT2" cable.
- Press the cable support sleeve out of the cable gland.
- Remove the filler plug from the cable support sleeve.
- Route the "CT2" cable through an opening in the cable support sleeve.
- Thread the "CT2" cable through the cable gland.
- Insert the RJ45 plug of the network cable into the "CT2" pin connector on the inverter until it snaps into place.
- If no other cables need to be installed, lock the waterproof cover to the inverter with screws.
- Screw the swivel nut onto the waterproof cover.

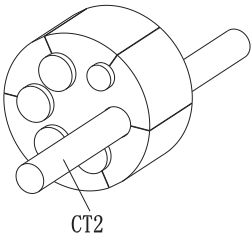

Fig 5.19

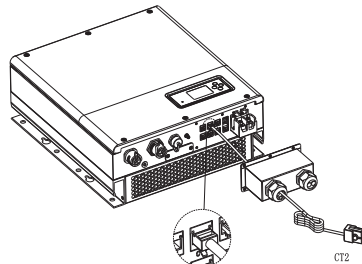

Fig 5.20



NOTICE:

- If the cable such as "CT2" cable is not used, please do not remove the filler plug from the cable support sleeve.
- Ct2 wire (5m in length) specification: RJ45, standard LAN line (one end with 8P modular plug, the other connected with current transformer). But if the length is not enough, customer can add cable, so the length can be increased to 15m max, the operation is as follow Fig:

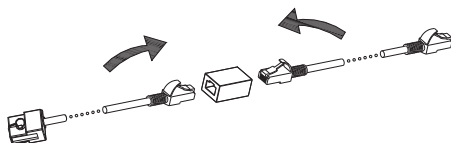

Fig 5.21

During the actual operation, please pay attention to the installation of current transformer as the diagram shows below:

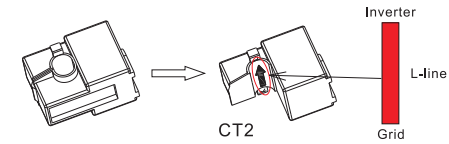

Fig 5.22

As illustrated above, open the current transformer and you can see an arrow labeled on it indicating the direction of current. Put the live wire among the under-detection wires onto the current transformer. After latching the current transformer, the installation has been finished.



NOTICE:

The direction of the arrow on the current transformer is corresponding to the direction of the current in live wire from grid to the existing inverter. Current transformer needs to be placed in the power distribution cabinet.

5.4.4 Connection of CT1 terminal

There is a CT1 in SPA series monitoring the power consumption situation of residential users, the CT1

terminal connection steps are as follows:

- Unscrew the swivel nut from the cable gland.
- Thread the swivel nut over the "CT1" cable.
- Press the cable support sleeve out of the cable gland.
- Remove the filler plug from the cable support sleeve.
- Route the "CT1" cable through an opening in the cable support sleeve.
- Thread the "CT1" cable through the cable gland.
- Insert the RJ45 plug of the network cable into the "CT1" pin connector on the inverter until it snaps into place.
- If no other cables need to be installed, lock the waterproof cover to the inverter with screws.
- Screw the swivel nut onto the waterproof cover.

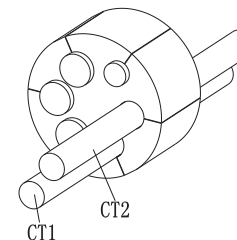

Fig 5.23

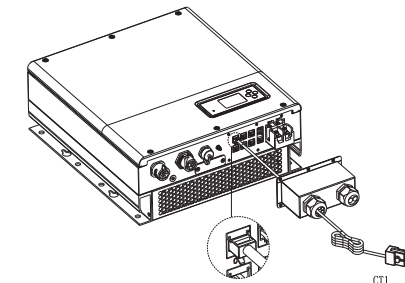

Fig 5.24



NOTICE:

- The meter and CT1 can't be installed at same time, please set the sensor model when selecting CT1 or electricity meter, please refer to section 6.4.4 for details.
- If the cable such as "CT1" cable is not used, please do not remove the filler plug from the cable support sleeve.
- CT 1 wire (5m in length) specification: RJ45, standard LAN line (one end with 8P modular plug, the other connected with current transformer). But if the length is not enough, customer can add cable, so the length can be increased to 15m max, the operation is as follow Fig:

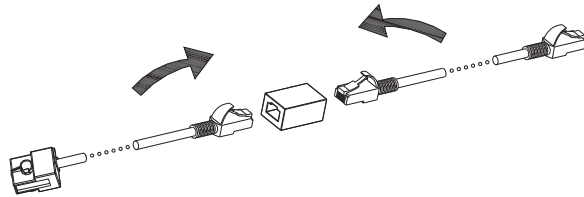

Fig 5.25

During the actual operation, please pay attention to the installation of current transformer as the diagram shows below:

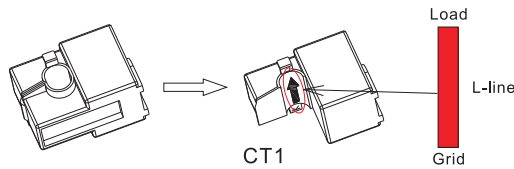

Fig 5.26

As illustrated above, open the current transformer and you can see an arrow labeled on it indicating the direction of current. Put the live wire among the under-detection wires onto the current transformer. After latching the current transformer, the installation has been finished.



NOTICE:

The direction of the arrow on the current transformer is corresponding to the direction of the current in live wire from grid to the load. Current transformer needs to be placed in the power distribution cabinet.

5.4.5 Connection of meter terminal

We also can use meter instead of CT1 in SPA series to monitor the power consumption situation of

residential users, the meter terminal connection steps are as follows:

- Reference 5.2, make LAN cables with RJ45 terminal.
- Thread the swivel nut over the LAN cable.
- Press the cable support sleeve out of the cable gland.
- Remove the filler plug from the cable support sleeve.
- Route the LAN cable through an opening in the cable support sleeve.
- Thread the LAN cable through the cable gland.
- Insert the RJ45 plug of the network cable into the "Meter" pin connector on the inverter until it snaps into place.
- If no other cables need to be installed, lock the waterproof cover to the inverter with screws.
- Screw the swivel nut onto the waterproof cover.

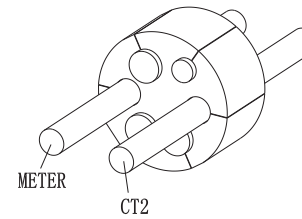

Fig 5.27

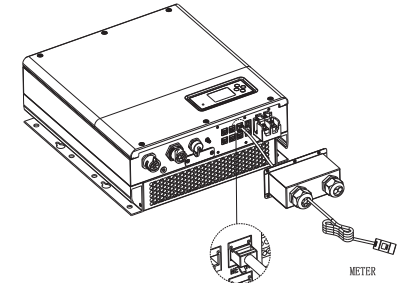

Fig 5.28



NOTICE:

- Meter and CT can't be installed at same time, please set the sensor model when selecting CT or electricity meter, please refer to section 6.4.4 for details.
- Meter must be provided by Growatt. If not, maybe meter can't communicate with SPA series.
- The more detail describe of meter installation, please turn to meter user manual
- Please do not disconnect the RJ45 terminal of CT when CT is detecting current.

5.4.6 Connection of communication terminal for lithium battery(RS485)

When using lithium batteries which need to connect BMS system of the battery, connect lithium battery terminal (RJ45) steps as follows:

- Unscrew the swivel nut from the cable gland.
- Thread the swivel nut over the "RS485" cable.
- Press the cable support sleeve out of the cable gland.
- Remove the filler plug from the cable support sleeve.
- Route the "RS485" cable through an opening in the cable support sleeve.
- Thread the "RS485" cable through the cable gland.
- Insert the RJ45 plug of the network cable into the "RS485" pin connector on the inverter until it snaps into place.
- If no other cables need to be installed, lock the waterproof cover to the SPA with screws.
- Screw the swivel nut onto the waterproof cover.

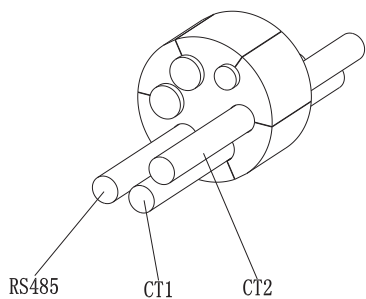

Fig 5.29

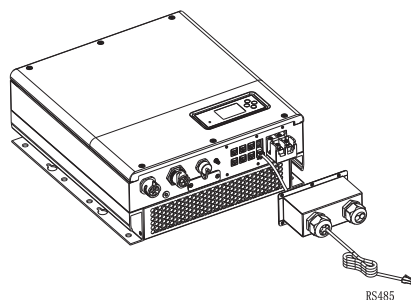

Fig 5.30

5.4.7 Connection of communication terminal for lithium battery(CAN)

When using CAN communication with lithium batteries, connect lithium battery terminal (RJ45) steps as follows:

- Unscrew the swivel nut from the cable gland.
- Thread the swivel nut over the "CAN" cable.
- Press the cable support sleeve out of the cable gland.
- Remove the filler plug from the cable support sleeve.
- Route the "CAN" cable through an opening in the cable support sleeve.
- Thread the "CAN" cable through the cable gland.
- Insert the RJ45 plug of the network cable into the "CAN" pin connector on the inverter until it snaps into place.
- If no other cables need to be installed, lock the waterproof cover to the inverter with screws.
- Screw the swivel nut onto the waterproof cover.

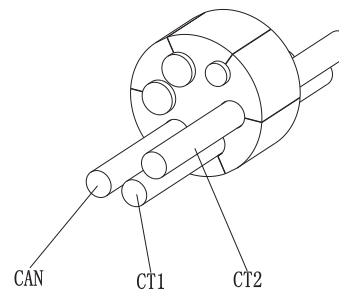

Fig 5.31

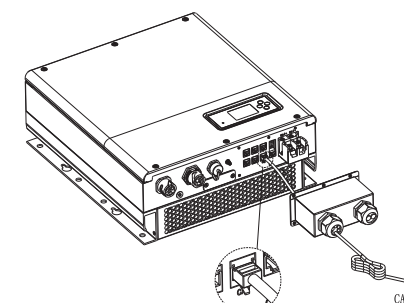

Fig 5.32



NOTICE:

- If you are using a lead-acid battery, you do not need to install this communication cable, please skip this step to 5.4.5.
- The CAN battery communication and RS485 battery communication can't be installed at same time, please select the correct communication method according to the battery manual.
- If the cable such as "RS485" cable or "CAN" cable is not used, please do not remove the filler plug from the cable support sleeve.



NOTICE:

- If you are using a lead-acid battery, you do not need to install this communication cable.
- The CAN battery communication and RS485 battery communication can't be installed at same time, please select the correct communication method according to the battery manual.
- If the cable such as "RS485" cable or "CAN" cable is not used, please do not remove the filler plug from the cable support sleeve.

5.4.8 Connection of temperature probe for lead-acid battery

When customer using lead-acid battery, the temperature probe of the lead-acid battery is used to detect the ambient temperature of the lead-acid battery, the battery temperature cable of the SPA side connection steps are as follows:

- Unscrew the swivel nut from the cable gland.
- Thread the swivel nut over the "NTC" cable.
- Press the cable support sleeve out of the cable gland.
- Remove the filler plug from the cable support sleeve.
- Route the "NTC" cable through a min opening in the cable support sleeve.
- Thread the "NTC" cable through the cable gland.
- Insert the RJ45 plug of the network cable into the "NTC" pin connector on the inverter until it snaps into place.
- If no other cables need to be installed, lock the waterproof cover to the SPA with screws.
- Screw the swivel nut onto the waterproof cover.



NOTICE:

- If you are using a lithium battery, you do not need to install this temperature probe, the probe of the temperature cable should be attached to the surrounding environment of the lead-acid battery, and the length of this cable is 1.5m, so pay attention to the distance of battery and SPA series.
- If the cable such as "NTC" (lead-acid battery temperature sensor) cable is not used, please do not remove the filler plug from the cable support sleeve.

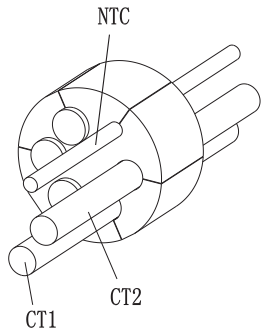

Fig 5.33

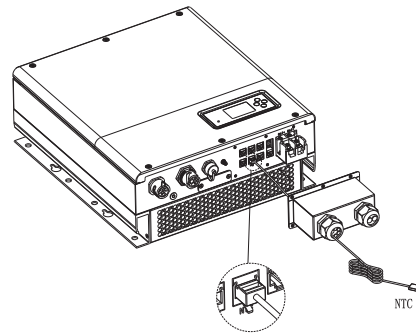

Fig 5.34

5.4.9 Connection of DRMs terminal(Australia only)

When SPA series is applied to Australia, the DRMS terminals need to be connected, the connection way appears as follows:

- Unscrew the swivel nut from the cable gland.
- Thread the swivel nut over the "DRMS" cable.
- Press the cable support sleeve out of the cable gland.
- Remove the filler plug from the cable support sleeve.
- Route the "DRMS" cable through an opening in the cable support sleeve.
- Thread the "DRMS" cable through the cable gland.
- Insert the RJ45 plug of the network cable into the "DRMS" pin connector on the inverter until it snaps into place.
- If no other cables need to be installed, lock the waterproof cover to the inverter with screws.
- Screw the swivel nut onto the waterproof cover.

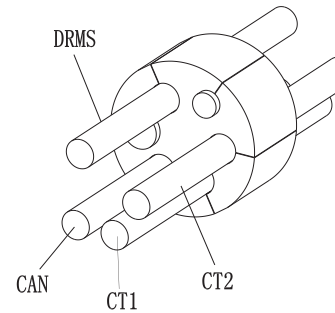

Fig 5.35

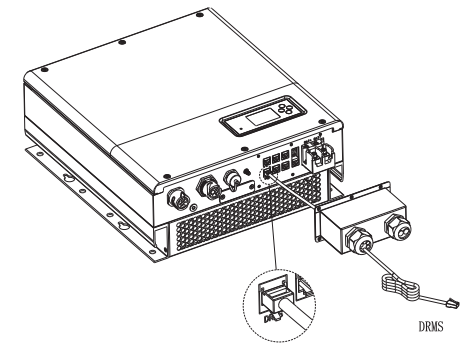

Fig 5.36

RJ 45 terminal pin assignment:

PIN	Assignment for inverter scapable of both charging and discharging	PIN	Assignment for inverter scapable of both charging and discharging
1	DRM1/5	2	DRM2/6
3	DRM3/7	4	DRM4/8
5	RefGen	6	COM/DRM0
7	/	8	/

Table 5.4

Method of asserting demand response modes:

MODE	RJ 45 socket asserted by shorting pins		Requirement
DRM0	5	6	Operate the disconnection device.
DRM1	1	5	Do not consume power.
DRM2	2	5	Do not consume at more than 50% of rated power.
DRM3	3	5	Do not consume at more than 75% of rated power and source reactive power if capable.
DRM4	4	5	Increase power consumption(subject to constraints from other active DRMs).
DRM5	1	5	Do not generate power.
DRM6	2	5	Do not generate at more than 50% of rated power.
DRM7	3	5	Do not generate at more than 75% of rated power and sink reactive power if capable.
DRM8	4	5	Increase power generation (subject to constraints from other active DRMs).

Table 5.5



NOTICE:

If the cable such as "DRMs" cable is not used, please do not remove the filler plug from the cable support sleeve.

5.4.10 Grounding connection

SPA series must be grounded by cable, the grounding point is showed as follow, and the minimum grounding cable wire diameter is 10AWG(5.26mm²).

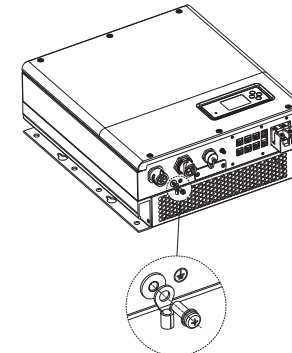

Fig 5.37

6 Commissioning

6.1 Commissioning of SPA

1) Electrify SPA series after all installation of Part 5 be finished, here are the steps:
Turn on AC first

- Then turn on battery
 - If Grid and battery are available, the SPA would work on the "normal" mode. When the SPA work under the normal mode, the screen showing "normal" and the LED is green.
- 2) If SPA do not enter normal mode successfully, especially the LCD is red, you need to check below:
- Make sure all the connection is correct.
 - All the external switches are on.
 - Make sure the lithium battery is on.
 - Refer to Part 9.1 for correction.

You can refer to 6.4.4 for work mode setting, then configure monitor, finish commissioning lastly.

6.2 Operation modes

6.2.1 Normal mode

Normal mode is working state which including online mode and backup mode.

Online mode

User can set an appropriate priority mode according to request when SPA working on the online mode. If customer use the LCD and key settings, you can only set one period, but if you use website settings, you can set up to three periods of the priority mode. Please refer to 6.4.4 for details.

Load first: Load first is the default mode.

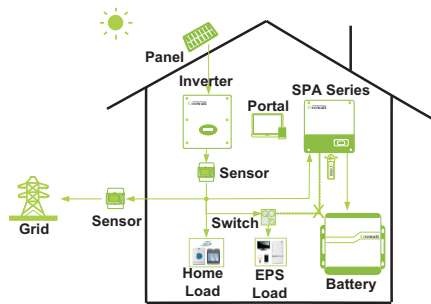

Fig 6.1

- With inverter, energy from inverter optimize load, then charge battery, exceed power export to the grid.

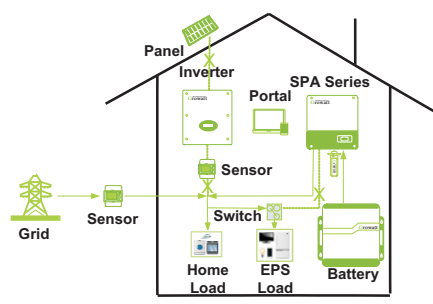

Fig 6.2

- Without inverter or the energy from inverter is weak, the battery will discharge for load firstly and the grid will supply the power when the battery power is not enough.

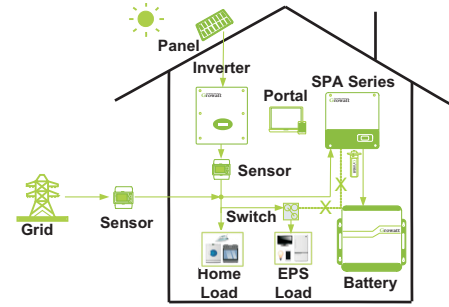

Fig 6.3

- With inverter, energy from inverter charge battery, then load and the grid will supply the power when the inverter power is not enough.

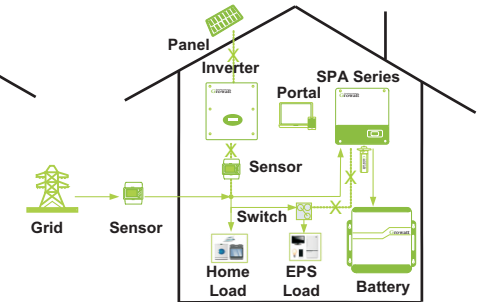

Fig 6.4

- Without inverter or the energy from inverter is weak, the grid will charge the battery and load.

Grid first: When SPA series working under Grid-first mode, the battery energy would feed to Grid first. User can choose the period when electric charge is high. User need to set the mode ON and OFF time, and the end time of battery SOC. User can set power rate which less than the battery maximum output power.

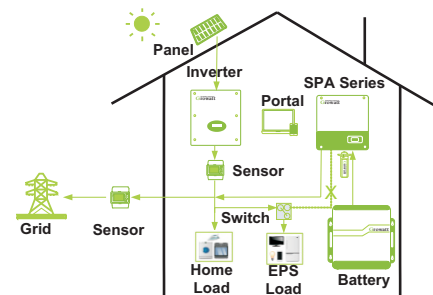

Fig 6.5

- With inverter, battery discharge to load. If the sum of inverter power and battery power is greater than the load, excess power flows to the grid.

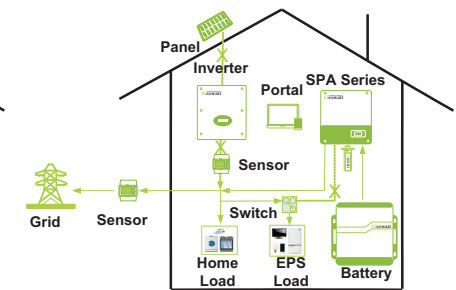

Fig 6.6

- Without inverter or the energy from inverter is weak, battery discharge to load and excess power flows to the grid.

Backup mode: If the grid lost ,system would turn to backup mode(user can disable it ,refer to 6.4.4) and AC output is from EPS port. All of the energy is from battery .SPA maximum output power is SPA nominal power in this mode, the load which connect with EPS port should be less than SPA nominal power.

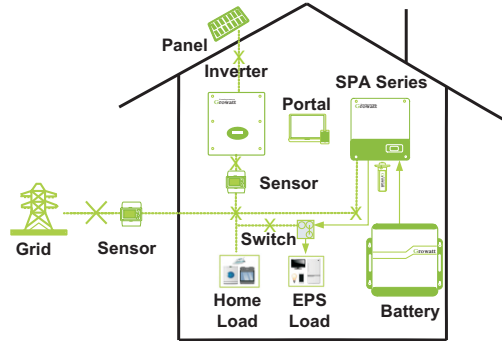

Fig 6.7

- Without grid, battery discharge to EPS load. SPA work under EPS mode.



NOTICE:

For Battery first and Grid first mode, customer can set the timetable for it. Through LCD can set one time period, through Growatt ShineServer can set 3 time periods each.

6.2.2 Fault mode

The SPA's intelligent control system could monitor and adjustment system's status continuously, when SPA series monitoring anything unexpected happen, such as system fault or machine fault ,the LCD will display the fault information, in fault mode, the red LED light will be lighten.



NOTICE:

- The detail's fault information please refer to 9.1.
- Some fault information is in order to remind users that have some faults occurred in SPA side.

6.2.3 Programming mode

Programming mode indicate the SPA is updating ,don't cut out power(Grid and Battery) when it's updating until the processing is finish.SPA inverter would log out automatically when the updating is finished and turn to other mode .

6.2.4 Checking mode

Before SPA work in normal mode, it will go to self-check mode. If all are ok, system will go to normal mode ,otherwise, it will go to fault mode.

6.2.5 Standby mode

If the system has a fault ,SPA will report an error and then enter standby mode.

6.2.6 Shutdown mode

If user need SPA stop working, user must disconnect all the energy source, then SPA will turn into shutdown mode automatically. The following is the shutdown procedure:

- Turn off battery switch.
- Shut down AC power. Then you can see the both LED and LCD are off.



NOTICE:

After all the actions are done, you still have to wait for more than 5 minutes.

6.3 Country setting

Growatt can provide various regulations of the machine, after customers receive the machine, according to their country, by dialing DIP switch to set the corresponding regulations. Following is the DIP switch introduction.

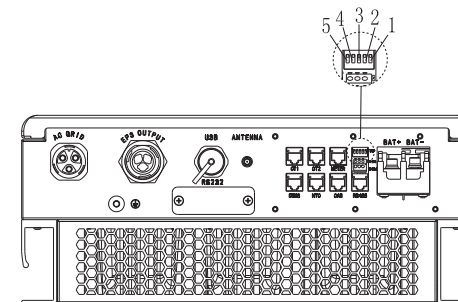

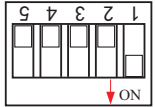
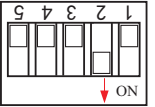
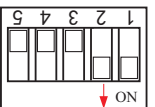

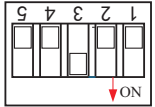
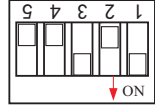
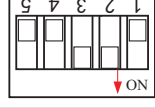
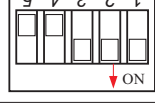
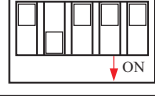



Fig 6.8

	<p>Caution : When you setting the DIP, you must turn off AC and battery breaker to make sure all of the power are off.</p>
	<p>Caution: 1. After setting the DIP, please power on the SPA series and check the model display (show as 6.3.1). If the model display is match what you want, it means your setting is successful. 2. You need to calibrate the time that the machine is showing after SPA series starts up. If the country is set incorrectly, please shut down the SPA series and set again</p>

The DIP switch is composed of five-digit binary number PINS. The different combination of the five PINS can represent different model, which is corresponding to the local grid standard. Each small white PIN has two statuses, when set upward to "ON", its value turns to "1", when set downward, its value turns to "0". Concerning the matching of the PIN status and the country safety standard, please refer to the table below:

6.3.1 Switch to country table

DIP switch status	Country/region / regulations	Model display
	VDE 0126	GT0XXXXXX1
	Queensland	GT0XXXXXX2
	As4777	GT0XXXXXX3

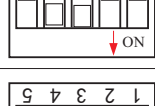
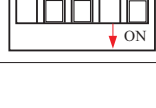
	CEI 0-21	GT0XXXXXX4
	G99	GT0XXXXXX5
	XINA1	GT0XXXXXX6
	VDE-AR-N 4105	GT0XXXXXX7
	G98	GT0XXXXXX8
	Norway-EN50438	GT0XXXXXX9
	CQC	GT0XXXXXXA
	Danmark-EN50438-1	GT0XXXXXXB
	Hungary	GT0XXXXXXC
	Belgium	GT0XXXXXXD

	Thailand MEA	GT0XXXXXXE
	Thailand PEA	GT0XXXXXXF
	Sp1663	GT1XXXXXX0
	CQC-1	GT1XXXXXX1
	TAIWAN	GT1XXXXXX2
	EN50438-Ireland	GT1XXXXXX3
	TUV000	GT1XXXXXX4

Table 6.1

6.4 Display and button

6.4.1 LCD display area

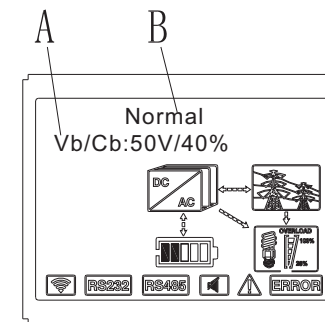

Fig 6.9

Location	Description
A	Information
B	State
C	SPA inverter
D	Power flow line
E	Grid
F	Local load
G	Wireless communication
H	RS 232
I	RS 485
J	Battery (show the SOC in five grid, Every grid represents 20%)
K	Buzzer(Reserved)
L	Warning
M	Fault

Table 6.2

6.4.2 LED and button instruction

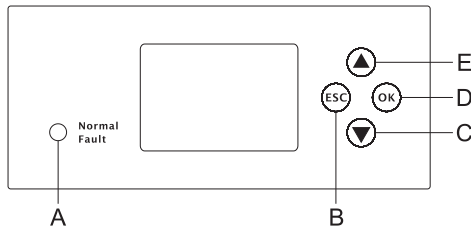

Fig 6.10

Location	Description
A	Status
B	ESC- button(cancel control)
C	Down-button
D	Enter-button
E	UP-button

Table 6.3

Description	Explanation	
Push-button	Operation of display screen and set system	
Status symbol of SPA	Green light on	SPA run normally
	Red light on	Fault state
	Green light blinking	Alarm state
	Red light Software updating	Software updating

Table 6.4

6.4.3 LCD display column

LCD display column is used to show the current state, basic information and fault information. Also include language setting, program charging/discharging priority and system time. On default condition will take turns to display the information.

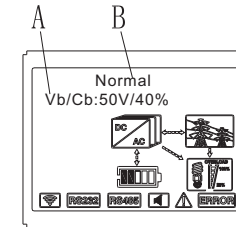

Fig 6.11

The A line's concluding information as follow:

- Standby state:** SPA series is in standby state. No error in this state, but for other reasons, make it in a wait state.
- Normal state:** SPA series is in normal working state.
- Checking state:** SPA series is in self-check state, if there is no error or warning, SPA will go to normal state or standby state. Otherwise it will go to fault state.
- Programming state:** SPA is in updating firmware state.
- Fault state:** SPA has fault information, it will be in stopped operational protection state.

The B line's information as follow:In normal, it will turn on page automatically, when pushing the button

“UP”, the order of the paging information as follow:

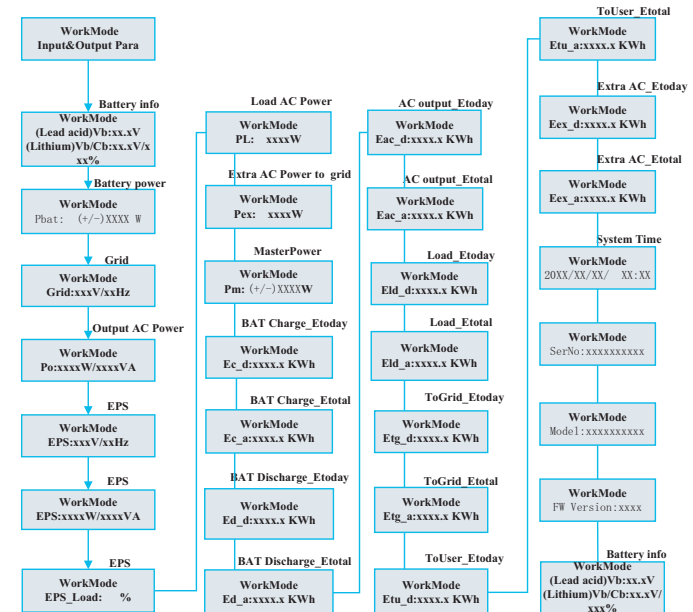

Fig 6.12

Some special definitions:

Parameter:Description

Vb:Battery voltage

Cb:Battery capacity (only for lithium battery)

Pm:Power monitoring (from grid is positive, to grid is negative)



NOTICE:

- “Down” control command (if pushing “up” button, command will go back).
- Workmode depend on the situation. If SPA is in normal state, it will show “normal”. If SPA is standby state, it will show as “standby” etc.
- Some special definitions are explained, for example: Vb means the voltage of battery. Cb means the capacity of lithium battery (only lithium battery show this data). Pm means the monitor power of user.

6.4.4 Work mode set up

Keep pressing “enter” for 3S, you can enter set up surface, in the set up surface you need hold button.

Enter or ESC 1S for selection, you can see the surface as showing below.

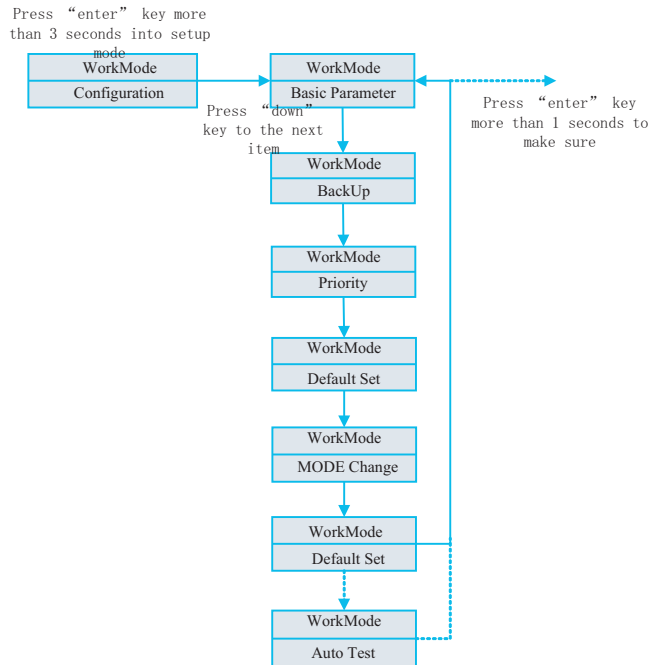

Fig 6.13

If you choose CEI and used SPA inverter in Italy, SPA inverter have Auto Test function. How to use the Auto test function. Please see the annex.

- Under the Basic Para ,you can see the setup options below after pressing Enter for 1S:

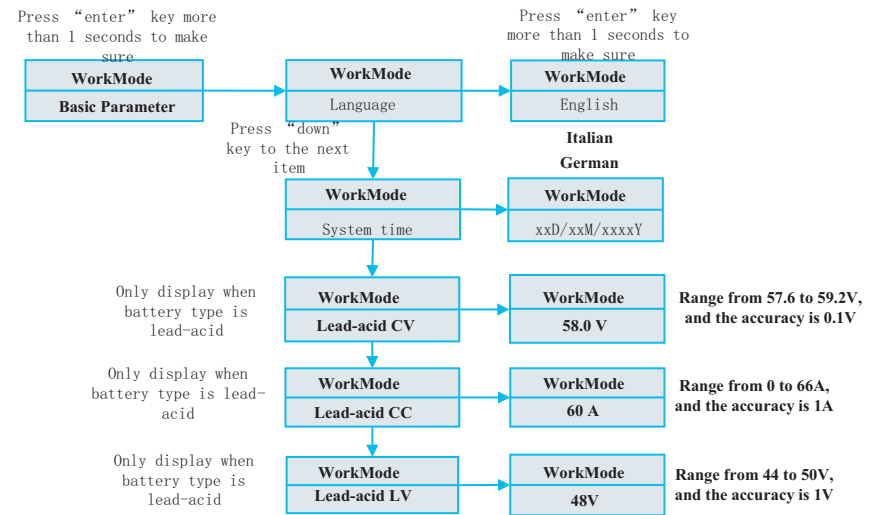

Fig 6.14

In the basic Parameter, you can set language (English, Italian ,German) , system time , lead-acid cell charging voltage (default is 58V), discharge low voltage (default is 48V)and lead-acid constant current (default is 60A).

Under the Back Up ,you can see the setup options below after pressing Enter for 1S:

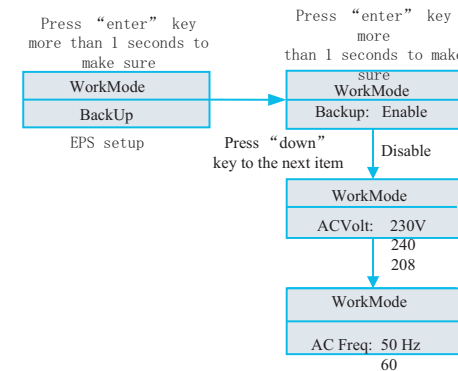

Fig 6.15

In the back up you can set EPS ,including enable or disable (default is enable),AC voltage(default is 230V) and frequency(default site 50HZ).If the Backup mode IS disabled,the inverter will turn off the EPS output when there is no grid.

Under the Priority ,you can see the setup options below after pressing Enter:

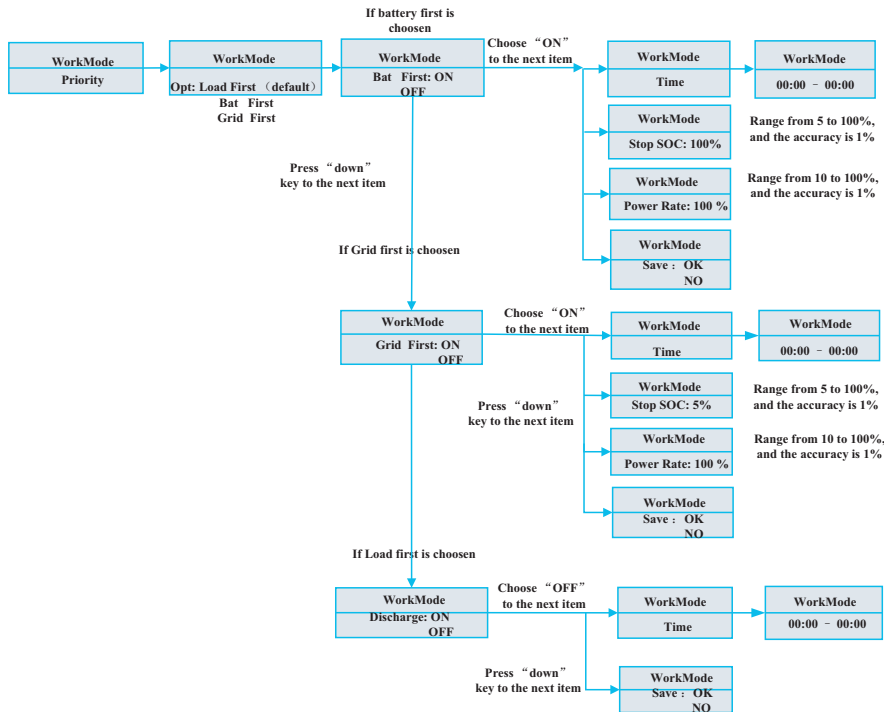

Fig 6.16



NOTICE:

- "Power Rate" is used to set up power of battery. So different battery may has the different power, customer need to check the max power of battery.
- Time setting is 24-hour. If the end time is less than beginning time, it defaults to spanning days.

Under the MODE Change ,you can see the setup options below after pressing Enter:

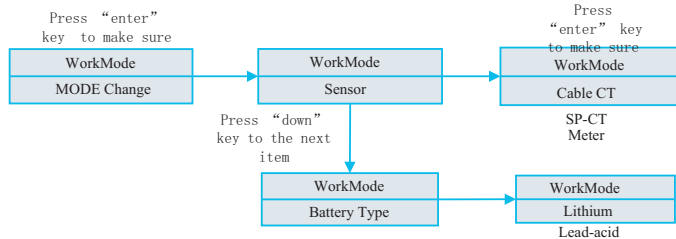

Fig 6.17

The MODE change has two options which are sensor and battery types. In the sensor types, you can choose cable CT (default) , meter and SP-CT (wireless RF transfer) .In the battery types, you can chose lithium battery or lead-acid battery. Under the default set ,you can see the setup options below after pressing Enter:

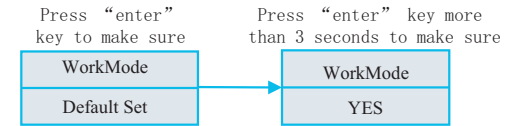

Fig 6.18

Default set is "resume to default setting ",please don't use it unless it's necessary.

6.5 Communication

6.5.1 U-disk Firmware upgrade

User can upgrade inverter's firmware via the USB port use a U-disk.

Please contact Growatt service support to get the upgrade files, and extract into the U-disk.

- Warning: Don't modify the folder name or program file name, it may cause the upgrade failed.
- Unscrew the waterproof lid and insert U-disk into the USB port, the upgrade will begin automatically.
- The LCD will show "Programming" during upgrade, after finished, it will show "Program OK", and inverter will back to normal working state. Then pull out the U-disk, and screw the waterproof lid.

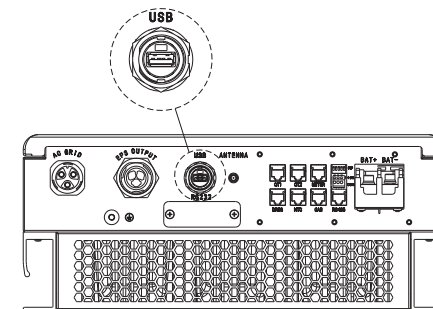

Fig 6.19



NOTICE:

USB is only used for firmware update. Customer can't use it for charging.

6.5.2 Use of RS232 port

For local control, user can use USB to RS232 cable connect the inverter to computer, and run software ShineBus, to do parameters checking and setting, do firmware upgrade and so on. Please contact Growatt support for ShineBus software. About ShineBus software, when you needed, please download from official website of Growatt.

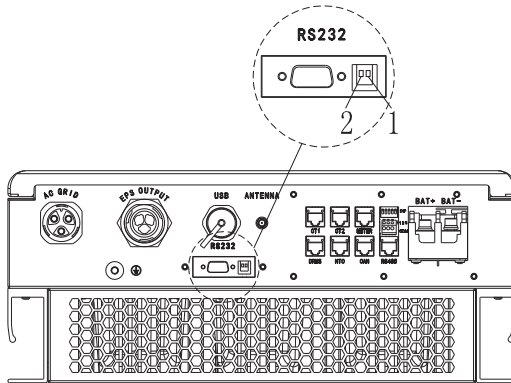

Fig 6.20

The wiring diagram is as follows:

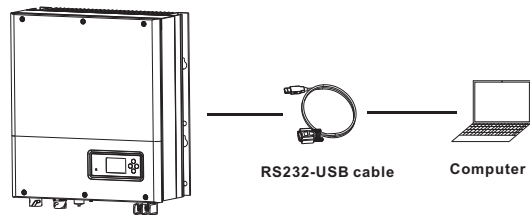

Fig 6.21

6.5.3 The SPA's monitoring

The SPA provide RS232 interface. Users can monitor the SPA through the following communication solution.

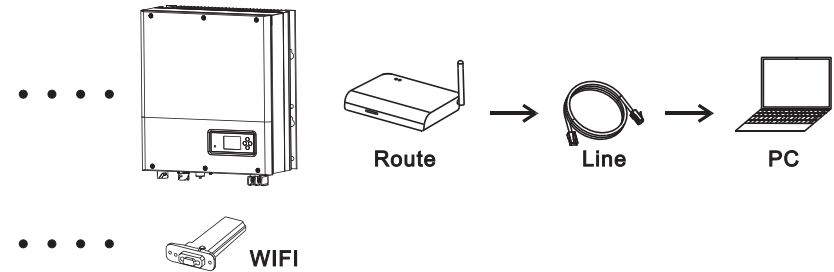

Fig 6.22

WiFi connection (optional)

WiFi connection steps:

- Remove the RS232 port cover, turn the small DIP switch Pin1 and Pin2 to ON.
- Plug WiFi-S module into the RS232 port, and configure the connection between WiFi module and router.
- Create a user account online.
- Please check the ShineWiFi-S manual for details.

RF connection (optional)

RF connection steps:

- Remove the RS232 port cover, turn the small DIP switch Pin1 and Pin2 to ON.
- Plug RF module into the RS232 port, connect the Lanbox to Router.
- Create a user account online.
- Please check the ShineLink manual for details.



NOTICE:

This kind of monitoring can only be used by the monitor of Growatt's Shineserver /shine phone provided by the company. Through RS232 interface connect to Wi-Fi-S/shinelink, use computer terminal/or mobile phone for data monitoring.

7 Start-up and shut down SPA system

7.1 Start-up the SPA system

Users can start-up SPA inverters through following steps:

- Turn the switch on in turn of Grid and battery.
- When the LED turns green, the working information on LCD indicates the successful start-up of SPA series.

7.2 Disconnect the SPA system

- Turn the switch off in turn of Grid and battery.
- Waiting until LED and LCD display have gone out, the SPA is shut down completely.

Attention of the installation 8

Heat dissipation performance is very important when SPA series work under the environment of high temperature. Better heat dissipation can reduce the possibility of SPA series stops working. The SPA series is fanless and belongs to natural cooling. The hot air on the top of the radiator is matched with the battery. The environment is IP65. Please pay attention to the temperature of the installation environment, to ensure that the battery's safety and the normal work of the machine.

When use battery, please pay attention to the follow information:

Caution: Do not dispose of batteries in a fire. The batteries may explode.

Caution: Do not open or damage batteries. Released electrolyte is harmful to the skin and eyes.

It may be toxic.

Caution: A battery can present a risk of electrical shock and high short-circuit current.

The following precautions should be observed when working on batteries:

- Remove watches, rings or other metal objects.
- Use tools with insulated handles.
- Wear rubber gloves and boots.
- Do not lay tools or metal parts on top of batteries.
- Disconnect charging source prior to connecting or disconnecting battery terminals.
- Determine if battery is inadvertently grounded. If inadvertently grounded, remove source from ground. Contact with any part of a grounded battery can result in electrical shock. The likelihood of such shock can be reduced if such grounds are removed during installation and maintenance (applicable to equipment and remote battery supplies not having a grounded supply circuit).

If SPA series doesn't work for overheating or too cold, solve it according to the following methods:

- Confirm whether the radiator air duct installation is reasonable, choose the appropriate position before installation.
- If lead-acid batteries are connected, confirming the NTC of battery is in a good installation.
- Confirm whether the battery temperature is too high, too high temperature of battery can also lead to SPA fail to work, at this point, to ventilation, cooling or handle to the battery.
- If temperature is low, also can appear the battery low temperature protection. The battery will start with small load in low temperature output. After temperature back to normal system can work normally. Please be patient at this time.
- If the temperature is too low, it is possible that battery will be low temperature protection, at this time, please pay attention to the working temperature range listed in the specifications of the book.
- Servicing of batteries should be performed or supervised by personnel knowledgeable about batteries and the required precautions.
- When replacing batteries, replace with the same type and number of batteries or battery packs.
- General instructions regarding removal and installation of batteries.

Remark: All of above action should be operated by professional person, if you want to do these works, you must make sure the whole system are off.

9 Trouble shooting

Our products are rigorously tested before production. If you have difficulty in the installation process, please visit www.ginverter.com to view the Q&A plan.

When SPA inverter fault happens, please inform our company, and to provide SPA series related

information, we will have a professional after-sales service personnel to answer you.

What you need to provide the information about the SPA series including :

- Serial number
- Model
- Information about the LCD display
- Brief description of problems
- The grid voltage and frequency
- Can you retell the failure problem? If you can, what kind of a situation
- Did the problem happen in the past?
- When did this fault happen? First installation?

About the battery:

- The manufacturer name and model of battery.
- Serial number
- Capacity of battery.
- The time you buy battery and frequency you use it.

9.1 System fault information list and trouble shooting suggestions

Warning message		
Error message	Description	Suggestion
Warning401	SP-CT/Meter Communication fault.	1.Make sure the wire between meter and inverter connect well. 2.Make sure the distance of SP-CT and inverter is in the range of specification. Restart inverter and SP-CT,reconnect.
Warning506	Battery temperature out of specified range for charging or discharging.	Make sure the environment temperature of battery is in the range of specification.
AC V Outrange	Grid voltage fault. Please refer to the local grid standard for more details of the grid voltage.	1. Make sure AC voltage is in the range of local standard. 2. Make sure the AC cable is well connected.

AC F Outrange	Grid frequency fault. Please refer to the local grid standard for more details for the grid frequency.	1. Make sure the frequency is in the range of local standard. 2. Restart inverter. Please contact Growatt service center if restart not work
PairingTimeOut	Communication fault	1. Make sure the distance of SP-CT and inverter is in the range of specification. 2. Restart inverter and SP-CT, reconnect.
CT LN Reversed	LN Reversed	1. Make sure the L line and N line of SP-CT is not reversed. 2. Make sure the PE of SP-CT is well connected.
BMS COM Fault	Communication fault	1. Check the lithium Battery is open or not. 2. Check the connection of lithium Battery and SPA series is good or not.
Battery reversed	Battery terminals reversed	Make sure the positive and negative of battery is not reversed.
BAT NTC Open	NTC open (only for lead-acid battery)	Make sure the temperature probe of lead-acid battery is well installed.
Battery Open	Battery terminal open (only for lithium battery)	1. Make sure the battery is well connected. 2. Make sure battery switch is turned on. 3. Make sure the breaker between the battery and inverter is on.
Over Load	EPS output overload warning. Three times EPS Volt Low will cause overload warning .Off-grid function will be locked one hour and output power again.	Please reduce the load of EPS output.

No AC Connection	No Utility	1. Please confirm grid is lost or not. 2. Make sure the grid connection well. 3. Make sure the breakers on grid side are on
Output High DCI	Output DC current too high. Please refer to the local grid standard for disconnection time when the output DC current is too high.	1. Restart SPA series. 2. Please contact Growatt service center if restart can't solve the problem.
Bat Voltage High	Battery Voltage higher than 60V.	1. Make sure the battery voltage is in the range of specification or not. 2. Make sure the battery connection is well 3. Check if battery is really higher than 60V. please disconnect the connection of battery and check inverter.
Bat Voltage Low	Battery Voltage Lower than 42 V	1. Check the real voltage of battery. 2. Make sure the wire between battery and inverter well connected.
BMS Warning:XXX	BMS report warning	1. Check the warning information from lithium battery user manual. 2. Please contact Growatt service center if restart can't solve the problem.
BMS Error:XXX	BMS report error	1. Check the warning information from lithium battery user manual. 2. Please contact Growatt service center if restart can't solve the problem.
EPS Volt Low	EPS output voltage low	1. Check the load of EPS. If overload occurred at the same time, reduce EPS load. 2. Restart inverter again.

Error message		
Error message	Description	Suggestion
Error 411	Internal communication failed	1. Restart SPA series. 2. Please contact Growatt service center if restart can't solve the problem.
Error 417	Sample fault	1. Restart SPA series. 2. Please contact Growatt service center if restart can't solve the problem.
Error 418	DSP and COM firmware version mismatch, system fault.	1. Read DSP and COM firmware version from LCD or shinebus. 2. Check if the firmware is correct.
Error 303	Inverter L N reversed or ground failed	1. Make sure the L line and N line is not reversed. 2. Make sure the PE is well connected.
Error 405	Relay fault	1. Restart SPA series. 2. Please contact Growatt service center if restart can't solve the problem.
Error 407	Autotest failed(only in Italy)	1. Restart SPA series. 2. Please contact Growatt service center if restart can't solve the problem.
OP Short Fault	EPS Output Short Fault	1. Check the load of EPS. 2. Check the output of EPS. Especial not connect to Grid.
NTC Open	Internal NTC fault	Please contact Growatt service center.
Error 406	Model set up not meet with certification	Please check model set or check the DIP setting.
Error 408	Temperature over range	Please check the temperature is in the range of specification or not.

Table 9.1

10 EU Declaration of Conformity

With the scope of EU directives:

- 2014/35/EU Low Voltage Directive (LVD)
- 2014/30/EU Electromagnetic Compatibility Directive (EMC)
- 2011/65/EU RoHS Directive and its amendment (EU)2015/863

Shenzhen Growatt New Energy Technology Co. Ltd confirms that the Growatt inverters and accessories described in this document are in compliance with the above mentioned EU directives. The entire EU Declaration of Conformity can be found at www.ginverter.com.

Warranty 11

The factory warranty card is enclosed with the package, please keep the warranty card well, warranty card can be download at www.ginverter.com, when user need warranty service during the warranty period, the user must provide a copy of invoice, warranty card, and ensure the nameplate of the inverter is legible.

Otherwise, Growatt has the right to refuse to provide the warranty service.

12 Decommissioning

12.1 Dismantling the energy storage

- Turn the switch off in turn of Grid and battery.
- Waiting until LED and LCD display have gone out, the SPA is shut down completely.

	<p>Watch out the SPA's shell heat and prevent to scald. Wait 20 minutes until the SPA cooling and then to disassembly!</p>
---	--

- Unscrew all the connecting cable.
- Unscrew the radiator and wall-mounted anchor screw and then take down the machine from wall.

12.2 Packing the SPA inverter

Usually placed SPA inverter in the packing box with tape sealing. If the SPA inverter cannot reoccupy, You can choose a cheap carton for packaging. Carton requirements must meet the size of the inverter and can support energy storage machine overall weight.

12.3 Storing SPA inverter

Store SPA series in a dry place where ambient temperatures are always between -25°C and +60°C.

12.4 Disposing of the SPA inverter

	<p>Do not dispose of SPA inverter together with household waste. Please accordance with the disposal regulations for electronic waste which apply at the installation site at that time. Ensure that the old unit and, where applicable, any accessories are disposed of in a proper manner.</p>
--	--

Product specification 13

13.1 SPA series energy storage machine product specification

Model	SPA 1000TL BL	SPA 2000TL BL	SPA 3000TL BL
Specification			
Output Data(AC)			
AC nominal power	1000W	2000W	3000W
Max. AC apparent power	1000VA	2000VA	3000VA
Nominal AC voltage (range)	230V (180V-270V)		
AC grid frequency (range)	50Hz / 60Hz (±5Hz)		
Max output current	6A	10A	16A
Power factor(@nominal power)	1		
Adjustable power factor	0.8leading...0.8 lagging		
THDi(nominal power)	<3%		
AC connection	Single phase		
Input Data(AC)			
AC nominal	1000W	2000W	3000W
Max. AC apparent power	1000VA	2000VA	3000VA
Nominal AC voltage (range)	230V (180V-270V)		
AC grid frequency (range)	50Hz / 60Hz (±5Hz)		
Max input current	6A	10A	16A
Power factor(@nominal power)	1		
Adjustable power factor	0.8leading...0.8 lagging		

Stand-alone Data (AC)			
AC nominal output power	1000W	2000W	3000W
Max. AC apparent power	1000VA	2000VA	3000VA
Nominal AC voltage	230Vac		
Nominal AC frequency	50Hz / 60Hz		
Max. output current	6A	10A	16A
THDv(Linear Load)	<3%		
Switch time	<0.5s		
Battery Data (DC)			
Battery voltage range	42~59V		
Recommended battery voltage	48V		
Max charging and discharging current	24A		
Continous charging and discharging current	24A		
Type of battery	Lithium / Lead-acid		
Capacity of battery	2.4~19.2kWh		
Efficiency			
Max. Charge efficiency	92.0%	92.5%	93.0%
Max. Discharge efficiency	92.5%	93.0%	93.5%
Protection Devices			
BAT reverse protection	yes		
AC surge protection	yes		
AC short-circuit protection	yes		

Ground fault monitoring	yes
Grid monitoring	yes
Anti-islanding protection	yes
General Data	
Dimensions (W / H / D) in mm	428*474*178
Weight	18.6kg
Operating temperature range	- 25°C ...+60°C with derating above 45°C
Noise emission (typical)	≤ 25 dB(A)
Altitude	2000m
Self-Consumption(standby)	< 4 W
Topology	HF transformer
Cooling	Natural
Protection degree	Ip65
Relative humidity	100%
AC connection	Connector
BAT connection	Screw
BAT connection	Screw
Interfaces	
Display	LCD
Rs485/ USB /CAN	yes /yes /yes
RF/Wi-Fi/GPRS/	opt/opt/opt/
Warranty: 5 years / 10 years	yes /opt

Certificates and approvals	
Grid regulation	CEI0-21,G98,G100,AS/NZS4777.2,VDE-AR-N4105,VDE0126-1-1,EN50438,TR3.3.1,IEC62116,IEC61727,UTEC 15-712
EMC	EN61000-6-1,EN61000-6-3
Safety	IEC62477-1, IEC 62040-1

Table 13.1

13.2 Torque

Upper cover screws	1.3Nm(10.8 1bf.in)
Shell and RS232screws	0.7Nm(6.2 1bf.in)
DC connector	1.8Nm(16.0 1bf.in)
M6 screwdriver	2Nm(18 1bf.in)
Grounding screw	2Nm(18 1bf.in)

Table 13.2

13.3 Appendix

The following chart is the energy storage machine optional appendix list, if there is a need please contact the Growatt New Energy Technology Co., Ltd or dealer orders. (P/N is only for reference and it may be changed).

Name	Description	Growatt P/N
Shine link	Used for data record in EU	MR00.0007202
	Used for data record in Australia	MR00.0006102
Shine Wi-Fi-S	COM interface	MR00.0008601
GRRS	COM interface	MR00.0009601
SPM(Single phase meter)	Rs485 meter sensor of Eastron	MR00.0008800

SPM(Single phase meter)	Rs485 meter sensor of CHNT	MR00.0010800
TPM(three phase meter)	Rs485 meter sensor (standard)	MR00.0008300
	Rs485 meter sensor (for Italy)	MR00.0008400
EPS Changeover Switch	On-Grid and Off-Grid transfer switch	TV03.0001200
		TV03.0003100

Table 13.3

Note: Growatt P/N Code will be updated regularly. If necessary, please contact customer service to obtain the latest P/N Code.

14 Contact

If you have technical problems about our products, contact the Growatt Service line or dealer. We need the following information in order to provide you with the necessary assistance:

- SPA inverter Serial number.
- SPA inverter module information.
- SPA inverter communication mode.
- SPA inverter fault information code.
- SPA inverter Display content.
- The manufacturer and model of the battery.
- Battery capacity and connection mode.

Shenzhen Growatt New Energy Technology Co.,LTD
No.28 Guangming Road, Shiyan Street, Bao'an District, Shenzhen, PR.China
T : +86 0755 2747 1942
E : service@ginverter.com
W : www.ginverter.com