

**EASY  
SPACE**

## **4 Layer Single Drawer**

Dimension:  
374 x 516 x 650 mm

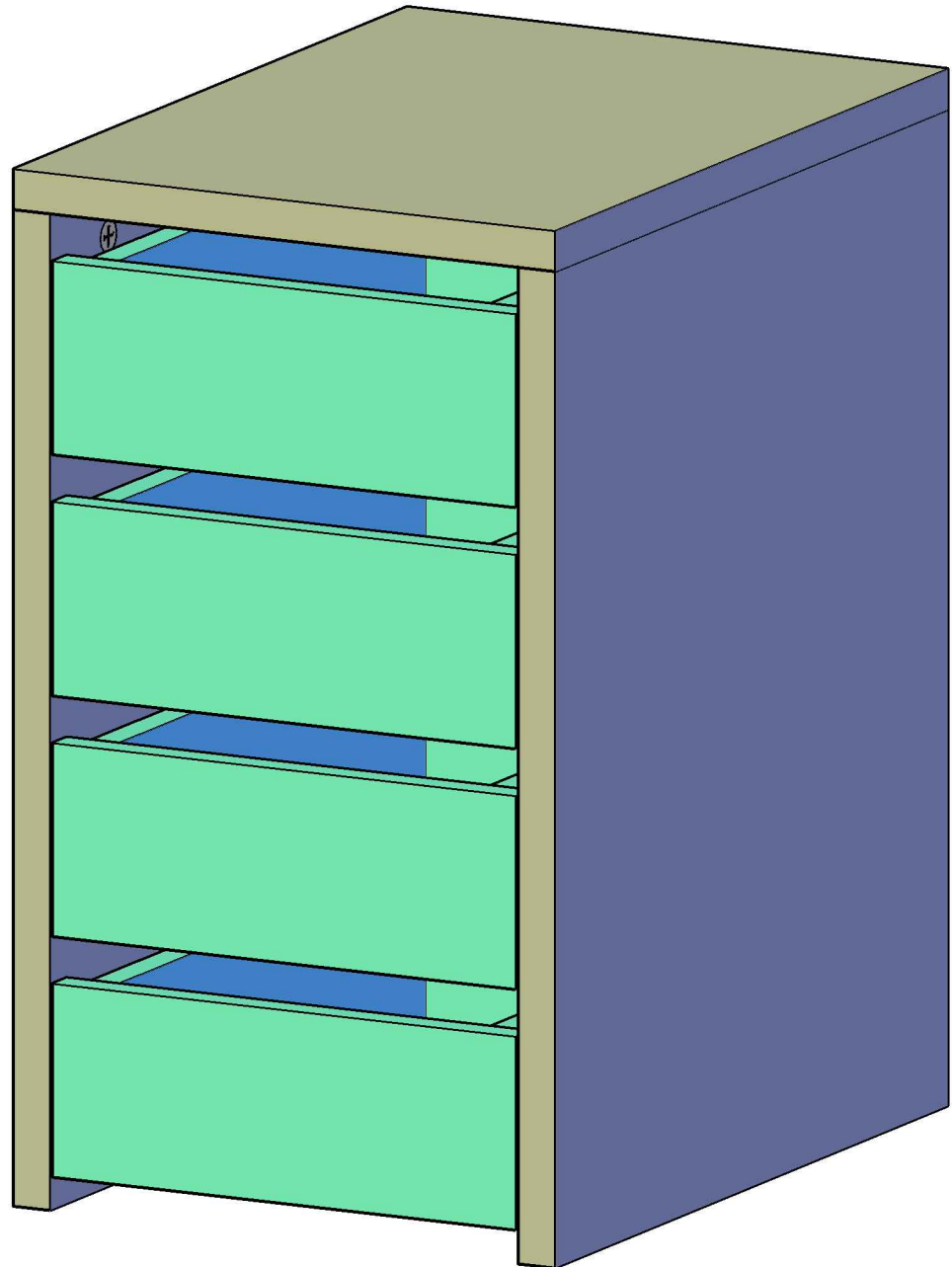

# Assembly Guide

Step 1

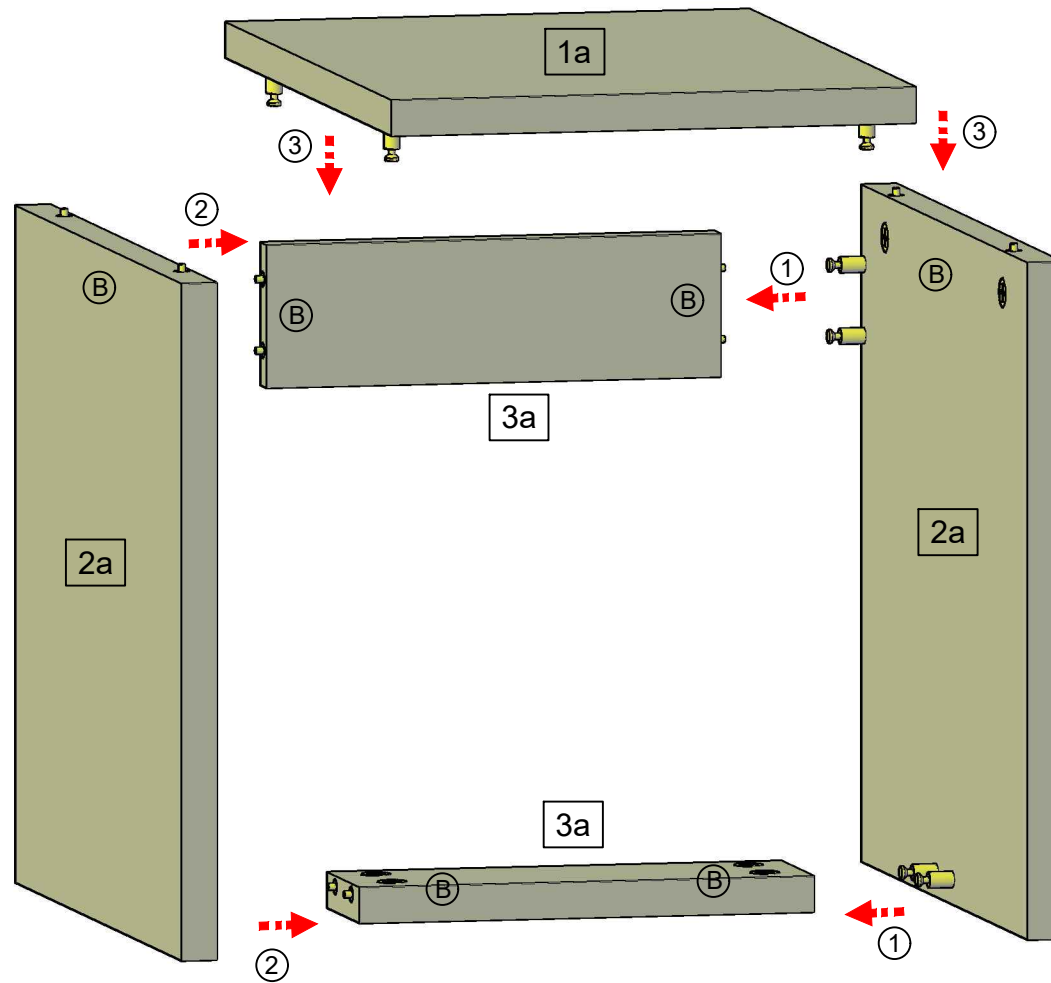

## Parts List:

1a. Top Panel Board x 1pc.

2a. Left & Right Panel Board x 2pcs.

3a. Base Panel Board x 2pcs.

1b. Drawer Left & Right Panel Board x 8pcs.

2b. Drawer Front & Back Panel Board x 8pcs.

3b. Drawer Bottom Panel Board x 4pcs.

# Assembly Guide

## Drawer Assembly Guide

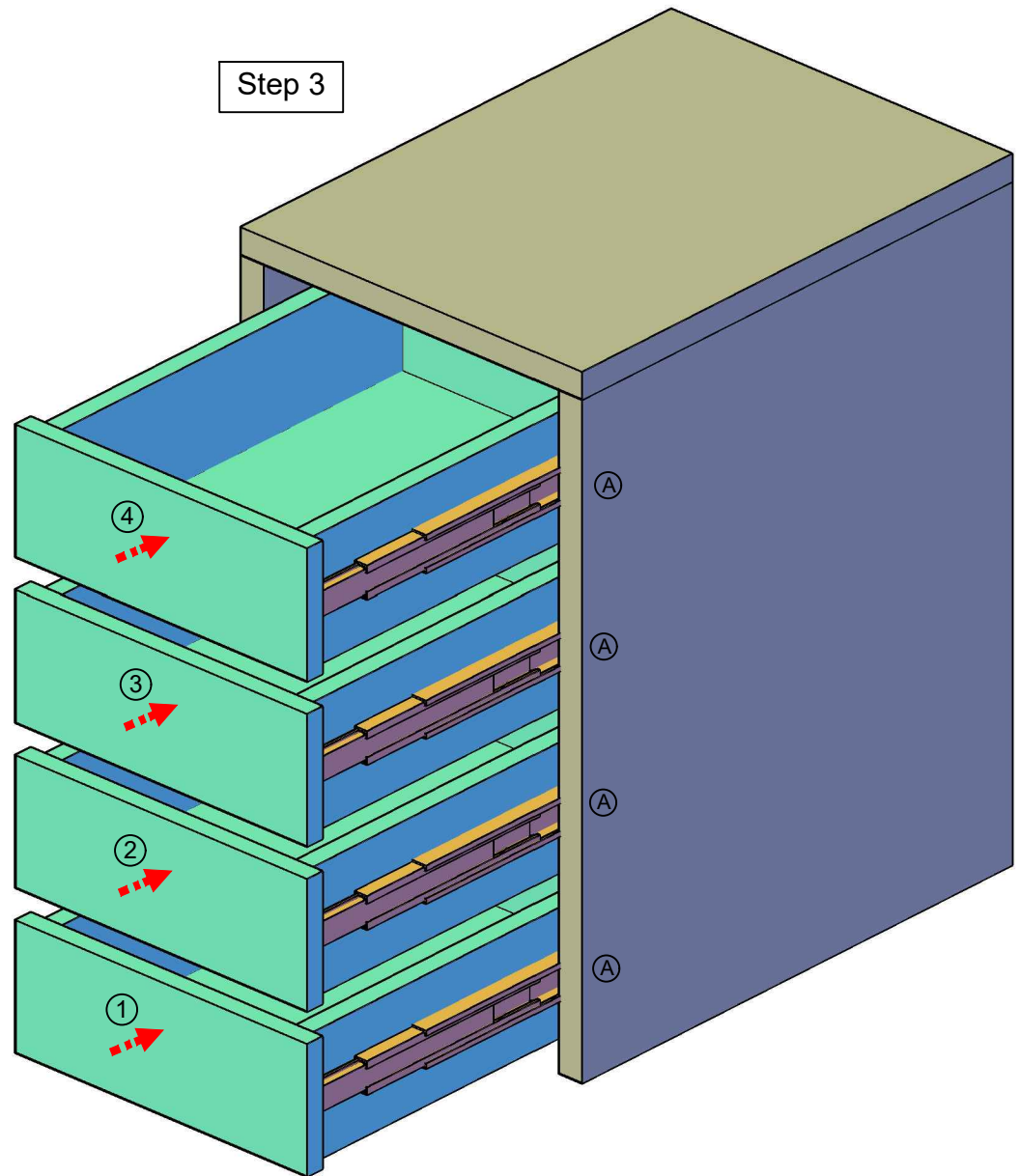
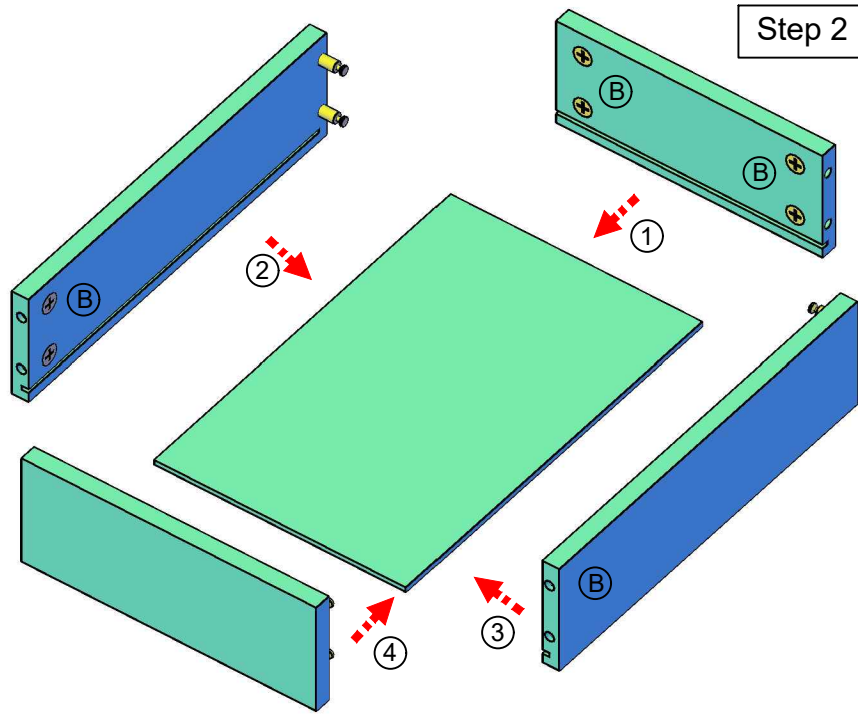

### ACCESSORIES:

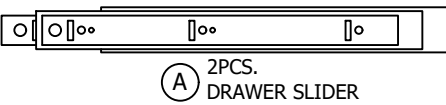
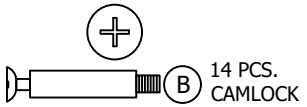

### HOW TO USE CAMLOCK & PIN:

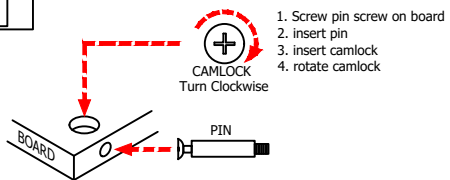

### TOOLS:

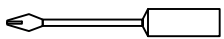

SCREW DRIVER